

Altivar 32

Variable speed drives for
synchronous and asynchronous motors

Modbus TCP - EtherNet/IP Communication Manual

03/2010



Schneider
Electric

The information provided in this documentation contains general descriptions and/or technical characteristics of the performance of the products contained herein. This documentation is not intended as a substitute for and is not to be used for determining suitability or reliability of these products for specific user applications. It is the duty of any such user or integrator to perform the appropriate and complete risk analysis, evaluation and testing of the products with respect to the relevant specific application or use thereof. Neither Schneider Electric nor any of its affiliates or subsidiaries shall be responsible or liable for misuse of the information contained herein. If you have any suggestions for improvements or amendments or have found errors in this publication, please notify us.

No part of this document may be reproduced in any form or by any means, electronic or mechanical, including photocopying, without express written permission of Schneider Electric.

All pertinent state, regional, and local safety regulations must be observed when installing and using this product. For reasons of safety and to help ensure compliance with documented system data, only the manufacturer should perform repairs to components.

When devices are used for applications with technical safety requirements, the relevant instructions must be followed.

Failure to use Schneider Electric software or approved software with our hardware products may result in injury, harm, or improper operating results.

Failure to observe this information can result in injury or equipment damage.

© 2010 Schneider Electric. All rights reserved.

Table of Contents



	Safety Information	6
	About the Book	7
Chapter 1	Presentation	9
	Overview	10
	Transparent Ready	10
	Modbus TCP - EtherNet/IP Communication Card Features Overview	11
	Modbus TCP	11
	EtherNet/IP	12
	TCP/IP and Ethernet Features	12
	Webserver	12
	Notation	13
Chapter 2	Hardware Setup	14
	Hardware Presentation	15
	Firmware and EDS Version Compatibility	15
	Installation	15
	Wiring	18
	Installation Topology	19
	LED's Indicators	20
Chapter 3	Configuration and Parameters	22
	Network Settings	23
	Modbus TCP Settings	25
	FDR Settings	28
	EtherNet/IP Settings	29
	Monitoring of Communication Channels	30
Chapter 4	Configuration of the Drive Commands Settings	32
	Configuration of the Drive for Operation in I/O Profile	33
	Configuration of the Drive for Operation With CiA402 Profile in Combined Mode	34
	Configuration of the Drive for Operation With CiA402 Profile in Separate Mode	34
Chapter 5	Network Layer Supported Functions/Protocols	35
	ARP, ICMP and IP Protocol	35
Chapter 6	Transport Layer Protocols	37
	TCP and UDP Protocol	37
Chapter 7	Modbus TCP Features	39
	Modbus TCP Frames	40
	ATV32 and VW3 A3 616: Modbus Servers	40
	Supported Modbus Functions	41
	Application Profile with Modbus TCP	42
	Configuring Communication Detected Fault Management	42
	Configuring Monitor Parameters	44
Chapter 8	Controlling an ATV32 From Modbus TCP (M340)	45
	Description of the Configuration	46
	Configuration of the Ethernet Module (NOE 100 or NOE 110)	48
	Monitor and Control the Exchanges	51

	Modbus Messaging	52
Chapter 9	EtherNet/IP Features	53
	VW3 A3 616 and EtherNet/IP Overview	54
	Cyclical Exchanges (Implicit Exchanges)	55
	Messaging (Explicit Exchanges)	59
	Detected Fault Management	60
Chapter 10	ATV32 Configuration in ETC100	61
	Procedure	62
	Explicit Messaging	67
Chapter 11	Profiles	69
	Definition of a Profile	70
	Functional Profiles Supported by the Altivar 32	71
Chapter 12	CiA®402 - IEC61800-7 Functional Profile	72
	Functional Description	73
	CiA402 State Chart	74
	Description of States	75
	Summary	76
	Control Word (CMD)	77
	Stop Commands	78
	Assigning Control Word Bits	78
	Status Word (EtA)	79
	Starting Sequence	80
	Sequence for a Drive Powered by the Power Section Line Supply	81
	Sequence for a Drive With Separate Control Section	83
	Sequence for a Drive With Line Contactor Control	86
Chapter 13	CIP Objects Overview	88
	Objects in the AC/DC Drive Device	89
	Object 28hex (Motor Data)	89
	Object 29hex (Control Supervisor)	90
	Object 2Ahex (AC/DC Drive)	91
Chapter 14	Transparent Ready Features	92
	Presentation	93
	Startup Detailed Behavior	94
	FDR Operation Behavior	95
	FDR Settings	96
	Local Configuration	97
	Downloaded Configuration	98
Chapter 15	Embedded Webserver	100
	Overview	101
	Connexion to the Webserver	101
	Pages Description	102
	FTP Server	111
Chapter 16	Integration in the EtherNet/IP Network	112
	Installing the EDS File	113
	Configuration of the EtherNet/IP Module in the Rockwell PLC	115
	Configuring the Implicit Exchanges	116
	Configuration of the Communication Scanner	118
	Configuration of the Communication Period	119
	Explicit Messaging	120
	Assembly Selection	122
Chapter 17	CIP Objects	123
	Supported Object Classes	124

Identity Object (F1h)	124
Message Router Object (F2h)	127
TCP/IP Interface Object (F5h)	127
Ethernet Link Object (F6h)	130
Assembly Object (04 hex)	131
Connection Manager Object (06h)	133
Motor Data Object (28h)	135
Control Supervisor Object (29h)	136
AC/DC Drive Object (2Ah)	137
Application Object (70h to C7h) / Explicit Messaging	140

Safety Information

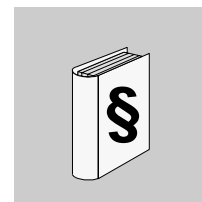

Important Information

NOTICE

Read these instructions carefully, and look at the equipment to become familiar with the device before trying to install, operate, or maintain it. The following special messages may appear throughout this documentation or on the equipment to warn of potential hazards or to call attention to information that clarifies or simplifies a procedure.



The addition of this symbol to a Danger or Warning safety label indicates that an electrical hazard exists, which will result in personal injury if the instructions are not followed.



The addition of this symbol to a Danger or Warning safety label indicates that an electrical hazard exists, which will result in personal injury if the instructions are not followed.

▲ DANGER

DANGER indicates an imminently hazardous situation, which, if not avoided, **will result** in death or serious injury.

▲ WARNING

WARNING indicates a potentially hazardous situation, which, if not avoided, **can result** in death, serious injury or equipment damage.

▲ CAUTION

CAUTION indicates a potentially hazardous situation, which, if not avoided, **can result** in injury or equipment damage.

CAUTION

CAUTION, used without the safety alert symbol, indicates a potentially hazardous situation which, if not avoided, **can result** in equipment damage.

PLEASE NOTE

The word “drive” as used in this manual refers to the controller portion of the adjustable speed drive as defined by NEC.

Electrical equipment should be installed, operated, serviced, and maintained only by qualified personnel. No responsibility is assumed by Schneider Electric for any consequences arising out of the use of this material.

About the Book

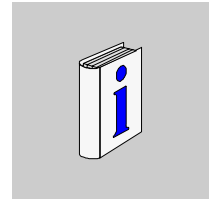

At a Glance

Document Scope

The purpose of this document is to:

- show you how to install the Ethernet fieldbus on your Altivar 32,
- show you how to configure the Altivar 32 to use Ethernet for monitoring and control,
- provide examples of setup using SoMachine and Unity.

NOTE: Read and understand this document and all related documents (see below) before installing, operating, or maintaining your ATV32.

Validity Note

This documentation is valid for the Altivar 32 Ethernet fieldbus.

Related Documents

Title of Documentation	Reference Number
ATV32 Quick Start	S1A41715
ATV32 Installation manual	S1A28686
ATV32 Programming manual	S1A28692
ATV32 Modbus manual	S1A28698
ATV32 CANopen® manual	S1A28699
ATV32 Communication parameters	S1A44568
ATV32 Atex manual	S1A45605
ATV32 Safety manual	S1A45606
ATV32 other option manuals: see www.schneider-electric.com	

You can download the latest versions of these technical publications and other technical information from our website at www.schneider-electric.com.

Product Related Information

⚠ DANGER

UNINTENDED EQUIPMENT OPERATION

- Read and understand this manual before installing or operating the Altivar 32 drive.
- Any changes made to the parameter settings must be performed by qualified personnel..

Failure to follow these instructions will result in death or serious injury.

⚠ ⚠ DANGER

HAZARD OF ELECTRIC SHOCK, EXPLOSION OR ARC FLASH

- Read and understand this manual before installing or operating the Altivar 32 drive. Installation, adjustment, repair, and maintenance must be performed by qualified personnel.
- The user is responsible for compliance with all international and national electrical code requirements with respect to grounding of all equipment.
- Many parts of this drive, including the printed circuit boards, operate at the line voltage. **DO NOT TOUCH.** Use only electrically insulated tools.
- **DO NOT** touch unshielded components or terminal strip screw connections with voltage present.
- **DO NOT** short across terminals PA/+ and PC/- or across the DC bus capacitors.
- Before servicing the drive:
 - Disconnect all power, including external control power that may be present.
 - Place a “DO NOT TURN ON” label on all power disconnects.
 - Lock all power disconnects in the open position.
 - **WAIT 15 MINUTES** to allow the DC bus capacitors to discharge.
 - Measure the voltage of the DC bus between the PA/+ and PC/- terminals to ensure that the voltage is less than 42 Vdc.
 - If the DC bus capacitors do not discharge completely, contact your local Schneider Electric representative. Do not repair or operate the drive
- Install and close all covers before applying power or starting and stopping the drive.

Failure to follow these instructions will result in death or serious injury.

⚠ WARNING

DAMAGE DRIVE EQUIPMENT

Do not operate or install any drive or drive accessory that appears damaged.

Failure to follow these instructions can result in death, serious injury, or equipment damage.

⚠ WARNING

LOSS OF CONTROL

- The designer of any control scheme must
 - consider the potential failure modes of control paths and,
 - for certain critical control functions, provide a means to achieve a safe state during and after a path failure.

Examples of critical control functions are emergency stop and overtravel stop.

- Separate or redundant control paths must be provided for critical control functions.
- System control paths may include communication links. Consideration must be given to the implications of unanticipated transmission delays or failures of the link.⁽¹⁾

Failure to follow these instructions can result in death, serious injury, or equipment damage.

(1) For additional information, refer to NEMA ICS 1.1 (latest edition), “Safety Guidelines for the Application, Installation, and Maintenance of Solid State Control” and to NEMA ICS 7.1 (latest edition), “Safety Standards for Construction and Guide for Selection, Installation and Operation of Adjustable-Speed Drive Systems.”

Presentation



1

What's in this Chapter?

This chapter contains the following topics:

Topic	Page
Overview	10
Transparent Ready	10
Modbus TCP - EtherNet/IP Communication Card Features Overview	11
Modbus TCP	11
EtherNet/IP	12
TCP/IP and Ethernet Features	12
Webserver	12
Notation	13

Overview

The VW3 A3 616 is a dual port Ethernet communication module that can be used in the following two industrial communication protocols: Modbus TCP and EtherNet/IP. In addition of the communication services provided by each protocol, the VW3 A3 616 provides a set of common services at the Ethernet and TCP/IP level. The VW3 A3 616 offers also an embedded web server (English) which offers comfortable monitoring and commissioning functions directly from a standard web browser.

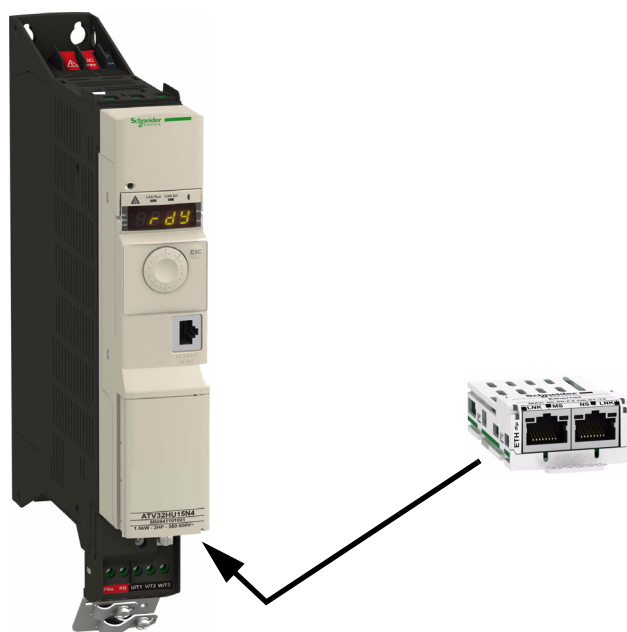

Basic Overview According to the Simplified TCP/IP Model

Application	Modbus TCP - EtherNet/IP
Transport	TCP / UDP
Network	IP
Link	Ethernet

Transparent Ready

Introduced by Schneider Electric, the Transparent Ready concept enables transparent communication between control system devices, production and management. Network technologies and the associated new services are used to share and distribute data between sensors, PLCs, workstations and third-party devices in an increasingly efficient manner. Web servers embedded in the network components and control system devices can be used to:

- Access configuration data transparently
- Perform remote diagnostics
- Incorporate simple human/machine interface functions

This concept is based on the Ethernet TCP/IP industrial standard which proposes a single network that meets most communication requirements from sensors/actuators to production management systems. Where a variety of communication systems is usually required, Transparent Ready standard technologies can result in significant cost savings in the areas of definition, installation, maintenance or training.

Transparent Ready is based on:

- Ethernet TCP/IP-based services meeting control system requirements in terms of functions, performance and quality of services
- Products including several ranges of PLC, distributed I/O, industrial terminals, variable speed drives, gateways and an increasing number of partner products
- The ConneXium range of cabling accessories: hubs, switches, cables adapted to the environment and to the requirements of industrial conditions.

Modbus TCP - EtherNet/IP Communication Card Features Overview

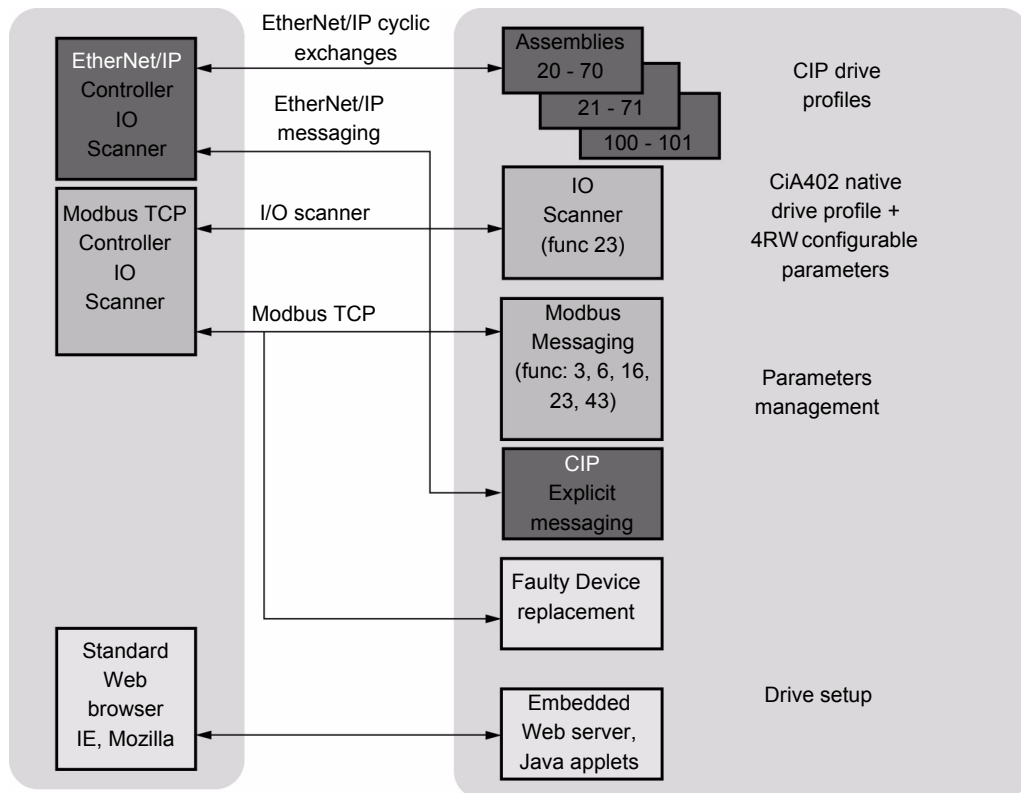

Modbus TCP

The Modbus application layer is standard. Thousands of manufacturers are already implementing this protocol. Many have already developed a Modbus TCP/IP connection and numerous products are currently available. With the simplicity of its protocol and the fast Ethernet throughput data rate of 100 Mbps, Modbus TCP/IP achieves excellent performance.

EtherNet/IP

EtherNet/IP is a fieldbus based on TCP and UDP. EtherNet/IP extends Ethernet by an advanced industrial protocol (CIP, Common Industrial Protocol) as an application layer for automation applications in this way, Ethernet is excellently suited for industrial control. Products from different manufacturers can be networked without the need for special interface adaptation.

TCP/IP and Ethernet Features

The product supports the following functions via:

- Automatic IP address assignment via BOOTP or DHCP
- Automatic configuration data via FDR (only in Modbus TCP)
- Commissioning via commissioning software SoMove
- Diagnostics and configuration via integrated web server

Webserver

The standard Web server (English only) provides access to the following pages:

- Altivar Viewer
- Data Viewer
- Ethernet
- Security
- Etc...

Notation

Drive Terminal Displays

The graphic display terminal (to be ordered separately - reference VW3 A1 101) menus are shown in square brackets.

Example: **[COMMUNICATION]**

The integrated 7-segment display terminal menus are shown in round brackets.

Example: **(L D P -)**

Parameter names are displayed on the graphic display terminal in square brackets.

Example: **[Fallback speed]**

Parameter codes are displayed on the integrated 7-segment display terminal in round brackets.

Example: **(L F F)**

Formats

In this manual, hexadecimal values are written as follows: 16#

Binary values are written as follows: 2#

Abbreviations

Req. = Required

Opt. = Optional

Hardware Setup



2

What's in this Chapter?

This chapter contains the following topics:

Topic	Page
Hardware Presentation	15
Firmware and EDS Version Compatibility	15
Installation	15
Wiring	18
Installation Topology	19
LED's Indicators	20

Hardware Presentation

The following figure presents the Modbus TCP - EtherNet/IP module:



Firmware and EDS Version Compatibility

Only VW3 A3 616 option cards, with minimum 1.2IE01 firmware version, are compliant with ATV32.

NOTE: Check the firmware version, on the packaging label (on the right part of the label).

The associated EDS is the following SE_ET_ATV32_0102E.eds. This file is available on www.schneider-electric.com.

Installation

Check that the card catalog number marked on the label is the same as that on the delivery note corresponding to the purchase order.

Remove the communication module from its packaging and check that it has not been damaged in transit.

CAUTION

RISK OF DAMAGE TO THE DRIVE

Install only communication modules designed for ATV32. See references in the catalog.

Failure to follow these instructions can result in equipment damage.

⚠️ ⚠️ DANGER

HAZARD OF ELECTRIC SHOCK, EXPLOSION OR ARC FLASH



Read and understand the precautions in "About the Book" on page 7 before performing the procedure in this section.

Failure to follow these instructions will result in death or serious injury.

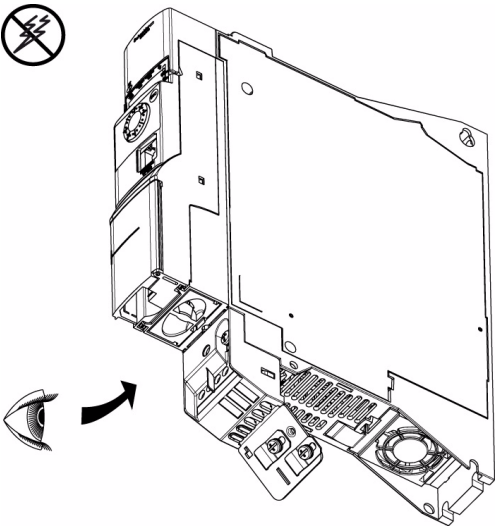
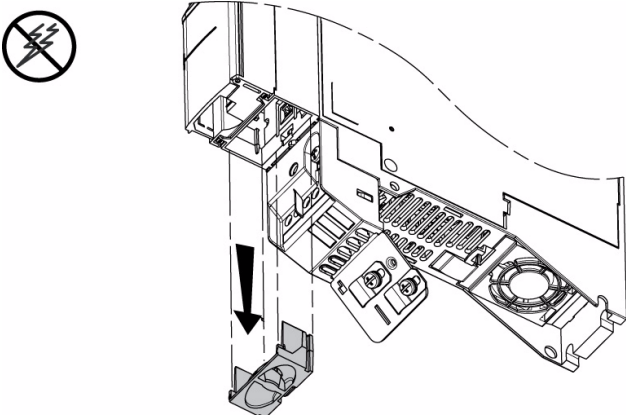
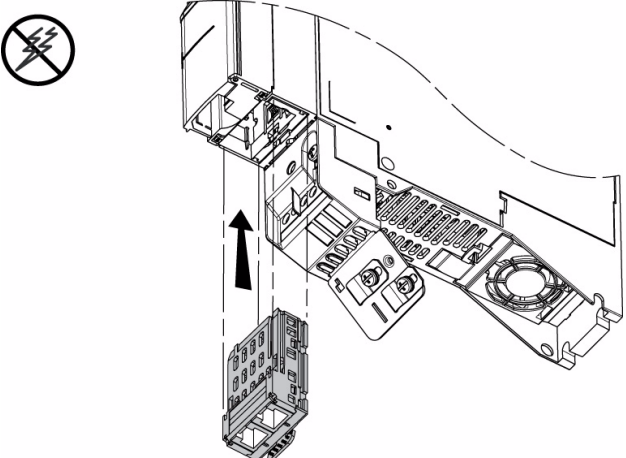
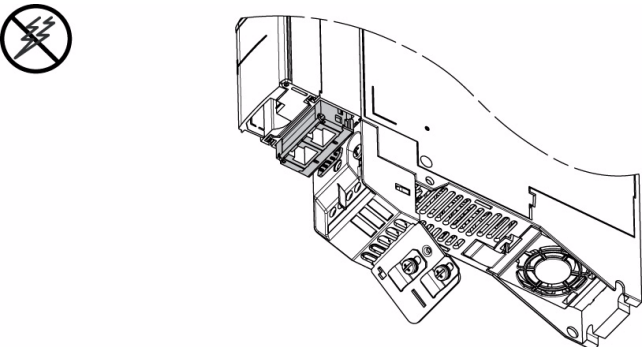
Install the Modbus TCP - EtherNet/IP module in ATV32 as follows:

Step	Action	Comment
1	Ensure that the power is off. Locate the option card port on the bottom of the ATV32.	
2	Extract the cover.	
3	Insert the VW3 A3 616 module.	
4	Check that the module is correctly inserted and locked mechanically in the drive.	

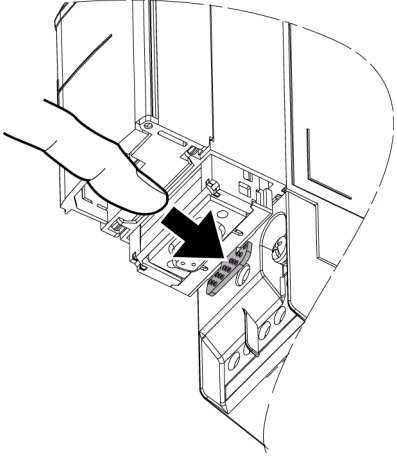
Extract the communication module as follows:

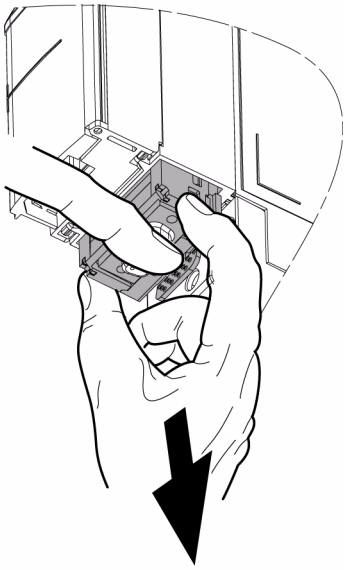
Step	Action	Comment
1	Ensure that the power is off. Press the strip.	 
2	Extract the module while maintaining the strip pressed.	 

Wiring

The VW3 A3 616 option card is equipped with 2 RJ45 female sockets for the Ethernet connection.

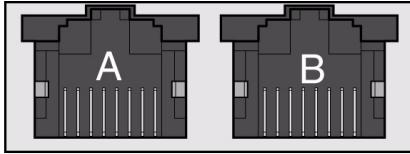

8 7 6 5 4 3 2 1 8 7 6 5 4 3 2 1

- Use equipotential bonding conductors,
- Use pre-assembled cables to reduce the wiring mistakes,
- Verify that wiring, cables and connected interfaces meet the PELV requirements.

The following table describes the pin out of each RJ45:

Pin	Signal	Meaning
1	Tx+	Ethernet transmit line +
2	Tx-	Ethernet transmit line -
3	Rx+	Ethernet receive line +
4	-	-
5	-	-
6	Rx-	Ethernet receive line -
7	-	-
8	-	-

Installation Topology

The VW3 A3 616 option card, with its 2 RJ45 connector, enables several wiring solutions:

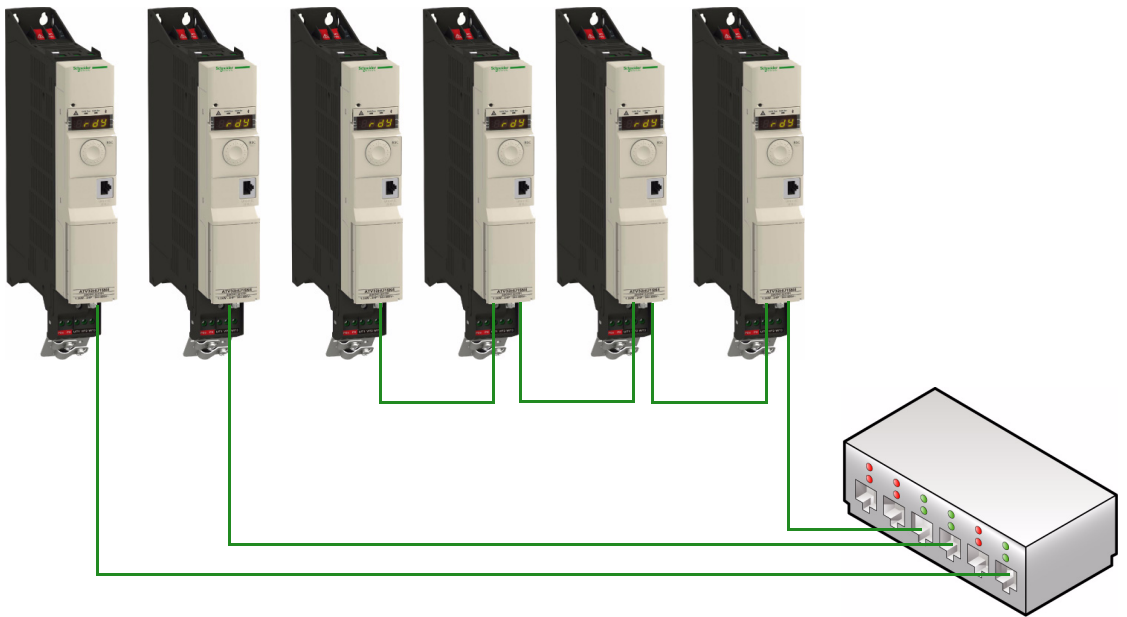

The following configuration **MUST NOT** be used:

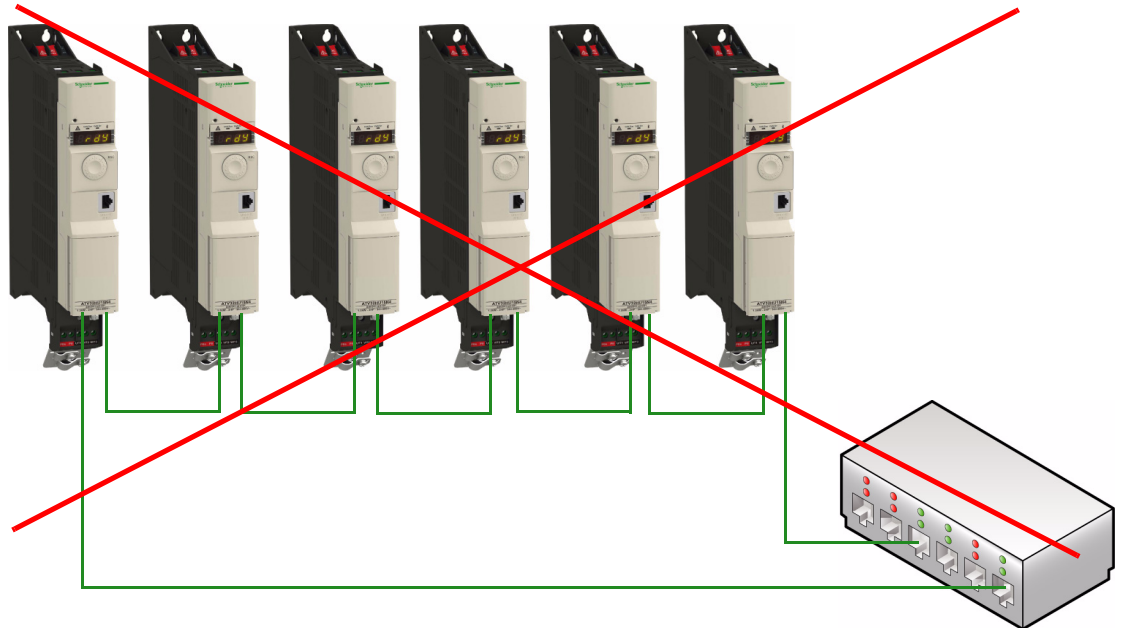

LED's Indicators

The following figures describes the LEDs status module:

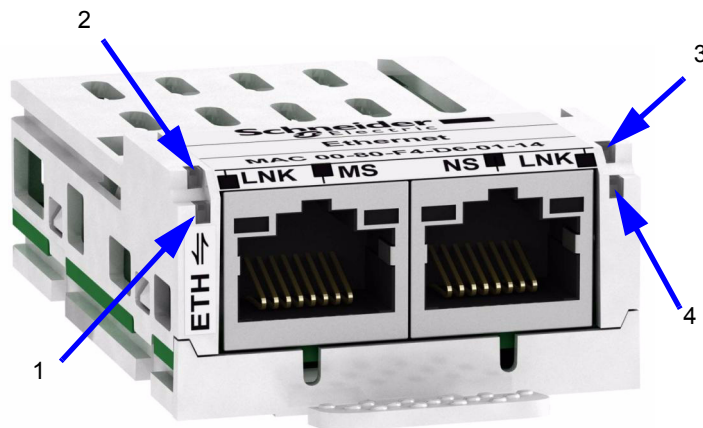

LED	Description
LNK (1)	Connection A port
MS (2)	Module status
NS (3)	Network status
LNK (4)	Connection B port

LEDs 1 and 4: Link Activity

These LEDs indicate the status of the Ethernet port A (1) and Ethernet port B (4):

	Color & Status	Description
EtherNet/IP & Modbus TCP	OFF	No link
	Flashing Green/Yellow	Power up testing
	Green ON	Link at 100Mbps
	Yellow ON	Link at 10 Mbps
	Green Blink	Activity at 100 Mbps
	Yellow Blink	Activity at 10 Mbps

LED 2: Module Status

This LED indicates the status of the module status:

	Color & Status	Description
EtherNet/IP	OFF	No power is supplied to the device
	Flashing Green/Red	Power up testing
	Green ON	The device is operating correctly.
	Green flashing	The device has not been configured
	Red flashing	The device has detected a recoverable minor detected fault
	Red on	The device has detected a non-recoverable major detected fault
Modbus TCP	OFF	The device does not have an IP address or powered off
	Flashing Green/Red	Power up testing
	Green ON	The device is ready
	Green flashing	The device is not ready (waiting for cable connection,...)
	Red flashing	The device has detected a (C n F)
	Red ON	The device has detected a (IL F)

LED 3: Network Status

This LED indicates the status of the module status:

	Color & Status	Description
EtherNet/IP	OFF	The device does not have an IP address or powered off
	Flashing Green/Red	Power up testing
	Green ON	The device has at least one established connection
	Green flashing	The device has no at least one established connection
	Red flashing	One or more of the connections in which this device is the target has timed out. This shall be left only if all time out connections are reestablished or if the device is reset.
	Red on	The device has detected that its IP address is already in use
Modbus TCP	OFF	The device does not have an IP address or powered off
	Flashing Green/Red	Power up testing
	Green ON	At least one port is connected and an IP ^o address has been obtained
	Green flashing 3 times	All ports are unplugged, but the card has an IP address
	Green flashing 4 times	Detected error: duplicate IP address
	Green flashing 5 times	The card is performing a BOOTP or DHCP sequence

LED Behavior Detail

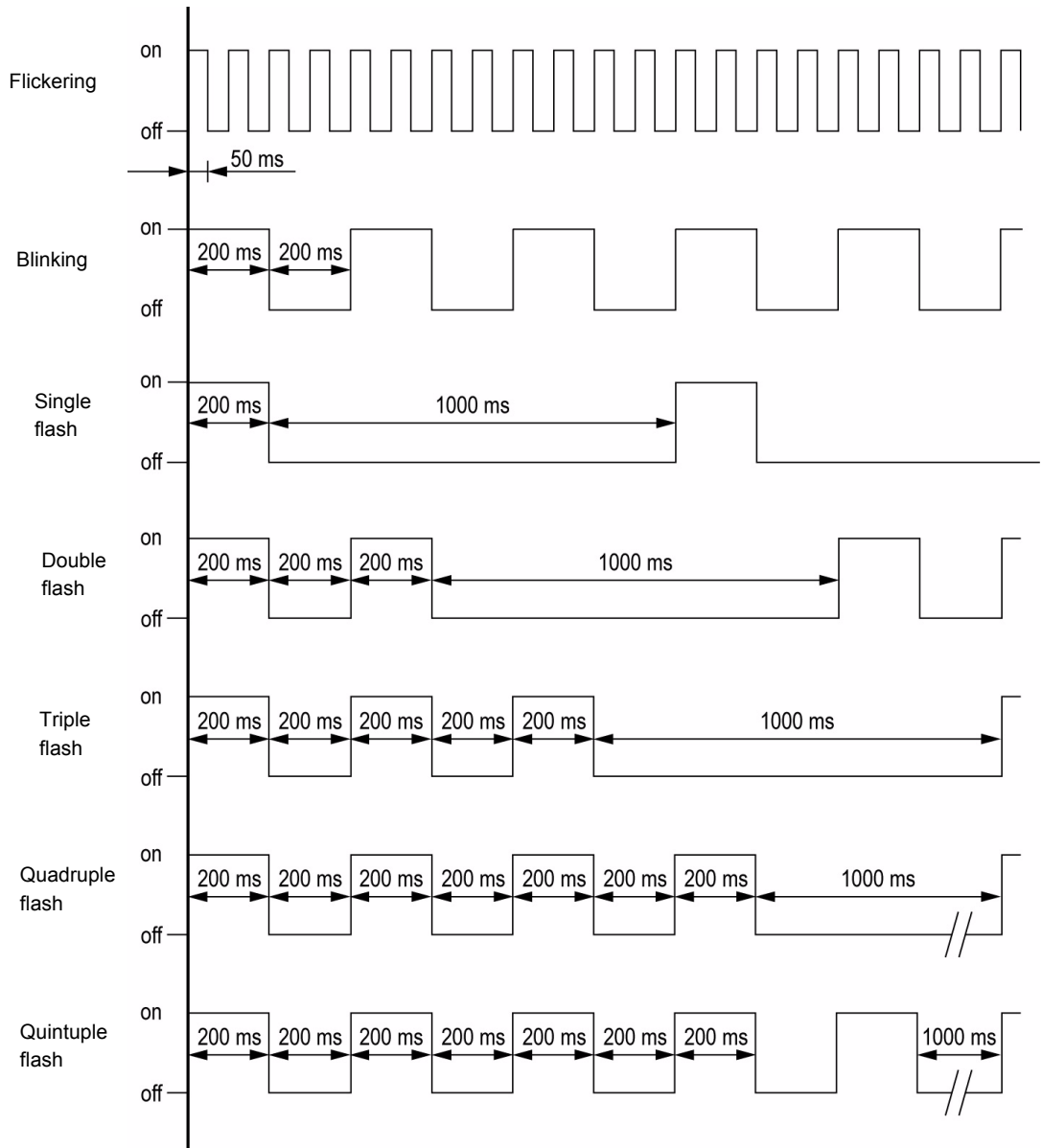

Configuration and Parameters

3

Overview

This chapter describes the parameters of the VW3 A3 616 module. These parameters are described here according to the local HMI or the Graphic keypad. These settings are also possible from SoMove or from the embedded web server.

What's in this Chapter?

This chapter contains the following topics:

Topic	Page
Network Settings	23
Modbus TCP Settings	25
FDR Settings	28
EtherNet/IP Settings	29
Monitoring of Communication Channels	30

Network Settings

The parameters are accessible via **[CONFIGURATION]** (CONF -), **[FULL]** (FULL -), **[COMMUNICATION]** (COM -) menu and **[COMMUNICATION CARD]** (Cb -) submenu.

Parameter Description (HMI mnemonic)	Range or Listed Values	Default	Long Name	Short Name	Access	Parameter Number
[Ethernet protocol] (ETH) This parameter defines which protocol is used for implicit exchanges	0: Modbus TCP 1: EtherNet/IP	0	[Modbus TCP]	(MTC) (EIP)	R/W	64241
[Rate setting] (RS) Rate and data settings	0: Autodetect 1: 10 Mbps Full 2: 10 Mbps Half 3: 100 Mbps Full 4: 100 Mbps Half	Auto	[Auto] [10M. full] [10M. half] [100M. full] [100M. half]	(AUT) (10F) (10H) (100F) (100H)	R/W	64251
[IP mode] (IPM) Use this parameter to select the IP address assignment method	0: Man 1: BOOTP 2: DHCP	DHCP	[fixed] [BOOTP] [DHCP]	(MAN) (BOOT) (DHCP)	R/W	64250
[IP card] (IPC) (IPC1)(IPC2)(IPC3)(IPC4) These fields are editable when IP mode is set to Fixed address	0 to 255 for each 4 fields	-	[139.160.069.241]	(139) (160) (069) (241)	R/W	64212 64213 64214 64215
[IP Mask] (IPN) (IPN1)(IPN2)(IPN3)(IPN4) These fields are editable when IP mode is set to Fixed address	0 to 255 for each 4 fields	-	[255.255.254.0]	(255) (255) (254) (0)	R/W	64216 64217 64218 64219
[IP Gate] (IPG) (IPG1)(IPG2)(IPG3)(IPG4) These fields are editable when IP mode is set to Fixed address	0 to 255 for each 4 fields	-	[0.0.0.0]	(0) (0) (0) (0)	R/W	64220 64221 64222 64223
[MAC @] (MAC) MAC address display	[00-80-F4-XX-XX-XX]	-	[00-80-F4-XX-XX-XX]	0080 F4--- XX XXXX	R	64267 64268 64269

NOTE: Before entry begins, the IP address displayed is the active IP address.

Assigning IP Addresses

The drive needs 3 IP addresses:

- The drive IP address.
- The subnet mask.
- The gateway IP address.

These IP addresses can be entered directly: Using the integrated display terminal. Using the graphic display terminal. Or using the SoMove software. They can be provided by:

- A BOOTP server (correspondence between the MAC address and the IP addresses).
- Or a DHCP server (correspondence between Device Name **[DEVICE NAME]** and the IP addresses).

If an IP address other than 0.0.0.0 has been entered using the display terminal or the SoMove software, assignment using a server is disabled.

Entering IP Addresses in the Terminal

In the **[COMMUNICATION]** (C O N -) menu, **[ETHERNET]** (E E H -) submenu, enter the following IP addresses:

- **[IP card]** (I P C 1)(I P C 2)(I P C 3)(I P C 4),
- **[IP Mask]** (I P M 1)(I P M 2)(I P M 3)(I P M 4),
- **[IP Gate]** (I P G 1)(I P G 2)(I P G 3)(I P G 4).

Turn the drive off and then back on again (control voltage if a separate power supply is being used), otherwise the IP addresses are not taken into account.

If this address is modified, the new IP address entered is displayed. This IP address will be effective the next time the drive is turned on.

Configuring BOOTP

The BOOTP service is used to assign IP addresses from the MAC address. The MAC address consisting of 6 hexadecimal digits (00-80-F4-80-xx-yy) must be entered in the BOOTP server. The MAC address appears on the label attached to the Ethernet card.

In the **[COMMUNICATION]** (C O N -) menu, **[ETHERNET]** (E E H -) submenu:

- Leave the IP address **[IP card]** (I P C 1)(I P C 2)(I P C 3)(I P C 4) at the value **[0.0.0.0]** (0)(0)(0)(0).
- Do not enable the FDR service: **[FDR validation]** (F d r U) = **[No]** (n 0).

Modbus TCP Settings

The parameters are accessible via **[CONFIGURATION]** (*C O N F -*), **[FULL]** (*F U L L -*), **[COMMUNICATION]** (*C O M -*) menu and **[COMMUNICATION CARD]** (*C b d -*) submenu.

These settings are only visible when the parameter **[Ethernet protocol]** (*E t h P*) is defined on **[ModbusTCP]** (*M b t P*):

Parameter Description (HMI mnemonic)	Range or Listed Values	Default	Long Name	Short Name	Access	Parameter Number
[MAC @] (<i>M A C</i>) MAC address display	[00-80-F4-XX-XX-XX]	-	[00-80-F4-XX-XX-XX]	0080 F4--- XX XXXX	R	64267 64268 64269
[Rate setting] (<i>r d S</i>)	0: Autodetect 1: 10 Mbps Full 2: 10 Mbps Half 3: 100 Mbps Full 4: 100 Mbps Half	Auto	[Auto] [10M. full] [10M. half] [100M. full] [100M. half]	(R U t D) (I D F) (I D H) (I D D F) (I D D H)	R/W	64251
[Ethernet protocol] (<i>E t h P</i>)	0:Modbus TCP 1:EtherNet/IP	0	[Modbus TCP] [EthernetIP]	(M b t P) (E t I P)	R/W	64241
[IP mode] (<i>I P M</i>) Use this parameter to select the IP address assignment method	0: Man 1: BOOTP 2: DHCP	DHCP	[fixed] [BOOTP] [DHCP]	(M A N U) (b o o t) (d h c p)	R/W	64250
[IP card] (<i>I P C</i>) (I P C 1) (I P C 2) (I P C 3) (I P C 4) These fields are editable when IP mode is set to Fixed address	0 to 255 for each 4 fields	0.0.0.0	[0.0.0.0]	(D) (D) (D) (D)	R/W	64212 64213 64214 64215
[IP Gate] (<i>I P G</i>) (I P G 1) (I P G 2) (I P G 3) (I P G 4) These fields are editable when IP mode is set to Fixed address	0 to 255 for each 4 fields	-	[0.0.0.0]	(D) (D) (D) (D)	R/W	64220 64221 64222 64223
[IP Master] (<i>I P P</i>) (I P P 1) (I P P 2) (I P P 3) (I P P 4) These fields define the address of the device which retains control of the drive	0 to 255 for each 4 fields	0.0.0.0	[0.0.0.0]	(D) (D) (D) (D)	R/W	64234 64235 64236 64237
[IP FDR] (<i>I P F</i>) (I P F 1) (I P F 2) (I P F 3) (I P F 4) These fields displays the served address of the FDR server	0 to 255 for each 4 fields	0.0.0.0	[0.0.0.0]	(D) (D) (D) (D)	R/W	64224 64225 64226 64227
[FDR validation] (<i>F d r U</i>) Enable FDR service	0: no 1: yes	yes	[No] [Yes]	(n D) (Y E S)	R/W	64228
[FDR Action] (<i>F d r A</i>)	IDLE: No command SAVE: save command REST: download command DEL: delete command	IDLE	[IDLE] [SAVE] [REST] [DEL]	(I d L E) (S A V E) (r E S t) (d E L)	R/W	64229
[FDR autosave] (<i>F d r S</i>) Interval for periodic saving of the FDR service	0: no 1: yes	no	[No] [Yes]	(n D) (Y E S)	R/W	64230
[FDRt. autosave] (<i>F d r t</i>)	0 to 9999 minutes	0	[0]	(D)	R/W	64231

Parameter Description (HMI mnemonic)	Range or Listed Values	Default	Long Name	Short Name	Access	Parameter Number
[FDR state] (F d r E) FDR service status	- IDLE: idle state - INIT: initialisation - CONF: configuration - RDY: ready - GET: download the current configuration - SET: save the current configuration - APP: Write the FDR server conf. to the drive - OPE: operational - UCFG: not configured	IDLE	[IDLE] [INIT] [CONF] [RDY] [GET] [SET] [APP] [OPE] [UCFG]	(I d L E) (I N I t) (C O N F) (r d Y) (G E t) (S E t) (A P P) (O P E) (U C F G)	RW	64232
[FDR file error] (F d r F) Enable FDR detected fault management	0: no 1: yes	yes	[No] [Yes]	(n 0) (Y E S)	R/W	64240
[Ethernet local conf] (L C F G) Selection of local or server configuration	0: no 1: yes	no	[No] [Yes]	(n 0) (Y E S)	R/W	64238
[Eth IO scan act] (I O S A) Enable I/O scanner	0: no 1: Yes	-	[No] [Yes]	(n 0) (Y E S)	R/W	64239
[SERVICES] (E W E -) Enable web services	0: No web services 1: Web server enabled	1	-	-	R/W	-
[Ethernet Timeout] (E O U t) Ethernet timeout	0.5 to 60 s 0: disabled	2.0	[2.0s]	(2 . 0)	R/W	64211
[FDR Fault] (F d r d) FDR fault code	- 0: No detected fault - 2: the FDR configuration file is not compatible with the drive type - 3: Detected error reading the FDR configuration file on the server - 4: Detected error writing the configuration file to the server - 7: Time out for receipt of the FDR configuration file from the server - 9: duplicated IP address. - 12: the FDR configuration file is missing - 13: the FDR configuration file deployment on the drive has detected a fault (local detected error) - 14: the configuration file delete request has detected a fault on the FDR server	0	[0] [2] [3] [4] [7] [9] [12] [13] [14]	(0) (2) (3) (4) (7) (9) (1 2) (1 3) (1 4)	R	64233
[Scan.Out1 address] (O C A 1) Scan Out 1 Modbus address	Eligible modbus address	CM	[OCA1]	(O C A 1)	R/W	15421
[Scan.Out2 address] (O C A 2) Scan Out 2 Modbus address	Eligible modbus address	LFRD	[OCA2]	(O C A 2)	R/W	15422
[Scan.Out3 address] (O C A 3) Scan Out 3 Modbus address	Eligible modbus address	0	[OCA3]	(O C A 3)	R/W	15423
[Scan.Out4 address] (O C A 4) Scan Out 4 Modbus address	Eligible modbus address	0	[OCA4]	(O C A 4)	R/W	15424
[Scan.Out5 address] (O C A 5) Scan Out 5 Modbus address	Eligible modbus address	0	[OCA5]	(O C A 5)	R/W	15425
[Scan.Out6 address] (O C A 6) Scan Out 6 Modbus address	Eligible modbus address	0	[OCA6]	(O C A 6)	R/W	15426
[Scan. IN1 address] (O M A 1) Scan In 1 Modbus address	Eligible modbus address	ETA	[OMA1]	(O M A 1)	R/W	15401
[Scan. IN2 address] (O M A 2) Scan In 2 Modbus address	Eligible modbus address	RFRD	[OMA2]	(O M A 2)	R/W	15402
[Scan. IN3 address] (O M A 3) Scan In 3 Modbus address	Eligible modbus address	0	[OMA3]	(O M A 3)	R/W	15403
[Scan. IN4 address] (O M A 4) Scan In 4 Modbus address	Eligible modbus address	0	[OMA4]	(O M A 4)	R/W	15404
[Scan. IN5 address] (O M A 5) Scan In 5 Modbus address	Eligible modbus address	0	[OMA5]	(O M A 5)	R/W	15405
[Scan. IN6 address] (O M A 6) Scan In 6 Modbus address	Eligible modbus address	0	[OMA6]	(O M A 6)	R/W	15406
[Internal link fault 1] (I L F 1) Option card 1 ILF faults	Eligible modbus address	0	[-]	(-)	R/W	7134
[Network fault] (C n F) Communication option interruption	Eligible modbus address	0	[-]	(-)	R/W	7132

- If control has been reserved: only the control word (**C P d**) written by the master with control will be accepted via I/O Scanning or via Modbus TCP messaging. Two TCP connections are reserved for this device. In this way, you avoid other TCP clients using all the available connections (8 maximum) and the control master therefore no longer being able to access the drive Modbus TCP server.

NOTE: Other parameters written from other IP addresses are accepted (for example, adjustments or writing a setpoint). When control has been reserved and another device attempts to write the control word (**C P d**):

- via I/O Scanning: The Modbus TCP connection for this client is immediately reinitialized.
 - via Modbus TCP messaging: Control is denied.
- If control has not been reserved (**[IP Master] = [0.0.0.0] (D) (D) (D) (D)**), control can come from any IP address.

Configuring I/O Scanning

The drive I/O Scanning service can be enabled or disabled in the **[COMMUNICATION] (C P -)** menu, **[COMMUNICATION CARD] (C b d -)** submenu via parameter **[Eth IO scan act] (I D S A)**.

It is not possible to modify the assignment of the I/O Scanning periodic variables using the display terminal (integrated or graphic). To configure I/O Scanning, use the standard Web server or the SoMove software.

FDR Settings

The parameters are accessible via **[CONFIGURATION]** (*C O N F -*), **[FULL]** (*F U L L -*), **[COMMUNICATION]** (*C O M -*) menu and **[COMMUNICATION CARD]** (*C b d -*) submenu.

The following table describes the parameters related to the “Fast device replacement settings”. More information about FDR settings can be found in “FDR Settings” on page 96

Parameter Description (HMI mnemonic)	Range or Listed Values	Default	Long Name	Short Name	Access	Parameter Number
[IP FDR] (<i>I P F</i>) (<i>I P F 1</i>)(<i>I P F 2</i>)(<i>I P F 3</i>) (<i>I P F 4</i>) These fields displays the served address of the FDR server	0 to 255 for each 4 fields	0.0.0.0	[0.0.0.0]	(<i>0</i>) (<i>0</i>) (<i>0</i>) (<i>0</i>)	R/W	64224 64225 64226 64227
[FDR validation] (<i>F d r U</i>) Enable FDR service	0: no 1: yes	yes	[No] [Yes]	(<i>n 0</i>) (<i>y e s</i>)	R/W	64228
[Ethernet local conf] (<i>L C F G</i>) Selection of local or server configuration	0: no 1: yes	no	[No] [Yes]	(<i>n 0</i>) (<i>y e s</i>)	R/W	64238
[FDR file error] (<i>F d r F</i>) Enable FDR detected fault management	0: no 1: yes	yes	[No] [Yes]	(<i>n 0</i>) (<i>y e s</i>)	R/W	64240
[FDR Action] (<i>F d r A</i>) IDLE: No command SAVE: save command REST: download command DEL: delete command	IDLE: No command SAVE: save command REST: download command DEL: delete command	IDLE	[IDLE] [SAVE] [REST] [DEL]	(<i>i d l e</i>) (<i>s a v e</i>) (<i>r e s t</i>) (<i>d e l</i>)	R/W	64229
[FDR autosave] (<i>F d r S</i>) Interval for periodic saving of the FDR service	0: no 1: yes	no	[No] [Yes]	(<i>n 0</i>) (<i>y e s</i>)	R/W	64230
[FDRt. autosave] (<i>F d r t</i>)	0 to 9999 minutes	0	[0]	(<i>0</i>)	R/W	64231
[FDR state] (<i>F d r E</i>) FDR service status	- IDLE: idle state - INIT: initialisation - CONF: configuration - RDY: ready - GET: download the current configuration - SET: save the current configuration - APP: Write the FDR server conf. to the drive - OPE: operational - UCFCG: not configured	IDLE	[IDLE] [INIT] [CONF] [RDY] [GET] [SET] [APP] [OPE] [UCFCG]	(<i>i d l e</i>) (<i>i n i t</i>) (<i>c o n f</i>) (<i>r d y</i>) (<i>g e t</i>) (<i>s e t</i>) (<i>a p p</i>) (<i>o p e</i>) (<i>u c f c g</i>)	RW	64232
[FDR Fault] (<i>F d r d</i>)	- 0: No detected fault - 2: the FDR configuration file is not compatible with the drive type - 3: Detected error reading the FDR configuration file on the server - 4: Detected error writing the configuration file to the server - 7: Time out for receipt of the FDR configuration file from the server - 9: duplicated IP address. - 12: the FDR configuration file is missing - 13: the FDR configuration file deployment on the drive has detected a fault (local detected error) - 14: the configuration file delete request has detected a fault on the FDR server	0	[0] [2] [3] [4] [7] [9] [12] [13] [14]	(<i>0</i>) (<i>2</i>) (<i>3</i>) (<i>4</i>) (<i>7</i>) (<i>9</i>) (<i>12</i>) (<i>13</i>) (<i>14</i>)	R	64233

NOTE: During the application of the configuration, the option use the File Transfer mechanism (FTP) and some system services. If all the transfers are well finished, the operational state is reached. If the configuration is ok: the operational state is reached, else if the configuration is not ok: the unconfigured state is reached (FDR error #14).

EtherNet/IP Settings

The parameters are accessible via **[CONFIGURATION]** (*C O N F -*), **[FULL]** (*F U L L -*), **[COMMUNICATION]** (*C O M -*) menu and **[COMMUNICATION CARD]** (*C b d -*) submenu.

These settings are only visible when the parameter **[Ethernet protocol]** (*E t H P*) is defined on **[EthernetIP]** (*E t I P*):

Parameter Description (HMI mnemonic)	Range or Listed Values	Default	Long Name	Short Name	Access	Parameter Number
[MAC @] (<i>M A C</i>) MAC address display	[00-80-F4-XX-XX-XX]	-	[00-80-F4-XX-XX-XX]	0080 F4--- XX XXXX	R	64267 64268 64269
[Rate setting] (<i>r d S</i>)	0: Autodetect 1: 10 Mbps Full 2: 10 Mbps Half 3: 100 Mbps Full 4: 100 Mbps Half	Auto	[Auto] [10M. full] [10M. half] [100M. full] [100M. half]	(R U t D) (I O F) (I O H) (I O O F) (I O O H)	R/W	64251
[Ethernet protocol] (<i>E t H P</i>)	0:Modbus TCP 1:EtherNet/IP	0	[Modbus TCP] [EthernetIP]	(M b t P) (E t I P)	R/W	64241
[IP mode] (<i>I P M</i>) Use this parameter to select the IP address assignment method	0: Man 1: BOOTP 2: DHCP	DHCP	[fixed] [BOOTP] [DHCP]	(M A N U) (b O O t) (d H C P)	R/W	64250
[IP card] (<i>I P C</i>) (I P C 1) (I P C 2) (I P C 3) (I P C 4) These fields are editable when IP mode is set to Fixed address	0 to 255 for each 4 fields	0.0.0.0	[0.0.0.0]	(D) (D) (D) (D)	R/W	64212 64213 64214 64215
[IP Gate] (<i>I P G</i>) (I P G 1) (I P G 2) (I P G 3) (I P G 4) These fields are editable when IP mode is set to Fixed address	0 to 255 for each 4 fields	-	[0.0.0.0]	(D) (D) (D) (D)	R/W	64220 64221 64222 64223
[Conf. Assembly] (<i>C I O 2</i>) Configured output assembly	20,21,100, 101	20	[20]	-	R	-
[SERVICES] (<i>E W E -</i>) Enable web services	0: No web services 1: Web server enabled	1	-	-	R/W	-
[Scan.Out1 address] (<i>O C A 1</i>)	Eligible modbus address	CMD	[OCA1]	(O C A 1)	R/W	15421
[Scan.Out2 address] (<i>O C A 2</i>)	Eligible modbus address	LFRD	[OCA2]	(O C A 2)	R/W	15422
[Scan.Out3 address] (<i>O C A 3</i>)	Eligible modbus address	0	[OCA3]	(O C A 3)	R/W	15423
[Scan.Out4 address] (<i>O C A 4</i>)	Eligible modbus address	0	[OCA4]	(O C A 4)	R/W	15424
[Scan.Out5 address] (<i>O C A 5</i>)	Eligible modbus address	0	[OCA5]	(O C A 5)	R/W	15425
[Scan.Out6 address] (<i>O C A 6</i>)	Eligible modbus address	0	[OCA6]	(O C A 6)	R/W	15426
[Scan. IN1 address] (<i>O M A 1</i>)	Eligible modbus address	ETA	[OMA1]	(O M A 1)	R/W	15401
[Scan. IN2 address] (<i>O M A 2</i>)	Eligible modbus address	RFRD	[OMA2]	(O M A 2)	R/W	15402
[Scan. IN3 address] (<i>O M A 3</i>)	Eligible modbus address	0	[OMA3]	(O M A 3)	R/W	15403
[Scan. IN4 address] (<i>O M A 4</i>)	Eligible modbus address	0	[OMA4]	(O M A 4)	R/W	15404
[Scan. IN5 address] (<i>O M A 5</i>)	Eligible modbus address	0	[OMA5]	(O M A 5)	R/W	15405
[Scan. IN6 address] (<i>O M A 6</i>)	Eligible modbus address	0	[OMA6]	(O M A 6)	R/W	15406
[Internal link fault 1] (<i>I L F 1</i>) Communication interruption between option card 1 and drive	Eligible modbus address	0	[-]	(-)	R/W	7134
[Network fault] (<i>C n F</i>) Communication option detected fault	Eligible modbus address	0	[-]	(-)	R/W	7132

Monitoring of Communication Channels

Command and Reference Channels

All the drive's command and reference parameters are managed on a channel-by-channel basis.

It is possible to identify the last value written for each channel and each command or reference parameter:

Parameter name	Parameter code			
	Taken into account by the drive	Modbus	CANopen	Communication card
Control word	(C Nd)	(C Nd 1)	(C Nd 2)	(C Nd 3)
Extended control word	(C N 1)	(C N 1 1)	(C N 1 2)	(C N 1 3)
Speed reference (rpm)	(L Fr d)	(L Fr d 1)	(L Fr d 2)	(L Fr d 3)
Frequency reference (0.1 Hz)	(L Fr)	(L Fr 1)	(L Fr 2)	(L Fr 3)
PI regulator reference	(P ISP)	(P Ir 1)	(P Ir 2)	(P Ir 3)
Analog multiplier reference	(PF r)	(PF r 1)	(PF r 2)	(PF r 3)

Network Monitoring Criteria

The network is monitored according to the protocol-specific criteria.

Protocol	Criteria	Related detected fault
Integrated Modbus port	Adjustable time-out for received requests destined for the drive.	[Modbus fault] (S L F)
Ethernet card	FDR detected fault IP address duplication detected fault Adjustable time-out for received control word (I/O scanning or messaging) Network overload	[EXTERNAL FAULT COM.] (E P F 2) [NETWORK FAULT] (C N F)

Monitoring of Communication Channels

Communication channels are monitored if they are involved in one of the following parameters:

- The control word ([Cmd value] (C Nd)) from the active command channel
- The control word containing the command switch (bit configured on [Cmd switching] (C C 5))
- The control word containing the switch for reference 1'1B (bit configured on [Ref 1B switching] (r C b))
- The control word containing the switch for reference 1'2 (bit configured on [Ref. 2 switching] (r F C))
- The frequency or speed reference ([HMI Frequency ref.] (L Fr) or LFRD: Nominal speed value) from the active reference channel
- Summing frequency or speed reference ([HMI Frequency ref.] (L Fr) or LFRD: Nominal speed value) 2 (assigned to [Summing ref. 2] (S R 2))
- Summing frequency or speed reference ([HMI Frequency ref.] (L Fr) or LFRD: Nominal speed value) 3 (assigned to [Summing ref. 3] (S R 3))
- Subtracting frequency or speed reference ([HMI Frequency ref.] (L Fr) or LFRD: Nominal speed value) 2 (assigned to [Subtract ref. 2] (d R 2))
- Subtracting frequency or speed reference ([HMI Frequency ref.] (L Fr) or LFRD: Nominal speed value) 3 (assigned to [Subtract ref. 3] (d R 3))
- The PID regulator reference (PISP)
- The PID regulator feedback ([AI Virtual 2] (A I U 2))
- The reference multiplication coefficient ([Multiplying coeff.] (PF r)) 2 (assigned to [Multiplier ref. 2] (P R 2))
- The reference multiplication coefficient ([Multiplying coeff.] (PF r)) 3 (assigned to [Multiplier ref. 3] (P R 3))

As soon as one of these parameters has been written once to a communication channel, it activates monitoring for that channel.

If a communication alarm is sent (in accordance with the protocol criteria) by a monitored port or network card, the drive will trigger a communication interruption.

The drive reacts according to the communication interruption configuration (detected fault, maintenance, fallback, etc.)

If a communication alarm occurs on a channel that is not being monitored, the drive will not trigger a communication interruption.

Enabling of Communication Channels

A communication channel is enabled once all the parameters involved have been written at least one time. The drive is only able to start if all channels involved in command and reference are enabled.

Example:

A drive in DSP402 profile is connected to an active communication channel.

It is mandatory to write at least one time the reference and the command in order to switch from “4-Switched on” to “5-Operation enabled” state

A communication channel is disabled:

- In the event of a communication alarm
- In “forced local” mode.

Note: On exiting “forced local” mode:

- The drive copies the run commands, the direction and the forced local reference to the active channel (maintained).
- Monitoring of the active command and reference channels resumes following a time delay **[Time-out forc. local] (F L D E)**.
- Drive control only takes effect once the drive has received the reference and the command from the active channel.

Configuration of the Drive Commands Settings

4

Overview

This chapter explains how to configure the drive for operation from communication network through 3 following examples:

- I/O Mode - a simple command Word (based on forward, reverse and reset binary commands).
- Combined Mode (with native profile CiA402) - Both reference and command word come from the communication network.
- Separate (with native profile CiA402) - Reference and command word come from separate sources: for example, the command word (in CiA402) comes from the communication network and the reference word from the HMI.

What's in this Chapter?

This chapter contains the following topics:

Topic	Page
Configuration of the Drive for Operation in I/O Profile	33
Configuration of the Drive for Operation With CiA402 Profile in Combined Mode	34
Configuration of the Drive for Operation With CiA402 Profile in Separate Mode	34

Configuration of the Drive for Operation in I/O Profile

To illustrate the I/O Profile, we will describe a simple example, which can be of course extended with additional features. The Command word is made of Run forward (bit 0 of *CNd*), run reverse (bit 1 of *CNd*), and a detected fault reset (bit 7 of *CNd*).

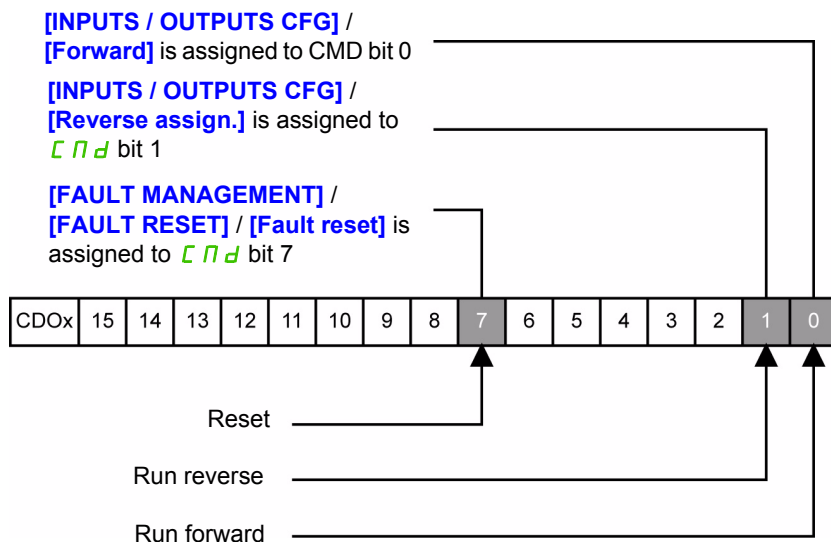

The settings will be the following:

[Ref.1 channel] (<i>F r l</i>)	[HMI] (<i>H n l</i>) (for example)
[RV Inhibition] (<i>r l n</i>)	Default
[Stop Key priority] (<i>P S t</i>)	Default
[Profile] (<i>C H C F</i>)	[I/O profile] (<i>l O</i>)
[Cmd switching] (<i>C C S</i>)	Default
[Cmd channel 1] (<i>C d l</i>)	[Com. card] (<i>n E t</i>)

The bits of the command word must now be configured.

In the **[INPUTS / OUTPUTS CFG]** Menu, configure:

[Forward] (<i>F r d</i>)	[Cd00] (<i>C d D D</i>)
[Reverse assign.] (<i>r r S</i>)	[Cd01] (<i>C d D l</i>)

In the **[FAULT MANAGEMENT]** menu, **[FAULT RESET]** submenu, configure:

[Fault reset] (<i>r S F</i>)	[Cd07] (<i>C d D 7</i>)
---------------------------------------	----------------------------------

Configuration of the Drive for Operation With CiA402 Profile in Combined Mode

This chapter describes how to configure the settings of the drive if it is controlled in CiA402 Mode. The example focuses on the Not separate mode (Combined). Additional modes such as the separate Mode are detailed in the ATV32 Programming manual.

In the Command Menu **[Command]** (C E L -):

- **[Ref.1 channel]** (F r I): is set according to the communication source you can choose in the following table:

Origin of the control	Ref1 Channel setting
EtherNet/IP - Modbus TCP	[Com. card] (n E E)

- **[Profile]** (C H C F): defines if the drive operates in combined mode (reference and command from the same channel).

Configuration of the Drive for Operation With CiA402 Profile in Separate Mode

Alternate combinations are possible, see the ATV32 programming manual for the list of possible settings.

Example:

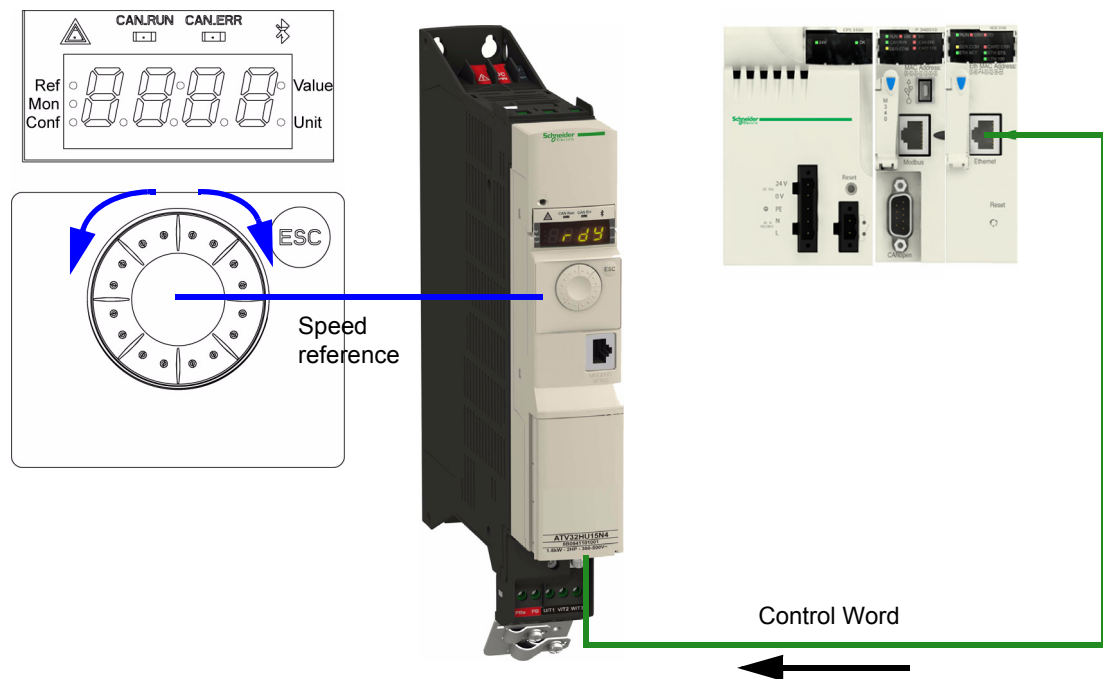

The drive is controlled from the communication (EtherNet) but the reference is adjusted on the local HMI. The control word comes from the controller and is written according to CiA402 profile.

The settings will be as follows:

[Ref.1 channel] (F r I)	[AI virtual 1] (R I U I)
[RV Inhibition] (r I n)	Default
[Stop Key priority] (P S t)	Default
[Profile] (C H C F)	[Separate] (S E P)
[Cmd switching] (C C S)	Default
[Cmd channel 1] (C d I)	[Com. card] (n E E)

Network Layer Supported Functions/Protocols

5

ARP, ICMP and IP Protocol

ARP Protocol

The ARP (Address Resolution Protocol) is a protocol used by the IP (Internet Protocol) network layer protocol to map IP network addresses to hardware addresses (MAC address). The protocol operates below the network layer as a part of the OSI link layer, and is used when IP is used over Ethernet.

A host, wishing to obtain a physical address, broadcasts an ARP request onto the TCP/IP network. The host on the network, that has the IP address in the request, then replies with its physical HA (Hardware Address).

There are four types of ARP messages which may be sent by the ARP protocol. They are identified by two values in the "operation" field of an ARP message. The types of message are: ARP request; ARP reply.

The following table describes the format of an ARP message:

0	8	15	16	31
Hardware Type		Protocol Type		
HLEN (Hardware address Length)	PLEN (Protocol address Length)	Operation		
Sender HA (bytes 0-3)				
Sender HA (bytes 4-5)		Sender IP (bytes 0-1)		
Sender IP (bytes 2-3)		Target HA (bytes 0-1)		
Target HA (bytes 2-5)				
Target IP (bytes 0-3)				

ARP frames are described as follows:

- ARP Request: it allows to get the hardware (MAC) Address of a remote device.
- Gratuitous ARP: it allows to announce the use of an IP and Hardware Addresses.
- ARP Probe: it allows questioning the network to know if an IP Address is already used without updating the ARP table of the other hosts on the network.

The following table describes the ARP frames:

	ARP Request	Gratuitous ARP / Response	ARP Probe
Sender IP Address	Local IP Address	Local IP Address	Zero
Sender Hardware Address	Local MAC Address	Local MAC Address	Local MAC Address
Target IP Address	Non-zero (!= Sender IP Address)	Local IP Address (= Sender IP Address)	IP Address to probe
Target Hardware Address	Zero	Non significant	Zero

ICMP Protocol

The Option board manages the ICMP protocol.

- ICMP client: not supported
- ICMP server: the managed requests are the following:

Type	Description	Type	Description
0	Echo reply (ping)	11	Time exceeded
3	Destination unreachable	12	Parameter problem
4	Source quench	13	Timestamp request
5	Redirect	14	Timestamp reply
6	Alternate Host Address	15	Information request
8	Echo request (ping)	16	Information reply
9	Router advertisement	17	Address mask request
10	Router solicitation	18	Address mask reply

IP Protocol

The OB (Option Board) implements the IP protocol V4.

SNMP Services

The VW3 A3 316 accepts the Community Name "Schneider" for Reading/Writing and the Community Name "Public" for Reading only.

MIB

Objects	Description	Access	Default Value
SysDescr	Text description of the product	RO	Schneider Electric Altivar Fast Ethernet TCP/IP Module
SysObjectID	Points in the private MIB on the product reference	RO	1.3.6.1.4.1.3833.1.7.255.6
SysUpTime	Time elapsed since the last power up	RO	Managed by the option
SysContact	Information allowing to contact the node manager	R/W	" "
SysName	Node administrative name	R/W	"ATV" or FDR device name if configured
SysLocation	Physical location of the product	R/W	" "
SysService	Indicates the service type offered by the product.	RO	72

Transport Layer Protocols

6

TCP and UDP Protocol

Connections

The VW3 A3 616 supports maximum 8 concurrent TCP connections.

The VW3 A3 616 device, according to EtherNet/IP specifications, supports:

- 3 concurrent encapsulation sessions,
- 6 concurrent transport class 3 explicit messaging connections,
- more than 1 transport class 3 connection per encapsulation session.

BOOTP and DHCP Protocol

The VW3 A3 616 can use BOOTP and DHCP protocols.

BOOTP & DHCP protocol frames

The following table describes the DHCP frame format:

OP (1byte)	HTYPE (1 byte)	HLEN (1 byte)	HOPS (1 byte)
XID (4 bytes)			
SECS (2 bytes)		FLAGS (2 bytes)	
CIADDR (4 bytes)			
YIADDR (4 bytes)			
SIADDR (4 bytes)			
GIADDR (4 bytes)			
CHADDR (16 bytes)			
SNAME (64 bytes)			
FILE (128 bytes)			
OPTIONS (312 bytes)			

The BOOTP frame is the same: only the VW3 A3 616 OP field is different.

DHCP frame fields are described as follows:

Field	Description
op	Message type DHCP Request / DHCP Reply
htype	Address hardware type
hlen	Hardware address length
hops	Used by relay agent
xid	Transaction identifier, random number chosen by the client allowing to associate the request and the response
secs	Time in seconds since the beginning of the transaction
flags	First bit used for the Broadcast reply flag
ciaddr	Client IP address, only used if the client can respond to ARP request
yiaddr	Client IP address, "your" IP address proposed by the server
siaddr	IP address of the server
giaddr	Gateway IP address, used when a relay agent needs to be crossed
sname	Server Name
file	Location of boot file
options	Optional parameters with DHCP extensions

DHCP messages

The DHCP protocol uses 8 different types of message during the IP assigning process.

The following table describes the 8 messages:

Message	Description
DISCOVER	The client tries to discover the DHCP server using a broadcast
OFFER	The server proposes a configuration
REQUEST	The client chooses a DHCP server and declines other offers
ACK	The chosen server assigns the IP configuration
NAK	The server rejects the client request
DECLINE	The client declines the assigned IP configuration
RELEASE	The client releases its IP address before the end of the lease
INFORM	The client asks for network information (it already has an IP address)

Operating mode

The choice between DHCP, BOOTP and manual configuration is made through one parameter:

- Manual mode: the VW3 A3 616 uses the address stored in parameter.
- BOOTP: card receives the addresses from BOOTP server.
- DHCP: if the Altivar Device name [XXX] is a valid name, the VW3 A3 616 receives the addresses from the DHCP server.

Modbus TCP Features



7

What's in this Chapter?

This chapter contains the following topics:

Topic	Page
Modbus TCP Frames	40
ATV32 and VW3 A3 616: Modbus Servers	40
Supported Modbus Functions	41
Application Profile with Modbus TCP	42
Configuring Communication Detected Fault Management	42
Configuring Monitor Parameters	44

Modbus TCP Frames

TCP Telegrams

Modbus TCP telegrams are not only Modbus standard requests and responses encapsulated in TCP frames.

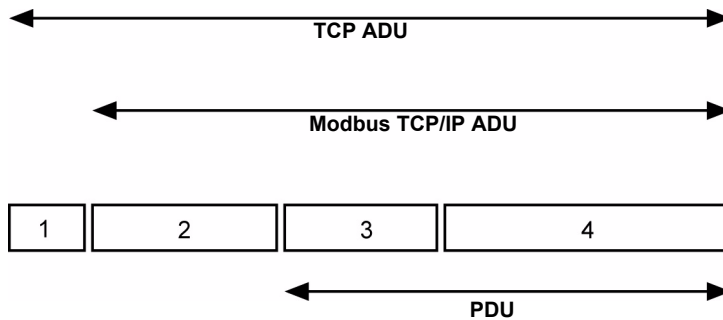

- (1) TCP header
- (2) MBPA: Modbus Application Protocol Header
- (3) ADU: Application data Unit
- (4) PDU: Protocol data Unit (The Modbus Message itself)

MBAP Header Structure

Fields	Length	Description	Client	Server
Transaction Identifier	2 Bytes	Identification of a Modbus request / response transaction	Initialized by the client	Recopied by the server from the received request
Protocol Identifier	2 Bytes	0= Modbus protocol	Initialized by the client	Recopied by the server from the received request
Length	2 Bytes	Number of following bytes	Initialized by the client (request)	Initialized by the server (response)
Unit Identifier	1 Byte	Identification of a remote slave connected on a serial line or on other buses	Initialized by the client	Recopied by the server from the received request

ATV32 and VW3 A3 616: Modbus Servers

Unit ID	Modbus TCP server	Accessible parameters
0	Variable speed drive	See ATV32 Communication parameters
251	Ethernet card	See ATV32 Communication parameters
255	I/O scanner	See "I/O Scanner Setting" on page 42

Supported Modbus Functions

Modbus Services

The Modbus TCP option supports the following Modbus services:

Function Name	Code	Description	Remarks
Read holding registers	03 16#03	Read N output words	Max PDU length: 63 words
Write one output word	06 16#06	Write one output word	
Write multiple registers	16 16#10	Write N output word	Max PDU length: 63 words
Read/write Multiple registers	23 16#17	Read/write multiple registers	Max PDU length: 20 words (W), 20 words ®
(Sub-function) Read device Identification	43/14 16#2B 16#0E	Encapsulated interface transport / Read device identification	See the table below

NOTE: I/O scanner service is based on the function 23. To avoid unpredictable behavior, priority should be given to this function with regards to the functions 6 and 16.

Identification

Id	Value	Comment
16#00	"Schneider electric"	-
16#01	--	-
16#02	"0201"	-
16#04	"ALTIVAR 32"	Drive family
16#05	"ATV-XXXXX"	Drive commercial reference
16#06	"North elevator"	Device Name
16#07	--	-
16#08	2#00000000_00001011	-
16#09	--	-
16#0A	--	-
16#0B	--	-
16#0C	--	-

I/O Scanning Service

The I/O scanning service is used to exchange periodic I/O data between:

- A controller or PLC (I/O scanner).
- Devices (I/O scanning servers).

This service is activated with **[Eth IO scan act]** (*IO5A*) parameter ((*IO5A*) = *OFF* by default).

This exchange is usually performed by implicit services, thus avoiding the need to program the controller (PLC).

The I/O scanner periodically generates the Read/Write Multiple Registers (23 = 16#17) request. The I/O scanning service operates if it has been enabled in the PLC and the drive. The drive parameters assigned to I/O scanning have been selected by default. This assignment can be modified by configuration.

The drive I/O scanning service can also be configured by the Ethernet card Modbus server.

When the I/O scanning service has been enabled in the Altivar 32 drive:

- A TCP connection is assigned to it.
- The parameters assigned in the periodic variables are exchanged cyclically between the Ethernet card and the drive.
- The parameters assigned to the periodic output variables are reserved for I/O scanning. They cannot be written by other Modbus services, even if the I/O scanner is not sending its periodic output variables.

I/O Scanner Setting

The communication scanner is accessible via the following menus: **[COMMUNICATION]** (*C O N -*) and **[COMMUNICATION CARD]** (*c b d*) submenus.

The 6 output variables and the 6 input variables are assigned by means of parameters (*O C A 1*) to (*O C A 6*) and (*O N A 1*) to (*O N A 6*). An (*O C A x*) or (*O N A x*) parameter with a value of zero is not linked to a parameter in the drive.

These 6 parameters are described in the table below.

(*O C A x*) or (*O N A x*) defines the addresses.

[Scan.Out1 address]	(<i>O C A 1</i>)	(<i>C N d</i>)
[Scan.Out2 address]	(<i>O C A 2</i>)	(<i>L F r d</i>)
[Scan.Out3 address]	(<i>O C A 3</i>)	0
[Scan.Out4 address]	(<i>O C A 4</i>)	0
[Scan.Out5 address]	(<i>O C A 5</i>)	0
[Scan.Out6 address]	(<i>O C A 6</i>)	0
[Scan.IN1 address]	(<i>O N A 1</i>)	(<i>E E A</i>)
[Scan.IN2 address]	(<i>O N A 2</i>)	(<i>r F r d</i>)
[Scan.IN3 address]	(<i>O N A 3</i>)	0
[Scan.IN4 address]	(<i>O N A 4</i>)	0
[Scan.IN5 address]	(<i>O N A 5</i>)	0
[Scan.IN6 address]	(<i>O N A 6</i>)	0

Application Profile with Modbus TCP

The profiles managed with the ATV32 when it is controlled through Modbus TCP are:

- native profile (CiA402 - IEC 61800-7),
- I/O profile.

Please refer to “CiA@402 - IEC61800-7 Functional Profile” on page 72.

Configuring Communication Detected Fault Management

The response of the drive in the event of an Ethernet communication detected fault can be configured.

It can be configured via the graphic display terminal or the integrated display terminal from the **[FAULT MANAGEMENT]** (*F L E -*) menu, **[COM. FAULT MANAGEMENT]** (*C L L -*) submenu, via the **[Network fault mgt]** (*C L L*) parameter.

RDY	NET	+0.00Hz	0A
COM. FAULT MANAGEMENT			<input type="checkbox"/>
Network fault mgt	:	Freewheel	
CANopen fault mgt	:	Freewheel	
Modbus fault mgt	:	Freewheel	
Code		Quick	<input type="checkbox"/>

The values of the **[Network fault mgt]** (CLL) parameter, which trigger a drive detected fault **[Com. network]** (CNF), are:

Value	Meaning
[Freewheel] (YES)	Freewheel stop (factory setting)
[Ramp stop] (RPP)	Stop on ramp
[Fast stop] (FSE)	Fast stop
[DC injection] (dLI)	DC injection stop

The values of the **[Network fault mgt]** (CLL) parameter, which do not trigger a drive detected fault, are:

Value	Meaning
[Ignore] (nD)	Detected fault ignored
[Per STT] (SESE)	Stop according to configuration of [Type of stop] (SESE)
[fallback spd] (LFF)	Change to fallback speed, maintained as long as the detected fault persists and the run command has not been removed
[Spd maint.] (RLS)	The drive maintains the speed at the time the detected fault occurred, as long as the detected fault persists and the run command has not been removed

The fallback speed can be configured in the **[FAULT MANAGEMENT]** (FLF-) menu using the **[Fallback speed]** (LFF) parameter.

▲ WARNING
LOSS OF CONTROL
If [Network fault mgt] (CLL) = [Ignore] (nD), communication control will be inhibited. For safety reasons, inhibition of communication fault should only be used for adjustment or special applications purpose.
Failure to follow these instructions can result in death, serious injury, or equipment damage.

CnF and ILF Detected Faults

The following table lists the time-out parameters:

Parameter	Description	Possible Values	Terminal Display
[Com. network] (CNF) (written to the device)	This detected fault is used to indicate that a network detected fault has occurred. When the detected fault occurs, the option position the CNF parameter to the value corresponding to the detected fault. When the detected fault has disappeared, the option writes the CNF parameter to 0	1: Modbus TCP timeout 10: Network overload 11: Loss of carrier 14: Ethernet/IP Scanner timeout 15: Ethernet/IP Idle Poll 16: Ethernet/IP forced EIP trip 17: Application I/O configuration detected error	[1] (1) [10] (10) [11] (11) [14] (14) [15] (15) [16] (16) [17] (17)
[int. com.link] (ILF)	This detected fault indicates a critical detected error and can be cleared. It needs a Power Off / Power On to remove the detected fault	13: FDR uncoverable detected error 18: EEPROM detected error 21: Internal detected error	[13] (13) [18] (18) [21] (21)
[External fault com.] (EPFZ)		8: No valid IP 9: Duplicate IP address 12: FRD unconfigured detected error 13: FDR uncoverable detected error 20: invalid drive config when activating ODVA profile.	[8] (8) [9] (9) [12] (12) [13] (13) [20] (20)

Configuring Monitor Parameters

It is possible to select up to 4 parameters to display their values in the [1.2 MONITORING] menu on the graphic display terminal (to be ordered separately - reference VW3 A1 101).

The selection is made via the [3.3 MONITORING CONFIG.] menu, [CONFIG. COMM. MAP] submenu.

Each parameter, in the range [Address 1 select] ... [Address 4 select], can be used to select the parameter logic address. An address at zero is used to disable the function.

Example

In the example given here, the monitored words are:

- Parameter 1 = Motor current (L C r): logic address 3204, signed decimal format.
- Parameter 2 = Motor torque (D E r): logic address 3205, signed decimal format.
- Parameter 3 = Last detected fault occurred (L F E): logic address 7121, hexadecimal format.
- Disabled parameter: Address W0; default format: Hexadecimal format

RDY	NET	+0.00Hz	0A
CONFIG. COMM. MAP.			
Address 1 select	:		3204
Format address 1	:		Signed
Address 2 select	:		3205
Format address 2	:		Signed
Address 3 select	:		7121
Code		Quick	<input checked="" type="checkbox"/>

One of the three display formats below can be assigned to each monitored word:

Format	Range	Terminal display
Hexadecimal	0000 ... FFFF	[Hex] (HEX)
Signed decimal	-32 767 ... 32 767	[Signed] (S I G)
Unsigned decimal	0 ... 65 535	[Unsigned] (n S G)

NOTE: If a monitored parameter:

- Has been assigned to an unknown address (example: 3200).
- Has been assigned to a protected parameter.
- Has not been assigned.

the value displayed in the [COMMUNICATION MAP] screen will be: "••••" (see "CnF and ILF Detected Faults" on page 43).

Controlling an ATV32 From Modbus TCP (M340)



8

What's in this Chapter?

This chapter contains the following topics:

Topic	Page
Description of the Configuration	46
Configuration of the Ethernet Module (NOE 100 or NOE 110)	48
Monitor and Control the Exchanges	51
Modbus Messaging	52

Description of the Configuration

The configuration is made of an ATV32 and a M340 with a NOE110 (or NOE100) Ethernet module.

The devices are configured with the (fixed) following IP addresses as follows:

IP: 10.0.0.11

IP: 10.0.0.10



The ATV32 will be controlled through the option communication scanner by means of the I/O scanning service.

It is important to notice that the implicit exchanges are based on the VW3 A3 616 internal communication scanner and not on the ATV32 internal scanner. The first one is reachable by using the unit ID 255, while the second one is reachable with the Unit ID 0:

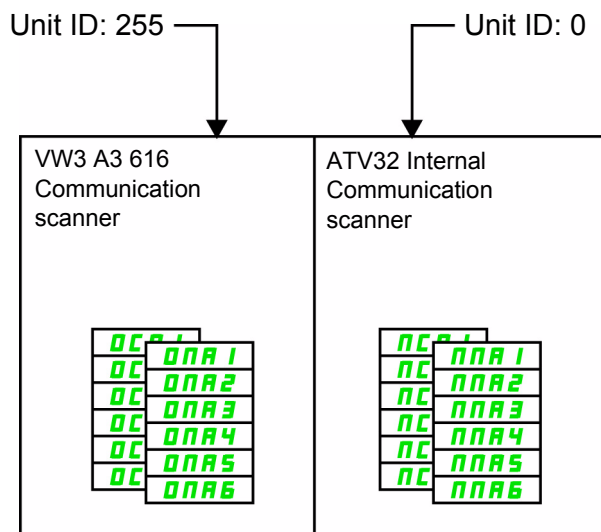

The option Com scanner parameters start with *(DCR x)* and *(DNR x)* and are part of the communication card submenu (instead of *(NCR x)*, *(NNR x)*) for the drive which are directly located in the Communication main menu). The usage of the *(NCR x)*, *(NNR x)* with (via Unit ID 0) is not recommended.

Configuration of the VW3 A3 616 Communication Card

Conf > Full > Communication > Communication card

ETHM = MBTP		Defines the protocol used: Modbus TCP
IPM = MANU		IP address is defined locally
IP card = 10.0.0.11		-
IP Mask 255.0.0.0		-
IP Master = 10.0.0.10		Defines the address of the I/O scanner client (M340 Ethernet module)
OCA1	8501 > CMD	In the example we will use the default parameters + an additional parameter for monitoring
OCA2	8602 > LFRD	
OCA3	-	
OCA4	-	
OCA5	-	
OCA6	-	
OMA1	3201 > ETA	
OMA2	8604 > RFRD	
OMA3	3207 > ULN	
OMA4	-	
OMA5	-	
OMA6	-	

Configuration of the Command

In the Command Menu **[Command]** (C E L):

- **[Ref1 Channel]** (F r I): is set according to the communication source you can choose in the following table:

Origin of the control	Ref1 Channel setting
Modbus TCP	[Com. card] (n E E)

- **[Rv Inhibition]** (r I n): default.
- **[Stop Key priority]** (P S E): default.
- **[Profile]** (C H C F): defines if the drives operates in combined mode (reference and command from the same channel)

For the current example, **[Profile]** (C H C F) will be adjusted to **[Combined]** (S I n) as reference and control are originated from the communication network:

Profile	Ref1 Channel setting
CiA402	[Combined] (S I n)
Separate	[Separate] (S E P)
I/O Profile	[I/O Mode] (I D)

Configuration of the Ethernet Module (NOE 100 or NOE 110)

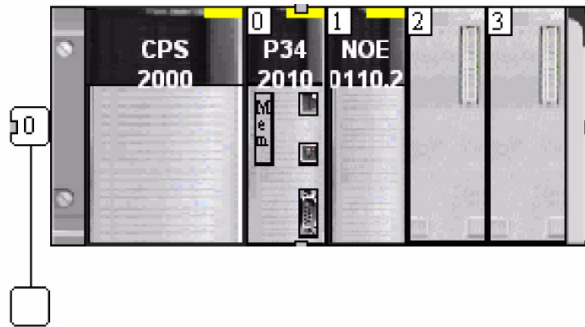

Create a new logical network in the section:



Configuration of the IP Settings

Model Family: NOE 0100.2, NOE 0110.2

Module Address: Rack: 0, Module: 1, Channel: 0

Module Utilities: YES (ID Scanning), NO (Global Data), NO (Address Server), NO (NTP)

Module IP Address: IP Address: 10 . 0 . 0 . 10, Subnetwork Mask: 255 . 255 . 255 . 0, Gateway Address: 0 . 0 . 0 . 0

IP Configuration | Messaging | IO Scanning | Global Data | SNMP | Address Server | NTP | Bandwidth

IP address configuration:

Configured

IP address: 10 . 0 . 0 . 10

Subnetwork mask: 255 . 0 . 0 . 0

Gateway address: 0 . 0 . 0 . 0

From a server

Device Name: _____

Ethernet configuration:

Ethernet II 802.3

Enable Messaging With the ATV32

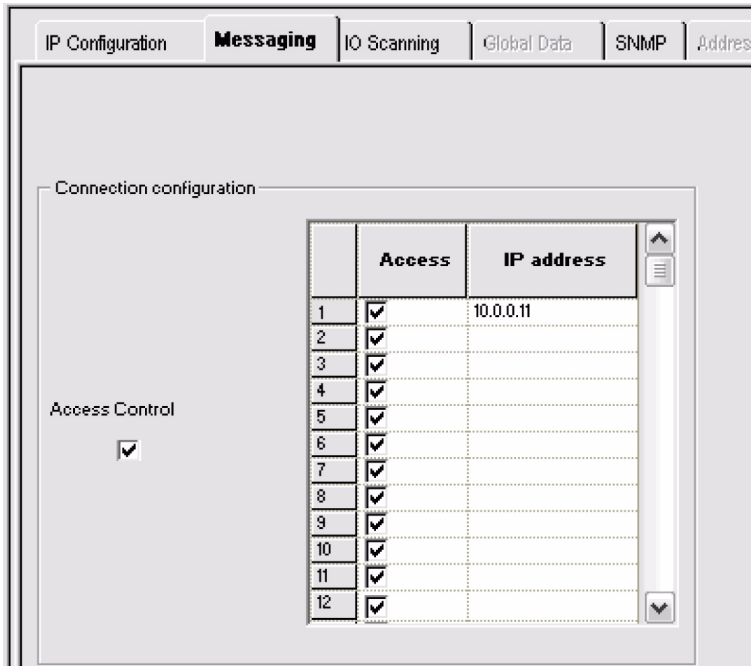

Configure I/O Scanning With the ATV32

Master %MW zones
 Read Ref. From 100 to 106 Write Ref. From 200 to 206

	IP address	Unit ID	Health Timeout (ms)	Repetitive rate (ms)	RD Master Object	RD Slave Index	RD length	Last va (Input)
1	10.0.0.11	255	1500	10	%MW100	0	7	Set to 0
2								
3								
4								
5								
6								
7								
8								
9								
10								
11								
12								

ATV IP address
 Unit ID: 255 (option card)
 Time out for monitoring
 Period: here 10 ms
 1st address of the %MW for the read data (ATV > M340)
 1st address of the %MW for the read data (ATV > M340)
 Length: 7

NOTE: The length of the communication is 6 words, but the first word of the I/O scanning service is reserved. In practice, (DNR I) will be linked to %MW101 and (DCR I) will be linked to %MW201.

1st address of the %MW for the written data (M340 > ATV) is shown below:

Unit ID	Health Timeout (ms)	Repetitive rate (ms)	RD Master Object	RD Slave Index	RD length	Last value (Input)	VR Master Object	VR Slave Index	VR length	Description
255	1500	10	%Mw100	0	7	Set to 0	%Mw200	0	7	

Default values if I/O scanning is stopped or detect a fault.

1st address of the %MW for the written data (M340 > ATV)

1st address of the %MW for the read data (M340 > ATV)

Length: 7

NOTE: The length of the communication is 6 words, but the first word of the I/O scanning service is reserved. In practice, (O P R I) will be linked %MW101 and (O C R I) will be linked to %MW201.

Start and Check the Exchanges

Once the project is

built, it can be downloaded to the PLC and then launched. The exchanges (implicit) should start immediately:

Name	Value	Type	Comment
%Mw101	16#0233	INT	
%Mw102	0	INT	
%Mw103	2312	INT	
%Mw104	16#0000	INT	
%Mw105	16#0000	INT	
%Mw106	0	INT	
%Mw201	16#0007	INT	
%Mw202	-641	INT	
%Mw203	0	INT	
%Mw204	0	INT	
%Mw205	0	INT	
%Mw206	0	INT	

Monitor and Control the Exchanges

The communication can be monitored with several I/O objects.

In the example below, the I/O objects have been prefixed EthStatus.

You can check EthStatus.MOD_ERROR (will be equal to 1 if one or more exchanges are unsuccessful).

I/O Scanning

The array %IW0.1.0.1:4 displays the status of the overall active I/O scanning Client/server. This table is graphically animated in the debug view of the Ethernet module:

I/O Scanning

- Not configured 16
- Scanned 32
- Unscanned 48
- Faulty or absent 64

Name	Value	Type	Comment
EthStatus		T_GEN_MOD	
MOD_ERROR	0	BOOL	Module error
EXCH_STS	0	INT	Exchange status
STS_IN_PROGR	0	BOOL	Status parameter read in progress
EXCH_RPT	0	INT	Channel report
STS_ERR	0	BOOL	Error while reading module status
MOD_FLT	0	INT	Module faults
MOD_FAIL	0	BOOL	Internal fault: Module failure
CH_FLT	0	BOOL	Faulty channel(s)
BLK	0	BOOL	External fault: Terminal block
CONF_FLT	0	BOOL	Hardware or software configuration fault
NO_MOD	0	BOOL	Module absent or powered-down
EXT_MOD_FLT	0	BOOL	FIPIO extension module fault
MOD_FAIL_EXT	0	BOOL	Internal fault: Module failure (only FIPIO extension)
CH_FLT_EXT	0	BOOL	Faulty channel(s) (only FIPIO extension)
BLK_EXT	0	BOOL	External fault: Terminal block (only FIPIO extension)
CONF_FLT_EXT	0	BOOL	Hardware or software configuration fault (only FIPIO extension)
NO_MOD_EXT	0	BOOL	Module absent or powered-down (only FIPIO extension)
%IW0.1.0.0	2#1111_1111_1111_1100	INT	
%IW0.1.0.1	2#0000_0000_0000_0001	INT	
%QW0.1.0.0	0	BOOL	

The exchanges can be stopped by setting to 1 the pending bit in the array %QW0.1.0.0 (in the example).

Modbus Messaging

Access to the drive parameters is also available by means of the Modbus read / write functions. With the M340, this feature is achieved with the functions READ_VAR, WRITE_VAR.

Example with READ_VAR:

```
if not ReadVarbusy then
  READ_VAR( ADDM ('0.1.0{10.0.0.11}0'), '%MW' ,3603,2, ReadvarMGT, %MW124:4);
END_If;
```

READ_VAR address value:

3603	logic address of the 1st read word in the ATV32
2	Numbers of %MW
ReadvarMGT	1st word destination address
%MW124:4	Read_Var request status array
Readvarbusy	bit member of the array %MW124:4

The path to the device is obtained by the ADDM function with the following syntax:

0.1.0	Ethernet module
{10.0.0.11}	The IP address of the module
0: UnitID	Drive Unit ID (see "Modbus TCP Features" on page 39 for more details)

EtherNet/IP Features



9

What's in this Chapter?

This chapter contains the following topics:

Topic	Page
VW3 A3 616 and EtherNet/IP Overview	54
Cyclical Exchanges (Implicit Exchanges)	55
Messaging (Explicit Exchanges)	59
Detected Fault Management	60

VW3 A3 616 and EtherNet/IP Overview

EtherNet/IP Communication Card Features Overview

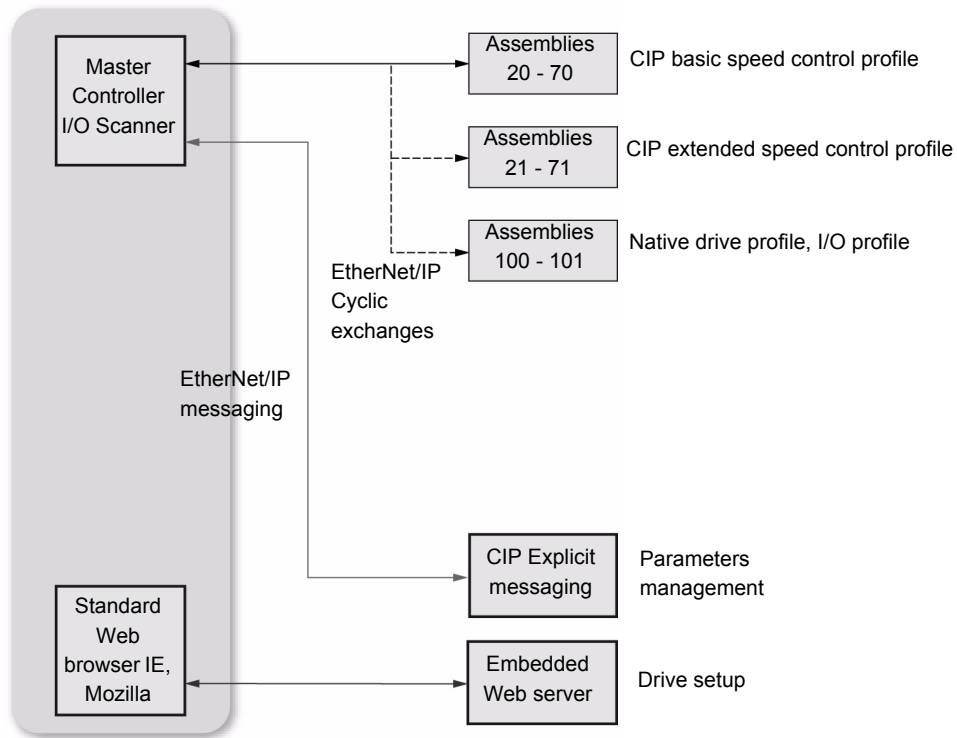

The Altivar 32, equipped with the VW3 A3 616, is compliant with the ODVA drive profile. It supports the 3 following profiles:

- CIP basic speed control
- CIP extended speed control
- ATV32 native profile (IEC 61800-7 CiA402) and I/O profile only for assembly 100 and 101.

In addition to these cyclic exchanges, the VW3 A3 616 also supports explicit messaging.

Cyclical Exchanges (Implicit Exchanges)

Overview

This part gives a description of the 3 assembly sets and how to configure them.

Principle of Control configuration

By the configuration of the control, it is possible to decide from what channel the drive receives its commands and setpoint, either permanently or depending on a switching command. Numerous configurations are possible. For more information, refer to the Programming manual and Communication parameters manual. The following configurations are some of the available possibilities.

The selection of the assembly set is made with the EtherNet/IP communication adapter.

Control With Communication Scanner

If the default assemblies (100, 101) are selected, the Altivar 32 will be controlled according to its native profile CiA402.-IEC-61800-7 (See "CiA402 - IEC61800-7 Functional Profile" on page 72). By configuring the communication scanner, it is possible to assign any relevant parameter of the drive to the 6 input and 6 output variables of the assemblies.

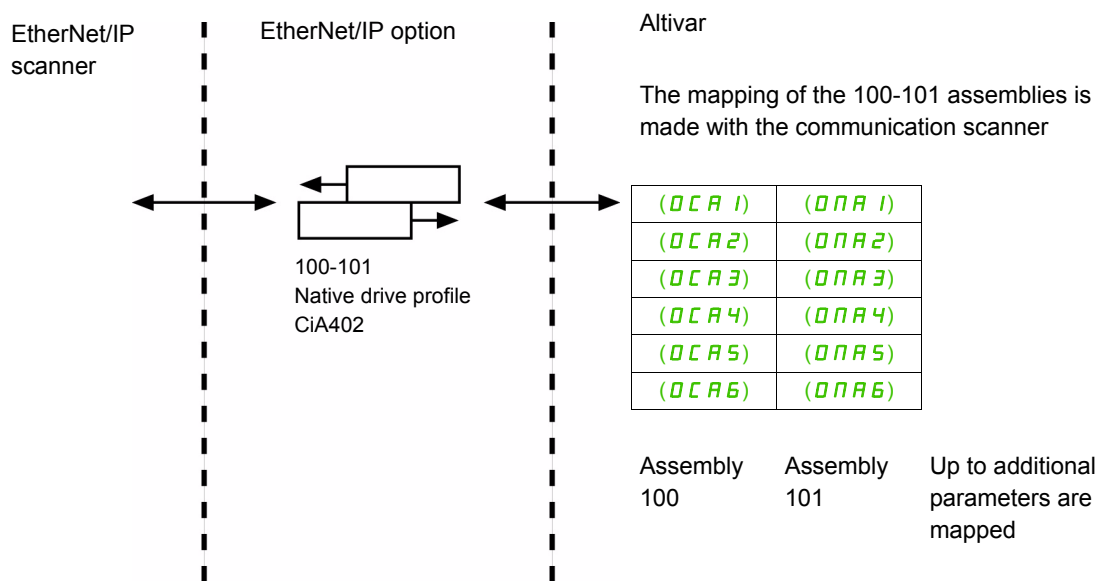

This configuration can be made with:

- HMI
- Keypad
- SoMove
- Webserver

The size of the assembly (100, 101) is fixed and is equal to 6 words.

The mapping of the other parameters is made with the communication scanner.

The configuration of the addresses defined with (DCAx) and (DPAx) can be made with the graphic keypad:

- For assembly 100: [COMMUNICATION] (C D P -) menu, [COMMUNICATION CARD] (C b d -) submenu.
- For assembly 101: [COMMUNICATION] (C D P -) menu, [COMMUNICATION CARD] (C b d -) submenu.

See menu [1.2 MONITORING] (P D n -) > COMMUNICATION MAP to monitor the communication scanner.

Assembly Set Selection With RS Logix - From Controller Side

Example of selection of the assemblies 100, 101 in the EtherNet/IP adapter configuration dialog box.

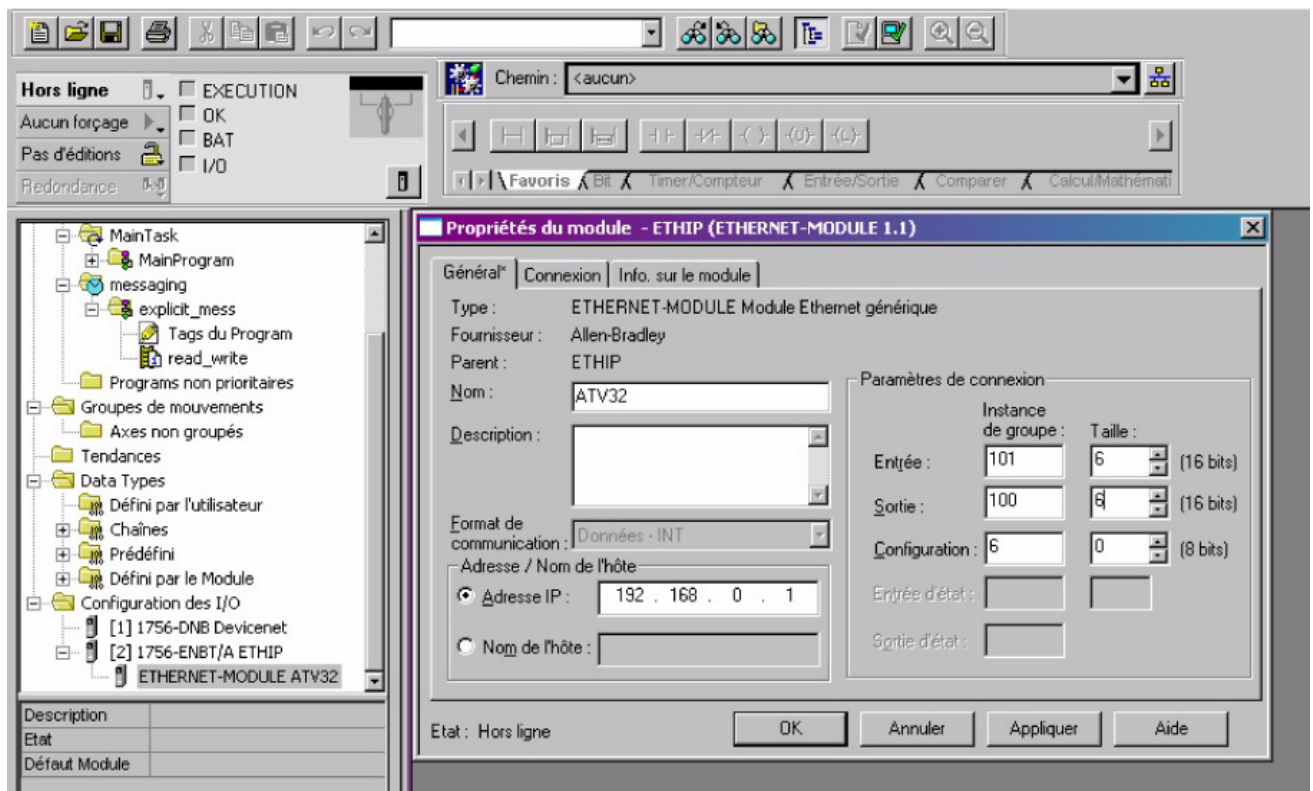

Control According to ODVA AC Drive Profile

The ODVA AC drive profile is activated when one of the following assemblies is selected:

- 20: Basic speed control output, size 2 words / 8 bytes
- 21: Extended speed control output, size 2 words / 8 bytes
- 70: Basic speed control input, size 2 words / 8 bytes
- 71: Extended speed control input, size 2 words / 8 bytes

The EtherNet/IP card translates the commands, behavior and monitoring information from of ODVA profile (on the network) to the CiA402 profile (in the drive).

CIP Basic Speed Control (Assemblies 20 and 70)

- Assembly 20: CIP basic speed control output

The following table describes the assembly mapping:

Word Number	Definition
0	CIP basic command word
1	Speed setpoint (rpm)

The following table describes the CIP basic command word:

Bit 7	Bit 6	Bit 5	Bit 4	Bit 3	Bit 2	Bit 1	Bit 0
Not used	Not used	Not used	Not used	Not used	Fault reset ⁽¹⁾ 0= No command 1= Fault reset	Not used	Run forward ⁽²⁾ 0= Stop 1= Run

(1) Active on rising edge

(2) Active on level

Bit 15	Bit 14	Bit 13	Bit 12	Bit 11	Bit 10	Bit 9	Bit 8
Not used	Not used	Not used	Not used	Not used	Not used	Not used	Not used

- Assembly 70: CIP basic speed control input

The following table describes the assembly mapping:

Word Number	Definition
0	CIP basic status word
1	Actual speed (rpm)

The following table describes the CIP basic status word:

Bit 7	Bit 6	Bit 5	Bit 4	Bit 3	Bit 2	Bit 1	Bit 0
Not used	Not used	Not used	Not used	Not used	Running 0= Stopped 1= Running	Not used	Faulted 0= No fault 1= Fault

Bit 15	Bit 14	Bit 13	Bit 12	Bit 11	Bit 10	Bit 9	Bit 8
Not used	Not used	Not used	Not used	Not used	Not used	Not used	Not used

CIP Extended Speed Control (Assemblies 21 and 71)

- Assembly 21: CIP extended speed control output

The following table describes the assembly mapping:

Word Number	Definition
0	CIP extended command word
1	Speed setpoint (rpm)

The following table describes the CIP extended command word:

Bit 7	Bit 6	Bit 5	Bit 4	Bit 3	Bit 2	Bit 1 Bit 0
Not used	Network setpoint 0 = Setpoint by terminals 1= Setpoint by network	Network command 0 = Setpoint by terminals 1= Setpoint by network	Not used	Not used	Fault reset ⁽¹⁾ 0= No command 1= Fault reset	Run forward / reverse 00= Quick stop 01= Run forward 10= Run reverse 11= Freewheel stop

(1) Active on rising edge

Bit 15	Bit 14	Bit 13	Bit 12	Bit 11	Bit 10	Bit 9	Bit 8
Not used	Not used	Not used	Not used	Not used	Not used	Not used	Not used

Network setpoint and network address management

The assembly 21 uses the setpoint and reference switching of the Altivar 32. The VW3 A3 616, when configured with the assembly 21, links the bit 5 and the bit 6 to C312 and C313 respectively. To operate correctly, the Command settings of the ATV32 must be as follows:

Menu	Parameter	Permitted value
[COMMAND] (C L L -)	[Profile] (C H C F)	[Separate] (S E P)
[APPLICATION FUNCT.] (F U n -)	[Ref.1 channel] (F r 1)	[Com. card] (n E t)
[REFERENCE SWITCH.] (r E F -)	[Ref.2 channel] (F r 2)	[Ref. AI1] (R I 1) or [Ref. AI2] (R I 2)
	[Cmd channel 1] (C d 1)	[Com. card] (n E t)
	[Cmd channel 2] (C d 2)	[Terminals] (t E r)
	[Cmd switching] (C C S)	[C312] (C 3 1 2)
	[Ref.2 switching] (r F C)	[C313] (C 3 1 3)

- Assembly 71: CIP extended speed control input

The following table describes the assembly mapping:

Word Number	Definition
0	CIP extended status word
1	Actual speed (rpm)

The following table describes the CIP extended status word:

Bit 7	Bit 6	Bit 5	Bit 4	Bit 3	Bit 2	Bit 1	Bit 0
At reference 0= Reference not reached 1= Reference reached	Setpoint from network 0= Setpoint from terminals 1= Setpoint from network	Command from network 0= Command from terminals 1= Command from network	Ready 0= Not ready 1= Ready	Run forward / reverse 00= Stopped 01= Running forward 10= Running reverse 11= Not used	Warning 0= No warning 1= Warning	Not used	

Bit 15	Bit 14	Bit 13	Bit 12	Bit 11	Bit 10	Bit 9	Bit 8
Not used	Not used	Not used	Not used	Not used	Bit 8 to 10 are used for the drive state 000= Not used 001= Startup 010= Not ready 011= Ready 100= Enabled 101= Stopping 110= Fault stop 111= Faulted		

Messaging (Explicit Exchanges)

Introduction

All the ATV32 parameters can be accessed by R/W as CIP objects.

Altivar Parameters Path

The Altivar parameters are grouped in classes:

- Each application class has only 1 instance.
- Each instance groups 200 parameters.
- Each attribute in an instance relates to a parameter.

The first parameter registered in the first application class (class code: 16#70 = 112) has the logical address 3000.

Examples

The following table describes the examples of logical addresses:

Logical Address	Path Hexadecimal	Path Decimal
3000	16#70 / 01 / 01	112 / 1 / 1
3100	16#70 / 01 / 65	112 / 1 / 101
3200	16#71 / 01 / 01	113 / 1 / 1
64318	16#A2 / 1 / 77	418 / 1 / 119

An example of explicit messaging is shown below. The value of the ACC parameter (Modbus @ = 9001 / CIP address 16#2A:1:16#12) is modified when the variable "bit01" is toggled ON.

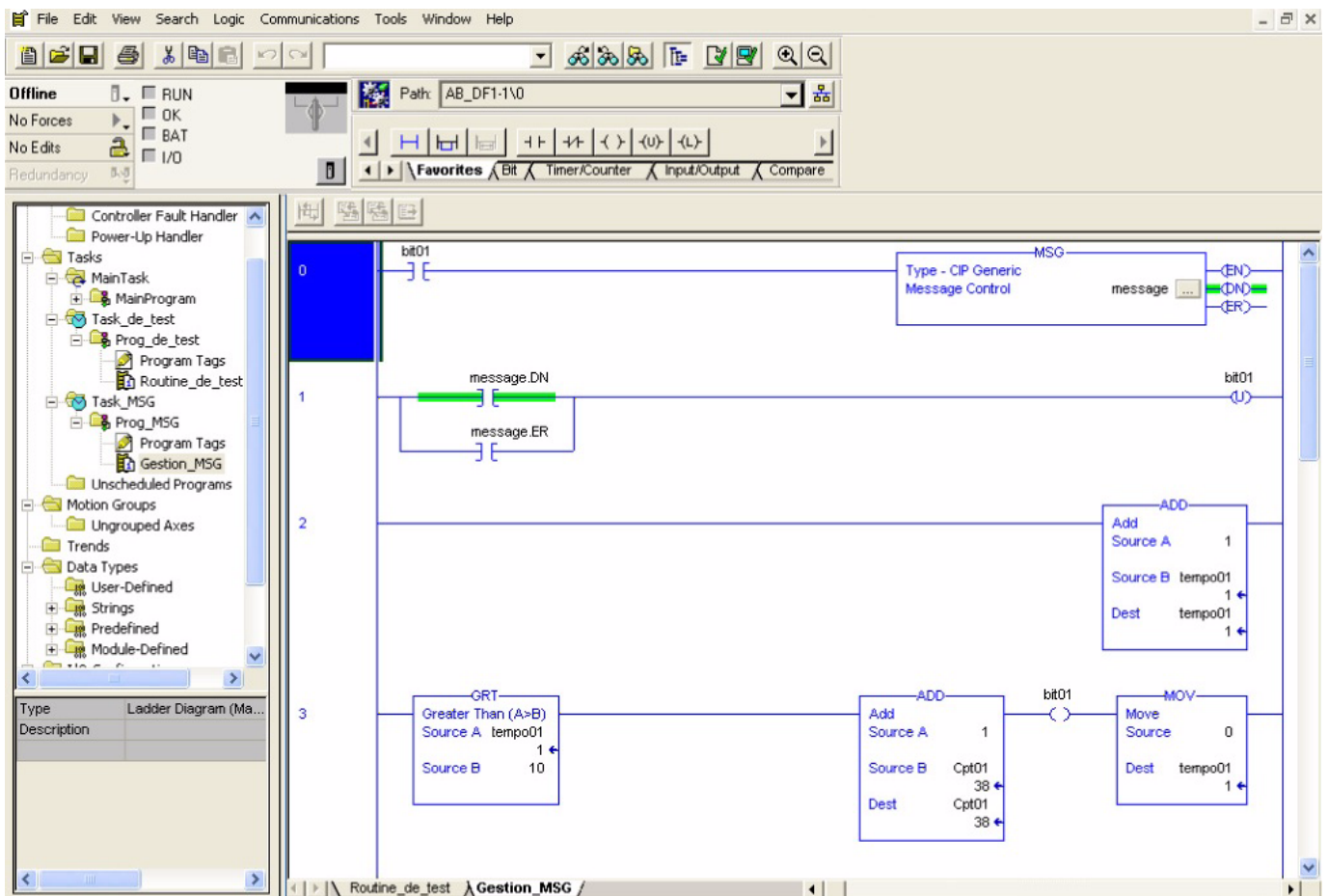

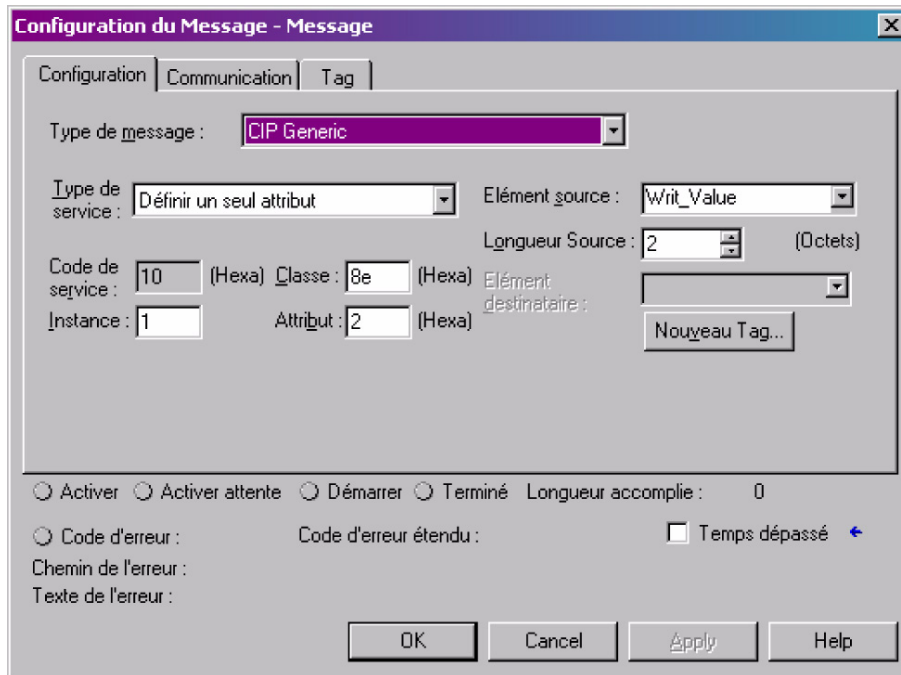

Detected Fault Management

An EtherNet/IP time out is triggered if the card does not receive any cyclic messages (within a predefined time period).

This period is managed by the EtherNet/IP controller (not by the drive) and is configured in its module properties box. The duration of the time out is defined by the RPI (Request packet intervals).

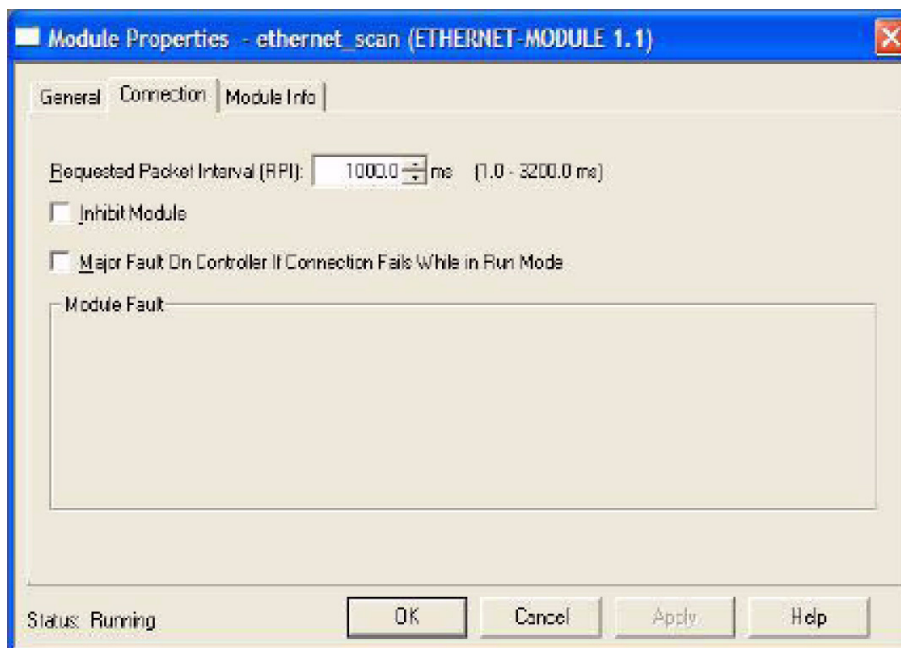

Configuration can be performed using the graphic display terminal or integrated display terminal using the **[Network fault mgt] (C L L)** parameter in the **[FAULT MANAGEMENT] (F L E -)** menu, **[COM. FAULT MANAGEMENT] (C L L -)** submenu.

ATV32 Configuration in ETC100

10

What's in this Chapter?

This chapter contains the following topics:

Topic	Page
Procedure	62
Explicit Messaging	67

Procedure

Create a New Project and Add the ETC100 Module

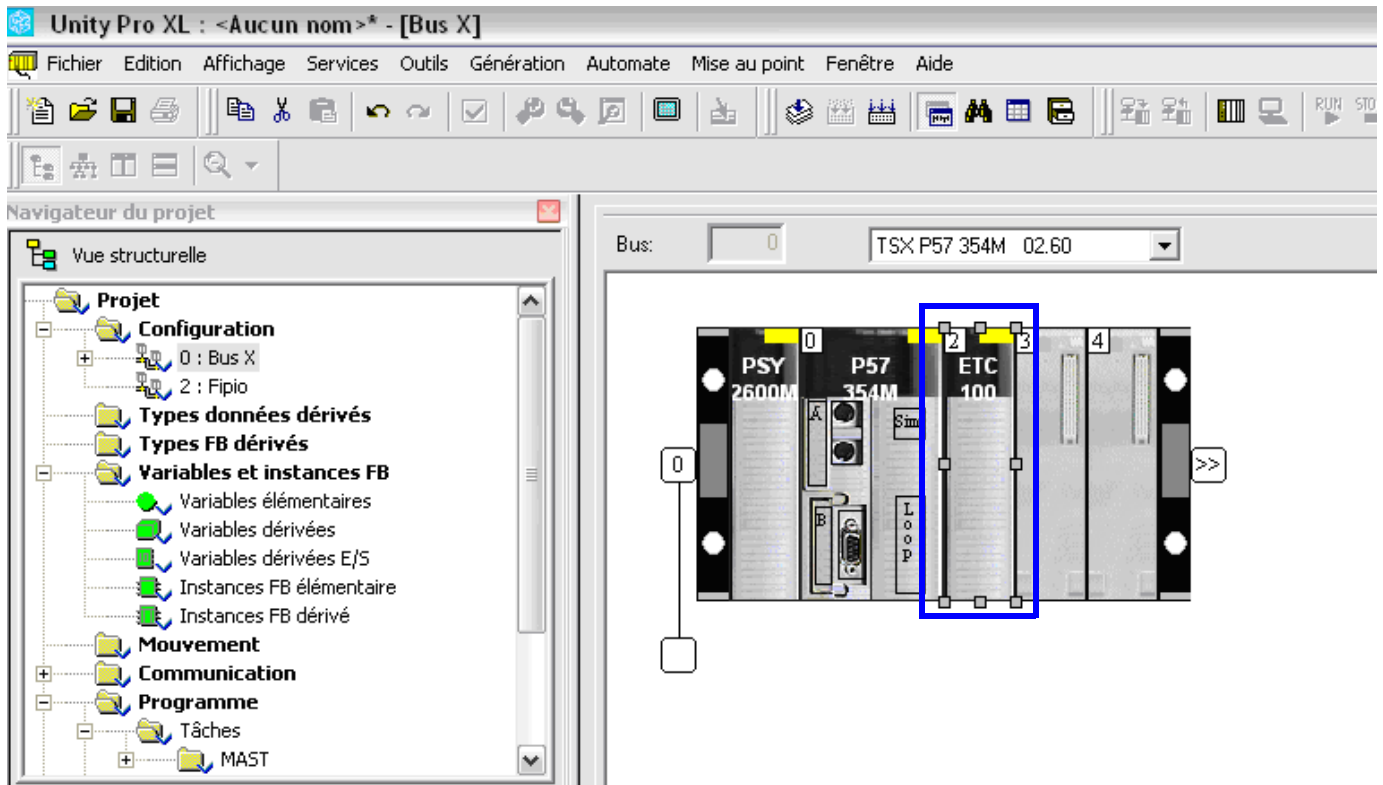

Open the ETC100 Module

- Choose the Network name (1)
- Choose the input and output size (2)
- Launch the Ethernet/IP configuration tool (3)

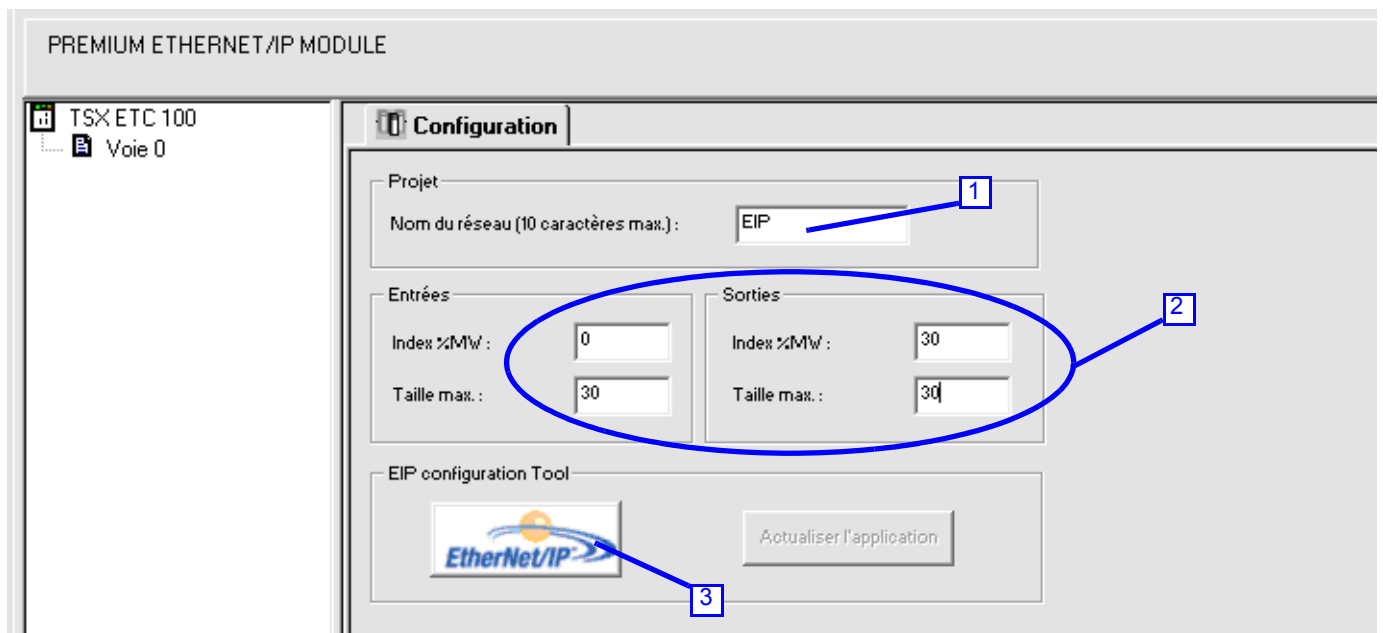

Define the ETC100 Network Parameter

- Double-click on ETC100 module (1)
- Configure ETC100 (2)
 - IP address
 - Mask
 - Gateway

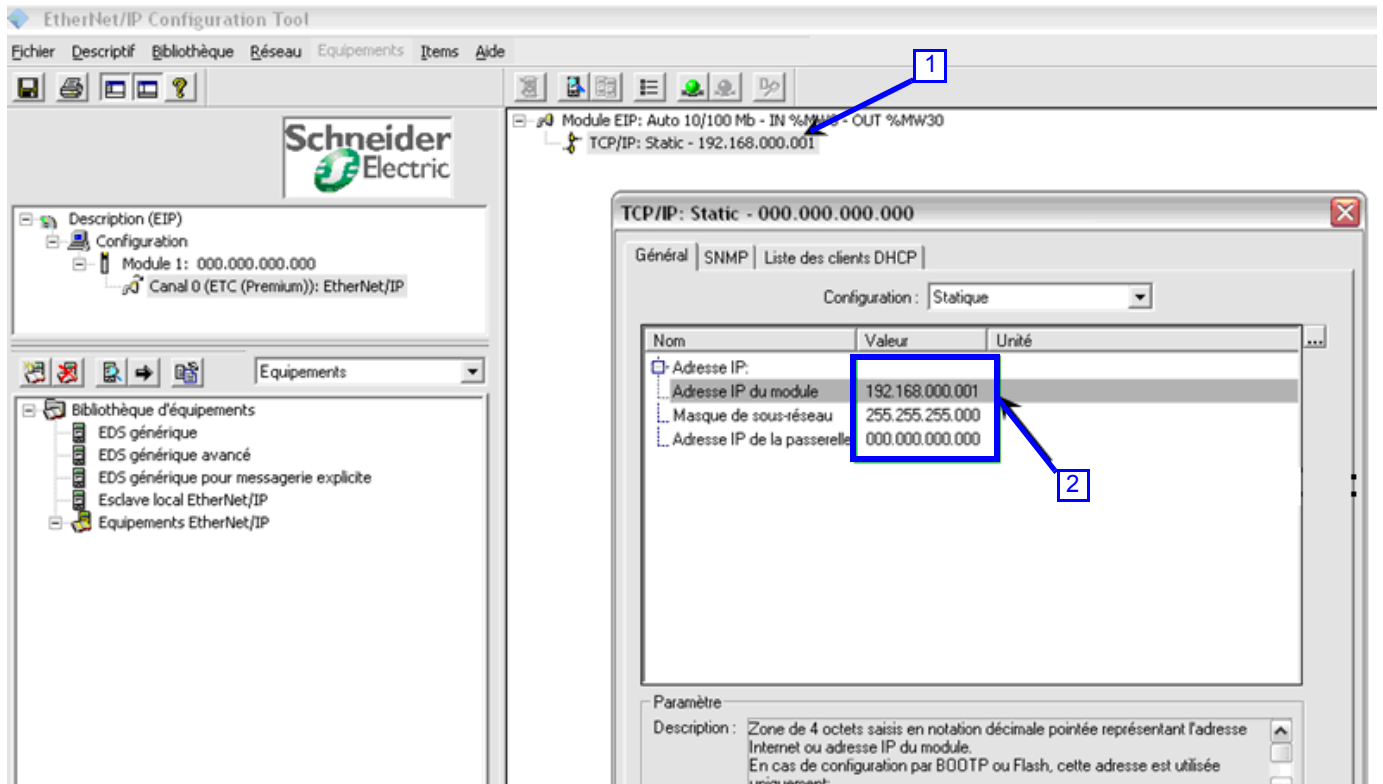

In EIP Configuration Tool, Insert the ATV32 EDS File

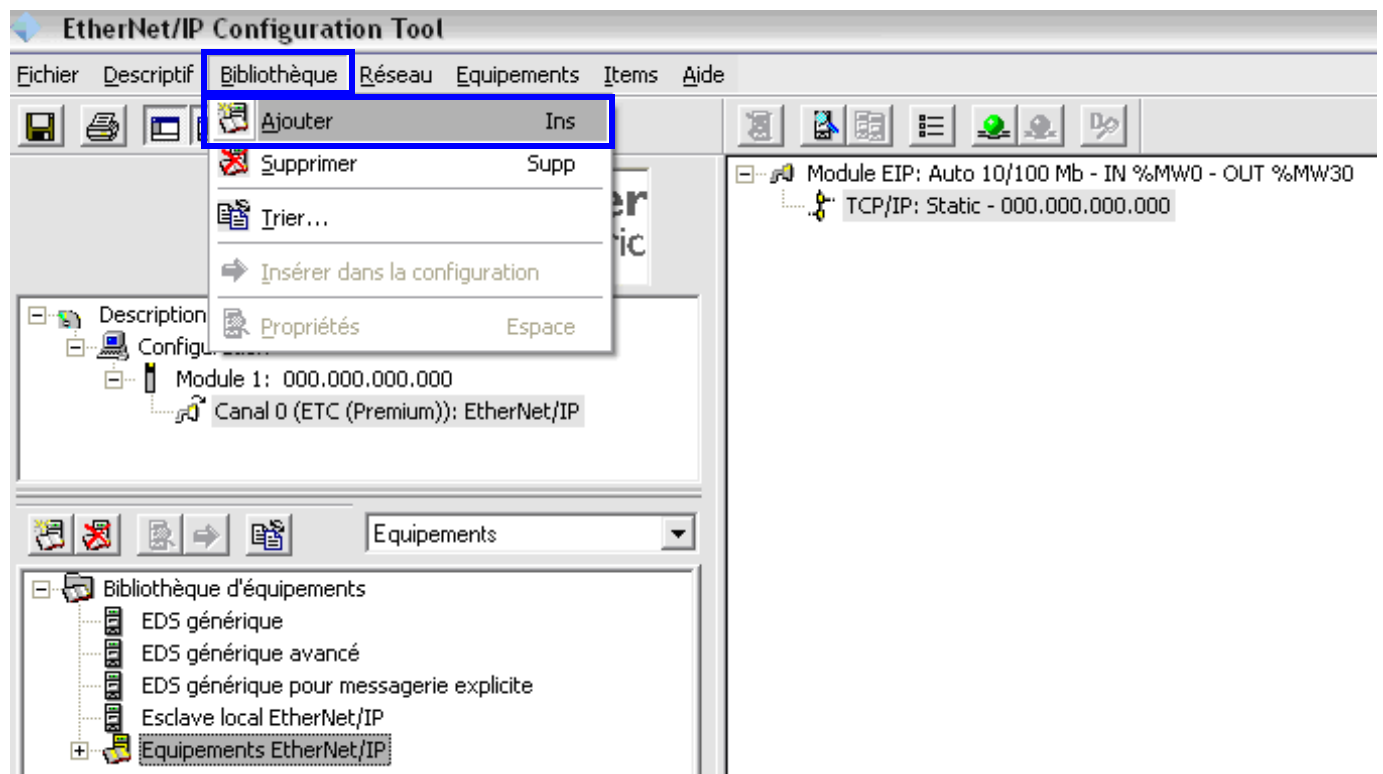

Follow the EIP configuration tool to add the ATV32 EDS file.

Add the ATV32

- Double-click on ATV32 (1)
- Choose a name (2)
- Select the device number (3)
- Select “link parameter” (4)
- Configure the ATV32 IP Address (5)

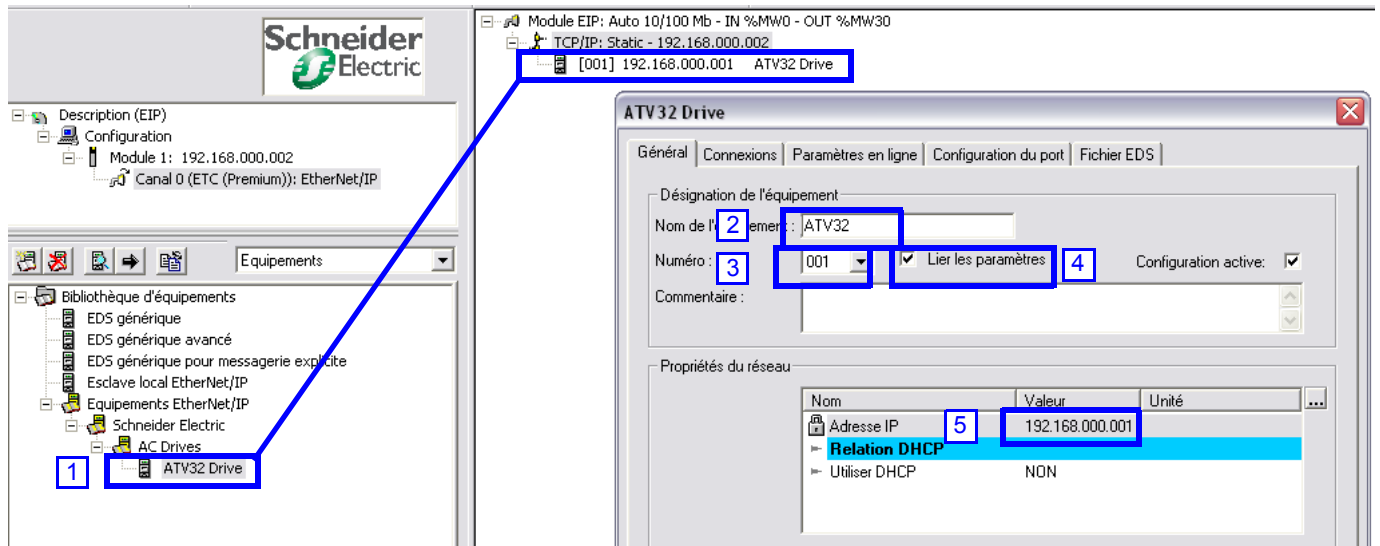

Assemblies Configuration

Here is a selection of Native drive control (Assembly 100-101):

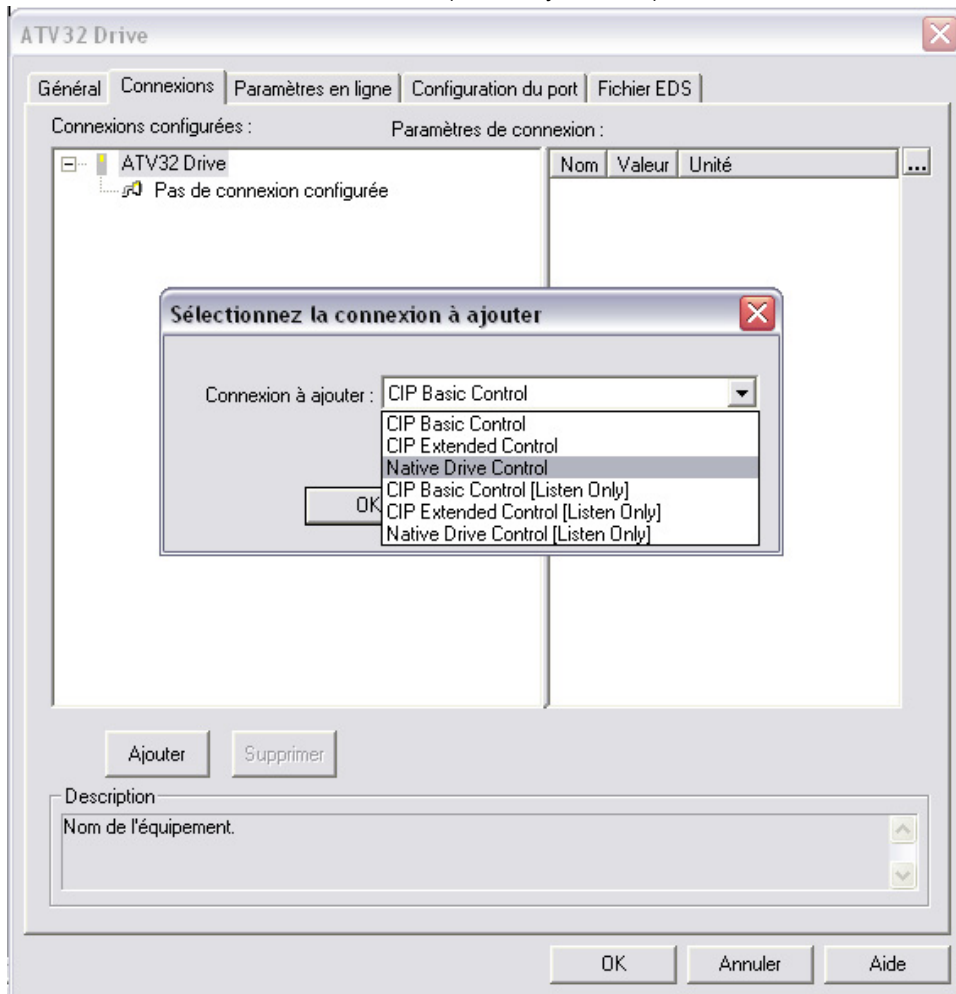

Item Configuration

This configuration pre-defines the input and output. This input and output can be used in UNITY.

- Double-click on assembly configured (1)
- Select all the items (2)
- Define the items (3)
- Choose “word” and click on OK (4)

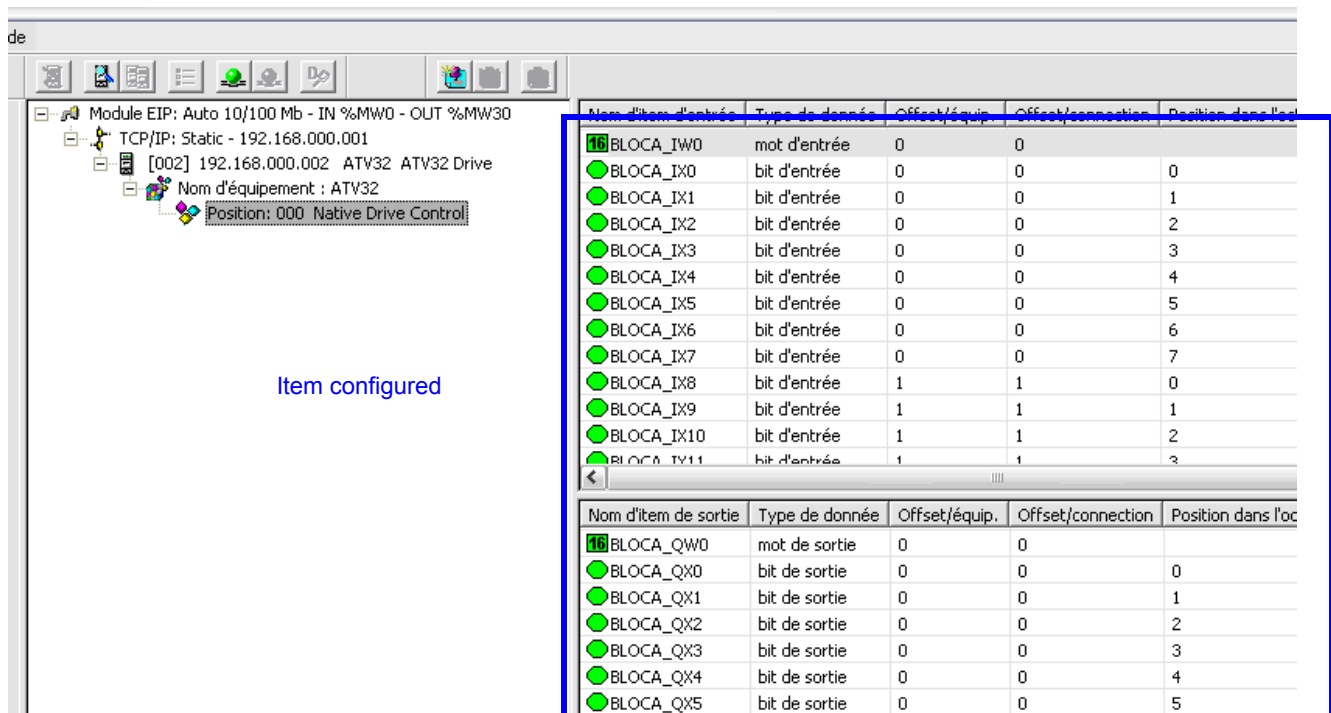
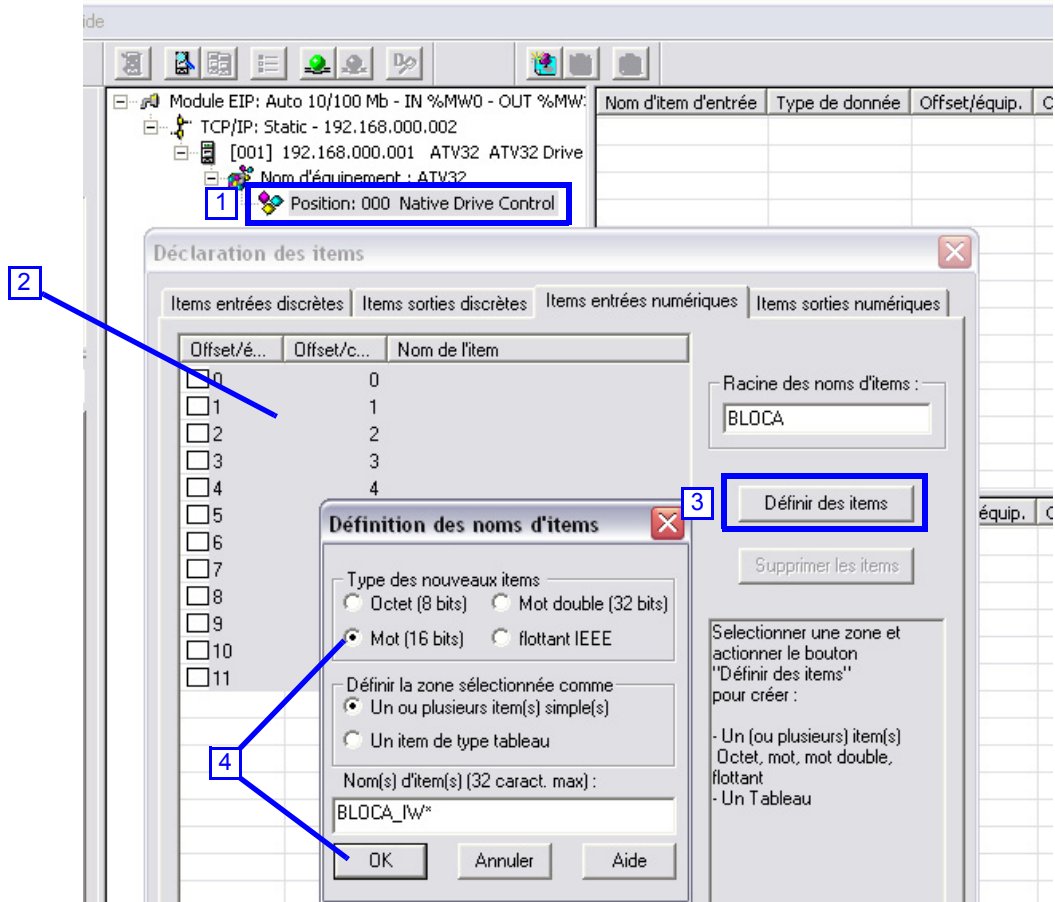

After this operation, you can save and close the EIP configuration tool.

Unity Update

When the configuration has been changed in the EIP configuration tool, it is necessary to update the UNITY configuration.

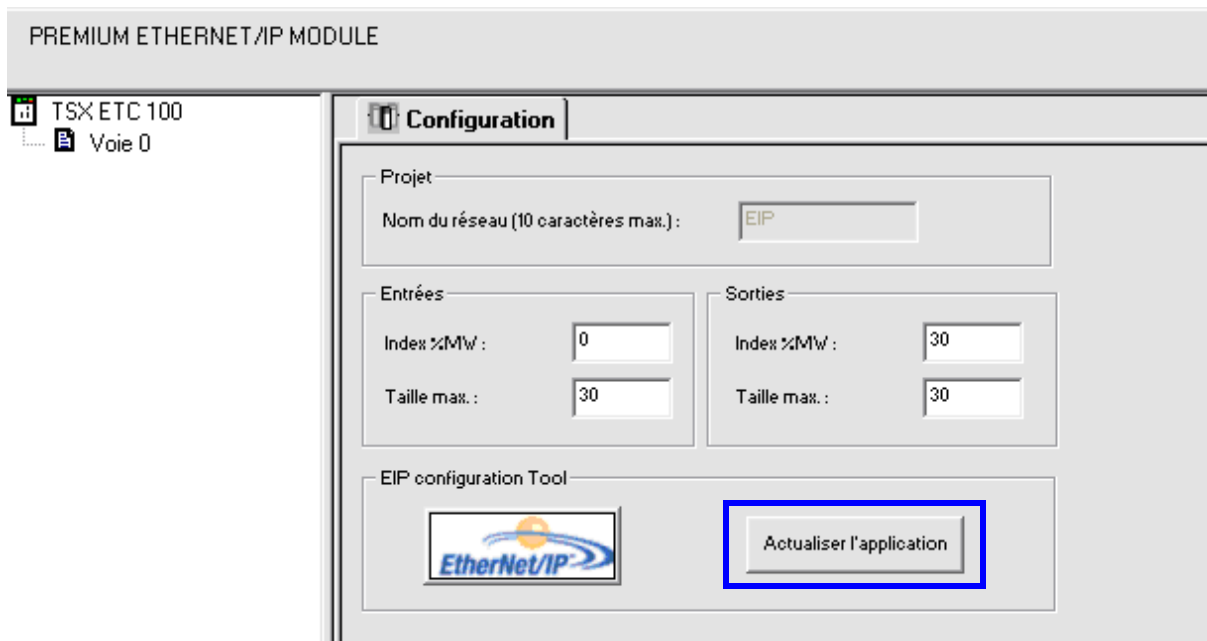

After this update, the Items configured in EIP configuration tool are present and can be used in UNITY program.

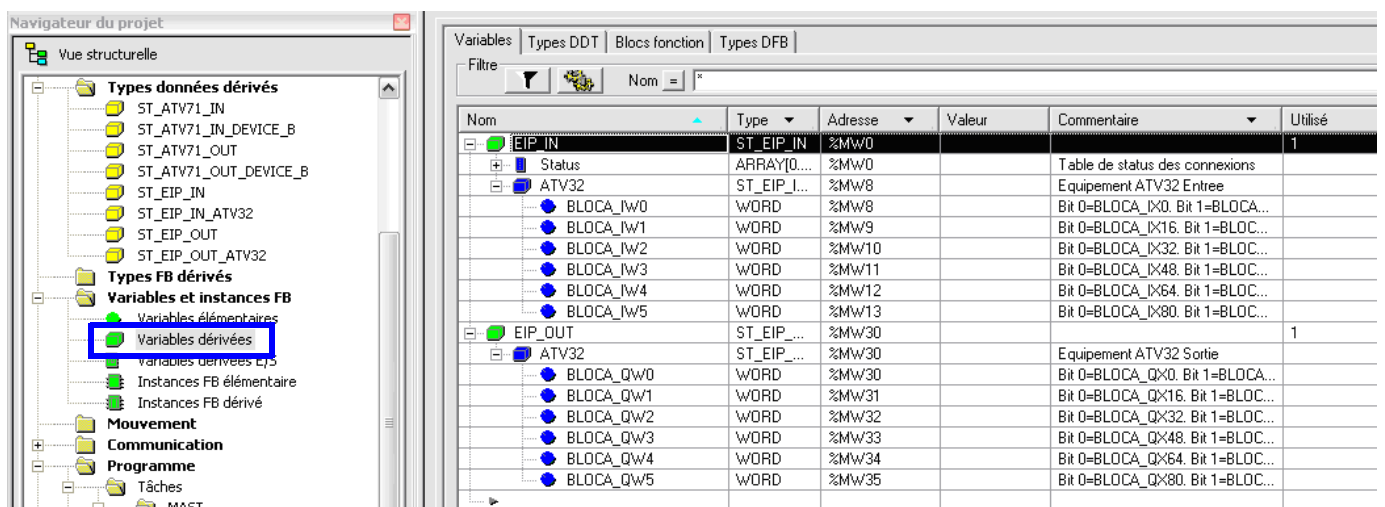

Explicit Messaging

An example of explicit messaging is shown below. The value of the ACC parameter (Modbus @ = 9001 / CIP address 16#8E:01:02).

Get Single Attribute

```
(*Get single attribut*)
if not reading_diagnostic [0] .0 and %M0 then
  reading_request_contents [0] :=16#0000; (*Reserved*)
  reading_request_contents [1] :=16#030E; (*03 - Request length in words / 0E - Get single*)
  reading_request_contents [2] :=16#8E20; (*Class*)
  reading_request_contents [3] :=16#0124; (*Instance*)
  reading_request_contents [4] :=16#0230; (*Attribut*)
  reading_diagnostic [3] :=16#0A; (*Fixed size of request in bytes*)
  SEND_REQ (addr('0.2.0.1'),16#000E,reading_request_contents,reading_diagnostic,reading_results);
  %M0:=False
End_if;
```

SEND_REQ description:

(0.2.0.1): Rack.location.way.equipment number

16#000E: messaging CIP (mandatory)

Set Single Attribute

```
(*Set single attribut*)
if not writing_diagnostic [0] .0 and %M1 then
  writing_request_contents [0] :=16#0000; (*Reserved*)
  writing_request_contents [1] :=16#0310; (*03 - Request length in words / 10 - SET single*)
  writing_request_contents [2] :=16#8E20; (*Class*)
  writing_request_contents [3] :=16#0124; (*Instance*)
  writing_request_contents [4] :=16#0230; (*Attribut*)
  writing_request_contents [5] :=35; (*value to write*)
  writing_diagnostic [3] :=16#0c; (*size of request in bytes*)
  SEND_REQ (addr('0.2.0.1'),16#000E,writing_request_contents,writing_diagnostic,writing_results);
  %M1:=False
End_if;
```

SEND_REQ description:

(0.2.0.1): Rack.location.way.equipment number

16#000E: messaging CIP (mandatory)

Get All Attribute

```
(*Get all attribut*)
if not reading_diagnostic_all [0] .0 and %M2 then
  reading_request_contents_all [0] :=16#0000; (*Reserved*)
  reading_request_contents_all [1] :=16#0201; (*02 - Request length in words / 01 - Get All*)
  reading_request_contents_all [2] :=16#8E20; (*Class*)
  reading_request_contents_all [3] :=16#0124; (*Instance*)
  reading_diagnostic_all [3] :=16#08; (*Fixed size of request in bytes*)
  SEND_REQ
(addr('0.2.0.1'),16#000E,reading_request_contents_all,reading_diagnostic_all,reading_results_all);
  %M2:=False
End_if;
```

SEND_REQ description:

(0.2.0.1): Rack.location.way.equipment number

16#000E: messaging CIP (mandatory)

Set All Attribute

```
(*Set all attribut*)
if not reading_diagnostic_all [0] .0 and %M3 then
  writing_request_contents_all [0] :=16#0000; (*Reserved*)
  writing_request_contents_all [1] :=16#0202; (*02 - Request length in words / 02 - SET All*)
  writing_request_contents_all [2] :=16#8E20; (*Class*)
  writing_request_contents_all [3] :=16#0124; (*Instance*)
  writing_diagnostic_all [3] :=16#2A; (*size of request in bytes*)
  SEND_REQ
(addr('0.2.0.1'),16#000E,writing_request_contents_all,writing_diagnostic_all,writing_results_all);
  %M3:=False
End_if;
```

SEND_REQ description:

(0.2.0.1): Rack.location.way.equipment number

16#000E: messaging CIP (mandatory)

Profiles

**11**

What's in this Chapter?

This chapter contains the following topics:

Topic	Page
Definition of a Profile	70
Functional Profiles Supported by the Altivar 32	71

Definition of a Profile

There are three types of profile:

- Communication profiles
- Functional profiles
- Application profiles

Communication Profiles

A communication profile describes the characteristics of the bus or network:

- Cables
- Connectors
- Electrical characteristics
- Access protocol
- Addressing system
- Periodic exchange service
- Messaging service
- ...

A communication profile is unique to a type of network (Modbus CIP, Profibus DP, etc.) and is used by various different types of device.

Functional Profiles

A functional profile describes the behavior of a type of device. It defines:

- Functions
- Parameters (name, format, unit, type, etc.)
- Periodic I/O variables
- State chart(s)
- ...

A functional profile is common to all members of a device family (variable speed drives, encoders, I/O modules, displays, etc.).

They can feature common or similar parts. The standardized (IEC 61800-7) functional profiles of variable speed drives are:

- CiA402
- PROFIDRIVE
- CIP

DRIVECOM has been available since 1991.

CiA402 "Device profile for drives and motion control" represents the next stage of this standard's development and is now part of the IEC 61800-7 standard.

Some protocols also support the ODVA (Open DeviceNet Vendor Association) profile.

Application Profiles

Application profiles define in their entirety the services to be provided by the devices on a machine. For example, "CiA DSP 417-2 V 1.01 part 2: CANopen application profile for lift control systems - virtual device definitions".

Interchangeability

The aim of communication and functional profiles is to achieve interchangeability of the devices connected via the network.

Functional Profiles Supported by the Altivar 32

I/O Profile

Using the I/O profile simplifies PLC programming.

The I/O profile mirrors the use of the terminal strip for control by utilizing 1 bit to control a function.

With an Altivar 32, the I/O profile can also be used when controlling via a network.

The drive starts up as soon as the run command is sent.

15 bits of the control word (bits 1 to 15) can be assigned to a specific function.

This profile can be developed for simultaneous control of the drive via:

- The terminals
- The Modbus control word
- The CANopen control word
- The network module control word

The I/O profile is supported by the drive itself and therefore in turn by all the communication ports (integrated Modbus, CANopen, Ethernet, Profibus DP, DeviceNet communication modules).

CiA402 Profile

The drive only starts up following a command sequence.

The control word is standardized.

5 bits of the control word (bits 11 to 15) can be assigned to a function.

The CiA402 profile is supported by the drive itself and therefore in turn by all the communication ports (integrated Modbus, CANopen, Ethernet, Profibus DP, DeviceNet communication modules).

The Altivar 32 supports the CiA402 profile's "Velocity mode".

In the CiA402 profile, there are two modes that are specific to the Altivar 32 and characterize command and reference management:

- Separate mode **[Separate] (SEP)**
- Not separate mode **[Not separ.] (IN)**

See "CiA402 - IEC61800-7 Functional Profile" on page 72.

CiA®402 - IEC61800-7 Functional Profile

12

What's in this Chapter?

This chapter contains the following topics:

Topic	Page
Functional Description	73
CiA402 State Chart	74
Description of States	75
Summary	76
Control Word (CMd)	77
Stop Commands	78
Assigning Control Word Bits	78
Status Word (EtA)	79
Starting Sequence	80
Sequence for a Drive Powered by the Power Section Line Supply	81
Sequence for a Drive With Separate Control Section	83
Sequence for a Drive With Line Contactor Control	86

Functional Description

Drive operation involves two main functions, which are illustrated in the diagrams below.

CiA402

The main parameters are shown with their CiA402 name and their CiA402/Drivecom index (the values in brackets are the CANopen addresses of the parameter).

Control diagram:

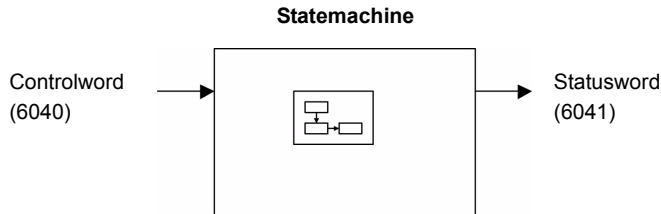

Simplified diagram of speed control in “Velocity” mode:

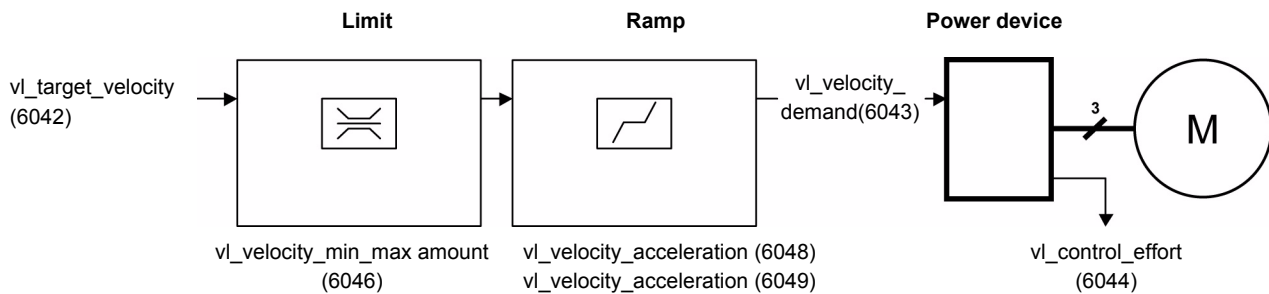

Altivar 32

These diagrams translate as follows for the Altivar system.

Control diagram:

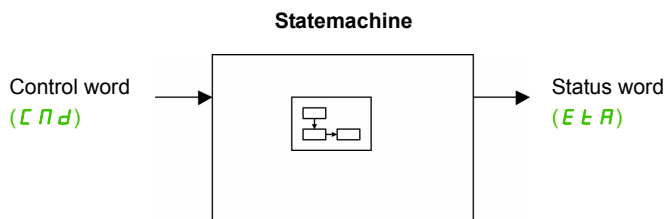

Simplified diagram of speed control in “Velocity” mode:

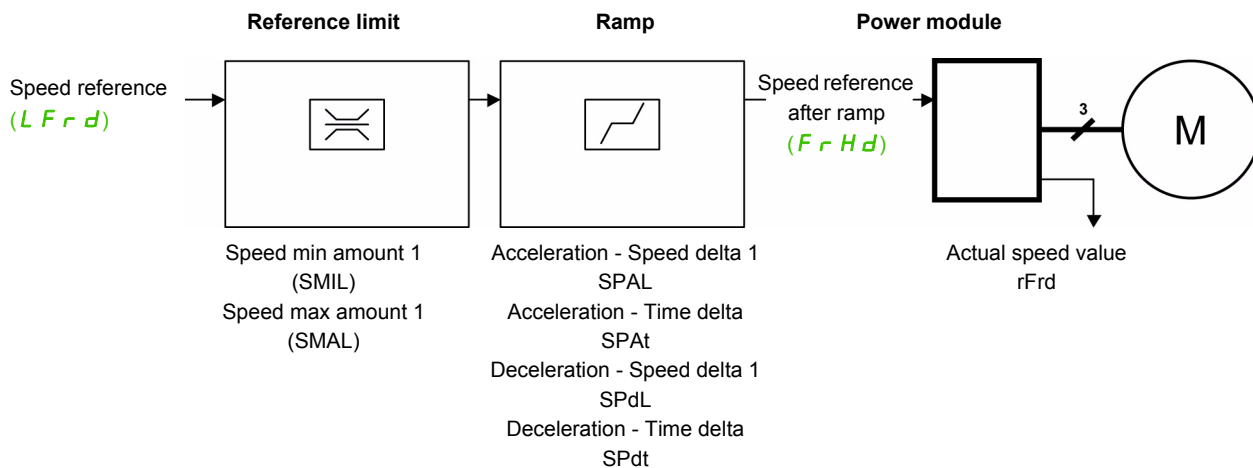

Description of States

Each state represents an internal reaction by the drive.

This chart will change depending on whether the control word is sent (**C P d**) or an event occurs (a detected fault, for example).

The drive state can be identified by the value of the status word (**E L R**).

State	Drive internal reaction
1 - Not ready to switch on	Initialization starts. This is a transient state invisible to the communication network.
2 - Switch on disabled	The drive is inactive. The drive is locked, no power is supplied to the motor. For a separate control section, it is not necessary to supply AC power to the power section. For a separate control section with line contactor, the contactor is not controlled. The configuration and adjustment parameters can be modified.
3 - Ready to switch on	Awaiting power section line supply. For a separate control section, it is not necessary to supply AC power to the power section, but the system will expect it in order to change to state "4 - Switched on". For a separate control section with line contactor, the contactor is not controlled. The drive is locked, no power is supplied to the motor. The configuration and adjustment parameters can be modified.
4 - Switched on	The drive is supplied with AC power but is stationary. For a separate control section, the power section line supply must be present. For a separate control section with line contactor, the contactor is controlled. The drive is locked, no power is supplied to the motor. The power stage of the drive is ready to operate, but voltage has not yet been applied to the output. The adjustment parameters can be modified. Modification of a configuration parameter returns the drive to state "2 - Switch on disabled".
5 - Operation enabled	The drive is running. For a separate control section, the power section line supply must be present. For a separate control section with line contactor, the contactor is controlled. The drive is unlocked, power is supplied to the motor. The drive functions are activated and voltage is applied to the motor terminals. If the reference is zero or the "Halt" command is applied, no power is supplied to the motor and no torque is applied. [Auto tuning] (E U n) requires an injection of current into the motor. The drive must therefore be in state "5 - Operation enabled" for this command. The adjustment parameters can be modified. The configuration parameters cannot be modified. NOTE: The command "4 - Enable operation" must be taken into consideration only if the channel is valid. In particular, if the channel is involved in the command and the reference, transition 4 will take place only after the reference has been received for the first time. The reaction of the drive to a "Disable operation" command depends on the value of the [Dis. operat opt code] (d D E d) parameter: <ul style="list-style-type: none"> - If the [Dis. operat opt code] (d D E d) parameter has the value 0, the drive changes to "4 - Switched on" and stops in freewheel stop. - If the [Dis. operat opt code] (d D E d) parameter has the value 1, the drive stops on ramp and then changes to "4 - Switched on".
6 - Quick stop active	Emergency stop. The drive performs a fast stop, after which restarting will only be possible once the drive has changed to the "Switch on disabled" state. During fast stop, the drive is unlocked and power is supplied to the motor. The configuration parameters cannot be modified. The condition for transition 12 to state "2 - Switch on disabled" depends on the value of the parameter Quick stop mode (QStd): If the Quick stop mode parameter has the value FST2, the drive stops according to the fast stop ramp and then changes to state "2 - Switch on disabled". If the Quick stop mode parameter has the value FST6, the drive stops according to the fast stop ramp and then remains in state "6 - Quick stop active" until: <ul style="list-style-type: none"> - A "Disable voltage" command is received. - Or the STOP key is pressed. - Or there is a freewheel stop command via the terminals.

State	Drive internal reaction
7 - Fault reaction active	Transient state during which the drive performs an action appropriate to the type of detected fault. The drive function is activated or deactivated according to the type of reaction configured in the detected fault management parameters.
8 - Fault	Drive has detected a fault. The drive is locked, no power is supplied to the motor.

Summary

State	Power section line supply for separate control section	Power supplied to motor	Modification of configuration parameters
1 - Not ready to switch on	Not required	No	Yes
2 - Switch on disabled	Not required	No	Yes
3 - Ready to switch on	Not required	No	Yes
4 - Switched on	Required	No	Yes, return to "2 - Switch on disabled" state
5 - Operation enabled	Required	Yes	No
6 - Quick stop active	Required	Yes, during fast stop	No
7 - Fault reaction active	Depends on detected fault management configuration	Depends on detected fault management configuration	-
8 - Fault	Not required	No	Yes

Control Word (C П d)

bit 7	bit 6	bit 5	bit 4	bit 3	bit 2	bit 1	bit 0
Fault reset	Reserved (=0)	Reserved (=0)	Reserved (=0)	Enable operation	Quick stop	Enable voltage	Switch on
0 to 1 transition = Ack. fault				1 = Run command	0 = Emergency stop	Authorization to supply AC power	Contactor control

bit 15	bit 14	bit 13	bit 12	bit 11	bit 10	bit 9	bit 8
Manufacturer specific Assignable	Manufacturer specific Assignable	Manufacturer specific Assignable	Manufacturer specific Assignable	Manufacturer specific	Reserved (=0)	Reserved (=0)	Halt
				0 = Forward direction asked 1= Reverse direction asked			Halt

Command	Transition address	Final state	bit 7	bit 3	bit 2	bit 1	bit 0	Example value
			Fault reset	Enable operation	Quick stop	Enable voltage	Switch on	
Shutdown	2, 6, 8	3 - Ready to switch on	x	x	1	1	0	16#0006
Switch on	3	4 - Switched on	x	x	1	1	1	16#0007
Enable operation	4	5 - Operation enabled	x	1	1	1	1	16#000F
Disable operation	5	4 - Switched on	x	0	1	1	1	16#0007
Disable voltage	7, 9, 10, 12	2 - Switch on disabled	x	x	x	0	x	16#0000
Quick stop	11	6 - Quick stop active	x	x	0	1	x	16#0002
	7, 10	2 - Switch on disabled						
Fault reset	15	2 - Switch on disabled	0 → 1	x	x	x	x	16#0080

x: Value is of no significance for this command.

0 → 1: Command on rising edge.

Stop Commands

The “Halt” command enables movement to be interrupted without having to leave the “5 - Operation enabled” state. The stop is performed in accordance with the **[Type of stop] (S E E)** parameter.

If the “Halt” command is active, no power is supplied to the motor and no torque is applied.

Regardless of the assignment of the **[Type of stop] (S E E)** parameter (**[Fast stop assign] (F S E)**, **[Ramp stop] (r P P)**, **[Freewheel] (r S E)**, or **[DC injection assign.] (d C I)**), the drive remains in the “5 - Operation enabled” state.

A Fast Stop command at the terminals or using a bit of the control word assigned to Fast Stop causes a change to the “4 - Switched on” state. A “Halt” command does not cause this transition.

A Freewheel Stop command at the terminals or using a bit of the control word assigned to Freewheel Stop causes a change to the “2 - Switch on disabled” state. A “Halt” command does not cause this transition.

Assigning Control Word Bits

In the CiA402 profile, fixed assignment of a function input is possible using the following codes:

Bit	Network module
bit 11	C311
bit 12	C312
bit 13	C313
bit 14	C314
bit 15	C315

For example, to assign the DC injection braking to bit 13 of Ethernet, simply configure the **[DC injection assign.] (d C I)** parameter with the **[C313] (C 3 I 3)** value.

Bit 11 is assigned by default to the operating direction command **[Reverse assign.] (r r 5)**.

Status Word (E L F)

bit 7	bit 6	bit 5	bit 4	bit 3	bit 2	bit 1	bit 0
Warning	Switch on disabled	Quick stop	Voltage enabled	Fault	Operation enabled	Switched on	Ready to switch on
Alarm	Power section line supply disabled	0 = Emergency stop	Power section line supply present	Fault	Running	Ready	1 = Awaiting power section line supply

bit 15	bit 14	bit 13	bit 12	bit 11	bit 10	bit 9	bit 8
Manufacturer specific Direction of rotation	Manufacturer specific Stop via STOP key	Reserved (=0)	Reserved (=0)	Internal limit active	Target reached	Remote	Reserved (=0)
				Reference outside limits	Reference reached	Command or reference via network	

Status	bit 6	bit 5	bit 4	bit 3	bit 2	bit 1	bit 0	ETA masked by 16#006F ⁽¹⁾
	Switch on disabled	Quick stop	Voltage enabled	Fault	Operation enabled	Switched on	Ready to switch on	
1 -Not ready to switch on	0	x	x	0	0	0	0	-
2 -Switch on disabled	1	x	x	0	0	0	0	16#0040
3 -Ready to switch on	0	1	x	0	0	0	1	16#0021
4 -Switched on	0	1	1	0	0	1	1	16#0023
5 -Operation enabled	0	1	1	0	1	1	1	16#0027
6 -Quick stop active	0	0	1	0	1	1	1	16#0007
7 -Fault reaction active	0	x	x	1	1	1	1	-
8 -Fault	0	x	x	1	0	0	0	16#0008 ⁽²⁾ or 16#0028

(1) This mask can be used by the PLC program to test the chart state.

(2) Detected fault following state "6 - Quick stop active".

x: In this state, the value of the bit can be 0 or 1.

Starting Sequence

The command sequence in the state chart depends on how power is being supplied to the drive.

There are three possible scenarios:

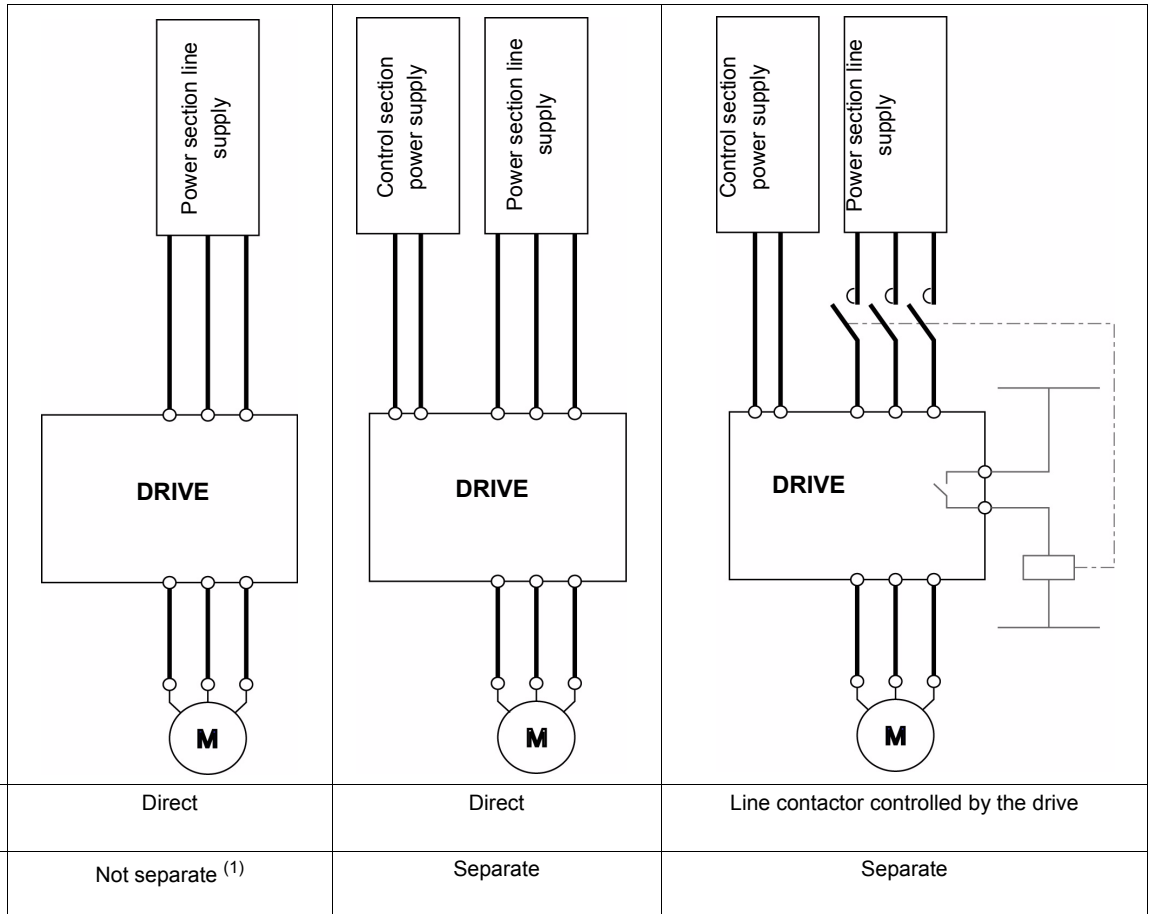

(1) The power section supplies the control section.

Sequence for a Drive Powered by the Power Section Line Supply

Both the power and control sections are powered by the power section line supply.
 If power is supplied to the control section, it has to be supplied to the power section as well.
 The following sequence must be applied:

Step 1

Send the "2 - Shutdown" command

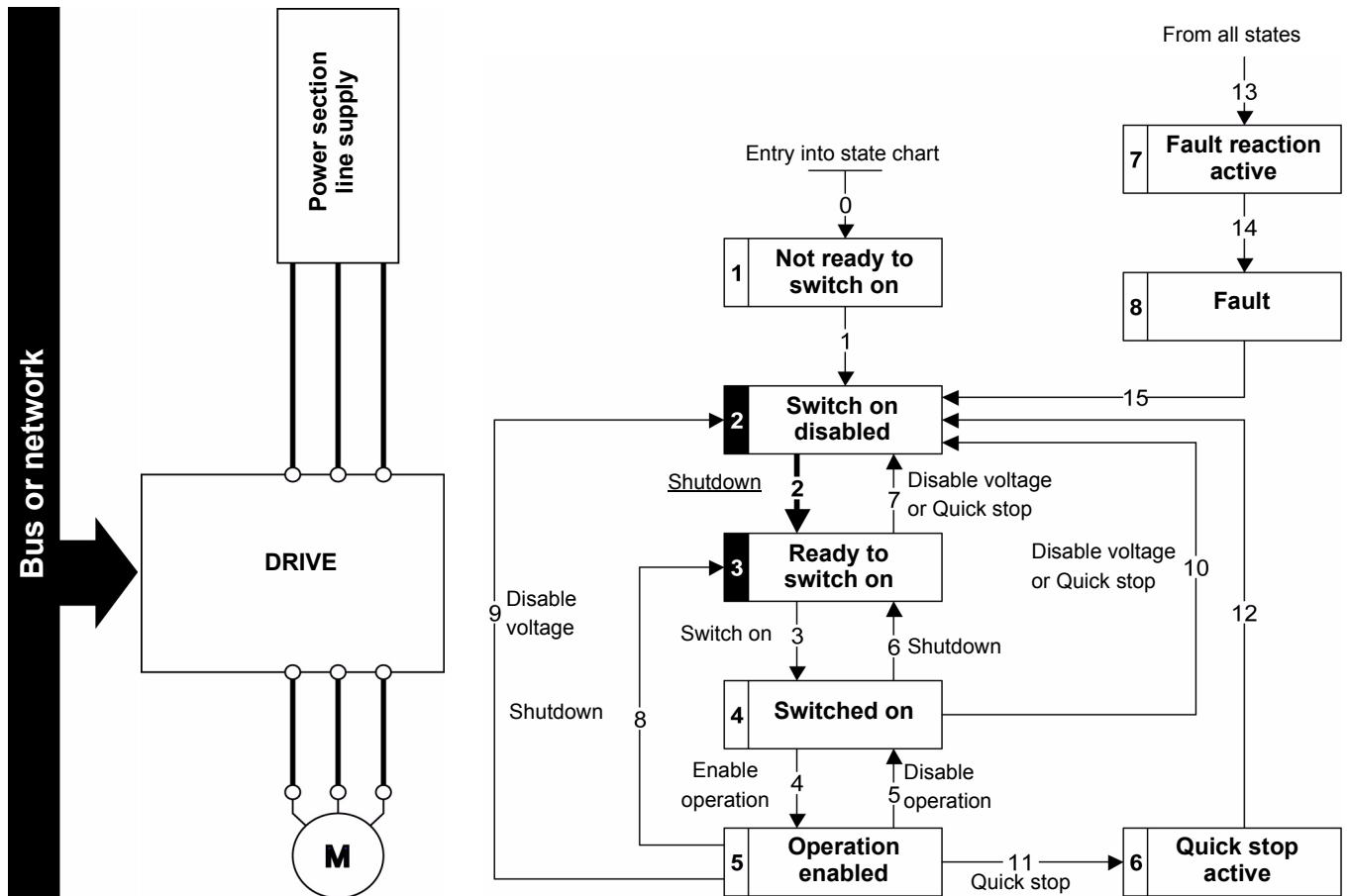

Step 2

- Check that the drive is in the “3 - Ready to switch on” state.
- Then send the “4 - Enable operation” command.
- The motor can be controlled (send a reference not equal to zero).

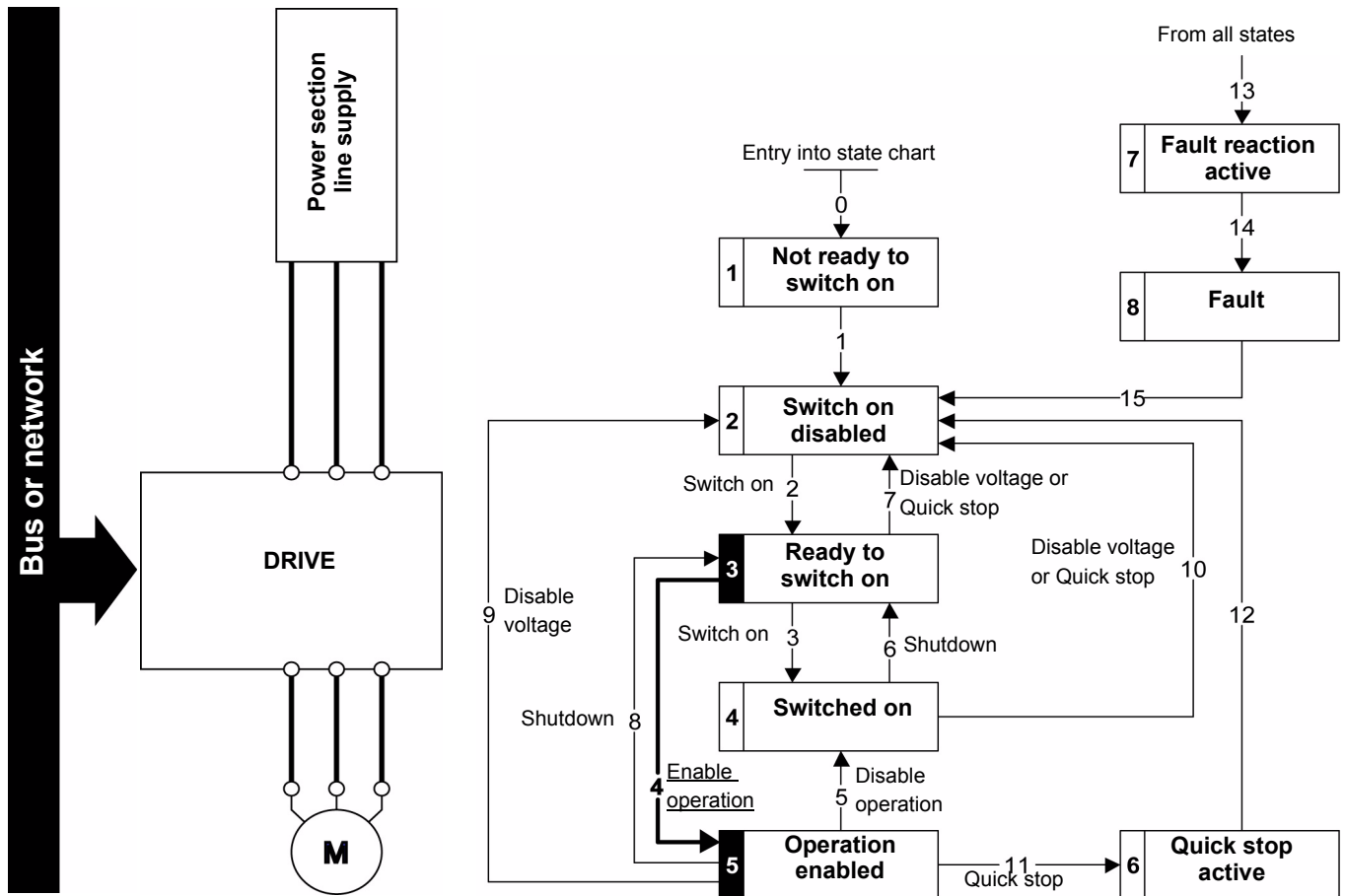

NOTE: It is possible, but not necessary, to send the “3 - Switch on” command followed by the “4 - Enable Operation” command to switch successively into the states “3 - Ready to Switch on”, “4 - Switched on” and then “5 - Operation Enabled”.
The “4 - Enable operation” command is sufficient.

Sequence for a Drive With Separate Control Section

Power is supplied separately to the power and control sections.

If power is supplied to the control section, it does not have to be supplied to the power section as well.

The following sequence must be applied:

Step 1

- The power section line supply is not necessarily present.
- Send the “2 - Shutdown” command

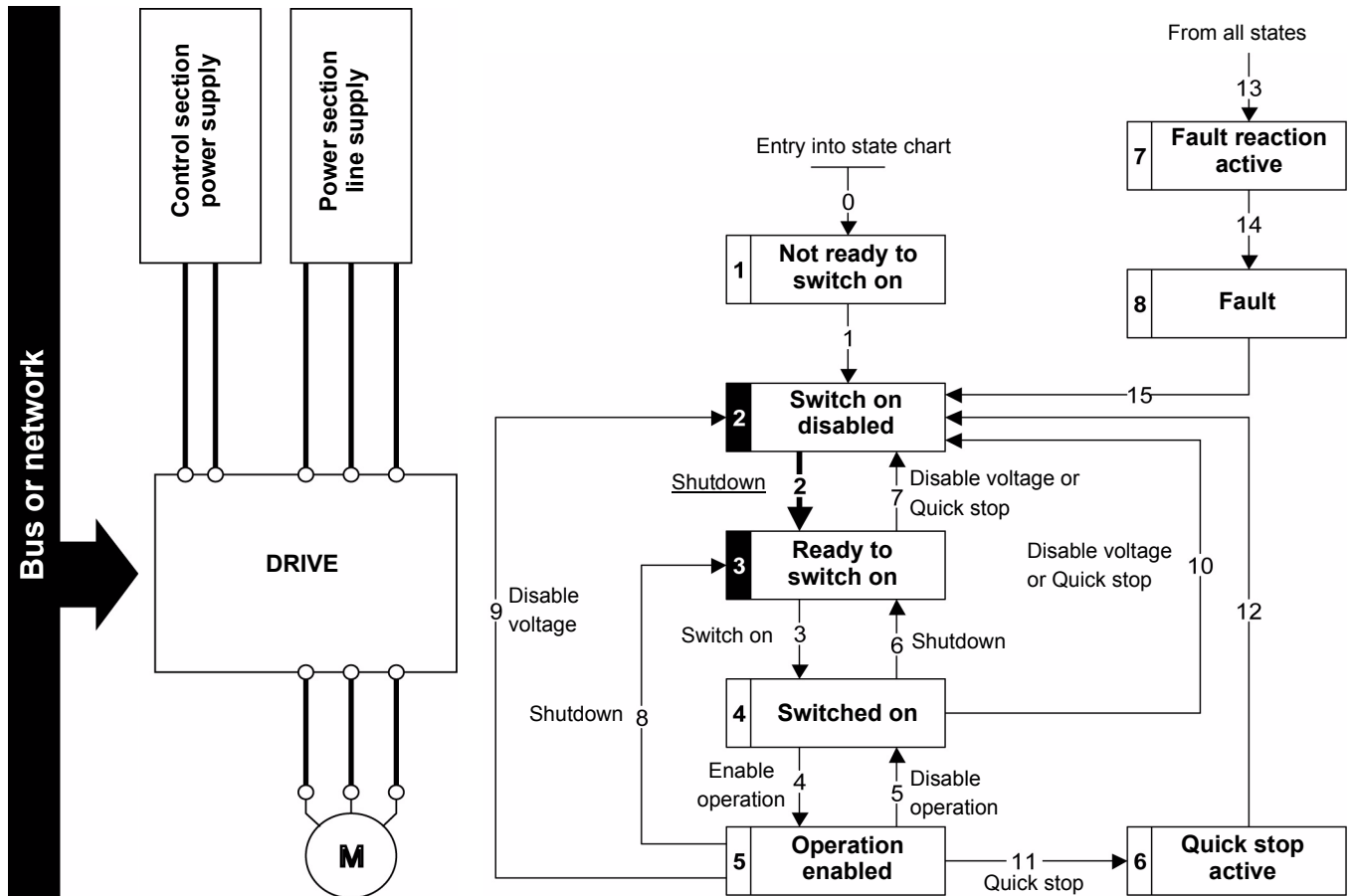

Step 2

- Check that the drive is in the “3 - Ready to switch on” state.
- Check that the power section line supply is present (“Voltage enabled” of the status word).

Power section line supply	Terminal display	Status word
Absent	nLP	16#●●21
Present	rdY	16#●●31

- Send the “3 - Switch on” command

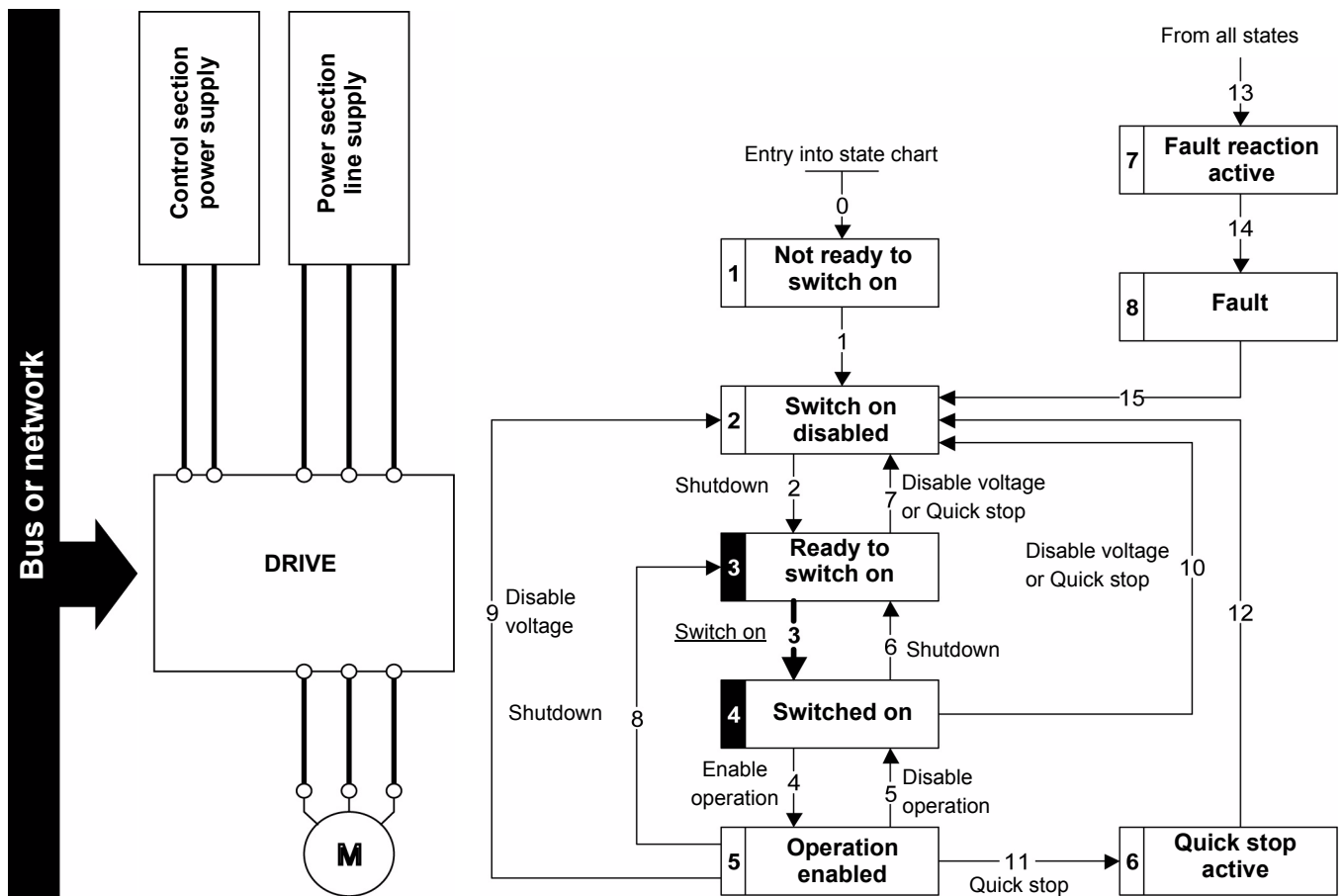

Step 3

- Check that the drive is in the “4 - Switched on” state.
- Then send the “4 - Enable operation” command.
- The motor can be controlled (send a reference not equal to zero).
- If the power section line supply is still not present in the “4 - Switched on” state after a time delay **[Mains V. time out] (L C E)**, the drive will switch to detected fault mode **[input contactor] (L C F)**.

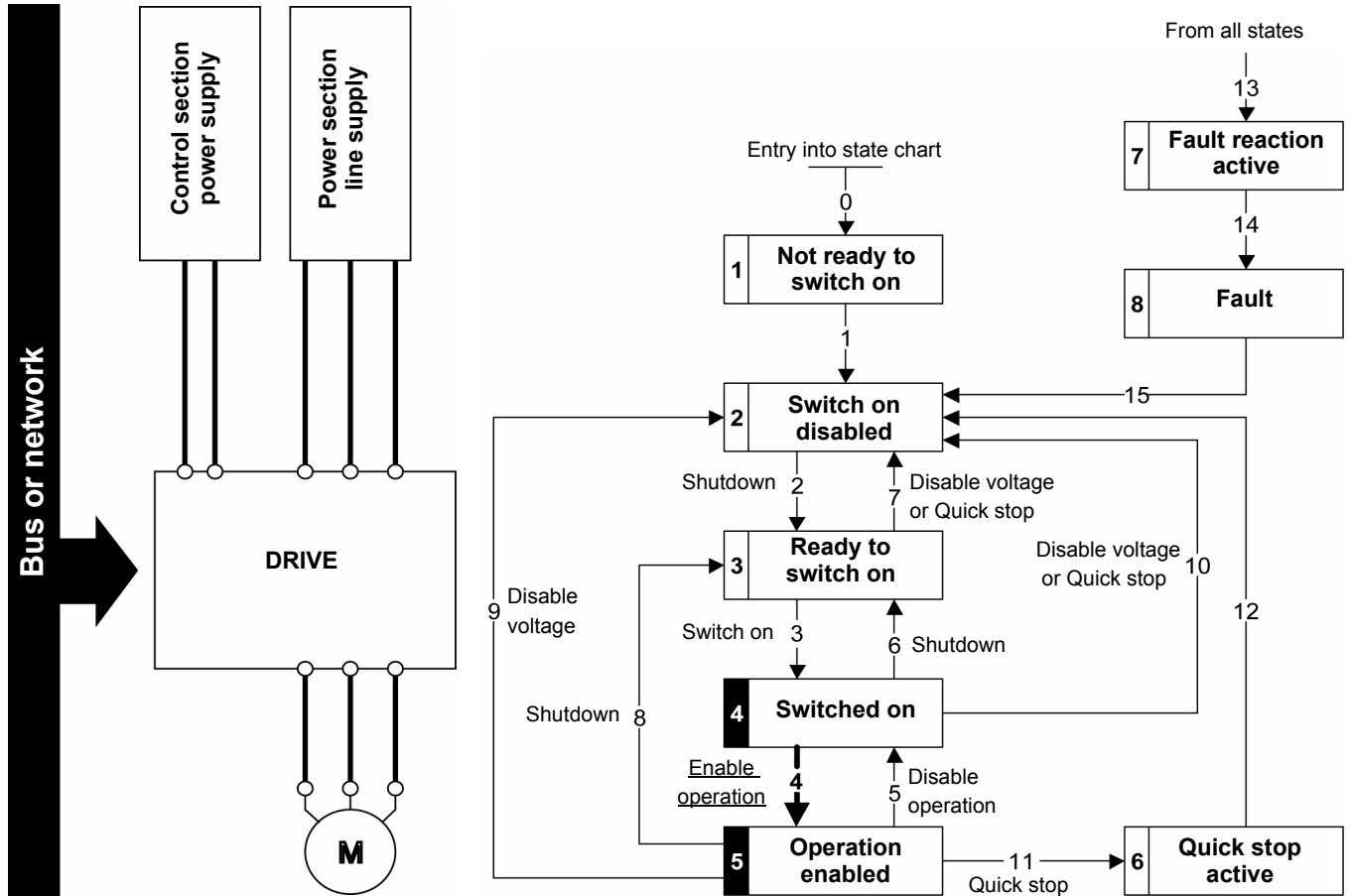

Sequence for a Drive With Line Contactor Control

Power is supplied separately to the power and control sections.

If power is supplied to the control section, it does not have to be supplied to the power section as well. The drive controls the line contactor.

The following sequence must be applied:

Step 1

- The power section line supply is not present as the line contactor is not being controlled.
- Send the “2 - Shutdown” command

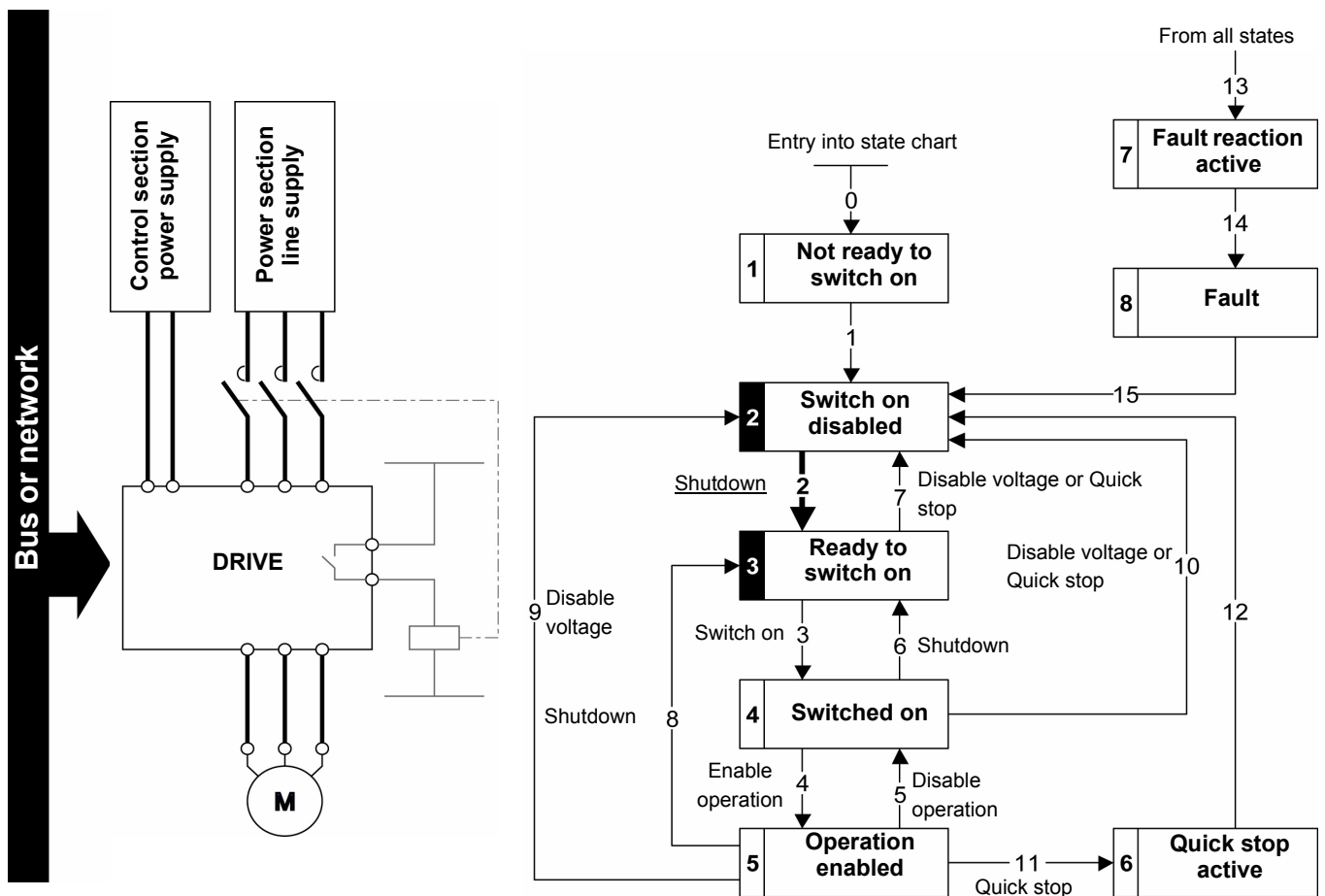

Step 2

- Check that the drive is in the “3 - Ready to switch on” state.
- Send the “3 - Switch on” command, which will close the line contactor and switch on the power section line supply.

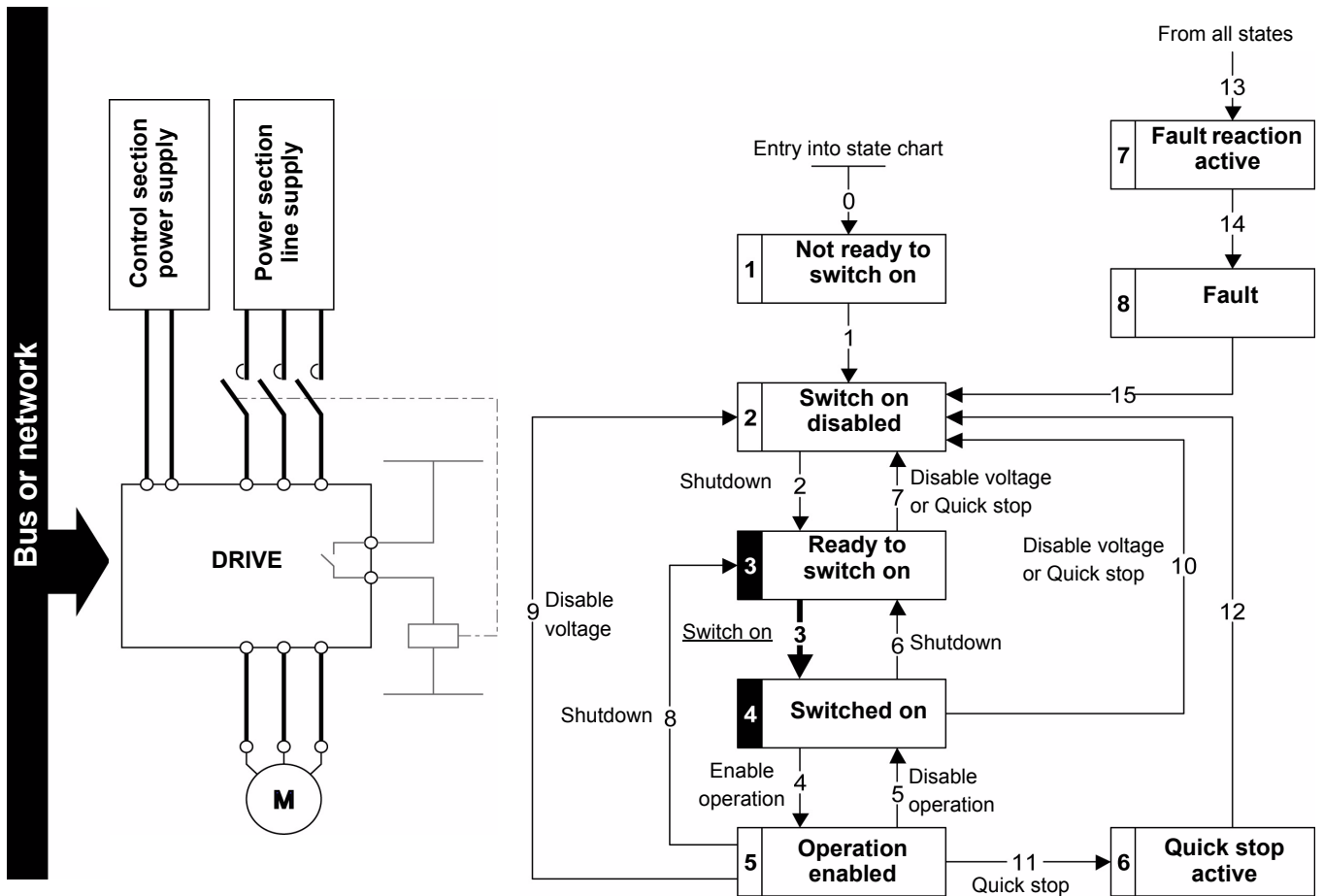

CIP Objects Overview

**13**

Overview

This chapter shows an overview of the CIP objects. For more details, please refer to the “CIP Objects” on page 123.

What's in this Chapter?

This chapter contains the following topics:

Topic	Page
Objects in the AC/DC Drive Device	89
Object 28hex (Motor Data)	89
Object 29hex (Control Supervisor)	90
Object 2Ahex (AC/DC Drive)	91

Objects in the AC/DC Drive Device

The following table gives the list of objects that shall be implemented in the options:

Object	Description
Identity	This object provides identification of and general information about the device
Message Router	The Message Router Object provides a messaging connection point through which a Client may address a service to any object class or instance residing in the physical device
Ethernet Link	The Ethernet Link Object maintains link-specific counters and status information for a Ethernet 802.3 communications interface
TCP/IP Interface	The TCP/IP Interface Object provides the mechanism to configure a device's TCP/IP network interface. Examples of configurable items include the device's IP Address, Network Mask, and Gateway Address
Connection manager	Use this object for connection and connectionless communications, including establishing connections across multiple subnets
Assemblies	The Assembly Object binds attributes of multiple objects, which allows data to or from each object to be sent or received over a single connection
Control supervisor	Manages drive functions, operational states and control
AC/DC drive	Provides drive configuration
Motor data	Defines motor data for the motor connected to the device

Object 28hex (Motor Data)

Path	CIP name	Altivar name
16#28/01/03 = 40/1/3	MotorType	Squirrel Cage Induction Motor
16#28/01/06 = 40/1/6	RatedCurrent	Rated mot. current
16#28/01/07 = 40/1/7	RatedVoltage	Rated motor volt.
16#28/01/09 = 40/1/9	RatedFreq	Rated motor freq.
16#28/01/0F = 40/1/15	BaseSpeed	Rated motor speed

Object 29hex (Control Supervisor)

Path	CIP name	Altivar name
16#29/01/03 = 41/1/3	Run1	-
16#29/01/07 = 41/1/7	Running1	-
16#29/01/0A = 41/1/10	Faulted	-
16#29/01/0C = 41/1/12	FaultRst	-
16#29/01/0D = 41/1/13	FaultCode	CiA402 detected fault code

Control Supervisor State Transition Diagram

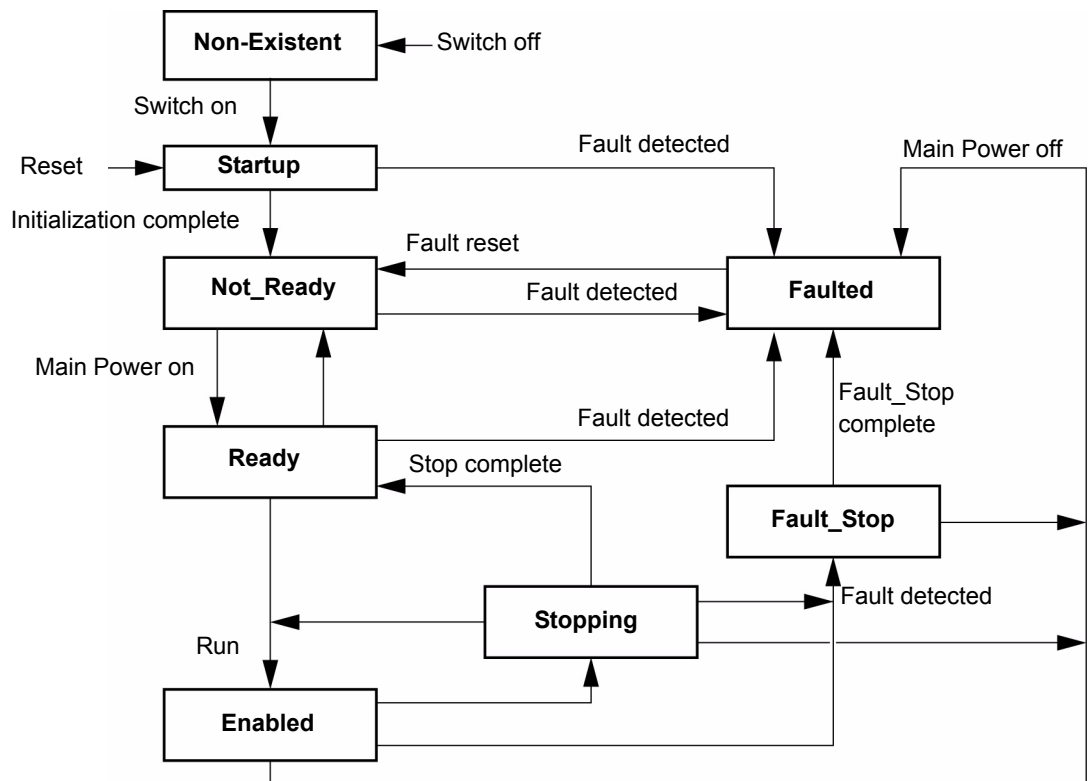

The Servo 3 drive state machine shall be supported as well. This state machine is already defined by D-SW.

Object 2Ahex (AC/DC Drive)**AC/DC Drive**

Path	CIP Name	Altivar Name	CIP Configuration Parameter Name
16#2A/01/07 = 42/1/4	NetRef	-	Requests speed reference to local or from network
16#2A/01/07 = 42/1/7	SpeedActual	Output velocity	Speed Actual
16#2A/01/08 = 42/1/8	SpeedRef	Speed setpoint	Speed Reference
16#2A/01/09 = 42/1/9	CurrentActual	Motor current	Current Actual
16#2A/01/0A = 42/1/10	CurrentLimit	Mot. therm. current	Current Limit
16#2A/01/0B = 42/1/11	TorqueActual	Output torque (Nm)	Torque Actual
16#2A/01/12 = 42/1/18	AccelTime	CIP acceleration time	Acceleration Time
16#2A/01/13 = 42/1/19	DecelTime	CIP deceleration time	Deceleration Time
16#2A/01/14 = 42/1/20	LowSpdLimit	CIP Low speed limit	Low Speed Limit
16#2A/01/15 = 42/1/21	HighSpdLimit	CIP High speed limit	High Speed Limit

Transparent Ready Features



14

What's in this Chapter?

This chapter contains the following topics:

Topic	Page
Presentation	93
Startup Detailed Behavior	94
FDR Operation Behavior	95
FDR Settings	96
Local Configuration	97
Downloaded Configuration	98

Presentation

The FDR (Fast Device Replacement) service is used to simplify the maintenance of drives connected on the Ethernet network. In the event of a drive malfunction, this service automatically reconfigures its replacement.

The new drive (FDR client) retrieves:

- its IP addresses and the FDR file path from a DHCP server
- the FDR file from an FTP server, if the drive is not configured in local configuration

In practice, the DHCP server and the FTP server are the same device (PLCs: TSX Premium, Quantum PLC or dedicated PCs).

The FDR file contains:

- the Ethernet parameters (configuration of I/O scanning, FDR etc.)
- the drive parameters (drive, functions, application, etc.)

The FDR service is based on identification of the device by a "Device Name". In the case of the Altivar 32 drive, this is represented by the **[DEVICE NAME]** (*Pfn*) parameter.

Configuration using the drive graphic display terminal or the integrated display terminal is explained in the "Configuration of the Drive Commands Settings" on page 32. Configuration using the standard Web server is explained in the "Embedded Webserver" on page 100. For configuration using the SoMove software workshop, refer to the software online help.

NOTE: Check that all the network devices do have different "Device Names".

The FDR server controls duplication of "Device Names" (it does not assign an IP address that has already been assigned and is active).

If the same IP address is supplied on 2 devices, the 2nd should trigger an IP address duplication (network management detected fault which leads to a drive detected fault **[External fault com.]** (*EPF2*) by default).

If the FDR service has been enabled, the Ethernet card attempts to restore its IP addresses on each power-up. Each time the procedure detects a fault, the Ethernet card reiterates its FDR requests (DHCP).

Where the configuration also needs to be downloaded by the FDR server:

After assigning the Ethernet card IP addresses, if the configuration download detects a fault, the Ethernet card detects a network management detected fault (which leads to a drive detected fault **[External fault com.]** (*EPF2*) by default).

Startup Detailed Behavior

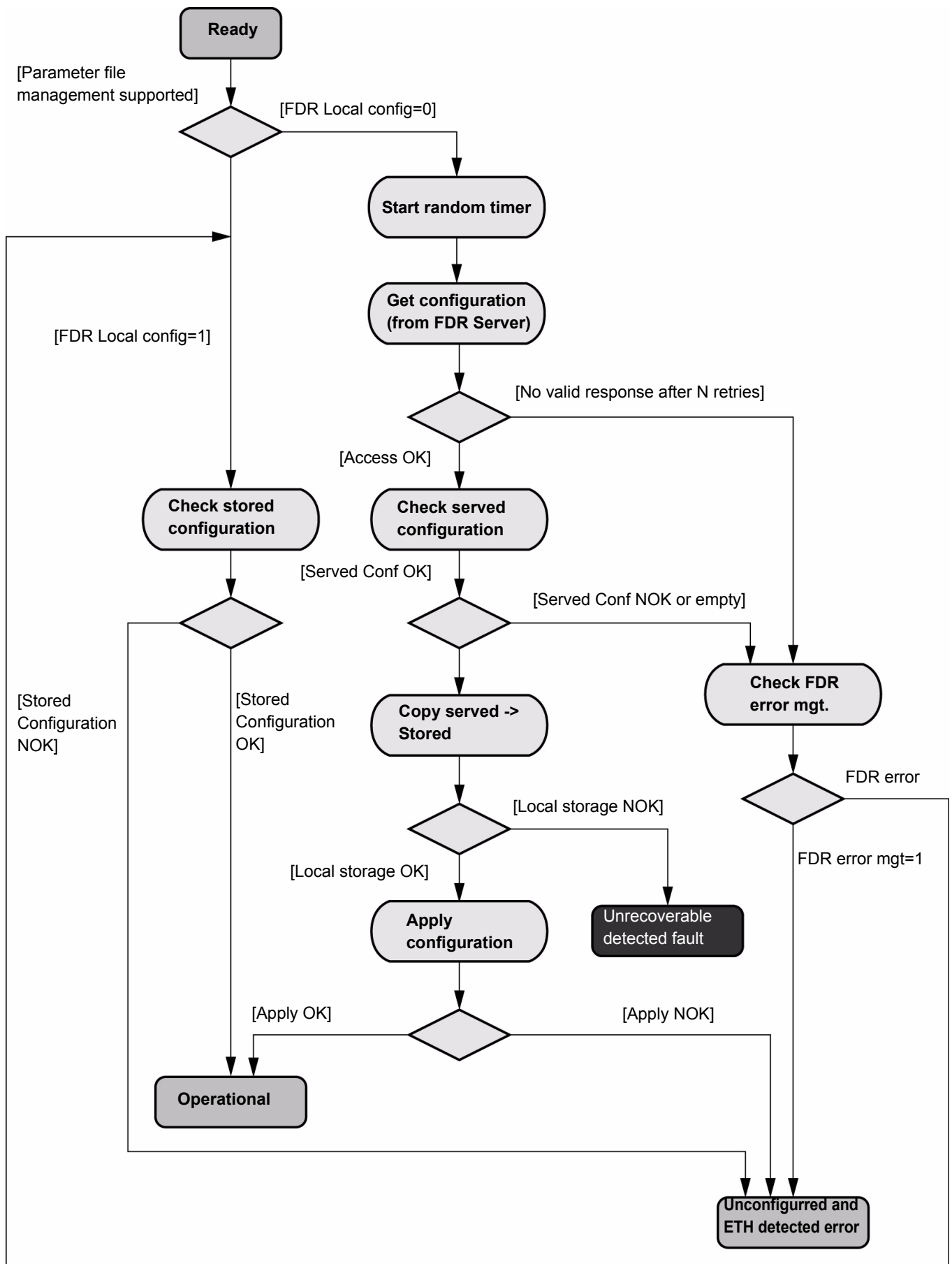

FDR Operation Behavior

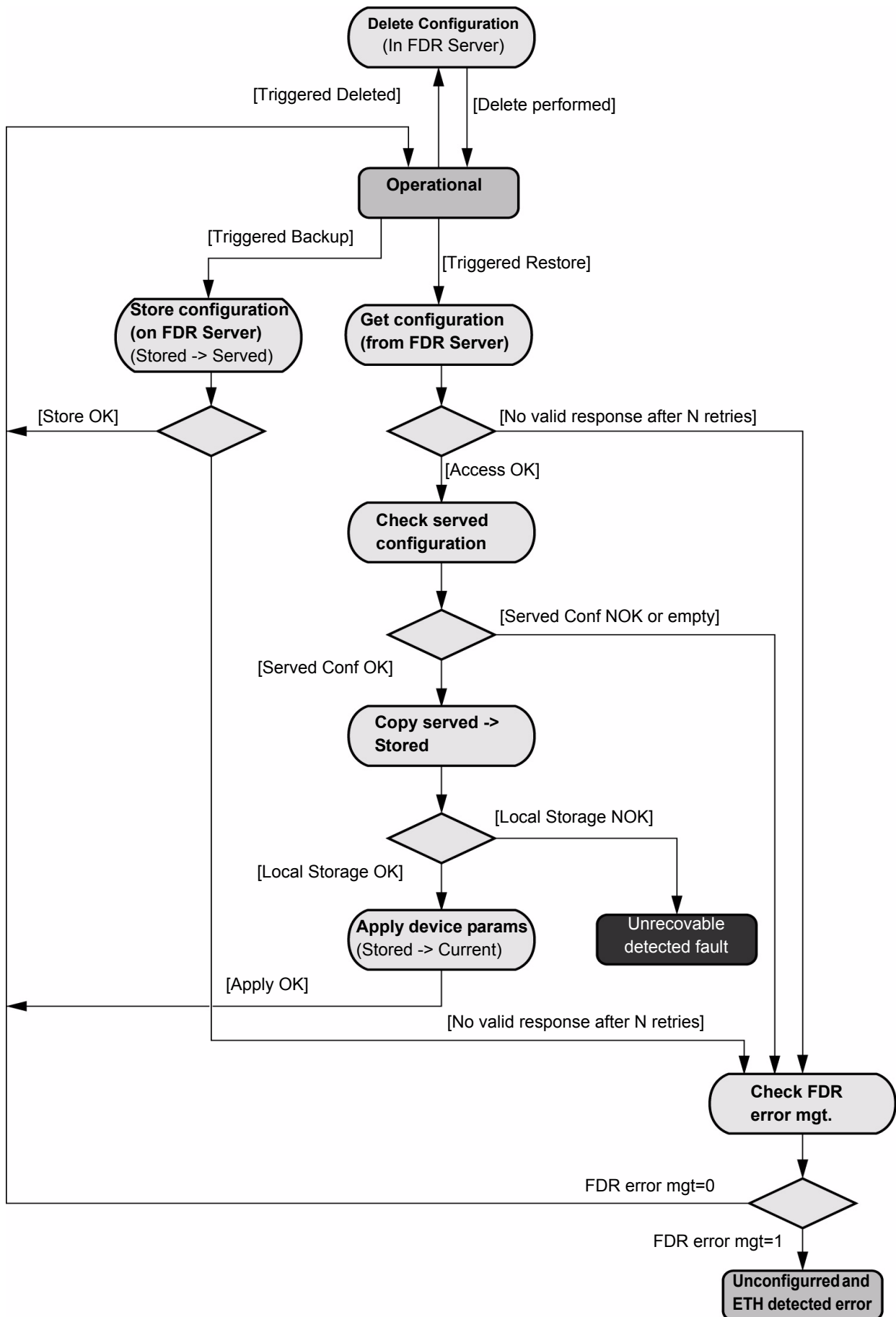

FDR Settings

The following table describes the FDR setting parameters:

Parameter Description (HMI mnemonic)	Range or Listed Values	Default	Long Name	Short Name	Access	Parameter Number
[IP FDR] (<i>IPF -</i>) (<i>IPF 1</i>) (<i>IPF 2</i>) (<i>IPF 3</i>) (<i>IPF 4</i>) These fields displays the served address of the FDR server	0 to 255 for each 4 fields	0.0.0.0	[0.0.0.0]	(<i>0</i>) (<i>0</i>) (<i>0</i>) (<i>0</i>)	R/W	64224 64225 64226 64227
[FDR validation] (<i>Fdr U</i>) Enable FDR service	0: no 1: yes	yes	[No] [Yes]	(<i>n 0</i>) (<i>y e s</i>)	R/W	64228
[Ethernet local conf] (<i>L C F G</i>) Selection of local or server configuration	0: no 1: yes	no	[No] [Yes]	(<i>n 0</i>) (<i>y e s</i>)	R/W	64238
[FDR file error] (<i>Fdr F</i>) Enable FDR detected fault management	0: no 1: yes	yes	[No] [Yes]	(<i>n 0</i>) (<i>y e s</i>)	R/W	64240
[FDR Action] (<i>Fdr R</i>)	IDLE: No command SAVE: save command REST: download command DEL: delete command	IDLE	[IDLE] [SAVE] [REST] [DEL]	(<i>i d l e</i>) (<i>s a v e</i>) (<i>r e s t</i>) (<i>d e l</i>)	R/W	64229
[FDR autosave] (<i>Fdr S</i>) Interval for periodic saving of the FDR service	0: no 1: yes	no	[No] [Yes]	(<i>n 0</i>) (<i>y e s</i>)	R/W	64230
[FDRt. autosave] (<i>Fdr t</i>)	0 to 9999 minutes	0	[0]	(<i>0</i>)	R/W	64231
[FDR state] (<i>Fdr E</i>) FDR service status	- IDLE: idle state - INIT: initialisation - CONF: configuration - RDY: ready - GET: download the current configuration - SET: save the current configuration - APP: Write the FDR server conf. to the drive - OPE: operational - UCFCG: not configured	IDLE	[IDLE] [INIT] [CONF] [RDY] [GET] [SET] [APP] [OPE] [UCFCG]	(<i>i d l e</i>) (<i>i n i t</i>) (<i>c o n f</i>) (<i>r d y</i>) (<i>g e t</i>) (<i>s e t</i>) (<i>a p p</i>) (<i>o p e</i>) (<i>u c f c g</i>)	RW	64232
[FDR Fault] (<i>Fdr d</i>)	- 0: No detected fault - 2: the FDR configuration file is not compatible with the drive type - 3: Detected error reading the FDR configuration file on the server - 4: Detected error writing the configuration file to the server - 7: Time out for receipt of the FDR configuration file from the server - 9: duplicated IP address. - 12: the FDR configuration file is missing - 13: the FDR configuration file deployment on the drive has detected a fault (local detected error) - 14: the configuration file delete request has detected a fault on the FDR server	0	[0] [2] [3] [4] [7] [9] [12] [13] [14]	(<i>0</i>) (<i>2</i>) (<i>3</i>) (<i>4</i>) (<i>7</i>) (<i>9</i>) (<i>1 2</i>) (<i>1 3</i>) (<i>1 4</i>)	R	64233

NOTE: During the application of the configuration, the option use the File Transfer mechanism (FTP) and some system services. If all the transfers are well finished, the operational state is reached. If the configuration is ok: the operational state is reached, else if the configuration is not ok: the unconfigured state is reached (FDR error #14).

Local Configuration

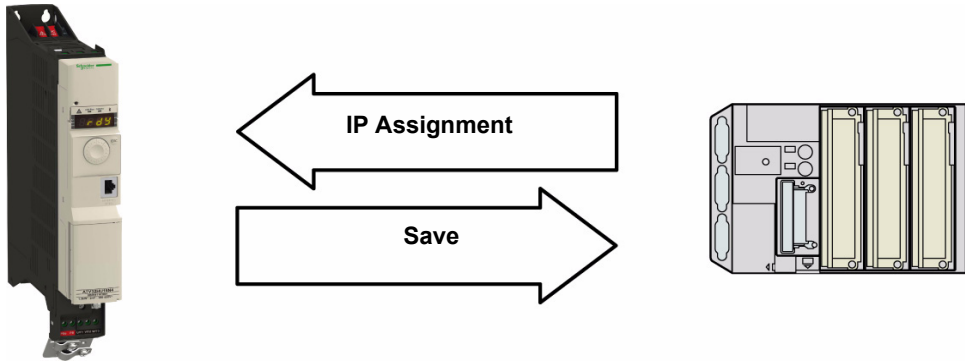

IP Assignment Save

If the drive parameter configuration is local, the FDR server only assigns the following IP addresses:

- Card IP address,
- Subnet mask,
- Gateway IP address.

On connection to the network, the drive automatically saves its parameters in the FDR server.

Drive Connection Procedure

To make the system operational, it is necessary to follow this procedure:

Step	Action
Configure the FDR server	See the PLC manual or the section on software setup using PL7
Configure the drive	In the [COMMUNICATION] (C O N -) menu, [COMMUNICATION CARD] (C b d -) submenu: Configure [IP mode] (I P M) =DHCP Enable the FDR service: [FDR validation] (F d r U) = [Yes] (Y E S) Select local drive configuration: [FDR Local Config.] (L C F G) = [Yes] (Y E S) Enter the device name, [DEVICE NAME] , in the [COMMUNICATION] (C O N -) menu, [COMMUNICATION CARD] (C b d -) submenu
Turn off the drive	Turn the drive off and then back on again (control voltage if a separate power supply is being used), otherwise the device name is not taken into account
Connect the drive to the network	Connect the drive and the FDR server (PLC) to the Ethernet network

Downloaded Configuration

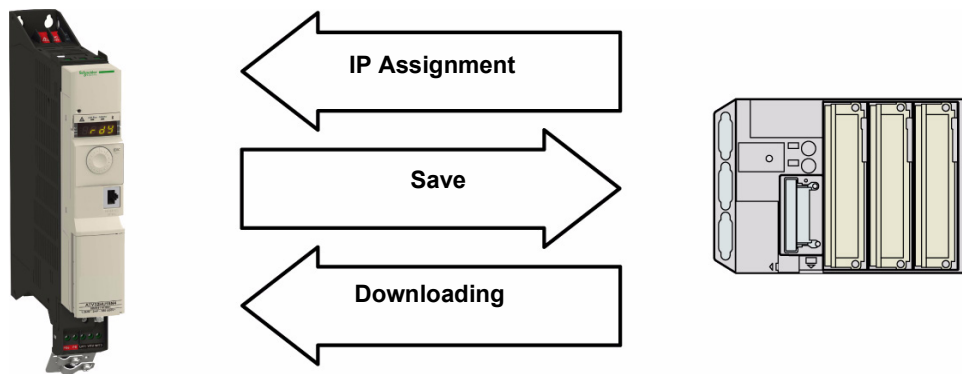

IP Assignment Save

If the drive parameter configuration has been downloaded, the FDR server assigns the following addresses:

- Card IP address,
- Subnet mask,
- Gateway IP address,
- FDR server IP address.

Periodic Saving

Periodic saving of the drive configuration can be configured on the FDR server in either local configuration or downloaded configuration mode.

In the **[COMMUNICATION]** (*C O M -*) menu, **[ETHERNET]** (*E T H -*) submenu,

- Select: **[FDR autosave]** (*F d r S*) = **[Yes]** (*Y E S*).
- Set the **[FDR t.autosave]** (*F d r t*) parameter.

NOTE: Saving too often risks overburdening the network and adversely affecting its performance (factory setting: 10 min).

Other Commands

On request, the configuration saved in the FDR server can be downloaded to the drive using the **[FDR Action]** (*F d r A*) command = **[REST]** (*r E S E*). The saved configuration can be deleted from the FDR server using the **[FDR Action]** (*F d r A*) command = **[DEL]** (*d E L*).

Configuration File

The configuration file, XXXX.prm where XXXX is the DeviceName, is an HTML file which contains the entire drive configuration as a comment. The HTML format is a simple way of providing the user with a summary of the configuration. An example appears below:

```
FDR Configuration File
File Revision: 2
ATV Revision: 1.0IE1.0
Catalog number: ATV-32HU15M3
Checksum File: SE92
```

Limitations

The FDR service is able to store the current configuration of the drive, but does not provide the possibility to store multi-configurations or multi-parameters configurations.

Drive Parameters (Configuration)

In the procedure described below, the configuration file is supplied to the FDR server, via the Ethernet network, using a save command performed on the drive graphic display terminal.

NOTE: This procedure can also be performed using a Web browser, which is more user-friendly than the drive graphic display terminal (see “Embedded Webserver” on page 100).

For the first use, it is necessary to follow the procedure below:

Step	Action
Configure the drive	<p>In the [COMMUNICATION] (C O N -) menu, [ETHERNET] (E t H -) submenu:</p> <ul style="list-style-type: none"> • Leave the IP address [IP card] (I P C 1) (I P C 2) (I P C 3) (I P C 4) at the value [0.0.0.0] (0) (0) (0) (0) • Enable the FDR service: [FDR validation] (F d r U) = [Yes] (Y E S) • Caution, before the first connection, you must select local drive configuration: [FDR Local Config.] (L C F G) = [Yes] (Y E S). The drive must first supply the configuration to the server. <p>Enter the device name, [DEVICE NAME], in the [DISPLAY CONFIG.] menu, [USER PARAMETERS] submenu. This menu can only be accessed in expert mode: In the [ACCESS LEVEL] (L A C -) menu, set the level to [expert] (E P r)</p>
Turn off the drive	Turn the drive off and then back on again (control voltage if a separate power supply is being used), otherwise the device name is not taken into account
Connect the drive to the network	Connect the drive and the FDR server (PLC) to the Ethernet network
Configure the FDR server (see the PLC manual)	<p>The server downloads the IP addresses to the Ethernet card.</p> <p>Check that the operation has proceeded correctly: you can also check, in the [COMMUNICATION] (C O N -) menu, [ETHERNET] (E t H -) submenu whether the [IP card] (I P C 1) (I P C 2) (I P C 3) (I P C 4), [IP Mask] (I P M 1) (I P M 2) (I P M 3) (I P M 4) and [IP Gate] (I P G 1) (I P G 2) (I P G 3) (I P G 4) parameters have values other than [0.0.0.0] (0) (0) (0) (0)</p>
Supply the FDR server with the configuration file	<p>Configure the drive parameters.</p> <p>In the [COMMUNICATION] (C O N -) menu, [ETHERNET] (E t H -) submenu:</p> <p>Specify that the drive configuration is to be downloaded from the FDR server on each power-up: [FDR Local Config.] (L C F G) = [No] (n O).</p> <p>Send a save command to the FDR server: [FDR Action] (F d r A) = [SAVE] (S A V E).</p> <p>After execution of the command, the [FDR Action] (F d r A) parameter reverts to the value [IDLE] (I d L E)</p>
Check that the system is operational	<p>Check that the operation has proceeded correctly: the [FDR state] (F d r E) parameter should be at the value [OPE] (O P E)</p> <p>If the save operation has not been successful, the card detects a communication (network management) detected fault which, in factory settings mode, triggers a drive detected fault [External fault com.] (E P F 2)</p>

Replacing a Drive

For replace a drive, it is necessary to follow the procedure below:

Step	Action
Configure the drive	<p>In the [COMMUNICATION] (C O N -) menu, [ETHERNET] (E t H -) submenu:</p> <ul style="list-style-type: none"> • Leave the IP address [IP card] (I P C 1) (I P C 2) (I P C 3) (I P C 4) at the value [0.0.0.0] (0) (0) (0) (0) • Enable the FDR service: [FDR validation] (F d r U) = [Yes] (Y E S) • Specify that the drive configuration is to be downloaded from the FDR server on each power-up: [FDR Local Config.] (L C F G) = [No] (n O). <p>These configurations are the default values</p> <p>Enter the device name, [DEVICE NAME], in the [DISPLAY CONFIG.] menu, [USER PARAMETERS] submenu. This menu can only be accessed in expert mode: In the [ACCESS LEVEL] (L A C -) menu, set the level to [expert] (E P r)</p>
Turn off the drive	Turn the drive off and then back on again (control voltage if a separate power supply is being used), otherwise the device name is not taken into account
Connect the drive to the network	Connect the drive and the FDR server (PLC) to the Ethernet network
Check that the drive is operational	<p>Check that the operation has proceeded correctly:</p> <ul style="list-style-type: none"> • The "STS" LED should be on • The [FDR state] (F d r E) parameter should be at the value [OPE] (O P E) <p>If downloading has not been possible after a period of 2 min following assignment of the IP addresses, the card detects a communication (network management) detected fault which, in factory settings mode, triggers a drive detected fault [External fault com.] (E P F 2)</p>

Embedded Webserver

**15**

What's in this Chapter?

This chapter contains the following topics:

Topic	Page
Overview	101
Connexion to the Webserver	101
Pages Description	102
FTP Server	111

Overview

The VW3 A3 616 provides an integrated web server which allows several function like: monitoring, parameter settings and diagnostics. This chapter describes the services provided by this webserver.

The webserver can be accessed from standard Browsers like Internet Explorer or Firefox.

Connexion to the Webserver

The webserver can be accessed from standard browsers like Internet Explorer or Firefox.

In the following example, the ATV32 has received the IP address 10.0.0.5:



First connect the PLC to the ATV32 by typing `http://` followed by the ATV32 IP address.

You will be asked to first enter a User Name and a password.

By default the user name is USER and the password is also USER.

Once connected, the webserver home page is displayed.

Access Rights - Password and User Names

Before stating the description of the different topics of the server, you should notice that:

- “Web read password”: Access to the different pages requires a User access level. This is the first level of password, you can monitor and access to all the pages of the webserver, but not modify data.
 - User name: USER (default value)
 - Password: USER (default value)
- “Web write password”: Access to data or settings change, an Administrator access level is required.
 - Password: USER (default value).

The user names and the password of both level can be modified from the administration section (> homer > Network Setup > Administration).

Web Server Site Map

Home	Monitoring	Altivar viewer Drive parameters
	Network settings	Modbus TCP - I/O scanner configuration Ethernet/IP - I/O scanner configuration Fast device replacement Administration
	Diagnostics	TCP/IP statistics CIP and Ethernet/IP statistics

Pages Description

Home Page



The home page or “Home” menu contain the following item:
A “**Languages**” submenu containing a link to the “English” page.

The only link in the “Languages” submenu sends the user to the home page in English and configures the Web browser to open the HTML pages located in the corresponding directory.

(example: the “http://139.160.69.241/html/english/” directory becomes the standard directory in the case of English).

Note About Java Applets

The Webserver downloads Java programs called “applets” to your computer. These applets communicate with the drive using Modbus services (on port 502), thus establishing one or more connections between the computer and the drive. Until an applet has been fully transmitted from the drive to the browser, a gray rectangle appears in the place reserved for it in the page.

The applets associated with the Web pages monitor communication with the drive. When the drive no longer responds to requests to update the data, the message “Link down” is displayed in one field and all the other field contents are emptied.

Subsequently, the description of each page indicates the data refresh period requested by the applet loaded on the computer. The refresh period actually observed depends on:

- The performance of the computer on which the Web browser is running,
- The communication system response time,
- The amount of data to be refreshed on the page.

Monitoring Menu

The “Monitoring” menu contains the two following items:

- A link to the “**Altivar viewer**” page:

The screenshot shows the Schneider Electric ATV32 web interface. The top navigation bar includes 'Home' and 'Documentation...'. The main content area is titled 'Monitoring' and contains the following data:

- Device name:** P
- Altivar status:** RDY
- Device ref.:** (empty field)

Terminal status indicators are shown as follows:

L11	R1	AI1	10.0
L12	R2	AI2	-0.256
L13	LO1	AI3	0.0070
L14		AO1	0.0
L15			
L16			

A table of drive parameters is displayed:

FRH Freq. Ref.	Hz	50.0
RFR Output Freq.	Hz	0.0
OTR Output Torque	%	0.0
ULN Mains Voltage	V	223.2
UOP Motor Voltage	V	0
LCR Motor Current	A	0.0
THD Drive Thermal	%	17
THR1 Motor Thermal	%	0
OPR Output Power	%	0
APH Power Used	kWh	0.0
RTH Run Time	h	0.0

A 'Motor Speed (RPM)' gauge is shown with a scale from -3600 to 3600. The needle is positioned at 0 RPM.

Copyright © 1998 - 2010, Schneider Electric. All Rights Reserved.

The state indicated in the “Altivar State” field corresponds to the display on the drive integrated display terminal. A delay may sometimes be noticed between the displays on the Web server and the display terminal, depending on the performance of the computer used to display the pages using a Web browser and the communication system performance.

The motor speed displayed on the “Motor Speed” gauge is calibrated according to the maximum frequency **[Max frequency] (L F r)** and the number of pairs of poles **[Pr] (P P n)**.

The LI... area gives the state of the drive terminals (logic inputs LI1 to LI16, logic outputs LO1, relay outputs R1 to R2, analog inputs AI1 to AI3 and analog output AO1). When a logic input is active, the LED is green. When a logic output is active, the LED is red.

- A link to the “Drive parameters” page:

Schneider Electric **ATV32**
 Home Documentation...
 Monitoring Network Setup Diagnostics

Drive parameters

Rate 1000 IP address 192.168.0.1

Parameter	Address	UnitId	Description	Value	Unit
RPT	9004	0	Ramp type	0	
INR	9020	0	Ramp increment	1	
ACC	9001	0	Acceleration	31	
DEC	9002	0	Deceleration	30	
TA1	9005	0	Begin Acc round	10	%
TA2	9006	0	End Acc round	10	%
TA3	9007	0	Begin Dec round	10	%
TA4	9008	0	End Dec round	10	%
FRT	9011	0	Ramp 2 threshold	0.0	Hz
RP5	9010	0	Ramp switch assignment	0	
AC2	9012	0	Acceleration 2	50	
DE2	9013	0	Deceleration 2	50	
BRA	9003	0	Dec ramp adapt.	1	

40ms 30ms 90ms

This page is used to display the drive parameters and to modify their values.

The parameters are arranged in groups, and are consistent with the keypad and user manuals.

The display mode for each value depends on the nature of the parameter:

- The unit for the physical values is displayed in the “Unit” column.
- The registers (bit fields) are displayed in hexadecimal format (16#xxxx).
- Signed values are displayed as such.

To begin the monitoring, click on the “Start animation” button:

To modify the parameter value, click on the “Write value of selected row” button then select the parameter to modify.

It is only possible to modify the parameter values after entering the “Write password” (see “Access Rights - Password and User Names” on page 101). Click on the “Password” button to enter this password. An entry field then appears in the parameter table, and also a “Cancel” button, for cancelling the password entry. After entering the password, press the Enter key so that it is taken into account by the Web browser.

When the value of a parameter cannot be modified, the following warning appears: “This parameter can’t be written!”.

This is the case for all parameters until you have correctly entered the Password.

If I/O Scanning has been enabled, modifying the value of a parameter assigned to periodic output variables will have no effect since this value is updated cyclically by the PLC. The same applies if a parameter is written periodically by a Modbus service.

Network Parameters

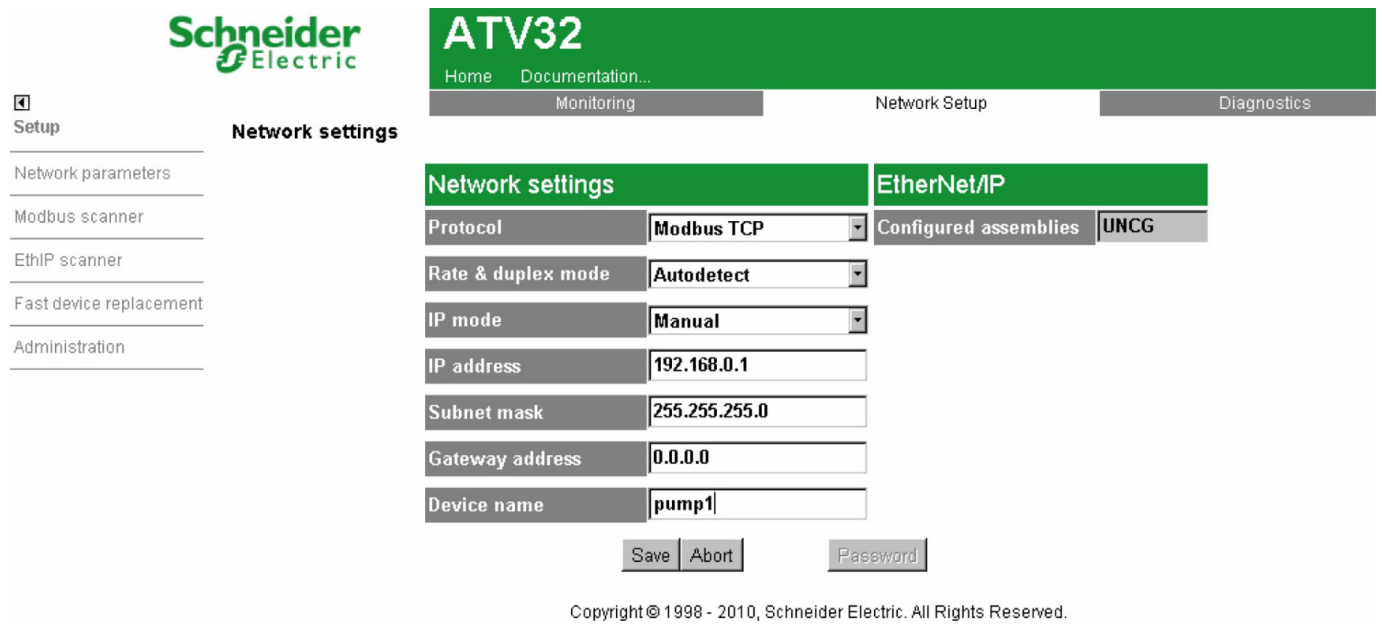

ATV32
Home Documentation...

Monitoring Network Setup Diagnostics

Network settings

EtherNet/IP

Protocol **Modbus TCP** Configured assemblies **UNCG**

Rate & duplex mode **Autodetect**

IP mode **Manual**

IP address **192.168.0.1**

Subnet mask **255.255.255.0**

Gateway address **0.0.0.0**

Device name **pump1**

Save Abort Password

Copyright © 1998 - 2010, Schneider Electric. All Rights Reserved.

Modbus Scanner

This page is used to:

- Enable or disable I/O Scanning.
- Display and modify assignment of the I/O Scanning periodic variables.
- Set the communication monitoring time out.

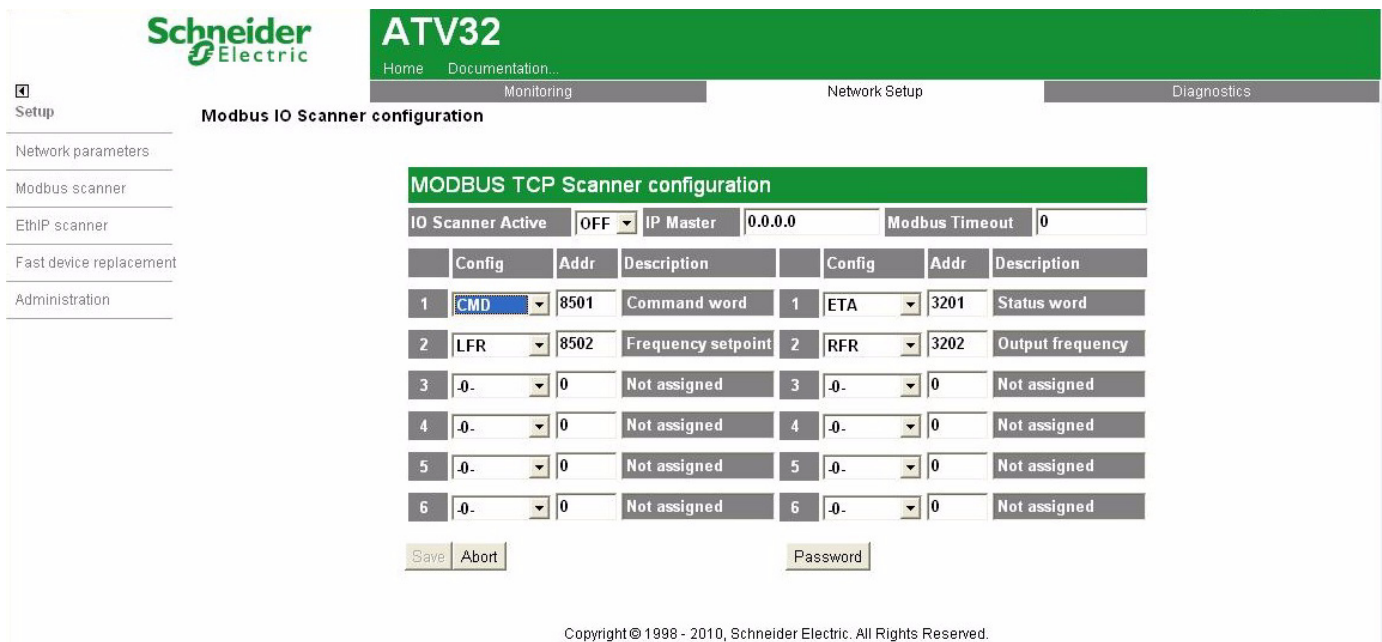

ATV32
Home Documentation...

Monitoring Network Setup Diagnostics

Modbus IO Scanner configuration

MODBUS TCP Scanner configuration

IO Scanner Active **OFF** IP Master **0.0.0.0** Modbus Timeout **0**

	Config	Addr	Description		Config	Addr	Description
1	CMD	8501	Command word	1	ETA	3201	Status word
2	LFR	8502	Frequency setpoint	2	RFR	3202	Output frequency
3	.0.	0	Not assigned	3	.0.	0	Not assigned
4	.0.	0	Not assigned	4	.0.	0	Not assigned
5	.0.	0	Not assigned	5	.0.	0	Not assigned
6	.0.	0	Not assigned	6	.0.	0	Not assigned

Save Abort Password

Copyright © 1998 - 2010, Schneider Electric. All Rights Reserved.

All modifications are protected by the “Write password” modification password.

Click on the “PassWord” button to enter the “Write password”.

After correctly entering the password, you can access “I/O scanner”, “Time Out (s)”, “Master”, “Output parameters”, “Input parameters” and the “Save” and “Abort” buttons.

By default, the password is “USER”. It can be modified in the “Data write password” page.

Enabling I/O Scanning

Control by the I/O scanner is enabled if the “I/O scanner” field is at the value “Yes” and is disabled by the value “No”. The “I/O scanner” field corresponds to the parameter **[IO Scan.activ.] (I O S R)**.

NOTE: Disabling I/O Scanning results in loss of control if a PLC is using an I/O scanner.

Before disabling I/O Scanning, you must disable the time out (set the value to 0). However, communication monitoring remains active and the card triggers a communication detected fault at the end of the period defined by the time out. In factory settings mode, the drive then changes to **[Com. network] (C n F)** detected fault mode.

Once the value in the “I/O scanner” field has been modified, it may take a while to update the page, depending on the capacity of your computer.

The “I/O scanner” field corresponds to the parameter **[IO Scan.activ.] (I O S A)**.

Assigning the I/O Scanning periodic variables

NOTE: Modifying the assignment of the periodic variables can result in loss of control if a PLC is using an I/O scanner.

To modify the I/O Scanning periodic variables, proceed as follows:

- Enter “No” in the “I/O scanner” field.
- Modify the assignment of periodic variables.
- Apply these modifications using the “Save” button.
- Enter “Yes” in the “I/O scanner” field.

Once the value in the “I/O scanner” field has been set to “No”, it may take a while to update the page, depending on the capacity of your computer. A dropdown menu is used to modify the assignment of each of the periodic variables.

Click on the periodic variable whose assignment you wish to modify, then choose the code corresponding to the drive parameter to be assigned. The parameter can be chosen from the drop down list or directly entered with its Modbus address.

All modifications to “Output parameters” and/or “Input parameters” can be confirmed by clicking on the “Save” button or canceled by clicking the “Abort” button.

Each time the “Save” button is pressed, the address table will be saved to an EEPROM on the Ethernet card. The assignments are now saved, even if the power is turned off.

Modbus IO Scanner configuration

MODBUS TCP Scanner configuration

IO Scanner Active: OFF | IP Master: 0.0.0.0 | Modbus Timeout: 20

	Config	Addr	Description		Config	Addr	Description
1	CMD	8501	Command word	1	ETA	3201	Status word
2	LFRD	8602	Speed setpoint	2	RFRD	8604	Output velocity
3	0-	0	Not assigned	3	0-	0	Not assigned
4	0-	0	Not assigned	4	0-	0	Not assigned
5	0-	0	Not assigned	5	0-	0	Not assigned
6	0-	0	Not assigned	6	0-	0	Not assigned

Buttons: Save, Abort, Password

Copyright © 1998 - 2010, Schneider Electric. All Rights Reserved.

Master

To configure reservation, enter an IP address other than **[0.0.0.0]** in the “Master” field. This field is equivalent to the **[IP Master] (I P P -)** parameter.

Time out

This page can also be used to modify the communication monitoring “time out”. All entries must be confirmed by pressing “Enter”.

The accepted values are as follows:

- 0: No communication check.
- 0.5 to 60.0 s: Time out value.

See “Configuring Communication Detected Fault Management” on page 42. The default time out value is 2 s (display: “2.0”).

The “Time Out” field corresponds to the **[time out] (E O U E)** parameter.

EtherNet/IP Scanner

The screenshot shows the 'EtherNet/IP Scanner configuration' page for an ATV32 drive. The interface includes a navigation menu on the left with options like 'Setup', 'Network parameters', 'Modbus scanner', 'EtherIP scanner', 'Fast device replacement', and 'Administration'. The main content area features a table for configuring periodic variables for two assemblies (100 and 101). The table has columns for 'Config', 'Addr', and 'Description'. Assembly 100 has variables 1 through 6, with variable 1 set to 'CMD' at address 8501 (Command word) and variable 2 set to 'LFR' at address 8502 (Frequency setpoint). Assembly 101 has variables 1 through 6, with variable 1 set to 'ETA' at address 3201 (Status word) and variable 2 set to 'RFR' at address 3202 (Output frequency). All other variables are set to 'Not assigned'. Below the table are 'Save', 'Abort', and 'Password' buttons. The footer contains the copyright notice: 'Copyright © 1998 - 2010, Schneider Electric. All Rights Reserved.'

A dropdown menu is used to modify the assignment of each of the periodic variables.

Click on the periodic variable whose assignment you wish to modify, then choose the code corresponding to the drive parameter to be assigned.

The parameter can be chosen from the drop down list or directly entered with its Modbus address.

All modifications to “Output parameters” and/or “Input parameters” can be confirmed by clicking on the “Save” button or canceled by clicking on the “Abort” button.

NOTE: These modifications will be taken into account when the power is switched off /on.

Each time the “Save” button is pressed the address table will be saved to an EEPROM on the Ethernet card. The assignments are now saved, even if the power is turned off.

Fast Device Replacement

This page displays the main parameters used by the VW3 A3 616 Ethernet card FDR function and is used to configure these parameters. See the "FDR Service" chapter in this section for more information.

The screenshot shows the Schneider Electric ATV32 web interface. The top navigation bar includes 'Home', 'Documentation...', 'Monitoring', 'Network Setup', and 'Diagnostics'. The main content area is titled 'Fast device replacement' and contains two columns of configuration parameters:

FDR configuration		FDR status	
FDR Server	0.0.0.0	Device Name	Pump1
FDR State	3: Ready	Device File	/003011ff013d.xml
FDR Validation	OFF	Device Reference	
Local Config	OFF	IP Address	10.0.0.6
FDR Error mgt.	OFF	Net Mask	255.255.255.0
Autosave	OFF	Gateway	10.0.0.1
Period (minute)	0	Error Code	0: No fault
		Save Counter	0
		Restore Counter	0
		Delete Counter	0

Below the configuration table are buttons for 'Save' and 'Restore'. At the bottom of the configuration area are buttons for 'Save file', 'Restore file', 'Delete file', 'Counters reset', and 'Password'.

Copyright © 1998 - 2010, Schneider Electric. All Rights Reserved.

Administration

This page is used to modify the Web read and the web write password. See "Access Rights - Password and User Names" on page 101.

The screenshot shows the Schneider Electric ATV32 web interface for the 'Administration' page. The top navigation bar is the same as in the previous screenshot. The main content area is titled 'Administration' and contains two password input fields:

Web read password [] Save

Web write password [] Save

Below the password fields are buttons for 'Abort' and 'Password'.

Copyright © 1998 - 2010, Schneider Electric. All Rights Reserved.

TCP/IP Statistics

This page gives detailed information about the Ethernet status and settings.

The screenshot shows the Schneider Electric ATV32 web interface. The top navigation bar includes 'Home' and 'Documentation...'. Below it are tabs for 'Monitoring', 'Network Setup', and 'Diagnostics'. The left sidebar contains a tree view with 'Diagnostics' expanded, showing 'TCP/IP statistics', 'Modbus statistics', and 'Ethernet IP statistics'. The main content area is titled 'Ethernet and TCP/IP statistics' and contains several tables and a 'Reset counters' button.

TCP/IP parameters		Status	
IP Address	10.0.0.6	Link Status (right/B port)	Link down
Subnet mask	255.255.255.0	Link Status (left/A port)	100BaseTX-FD
Default gateway	10.0.0.1	Receive statistics	
IP Mode	DHCP	Frames received OK	4334
Ethernet parameters		CRC errors	0
MAC Address	00-30-11-FF-01-3D	Transmit statistics	
Ethernet frame format	Ethernet II	Frames transmitted OK	4828
Data rate (right/B port)	Link down	Collisions	0
Data rate (left/A port)	100 Mbps	Carrier sense errors	0
		Excessive collisions	0
		Late collisions	0

Copyright © 1998 - 2010, Schneider Electric. All Rights Reserved.

Modbus Messaging Statistics

This page gives detailed information about the Modbus server.

The screenshot shows the Schneider Electric ATV32 web interface for Modbus Messaging statistics. The layout is similar to the previous page, with the 'Diagnostics' menu expanded to 'Modbus statistics'. The main content area is titled 'Modbus Messaging statistics' and contains two tables and a 'Reset counters' button.

Inbound / Outbound statistics		IO Scanner statistics	
Opened TCP connections	1	IO scans received	0
Sent Modbus msg	2914	IO scans transmitted	0
Received Modbus msg	2914	Error messages	0
		IO scan errors	0

Copyright © 1998 - 2010, Schneider Electric. All Rights Reserved.

EtherNet/IP Statistics

This page gives detailed information about the status and the CIP* settings.



ATV32

Home Documentation...

Monitoring
Network Setup
Diagnostics

Diagnostics

TCP/IP statistics

Modbus statistics

Ethernet IP statistics

Ethernet IP statistics

Connection diagnostic		Explicit Messaging diagnostic	
Max CIP IO Connections opened	0	Class3 Msg Send Counter	0
Current CIP IO Connections	0	Class3 Msg Receive Counter	0
Max CIP Exp Connections opened	0	UCMM Msg Send Counter	0
Current CIP Exp Connections	0	UCMM Msg Receive Counter	0
CIP Connection Opening Errors	0	Bandwidth diagnostic	
CIP Connection Timeout Errors	0	Current sending Urgent prio rate (pkt/s)	0
Max EIP TCP Connections opened	0	Current reception Urgent prio rate (pkt/s)	0
Current EIP TCP Connections	0	Current sending Scheduled prio rate (pkt/s)	0
IO Messaging diagnostic		Current reception Scheduled prio rate (pkt/s)	0
IO Production Counter	0	Current sending High prio rate (pkt/s)	0
IO Consumption Counter	0	Current reception High prio rate (pkt/s)	0
IO Production Send Errors Counter	0	Current sending Low prio rate (pkt/s)	0
IO Consumption Receive Errors Counter	0	Current reception Low prio rate (pkt/s)	0
		Current sending Explicit rate (pkt/s)	0
		Current reception Explicit rate (pkt/s)	0

Copyright © 1998 - 2010, Schneider Electric. All Rights Reserved.

CIP: Common Industrial Protocol

FTP Server

Access

- Access the embedded Web server resource files.
- Store the FDR (Faulty Device Replacement) service configuration files.

Access to the FTP server is protected. To access it, the user has to enter a user name and a password:

- The user name is USER.
- The default HTTP password is USER. It can be changed by the standard Web server.

Address format in Internet Explorer: **ftp://USER:USER@xxx.xxx.xxx.xx**

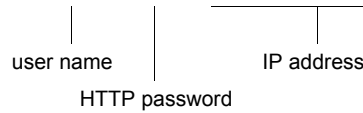

Restrictions:

- The “FDR” folder is “fixed” and cannot be removed.
- The file names can be up to 48 characters long (maximum).

SNMP Agent

The VW3 A3 616 is compliant with SNMP V1.0.

Supported Functions

Objects	Description	Access	Default Value
SysDescr	Text description of the product	RO	Schneider Electric Altivar Fast Ethernet TCP/IP Module
SysObjectID	Points in the private MIB on the product reference	RO	1.3.6.1.4.1.3833.1.7.255.6
SysUpTime	Time elapsed since the last power up	RO	Managed by the option
SysContact	Information allowing to contact the node manager	R/W	" "
SysName	Node administrative name	R/W	“ATV” or FDR device name if configured
SysLocation	Physical location of the product	R/W	" "
SysService	Indicates the service type offered by the product.	RO	72

Remark

- The VW3 A3 616 manages the following PDU: GET, GetNext, Set. it does not manage the PDU “TRAP”.
- A SET with a too big size generates a standard detected error named: “tooBit (1)”
- Trying to access other objects must return “noSuchName (2)”,

Integration in the EtherNet/IP Network

16

What's in this Chapter?

This chapter contains the following topics:

Topic	Page
Installing the EDS File	113
Configuration of the EtherNet/IP Module in the Rockwell PLC	115
Configuring the Implicit Exchanges	116
Configuration of the Communication Scanner	118
Configuration of the Communication Period	119
Explicit Messaging	120
Assembly Selection	122

Installing the EDS File

The EDS file of the VW3 A3 616 communication card can be downloaded from Schneider-electric.com. To install the new EDS file, you can launch the EDS wizard from the Tools entry of RS-Networx menu.

Select “register an EDS file”:

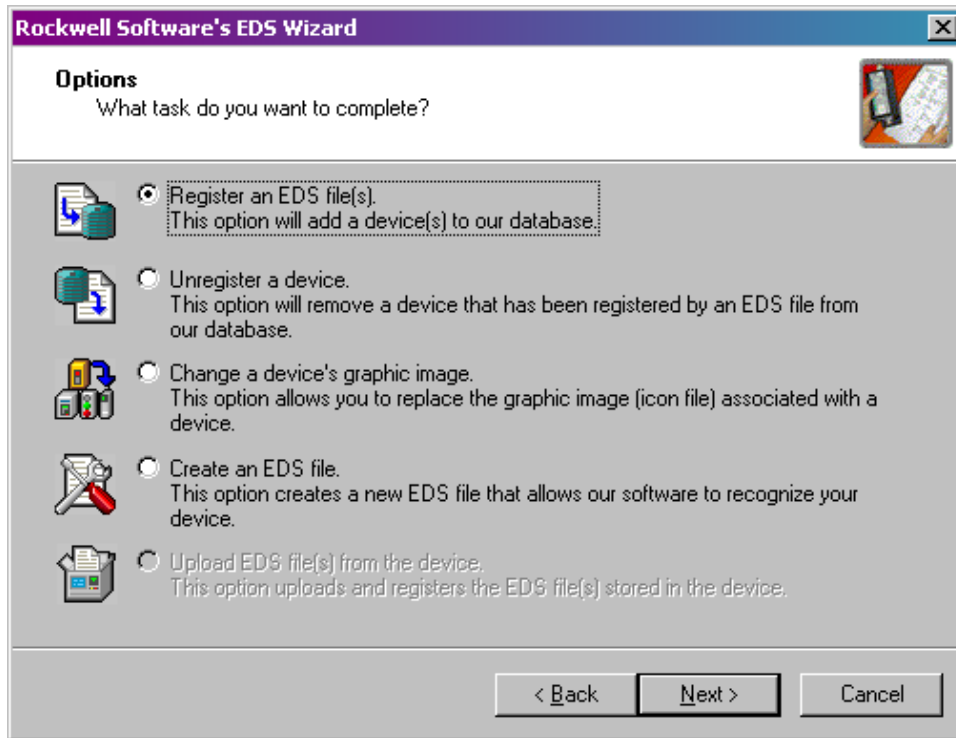

Click “Next” button.

Select the location where the EDS file has been recorded:

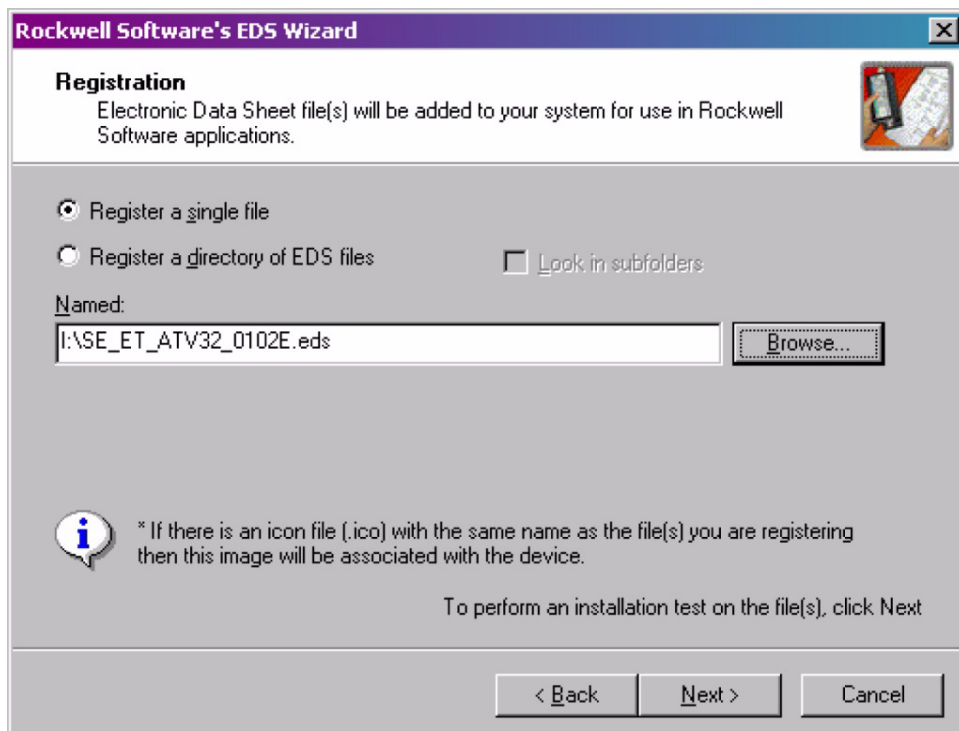

Click “Next” button.

You should get the following result, that indicates that the EDS file has been successfully imported:

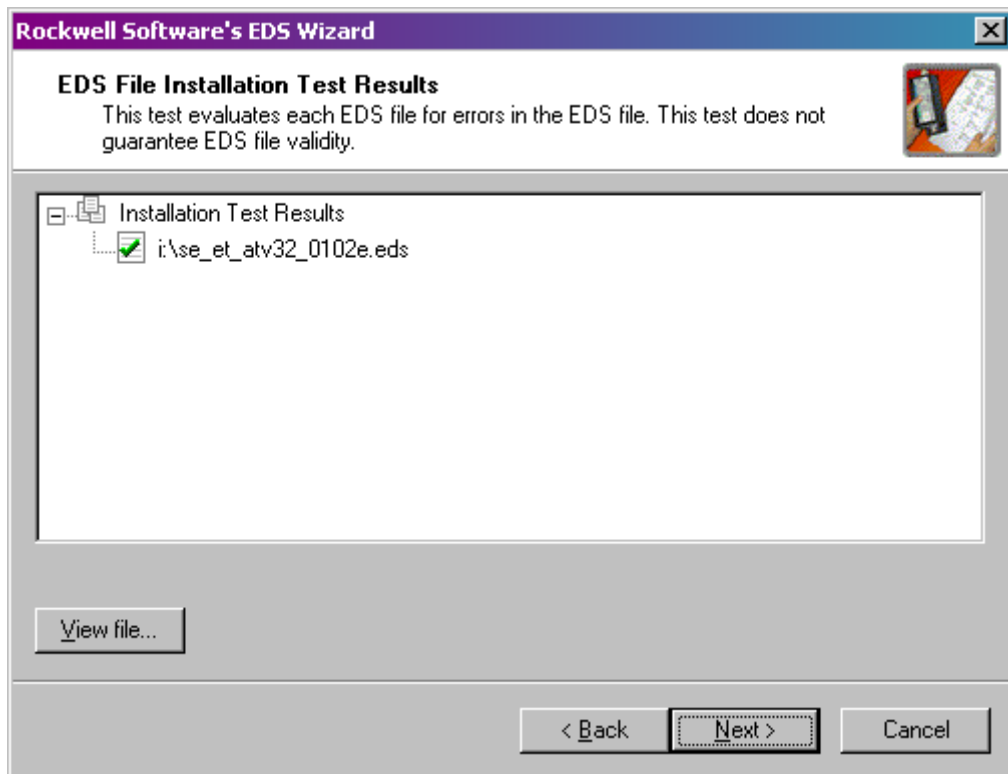

Click "Next" button.

When selecting "Next" the wizard will propose you to change the icon picture associated to the device. If you don't need to change the icon file click "Next" button to terminate the EDS registration.

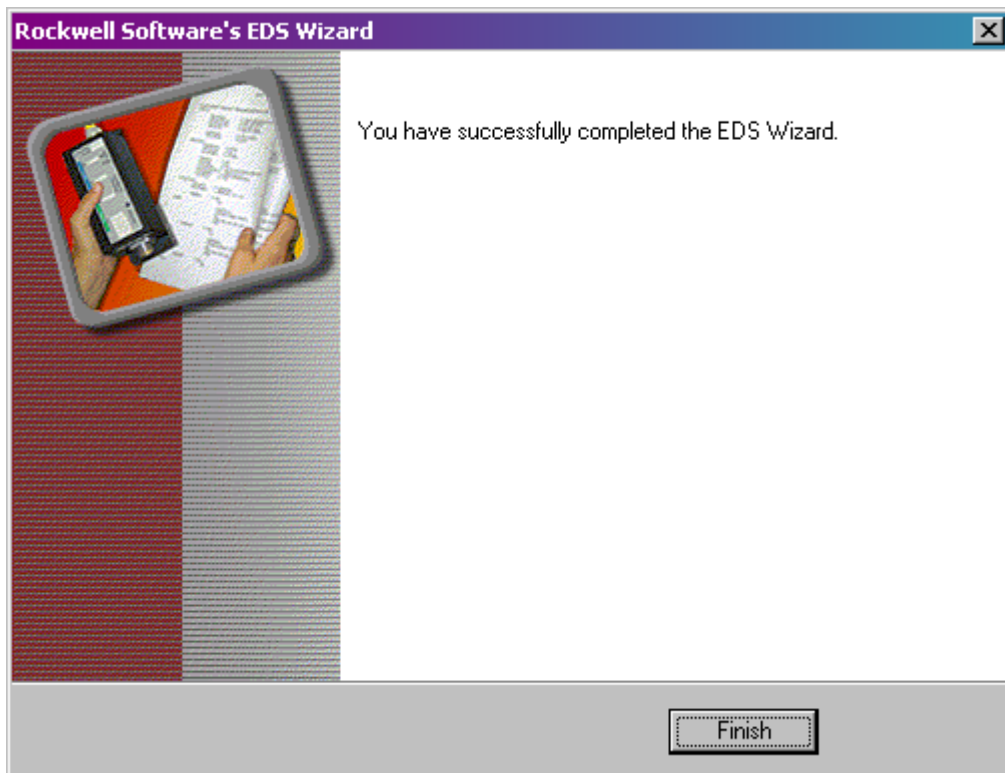

Configuration of the EtherNet/IP Module in the Rockwell PLC

In the example below, the module is installed in the first slot of the local base plate of a 1756 CPU:

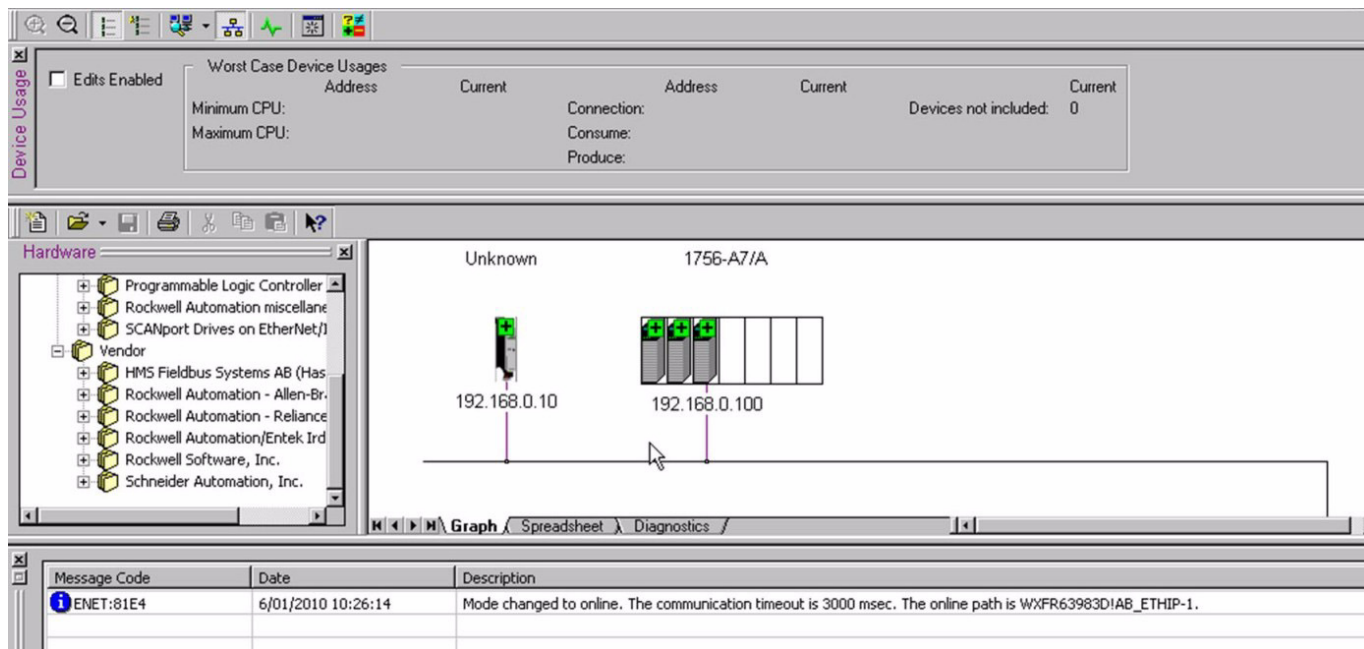

The VW3 A3 616 module is identified with the symbol: Generic Module. This identifier will be used later with tools such as the Class Instance editor.

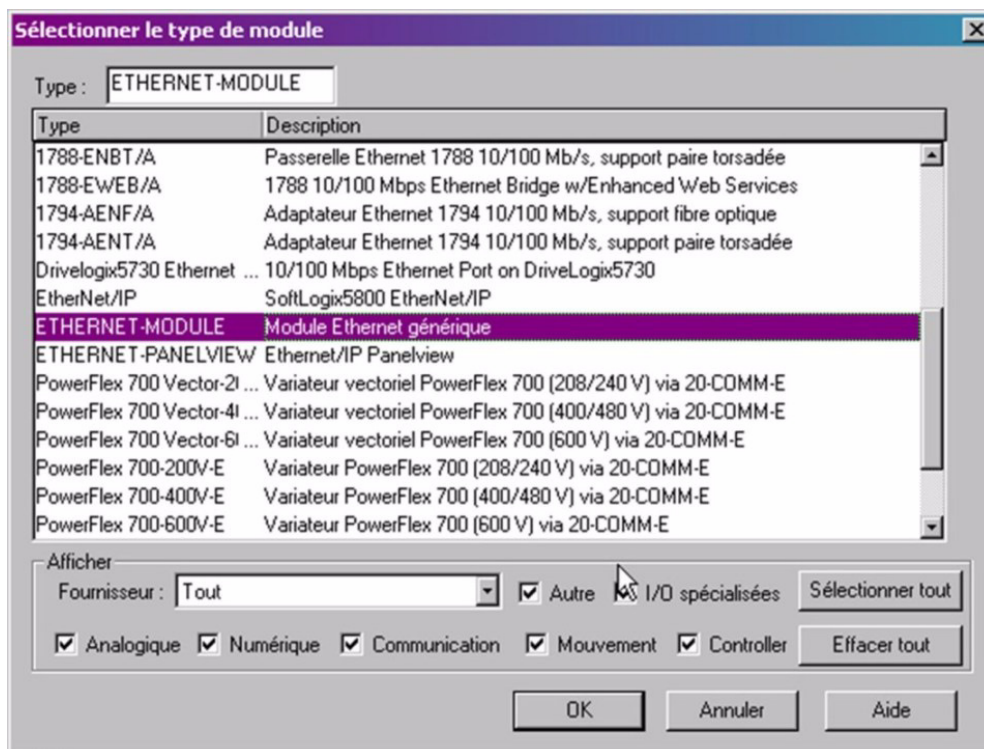

Configuring the Implicit Exchanges

The ATV32 allows the use of 3 assemblies set as described in previous chapter. In the example we have selected the assemblies 100 and 101 are relative to the ATV32 native Profile (CiA402 velocity mode).

	Instance de groupe :	Taille :	
Entrée :	101	6	(16 bits)
Sortie :	100	6	(16 bits)
Configuration :	6	0	(8 bits)
Entrée d'état :			
Sortie d'état :			

Etat : Hors ligne

OK Annuler Appliquer Aide

Once configured, the data objects are automatically updated and linked with the implicit exchanges mechanism:

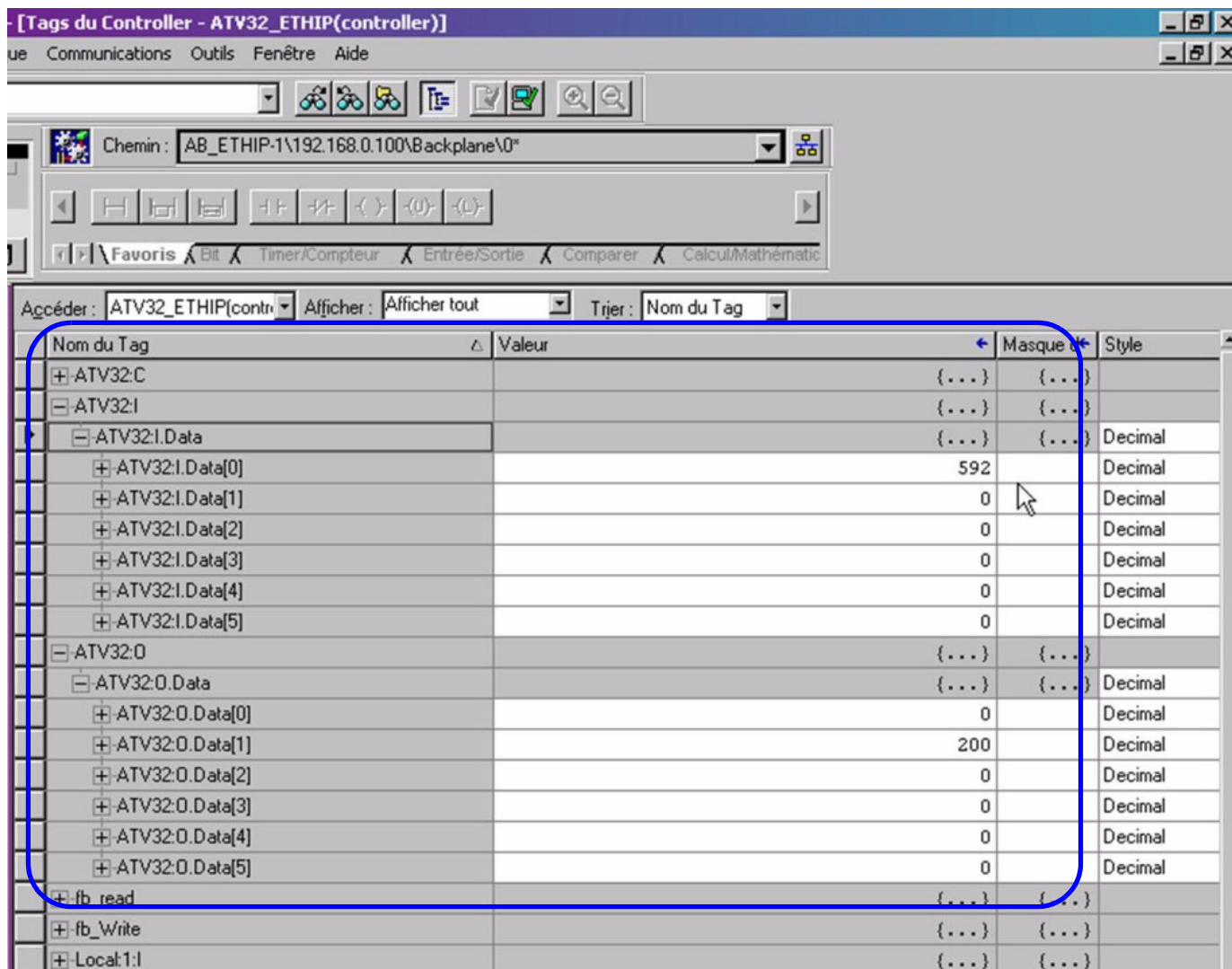

The assemblies are linked to the Option card communication scanner - see relative chapter - the example is based on the default values of the communication scanner.

I/O	PLC data	ATV32 parameter	Linked to: (Through Communication scanner)
Input	ATV32:I.Data[0]	(DPA1)	(EER)
	ATV32:I.Data[1]	(DPA2)	(rFrd)
Output	ATV32:O.Data[0]	(DCA1)	(Cnd)
	ATV32:O.Data[1]	(DCA2)	(LFrd)

Configuration of the Communication Scanner

The communication scanner is accessible via the following menus: **[COMMUNICATION]** (*C O N -*) and **[COMMUNICATION CARD]** (*c b d*) submenus.

The 6 output variables and the 6 input variables are assigned by means of parameters (*O C A 1*) to (*O C A 6*) and (*O N A 1*) to (*O N A 6*). An (*O C A x*) or (*O N A x*) parameter with a value of zero is not linked to a parameter in the drive.

These 6 parameters are described in the table below.

(*O C A x*) or (*O N A x*) defines the addresses.

[Scan.Out1 address]	(<i>O C A 1</i>)	(<i>E N d</i>)
[Scan.Out2 address]	(<i>O C A 2</i>)	(<i>L F r d</i>)
[Scan.Out3 address]	(<i>O C A 3</i>)	0
[Scan.Out4 address]	(<i>O C A 4</i>)	0
[Scan.Out5 address]	(<i>O C A 5</i>)	0
[Scan.Out6 address]	(<i>O C A 6</i>)	0
[Scan.IN1 address]	(<i>O N A 1</i>)	(<i>E t A</i>)
[Scan.IN2 address]	(<i>O N A 2</i>)	(<i>r F r d</i>)
[Scan.IN3 address]	(<i>O N A 3</i>)	0
[Scan.IN4 address]	(<i>O N A 4</i>)	0
[Scan.IN5 address]	(<i>O N A 5</i>)	0
[Scan.IN6 address]	(<i>O N A 6</i>)	0

Configuration of the Communication Period

In the module properties dialog box, you must also define the period for the implicit exchanges.

NOTE: This is also used for monitoring the connection. The option will time-out its connexion after a fixed time which is defined by 3 X RPI period (Requests packet Interval), only for Rockwell automat.

Example

RPI = 20ms. Time out occurs after 60ms if no implicit exchanges are requested by the scanner.

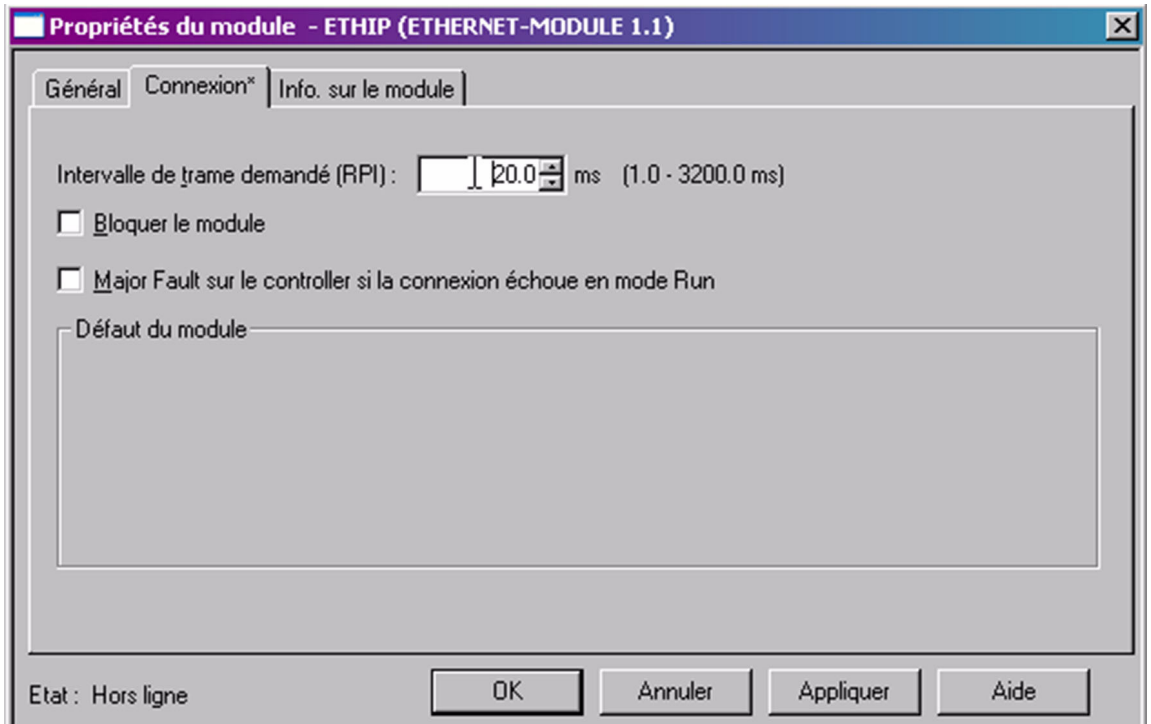

Explicit Messaging

By using the MSG function of the PLC, it is possible to get or set the value of the parameters. The access to the parameters is obtained by the use of the CIP addresses.

The screenshot shows a PLC software interface with a ladder logic diagram. The diagram consists of two rungs:

- Rung 0: A normally open contact labeled 'start_read' is connected to a coil labeled 'fb_read.EN'. This coil is connected to an MSG block labeled 'fb_read'. The MSG block has inputs for 'Type - CIP Generic' and 'Message Control', and outputs for 'EN', 'DN', and 'ER'.
- Rung 1: A normally open contact labeled 'start_Write' is connected to a coil labeled 'fb_Write.EN'. This coil is connected to an MSG block labeled 'fb_Write'. The MSG block has inputs for 'Type - CIP Generic' and 'Message Control', and outputs for 'EN', 'DN', and 'ER'.

A blue arrow points from the 'fb_read' MSG block in the diagram to the 'Configuration du Message - fb_read' dialog box. The dialog box has three tabs: 'Configuration', 'Communication', and 'Tag'. The 'Configuration' tab is active and shows the following settings:

- Type de message : CIP Generic
- Type de service : Obtenir un seul attribut
- Elément source : [Empty]
- Longueur Source : 0 (Octets)
- Code de service : e (Hexa) Classe : 8e (Hexa) Elément destinataire : read_value
- Instance : 1 Attribut : 2 (Hexa)
- Buttons: Nouveau Tag...
- Radio buttons: Activer Activer attente Démarrer Terminé
- Longueur accomplie : 2
- Code d'erreur : Code d'erreur étendu : Temps dépassé
- Chemin de l'erreur : Texte de l'erreur :
- Buttons: OK, Annuler, Appliquer, Aide

Then define the Path to the device:

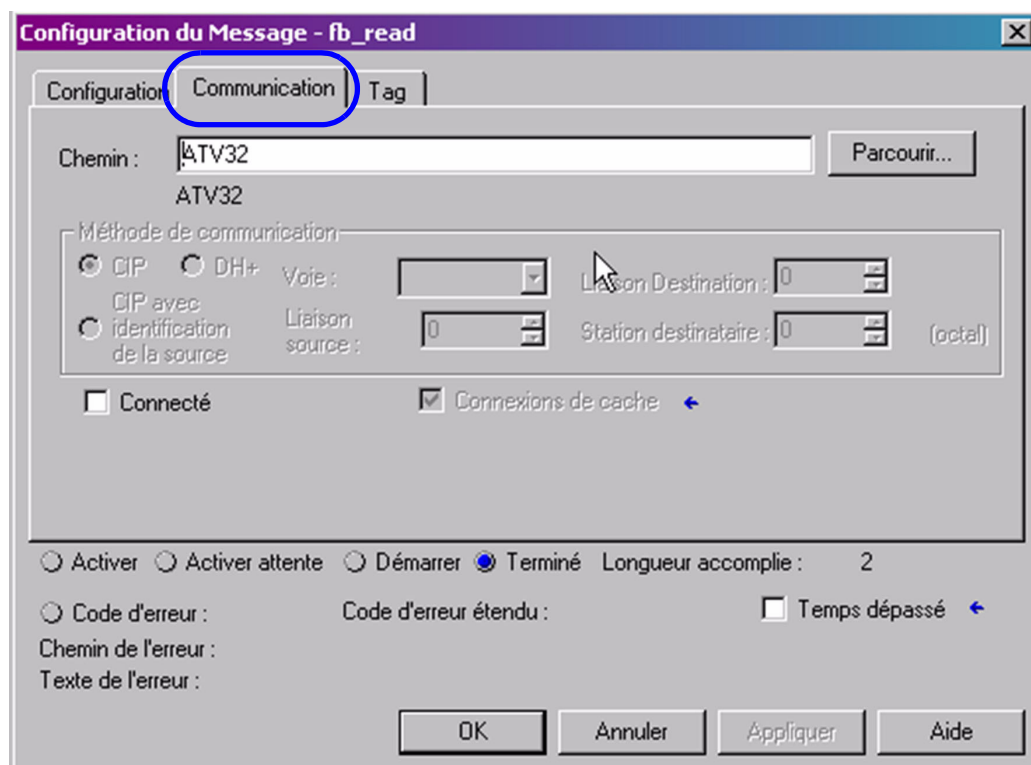

Assembly Selection

The choice of the assembly set should be done from the PLC, by applying the required assembly number to the following objects:

- Output assembly: 5/0/64
- Input assembly: 5/0/65

The default setting of these assemblies is 100 and 101.

It is recommended to set by program (when PLC starts) the assemblies needed for the application.

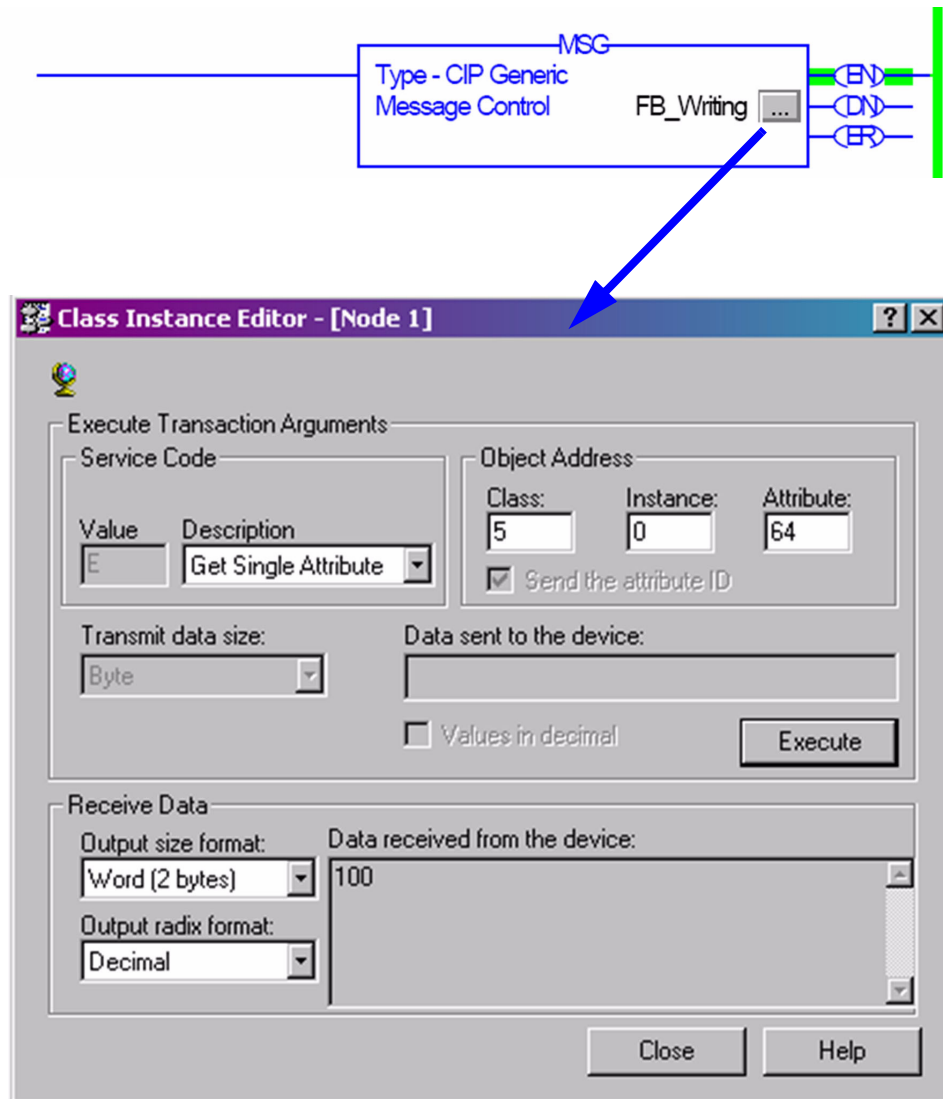

CIP Objects

17

What's in this Chapter?

This chapter contains the following topics:

Topic	Page
Supported Object Classes	124
Identity Object (F1h)	124
Message Router Object (F2h)	127
TCP/IP Interface Object (F5h)	127
Ethernet Link Object (F6h)	130
Assembly Object (04 hex)	131
Connection Manager Object (06h)	133
Motor Data Object (28h)	135
Control Supervisor Object (29h)	136
AC/DC Drive Object (2Ah)	137
Application Object (70h to C7h) / Explicit Messaging	140

Supported Object Classes

Three categories of object classes can be defined:

- CIP device on Ethernet/IP
- AC/DC drive
- VSD specific

These objects are detailed in the table below:

Object class	Class ID	Cat.	No. of instances	Effect on behavior interface
Identity	16#01	1	1	Supports the reset service
Message router	16#02	1	1	Explicit message connection
Ethernet link	16#F6	1	1	Counter and status information
TCP/IP interface	16#F5	1	1	TCP/IP configuration
Connection manager	16#05	1	1	
Motor data	16#28	2	1	Defines data for the motor connected to the device
Control supervisor	16#29	2	1	Manages drive functions, operational states, and control
AC/DC drive	16#2A	2	1	Provides drive configuration
Assembly	16#04	2	12	Defines I/O data format
Application		3	1	Vendor specific object - drive's parameters

Identity Object (F1h)

The Identity object provides identification and status information about the drive.

Class Code

Hexadecimal	Decimal
16#01	1

Class Attributes

Attribute ID	Access	Name	Data type	Value	Details
1	Get	Revision	UINT	1	-
2	Get	Max Instances	UINT	1	1 defined instance
3	Get	Number of Instances	UINT	1	-
4	Get	Optional attribute list	UINT	1	-
6	Get	Max ID of class attributes	UINT	7	-
7	Get	Max ID of instance attribute	UINT	17	-

Instance Attributes

Attribute ID	Access	Name	Data type	Value	Details
1	Get	Vendor ID	UINT	f(Brand)	243
2	Get	Device type	UINT	f(Brand) 00h 02h	AC/DC drive profile (02h)
3	Get	Product code	UINT	f(Brand)	16#1808
4	Get	Revision	Struct of: USINT USINT	f(Brand)	Major = High byte of (C 15 U) Minor = Low byte of (C 15 U)
5	Get	Status	WORD	-	See definition in the table below
6	Get	Serial number	UDINT	-	1st byte: 16#18 2nd...4th byte: last 3 bytes of MAC-ID
7	Get	Product name	Struct of: USINT STRING	-	ATV32

Attribute 5–Status

Bit	Definition	How
0	Owned by Master (predefined Master/Slave Connection)	No interface
2	Configured	If any of the product (option + drive) NVS attributes has changed from their default (out of box values) NOTE: Network comm attributes are not included here.
4-7	Extended device status: See below	-
8	Minor Recoverable Fault	No minor rec. fault
9	Minor Unrecoverable Fault	No minor unrec. fault
10	Major Recoverable Fault	C n F detected error or CIP connection timeout or Eth network overload
11	Major Unrecoverable Fault	I L F detected fault, eeprom failed, OB hardware detected error
Others	Reserved 0	-

Bit 4-7 Definition

Bit 4-7	Definition	How
0 0 0 0	Self testing or unknown	Not used
0 0 0 1	Firmware update in progress	Not used
0 0 1 0	At least on faulted I/O connection	-
0 0 1 1	No I/O connections established	-
0 1 0 0	Non-volatile configuration bad	Non volatile memory detected error in OB
0 1 0 1	Major fault - either bit 10 or 11 is true	Bit 10 or 11 is true
0 1 1 0	At least one I/O connection in run mode	-
0 1 1 1	At least one I/O connection established, all in idle mode	-
1 0 0 0 1 0 0 1	Reserved, shall be 0	-
1 0 1 0 to 1 1 1 1	Vendor specific	-

Supported Class Services

Service code	Service Name	Description
01 hex	Get_Attribute_All	Read all attributes
0E hex	Get_Attribute_Single	Read one attributes

Supported Instance Services

Service code	Service Name	Description
01 hex	Get_Attribute_All	Read all attributes
0E hex	Get_Attribute_Single	Read one attributes
10 hex	Set_Attribute_Single	Write one attribute
05 hex	Reset	Perform the reset of the drive

State Diagram for the Identity Object

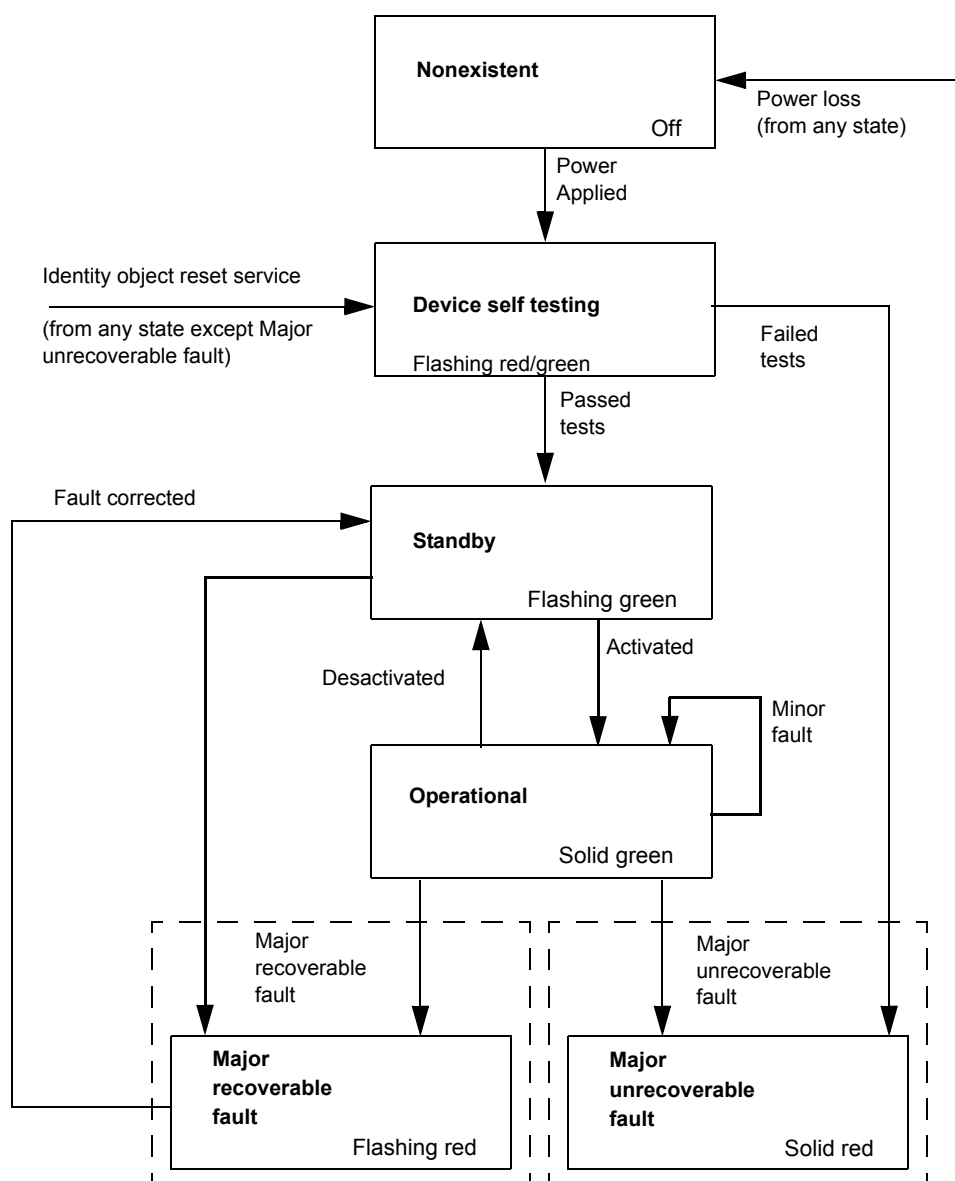

Message Router Object (F2h)

The Message router object is the element through which all the “Explicit messages” objects pass in order to be directed towards the objects they are truly destined to.

Class Code

Hexadecimal	Decimal
16#02	2

Class Attributes

Attribute ID	Access	Name	Need	Data type	Value	Details
1	Get	Revision	Opt.	UINT	1	-
2	Get	Max instances	Opt.	UNT	1	1 Defined instance

TCP/IP Interface Object (F5h)

Supported Class Attributes

Attribute ID	Access	Name	Data type	Value	Details
1	Get	Revision	UINT	1	-
2	Get	Max Instances	UINT	1	1 defined instance
3	Get	Number of Instances	UINT	1	-
4	Get	Optional attribute list	UINT	1	-
5	Get	Optional service list	UINT	1	-
6	Get	Max ID of class attributes	UINT	7	-
7	Get	Max ID of instance attribute	UINT	6	-

Supported Instance Attributes

Attribute ID	Access	Name	Data type	Details
1	Get	Status	DWORD	0 = The Interface Configuration attribute has not been configured 1 = The Interface Configuration attribute contains valid configuration
2	Get	Configuration capability	DWORD	Bit 0 = 1 (TRUE) shall indicate the device is capable of obtaining its network configuration via BOOTP Bit 1 = 1 (TRUE) shall indicate the device is capable of resolving host names by querying a DNS server Bit 2 = 1 (TRUE) shall indicate the device is capable of obtaining its network configuration via DHCP Bit 3 = 1 (TRUE) shall indicate the device is capable of sending its host name in the DHCP request Bit 4 = 1 (TRUE) shall indicate the Interface Configuration attribute is settable. Bit 5-31: reserved
3	Get/Set	Configuration control	DWORD	Bits 0-3 Start-up configuration 0 = The device shall use the interface configuration values previously stored 1 = The device shall obtain its interface configuration values via BOOTP 2 = The device shall obtain its interface configuration values via DHCP upon start-up ⁽¹⁾ 3-15 = Reserved for future use Bit 4 = 1 (TRUE), the device shall resolve host names by querying a DNS server Bit 5-31: reserved
4	Get	Physical Link Object	STRUCT of UINT EPATH	Path Size Path: Logical segments identifying the physical link object Example [20][F6][24][01]: [20] = 8 bit class segment type; [F6] = Ethernet Link Object class; [24] = 8 bit instance segment type; [01] = instance 1
5	Get/Set	Interface Configuration	STRUCT of UDINT UDINT UDINT UDINT UDINT String	IP address (0: no address configured) Network Mask (0: no Network mask configured) Gateway address (0: no address configured) Name server address (0: no address configured) Name server address 2 (0: no address configured) Domain Name
6	Get/Set	Host Name	String	Read/write name of the drive
8	Get/Set	TTL value	USINT	TTL value for Ethernet/IP multicast packets
9	Get/Set	Mcast Config	Struct Of.	IP Multicast address configuration
		Alloc Control	USINT	0 - Use default allocation algorithm to generate multicast addresses 1 - Multicast addresses shall be allocated according to the values in Num Mcast and Mcast Start Addr
		Reserved	USINT	Shall be 0
		Num Mcast	UINT	Number of multicast addresses to allocate for EtherNet/IP
		Mcast Start Addr	UDINT	Starting multicast address from which to begin allocation

(1) If set option board parameter OBP:FDRU=0 will also be set to implicitly disable the FDR mechanism on the DHCP protocol. This to be compatible with CIP tools that has configured the device to operate in a non-FDR specific environment. The user has to manually enable the feature if desired to be used.

Supported Class Services

Service Code	Service Name	Description
01 hex	Get_Attribute_All	Read all attributes
0E hex	Get_Attribute_Single	Read one attribute
10 hex	Set_Attribute_Single	Write one attribute

Supported Instance Services

Service Code	Service Name	Description
0E hex	Get_Attribute_Single	Read one attribute
10 hex	Set_Attribute_Single	Write one attribute
01 hex	Get_Attribute_All	

TCP/IP Interface Behavior

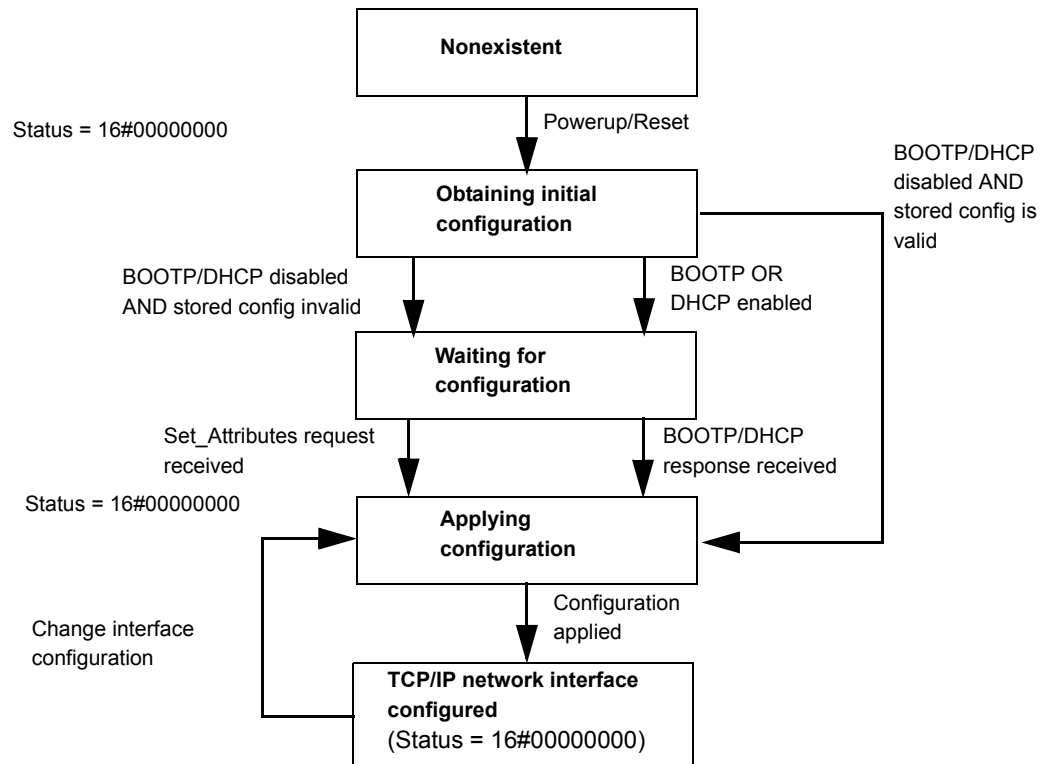

Ethernet Link Object (F6h)

Supported Class Attributes

Attribute ID	Access	Name	Data type	Value	Details
1	Get	Revision	UINT	1	-
2	Get	Max Instances	UINT	1	1 defined instance
3	Get	Number of Instances	UINT	1	-
6	Get	Max ID of class attributes	UINT	7	-
7	Get	Max ID of instance attribute	UINT	6	-

Supported Instance Attributes

Attribute ID	Access	Name	Data type	Details
1	Get	Interface Speed	UDINT	Interface speed currently in use
2	Get	Interface Flags	DWORD	<p>Bit 0: Link Status Indicates whether or not the Ethernet 802.3 communications interface is connected to an active network. 0 indicates an inactive link; 1 indicates an active link</p> <p>Bit 1: Half/Full Duplex Indicates the duplex mode currently in use. 0 indicates the interface is running half duplex; 1 indicates full duplex</p> <p>Bit 2-4: Negotiation Status</p> <ul style="list-style-type: none"> - 0 = Auto-negotiation in progress - 1 = Auto-negotiation and speed detection failed - 2 = Auto negotiation failed but detected speed Duplex was defaulted - 3 = Successfully negotiated speed and duplex - 4 = Auto-negotiation not attempted. Forced speed and duplex <p>Bit 5: Manual Setting Requires Reset. 0 indicates the interface can activate changes to link parameters (auto-negotiate, duplex mode, interface speed) automatically. 1 indicates the device requires a Reset service be issued to its Identity Object in order for the changes to take effect.</p> <p>Bit 6: Local Hardware Fault. 0 indicates the interface detects no local hardware fault; 1 indicates a local hardware fault is detected. The meaning of this is product-specific</p> <p>Bit 7-31: Reserved Shall be set to zero</p>
3	Get	Physical Address	USINT [6]	MAC layer address
4	Get	Interface counters	-	-
5	Get	Media counters	-	-
6	Get/Set	Interface Control	-	Force auto negotiate, half full and speed
7	Get	Interface Type	USINT	2
10	Get	Interface Label	SHORT_STRING	RS3: Instance 1: "Left" RS3: Instance 2: "Right" SERVO3: Instance 1: "Top" SERVO3: Instance 2: "Bottom"

Supported Class Services

Service code	Service Name	Description
0E hex	Get_Attribute_Single	Read one attribute
01 hex	Get_Attribute_All	-

Supported Instance Services

Service Code	Service Name	Description
0E hex	Get_Attribute_Single	Read one attribute
10 hex	Set_Attribute_Single	Write one attribute
01 hex	Get_Attribute_All	-
4C hex	Get_And_Clear	Same than Get_Attribute_Single

Assembly Object (04 hex)**Supported Class Attributes**

Attribute ID	Access	Name	Data type	Value	Details
1	Get	Revision	UINT	2	-
2	Get	Max Instances	UINT	1	1 defined instance
3	Get	Number of Instances	UINT	1	
6	Get	Max ID of class attributes	UINT	7	
7	Get	Max ID of instance attribute	UINT	3	

Supported Instances

Attribute ID	Access	Name	Data type	Value	Details
3	Get/Set	Data	ARRAY OF BYTE		
4	Get	Size	UINT		

Supported Instances for Altivar 32

Instance	Type	Name
20	AC Drive Output	CIP Basic Speed Control Output
21	AC Drive Output	CIP Extended Speed Control Output
70	AC Drive Input	CIP Basic Speed Control Input
71	AC Drive Input	CIP Extended Speed Control Input
100	AC Drive Output	Native Drive Output
101	AC Drive Input	Native Drive Input

Supported Class Services

Service code	Service Name	Description
0E hex	Get_Attribute_Single	Read one attribute

Supported Instance Services

Service Code	Service Name	Description
0E hex	Get_Attribute_Single	Read one attribute
10 hex	Set_Attribute_Single	Write one attribute

Output instance data description

Instance	Byte	Bit7	Bit6	Bit5	Bit4	Bit3	Bit2	Bit1	Bit0
20	0	X	X	X	X	X	Fault Reset 0 = No command 1= Fault Reset	X	Run Forward 0 = Stop 1 = Run
	1	X	X	X	X	X	X	X	X
	2-3	Speed Actual (rpm)							
21	0	X	Net Reference 0 = Local, by terminal 1= Network	Net Command 0 = Local 1 = Network	X	X	Fault Reset 0=No command 1= Fault Reset	Run Fwd / Reverse: 00: Quick stop 01: Run forward 10: Run reverse 11: No action (no freewheel stop as in legacy because asked by CIP)	
	1	X	X	X	X	X	X	X	X
	2-3	Speed Actual (rpm)							
100	0-1	I/O Scanning word 1							
	2-3	I/O Scanning word 2							
	4-5	I/O Scanning word 3							
	6-7	I/O Scanning word 4							
	8-9	I/O Scanning word 5							
	10-11	I/O Scanning word 6							
70	0	X	X	X	X	X	0 = Stopped 1 = Running	X	0 = No fault 1 = Fault
	1	X	X	X	X	X	X	X	X
	2-3	Speed Actual (rpm)							
71	0	At Reference 0 = Not reached 1 = Reached	Ref From Net 0 = From terminal 1 = From network	Cmd From Net 0 = From terminal 1 = From network	Ready 0 = Not ready 1 =Ready	Running Fwd / reverse 00: Stopped 01: Running Forward 10: Running reverse 11: Not used		Warning 0 = No warning 1 = Warning	Not used
	1	X	X	X	X	X	000: Not used 001: Startup 010: Not ready 011: Ready 100: Enabled 101: Stopping 110: Fault stop 111: Faulted		
	2-3	Speed Actual (rpm)							
101	0-1	Scanner Read word 1							
	2-3	Scanner Read word 2							
	4-5	Scanner Read word 3							
	6-7	Scanner Read word 4							
	8-9	Scanner Read word 5							
	10-11	Scanner Read word 6							

Connection Manager Object (06h)

Class Code

Hexadecimal	Decimal
16#05	5

Class Attributes

Attribute ID	Access	Name	Need	Data type	Value	Details
1	Get	Revision	Opt.	UINT	1	-
2	Get	Max instances	Opt.	UINT	4	3 defined instances

Attributes of Instance 1 - Explicit Message Instance

Attribute ID	Access	Name	Need	Data type	Value	Details
1	Get	State	Req.	USINT	-	0: Non-existent 3: Established 5: Deferred Delete
2	Get	Instance_type	Req.	USINT	0	Explicit Message
3	Get	TransportClass_trigger	Req.	BYTE	16#83	Class 3 server
4	Get	Produced_connection_id	Req.	UINT	10xxxxxx011	xxxxxx = Node address
5	Get	Consumed_connection_id	Req.	UINT	10xxxxxx100	xxxxxx = Node address
6	Get	Initial_comm_characteristics	Req.	BYTE	16#21	Explicit messaging via Group 2
7	Get	Produced_connection_size	Req.	UINT	36	Produced data maximum size (in bytes)
8	Get	Consumed_connection_size	Req.	UINT	36	Consumed data maximum size (in bytes)
9	Get/Set	Expected_packet_rate	Req.	UINT	2500	2.5 sec. (TimeOut)
12	Get/Set	Watchdog_timeout_action	Req.	USINT	1 or 3	1: Auto-Delete 3: Deferred Delete (Default)
13	Get	Produced connection path length	Req.	UINT	0	Length of attribute 14 data
14	Get	Produced connection path	Req.	Array of UINT	Null	Empty
15	Get	Consumed connection path length	Req.	UINT	0	Length of attribute 16 data
16	Get	Consumed connection path	Req.	Array of UINT	Null	Empty

Refer to Ethernet/ specification for more information.

Supported Class Attributes

Attribute ID	Access	Name	Data type	Value	Details
1	Get	Revision	UINT	1	-
2	Get	Max Instances	UINT	1	1 defined instance
3	Get	Number of Instances	UINT	1	-
4	Get	Optional attribute list	STRUCT of		List of optional attribute numbers
6	Get	Max ID of class attributes	UINT	7	-
7	Get	Max ID of instance attributes	UINT		Attribute ID number of last class attribute

Supported Instance1 (Explicit) Attributes

Attribute ID	Access	Name	Data type	Details
1	Get	Open Requests	UINT	Number of Forward Open service requests received.
2	Get	Open Format Rejects	UINT	Number of Forward Open service requests which were rejected due to bad format.
3	Get	Open Resources Rejects	UINT	Number of Forward Open service requests which were rejected due to lack of resources.
4	Get	Open Other Rejects	UINT	Number of Forward Open service requests which were rejected for reasons other than bad format or lack of resources.
5	Get	Close Requests	UINT	Number of Forward Close service requests received.
6	Get	Close Format Requests	UINT	Number of Forward Close service requests which were rejected due to bad format.
7	Get	Close Other Requests	UINT	Number of Forward Close service requests which were rejected for reasons other than bad format.
8	Get	Connection Timeouts	UINT	Total number of connection timeouts that have occurred in connections controlled by this Connection Manager

Supported Class Services

Service code	Service Name	Description
01 hex	Get_Attribute_All	Read all attributes
0E hex	Get_Attribute_Single	Read one attribute

Supported Instance Services

Service Code	Service Name	Description
0E hex	Get_Attribute_Single	Read one attribute
10 hex	Set_Attribute_Single	Write one attribute
4Ehex	Forward_Close	Closes a connection
54hex	Forward_Open	Opens a connection, maximum data size is 511 bytes

Motor Data Object (28h)

Supported Class Attributes

Attribute ID	Access	Name	Data type	Value	Details
1	Get	Revision	UINT	1	-
2	Get	Max Instances	UINT	1	1 defined instance
3	Get	Number of Instances	UINT	1	-
6	Get	Max ID of class attributes	UINT	7	-
7	Get	Max ID of instance attribute	UINT	15	-

Supported Instance Attributes

Attribute ID	Access	Name	Need	Data type	ATV32	Details
1	Get	NumAttr	Opt.	USINT	No	-
2	Get	Attributes List	Opt.	USINT (ARRAY)	No	-
3	Get	MotorType	Req.	USINT	Yes	-
6	Get/Set	RatedCurrent	Req.	UINT	Yes	Motor nominal current Linked to NCR drive parameter. NCR unit is 0,1 A as attribute 6.
7	Get/Set	RatedVoltage	Req.	UINT	Yes	Motor nominal voltage Linked to UNS drive parameter UNS unit is 1V as attribute 7
8	Get/Set	RatedPower	Opt.	UINT	No	-
9	Get/Set	RatedFreq	Opt.	UINT	Yes	Motor nominal frequency Linked to FRS drive parameter FRS unit is 0,1 Hz. The parameter value has to be divided by 10 to be in the unit of attribute 9
12	Get/Set	PoleCount	Opt.	UINT	No	-
15	Get/Set	BaseSpeed	Opt.	UINT	Yes	Motor nominal speed Linked to NSP drive parameter NSP unit is 1rpm as attribute 15

Supported Class Services

Service Code	Service Name	Description
0E hex	Get_Attribute_Single	Read one attribute

Supported Instance Services

Service Code	Service Name	Description
0E hex	Get_Attribute_Single	Read one attribute
10 hex	Set_Attribute_Single	Write one attribute

Control Supervisor Object (29h)

Supported Class Attributes

Attribute ID	Access	Name	Data type	Value	Details
1	Get	Revision	UINT	1	-
2	Get	Max Instances	UINT	1	1 defined instance
3	Get	Number of Instances	UINT	1	-
6	Get	Max ID of class attributes	UINT	7	-
7	Get	Max ID of instance attribute	UINT	17	-

Supported Instance Attributes for Schneider Electric

Attribute ID	Access	Name	Data type	Details
3	Get/Set	Run Fwd	BOOL	On edge (0 --> 1)
4	Get/Set	Run Rev	BOOL	On edge (0 --> 1)
5	Get/Set	Net Ctrl	BOOL	0: Local Control 1: Network Control (default)
6	Get	State	USINT	See state machine: 0: 1: Startup 2: Not_Ready 3: Ready 4: Enabled 5: Stopping 6: Fault_stop 7: Faulted
7	Get	Running Fwd	BOOL	ETA.15 = 0
8	Get	Running Rev	BOOL	ETA.15=1
9	Get	Ready	BOOL	ETA.1=1
10	Get	Faulted	BOOL	ETA.7=1
12	Get/Set	Fault Rst	BOOL	CMD.7 = 1.
13	Get	Fault Code	UINT	Parameter <i>ErrCd</i>
15	Get	Ctrl From Net	BOOL	0: Local Control 1: Network Control
16	Get/Set	DN Fault Mode	USINT	Action on loss of CIP network. 0: Stop + <i>CnF</i> detected fault 1: Ignored
17	Get/Set	ForceFault/Trip	BOOL	Force <i>CnF</i> detected fault (On edge)

Supported Class Services

Service Code	Service Name	Description
0E hex	Get_Attribute_Single	Read one attribute

Supported Instance Services

Service Code	Service Name	Description
0E hex	Get_Attribute_Single	Read one attribute
10 hex	Set_Attribute_Single	Write one attribute
05 hex	Reset	Reset drive

Control Supervisor States

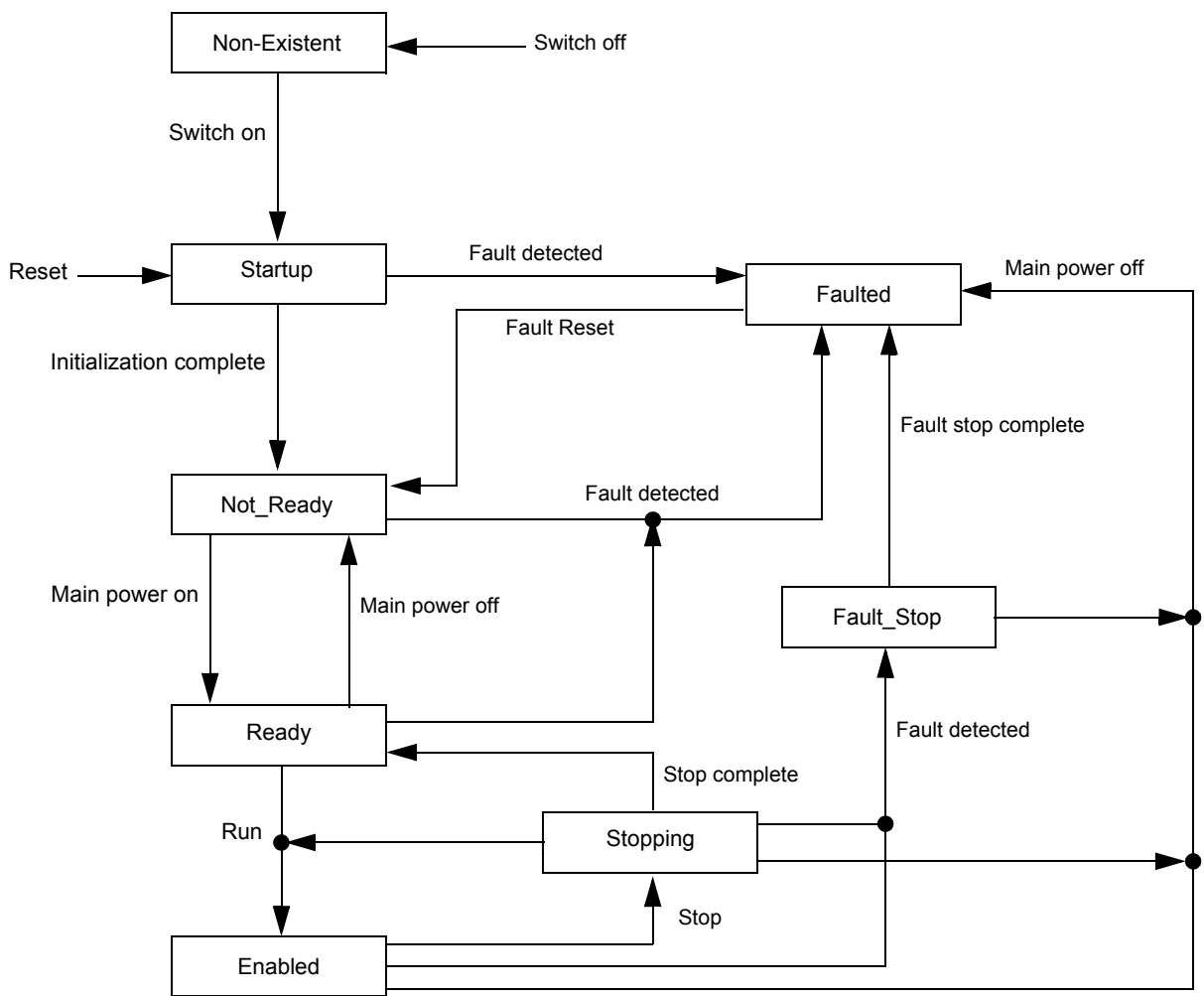

AC/DC Drive Object (2Ah)

Supported Class Attributes

Attribute ID	Access	Name	Data type	Value	Details
1	Get	Revision	UINT	1	-
2	Get	Max Instances	UINT	1	1 defined instance
3	Get	Number of Instances	UINT	1	-
6	Get	Max ID of class attributes	UINT	7	-
7	Get	Max ID of instance attribute	UINT	21	-

Supported Instance

Attribute ID	Access	Name	Need	Data type	ATV32	Comments
1	Get	NumAttr	Opt.	USINT	No	-
2	Get	Attributes List	Opt.	USINT (ARRAY)	No	-
3	Get	At Reference	Opt.	BOOL	Yes	Use the result of the "reference reached" function of the device. No more, no less specific adjustment than what is in the drive function.
4	Get/Set	NetRef	Req.	BOOL	Yes	Image of the NetRef signal received from the network. 'Get' order returns the value written by 'Set' order. Used to manage the reference channel.
6	Get	Drive mode	Req.	USINT	Yes	Used to get the drive mode. In the standard, the attribute can also be used to set the drive mode, but it is not possible on our products. Value is fixed at 1. NOTE: On other drives this value main depends on the Motor control law set in the device.
7	Get	Speed Actual	Req.	INT	Yes	Used to get the value of the motor Speed. Unit: rpm
8	Get/Set	SpeedRef	Req.	INT	Yes	Image of the Speed Reference signal received from the network. Unit: rpm 'Get' order returns the value written by 'Set' order Used to set the speed reference in the drive.
9	Get	Current Actual	Opt.	INT	Yes	Used to get the value of the current in the motor. Unit: 0.1 Amps
10	Get/Set	Current Limit	Opt.	INT	Yes	Unit: 0,1 Amps. Used to set or get the current value used for the motor thermal protection.
11	Get	Torque Actual	Opt.	INT	Yes	Used to get the value of the motor torque Unit: 1 N.m
15	Get	Power Actual	Opt.	INT	No	Used to get the value of the output power. Unit 1 <--> 1/2PowerScale.
18	Get/Set	AccelTime	Opt.	UINT	Yes	Used to get and set the acceleration time ⁽¹⁾ Units ms ⁽²⁾
19	Get/Set	DecelTime	Opt.	UINT	Yes	Used to get and set the deceleration time ⁽¹⁾ Units: ms ⁽²⁾
20	Get/Set	LowSpdLimit	Opt.	UINT	Yes	Used to get and set the low speed limit. Units: rpm
21	Get/Set	HighSpdLimit	Opt.	UINT	Yes	Used to get and set the high speed limit. Units: rpm
26	Get/Set	PowerScale	Opt.	SINT	No	
28	Get/Set	TimeScale	Opt.	SINT	No	Default value = 0
29	Get	ReffFromNet	Opt.	BOOL	No	Used to know if the drive is processing the reference sent by the NetWork that asks the Attribute 29 value
46	Get	Cumulative Run Time	Brand	UINT	No	Cumulative run time

(1) For the standard, the acceleration and deceleration time are given to go from 0 to HighSpdLimit (attribute 21 of AC/DC drive object). For Altivar 32, the acceleration and deceleration time are given to go from 0 to the motor nominal frequency ((Fr5) parameter).

(2) Altivar 32: In the drive, the unit of acceleration and deceleration time depends on INR parameter.

(Inr) = 0: acceleration and deceleration time are in 0,01s

(Inr) = 1 (factory setting): acceleration and deceleration time are in 0,1s

(Inr) = 2: acceleration and deceleration time are in 1s

The minimal requirement is to have this attribute in ms when (Inr) parameter is in factory setting.

Attribute ID	Details
3	Attribute value = value of bit 10 of ETA drive parameter (TBC)
7	Motor speed. Linked to (<i>r F r d</i>) drive parameter (TBC). (<i>r F r d</i>) is in 1rpm on ATV32 as attribute 7
8	Speed reference. Linked to (<i>L F r d</i>) drive parameter (TBC). (<i>L F r d</i>) is in 1rpm on ATV32 as attribute 8
9	Actual current in the motor. Linked to (<i>L C r</i>) drive parameter. (<i>L C r</i>) is in 0,1A on ATV32 as attribute 9
10	Current value used for the motor thermal protection. Linked to (<i>I E H</i>) drive parameter. (<i>I E H</i>) is in 0,1A on ATV32 as attribute 10
11	Actual torque in the motor. Linked to (<i>D E r n</i>) drive parameter (TBC). (<i>D E r n</i>) is in 0,1 N.m on ATV32. The value has to be multiplied by 10 to be in the unit of attribute 11
18	Acceleration time. Linked to (<i>R C C</i>) drive parameter. See note (2) of the specification above
19	Deceleration time. Linked to (<i>D E C</i>) drive parameter. See note (2) of the specification above
20	Low speed. Linked to (<i>S n I L</i>) drive parameter. (<i>S n I L</i>) is in 1rpm on ATV32 as attribute 20
21	High speed. Linked to (<i>S n R L</i>) drive parameter. (<i>S n R L</i>) is in 1rpm on ATV32 as attribute 21

Supported Class Services

Service Code	Service Name	Description
0E hex	Get_Attribute_Single	Read one attribute

Supported Instance Services

Service Code	Service Name	Description
0E hex	Get_Attribute_Single	Read one attribute
10 hex	Set_Attribute_Single	Write one attribute

Application Object (70h to C7h) / Explicit Messaging

Application Object Behavior

Class = ((AdL - 3000) / 200) + 70h

Instance = 1

Attribute = (AdL % 200) + 1

AdL = (Class - 70h) * 200 + Attribute - 1 + 3000

This rule allows the access to address under 20599. The other address are not accessible.

The drive parameters are grouped into classes.

- Each application class has only 1 instance.
- Each instance groups 200 parameters.
- Each attribute in an instance relates to a parameter.

Example:

Drive logical address	Hexadecimal path
3 000	16# 70 / 01 / 01
3 100	16# 70 / 01 / 65
3 200	16# 71 / 01 / 01

Supported Class Attributes

Attribute ID	Access	Name	Data type	Value	Details
1	Get	Revision	UINT	1	-
2	Get	Max Instances	UINT	1	1 defined instance
3	Get	Number of Instances	UINT	1	-
6	Get	Max ID of class attributes	UINT	7	-
7	Get	Max ID of instance attribute	UINT	X	-

Supported Instance Attributes

Attribute ID	Access	Name	Data type	Details
1	Get/Set	1st parameter of the block	UINT	Value returned by the drive at Address xx
..	Value returned by the drive at Address xx
X	Get/Set	Last parameter of the block	UINT	Value returned by the drive at Address xx

Supported Class Services

Service Code	Service Name	Description
0E hex	Get_Attribute_Single	Read one attribute

Supported Instance Services

Service Code	Service Name	Description
0E hex	Get_Attribute_Single	Read one attribute
10 hex	Set_Attribute_Single	Write one attribute

