

PacT Series

ComPacT NSX & NSXm

Catalog 2026

Molded-Case Circuit Breakers
and Switch-Disconnectors
from 16 to 630 A - up to 690 V



March, 2026

se.com

Schneider
Electric

Legal Information

The information provided in this Catalog contains description of Schneider Electric products, solutions and services ("Offer") with technical specifications and technical characteristics of the performance of the corresponding Offer.

The content of this document is subject to revision at any time without notice due to continued progress in methodology, design and manufacturing.

To the extent permitted by applicable law, no responsibility or liability is assumed by Schneider Electric and its subsidiaries for any type of damages arising out of or in connection with (i) informational content of this Catalog not conforming with or exceeding the technical specifications, or (ii) any error contained in this Catalog, or (iii) any use, decision, act or omission made or taken on basis of or in reliance on any information contained or referred to in this Catalog.

SCHNEIDER ELECTRIC MAKES NO WARRANTY OR REPRESENTATION OF ANY KIND, WHETHER EXPRESS OR IMPLIED, AS TO WHETHER THIS CATALOG OR ANY INFORMATION CONTAINED THEREIN SUCH AS PRODUCTS AND SERVICES WILL MEET REQUIREMENTS, EXPECTATIONS OR PURPOSE OF ANY PERSON MAKING USE THEREOF.

Schneider Electric brand and any trademarks of Schneider Electric and its subsidiaries referred to in this Catalog are property of Schneider Electric or its subsidiaries. All other brands are trademarks of their respective owners.

This Catalog and its content are protected under applicable copyright laws and provided for informative use only. No part of this Catalog may be reproduced or transmitted in any form or by any means (electronic, mechanical, photocopying, recording, or otherwise), for any purpose, without the prior written permission of Schneider Electric.

Copyright, intellectual, and all other proprietary rights in the content of this Catalog (including but not limited to software, audio, video, text, and photographs) rests with Schneider Electric or its licensors. All rights in such content not expressly granted herein are reserved. No rights of any kind are licensed or assigned or shall otherwise pass to persons accessing this information.

Trademarks

QR Code is a registered trademark of DENSO WAVE INCORPORATED in Japan and other countries.

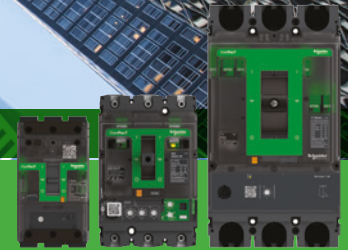

Meet the new face of connected breaker technology

70 years of innovative and reliable protection

The Schneider Electric™ Com**Pact**™ range is built on 70 years of expertise and leadership in industrial circuit breakers.

Today Schneider Electric is launching its new generation of Com**Pact** molded case circuit breakers.

The comprehensive, optimized Com**Pact** range covers your protection and has been redesigned with a superior customer experience in mind.

The range combines wireless intelligent metering and monitoring, along with advanced protective functions.

This range can be connected to Schneider Electric's open, interoperable, IoT-enabled EcoStruxure™ Power architecture. Through this platform we deliver enhanced value in terms of safety, reliability, efficiency, sustainability, and connectivity.

We leverage technologies in IoT, mobility, sensing, cloud, analytics, and cybersecurity to deliver Innovation at Every Level. This includes connected products, edge control, apps, analytics and services.

1952	1974	1994	2008	2017	2018	2021
Compact NW	Compact C	Compact NS	Compact NSX	Compact NSXm	ComPact NSX & NSXm with MicroLogic Vigi	ComPact NSX & NSXm New Generation
	Discover the New Generation of ComPact					
			2008	2020	2022	
			Compact NS	ComPact NS	ComPact NS New Generation	

se.com/compact-nsx

ComPacT NSX and NSXm, even more innovative and efficient

ComPacT circuit breakers feature Schneider Electric's exclusive Roto-Active Breaking System; it reduces the effects of short circuits of your installation.

Today, the ComPacT range is optimized with a high level of breaking capacities, outstanding selectivity and cascading. It offers more advanced functions and ergonomic designs for easy installation and operations.

Eleven Performance Levels

K | HB2 | HB1 | R | L | S | H | N | F | B | E

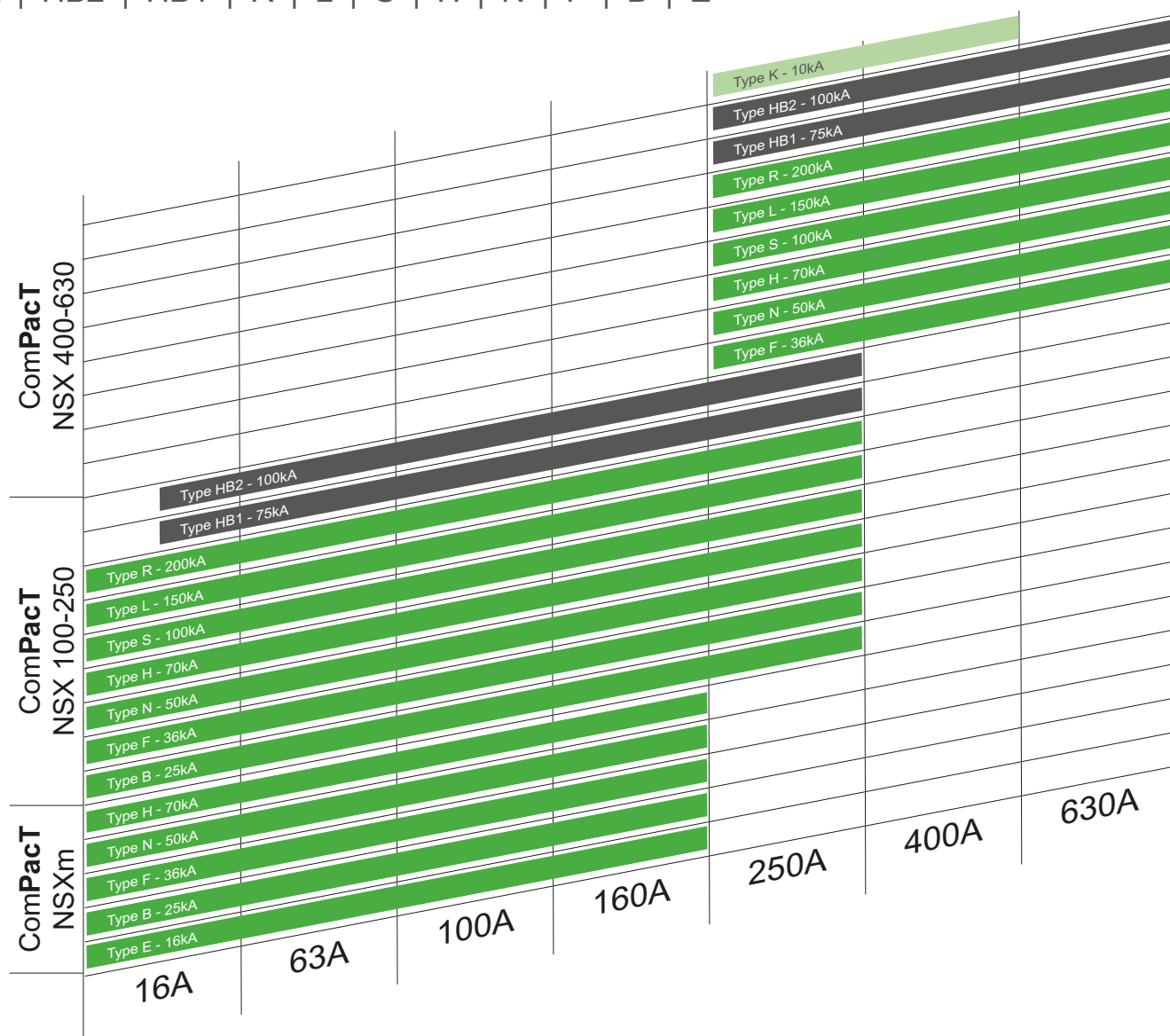

Icu = (kA rms) at 1000V AC
 Icu = (kA rms) at 690V AC
 Icu = (kA rms) at 415V AC

Schneider Electric is proud to introduce the new generation of ComPacT MCCBs. These breakers talk to you, wherever you are, in all transparency. New design complements new wireless connectivity capabilities with our latest wireless indication auxiliary.

ComPacT New BSCM Modbus SL/ULP

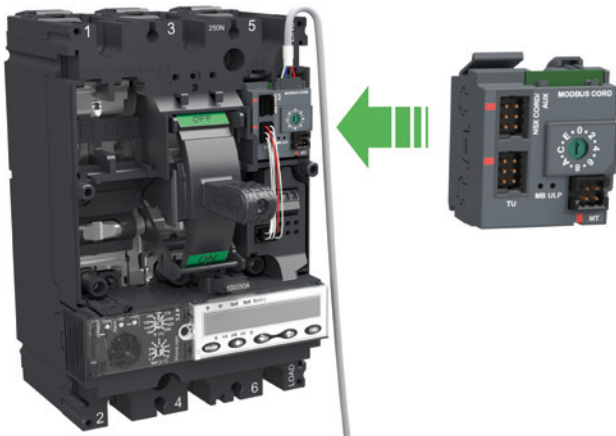

New connectivity with BSCM Modbus SL/ULP to facilitate connectivity of your ComPacT NSX

- Connectivity with two available protocols (Modbus SL and ULP) in one communicative device
- Simplified architecture with additional Modbus hub and RJ45 connections
- New architecture **reducing** installation time by 30%
- Space reduction on the panel level (one Modbus Hub instead of 3 IFMs).
- Carbon footprint reduction with meaningful design rules and sustainability impact

Wireless Indication Auxiliary



Wireless Breaker Status

Wireless technology accelerates overall wiring time: Status communication is done very simply and commissioned wirelessly. No cable connection is required; with a simple clip, the auxiliary is installed and ready for commissioning.

In case of a change on your breaker's status, you get two steps of indication:

- Remote indication (App/Software): Your ComPacT circuit breaker will send you an immediate notification via your Edge Control app/software.
- Local indication (Blinking LED): Gain time by identifying which breaker is concerned in your overall electrical architecture

Ready to meet the new face of ComPacT?



Meet the new generation of ComPacT™ circuit breakers with semi-transparent faceplate, screwless auxiliaries and remote monitoring features.

Learn about the benefits of the ComPacT range here:
se.com/compact-nxs

While we are launching a new generation of ComPacT breakers, we are building upon the very latest innovations that made the success of the range in the first place. The following innovations were launched recently and are still very much applicable to the new generation of ComPacT breakers.

ComPacT NSXm

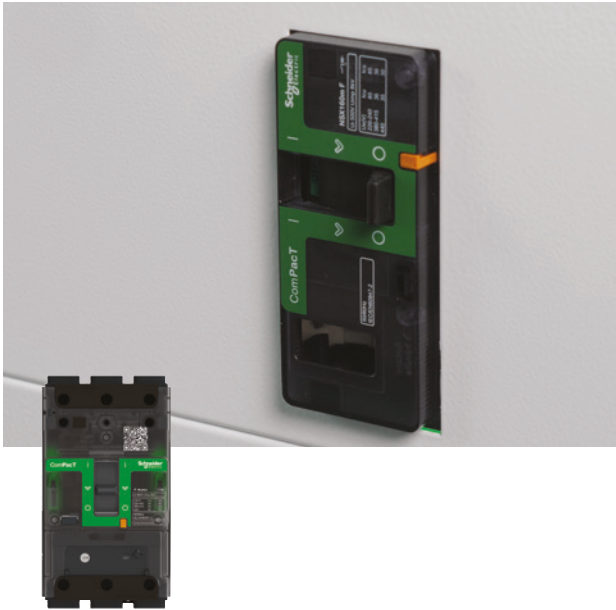

Smallest size in the range

- ComPacT NSXm is the smallest frame size in the range, incorporating new features and innovations
- Gain up to 40% in space when using with integrated earth leakage protection
- Reduce up to 40% mounting and cabling time with EverLink™ connectors, built-in DIN rail and spring-type auxiliaries
- Select, configure and commission with ease, thanks to Schneider Electric online tools: EcoStruxure Customer Lifecycle Software, such as EcoStruxure Power Design – Ecodial

MicroLogic Vigi



Integrated earth leakage protection

- Easy to integrate into a row that does not have earth leakage protection
- Simple to use, reliable, and now comes in the same frame size, and for the same panel support
- Gain up to 40% in space when using with integrated earth leakage protection into the MicroLogic Vigi trip units
- Standard protection of distribution cables
- Part of the EcoStruxure Power architecture, with digital communication capability and data management (settings, measurement, pre-alarms, trip & test history)

Innovation that protects:



Meet the new generation of ComPacT™ circuit breakers with semi-transparent faceplate, screwless auxiliaries and remote monitoring features.

Learn about the benefits of the ComPacT NSX range here:
se.com/compact-nsx

Optimized size and innovations tailored to your needs

Roto-active™ breaking technology

While the ComPacT NSXm is the smallest breaker in the ComPacT range, it nonetheless features all the innovations from previous generations, and notably includes roto-active breaking technology. Schneider Electric was the first to introduce this technology - an innovation in which the effective fault current limitation benefits the entire installation, particularly its cables.

Reduce the effects of short circuits to extend your installation life:

- Increase life duration of all items downstream of the electrical network
- Provide both outstanding selectivity and cascading

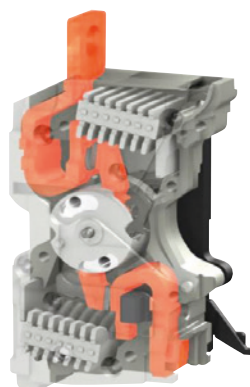

EverLink™ connectors – for enduring protection



ComPacT NSXm

The ComPacT NSXm features EverLink, an innovative cable connection method with patented creep-compensating technology that is built directly into the terminal. EverLink gives you:

- Confidence that your electrical connections maintain consistent pressure on the cable over time
- A space-saving solution as bare cable connections are as reliable as compression lug cable connections
- IP40 protection available thanks to transparent long terminal shield

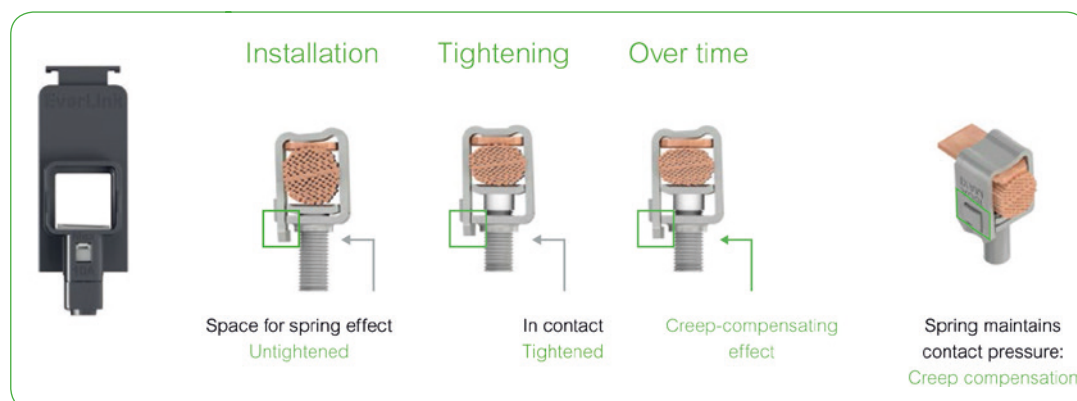



Connectivity: from corrective to predictive maintenance

As Schneider Electric's IoT-connected power supply architecture, EcoStruxure Power makes maintenance more effective, and reduces the probability and duration of blackouts. ComPacT circuit breakers play a major role in the EcoStruxure architecture, acting as watchdogs over the power supply systems, and providing data to digital architectures and monitoring software.

Corrective maintenance

EcoStruxure Power enables maintenance managers to significantly reduce power outage duration.

Example: In case of a tripped breaker, the system automatically sends email alerts. Facility managers can diagnose the incident remotely, decide upon the appropriate actions, and monitor the results.

Preventative maintenance

Enables technicians to fix issues before impacting the comfort and productivity of building occupants. This is done by:

- Sending remote warnings as soon as a creeping fault is detected, especially current leakage.
- Assisting during routine checks, ensuring all points are verified regularly and providing access to all information, including event logs, in case of suspected weakness.

The available information enables preventive maintenance based on wear-out indications and warnings sent via the digital system.

Predictive maintenance

Data collected across the power distribution network, stored and computed by Schneider Electric analytics, provides greater insight for improved long-term planning and life-cycle management. Furthermore, advanced data processing enables predictive maintenance.

Example: By analyzing historical data and monitoring load profiles, maintenance and upgrades can be scheduled efficiently.



Learn about connectivity online:



Scan or click on QR code



EcoStruxure Power connected products

Embrace an open partner ecosystem

Today's value chain in electrical distribution is highly fragmented and inefficient from design to maintenance.

With EcoStruxure Power solutions, Schneider Electric strengthens and simplifies the entire project path by shaping a unique ecosystem of specifiers, contractors, panel builders, integrators, distributors and facility managers serving end users.

450,000+

EcoStruxure installations

1 billion

connected devices

For these electrical distribution professionals, EcoStruxure Power provides opportunities to broaden and improve the services they offer their customers.

- A comprehensive and innovative range of IoT-enabled LV and MV offers
- Proven, interoperable reference architectures for any building or business
- Design, selection, commissioning and configuration tools to enhance deployment efficiencies across the project life cycle

Apps, Analytics & Services



Actionable predictive maintenance information that helps protect your customers, safeguard your reputation and minimize financial impact.

Edge Control



Track maintenance activity to reduce downtime, energy use, and maintenance costs while improving site planning and revealing additional capacity.

Connected Products



IoT-enabled low and medium voltage offers to seamlessly fit into EcoStruxure architectures.

Contribute to a better world. Enhance sustainability with ComPacT range

New packaging

- The ComPacT range comes in plastic-less packaging: not only to reduce our carbon footprint, but it also means less waste in the workshop
- Simplified instruction sheets included in all packaging
Scan the QR code on the simplified instruction sheet to access a full and digital one
- 100% recycled carton
- This product is REACH and RoHS compliant



Scan QR code for breaker updates



Each breaker is equipped with a QR code that allows you to get the latest information on your breaker.



Environmental Data Program

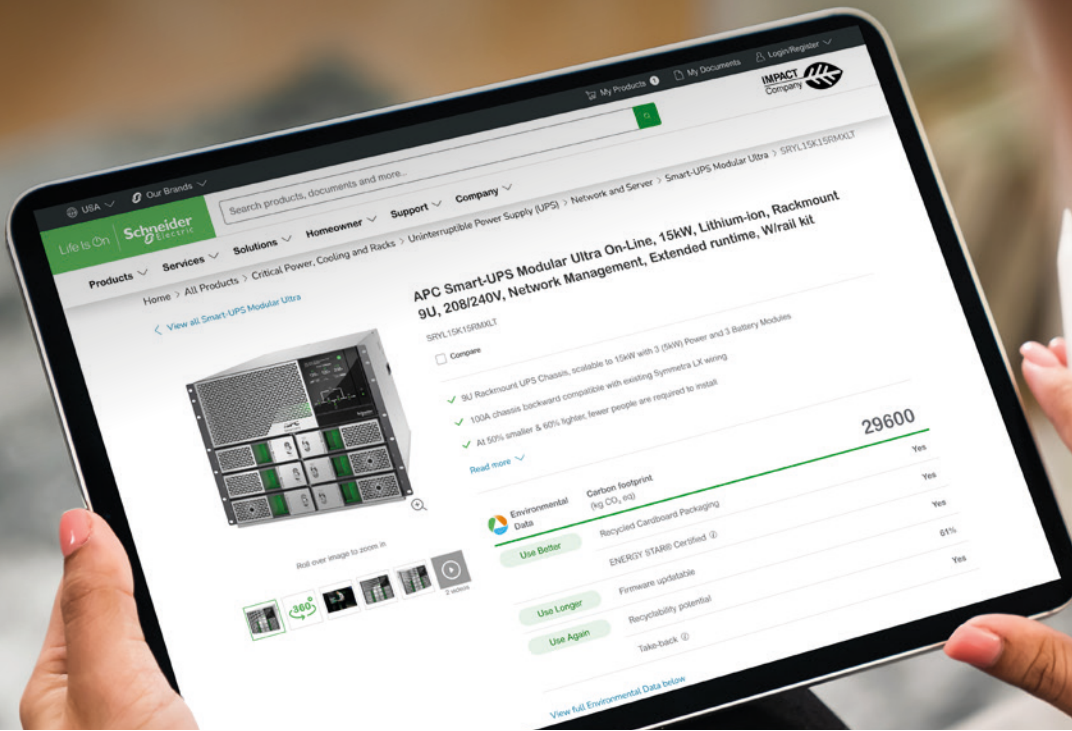

Next-level transparency for better-informed product choices

The Environmental Data Program is a framework for how we measure, categorize, and compare the environmental attributes and footprint of our products.

Using a rigorous, fact-based methodology, the program provides environmental data from across the product lifecycle.

Five data categories across the product lifecycle

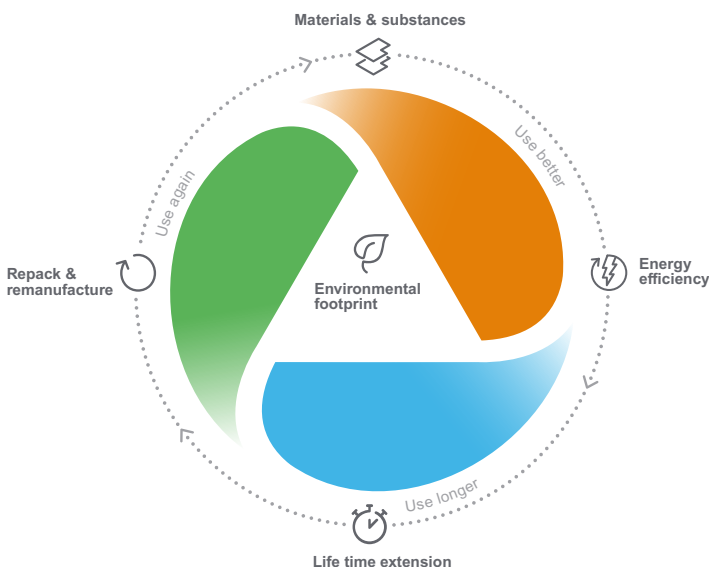

Use Better: How sustainable a product is, including environmental footprint, materials and substances, packaging, and energy efficiency.

Use Longer: How a product's life time can be effectively extended in terms of reparability and updatability.

Use Again: How a product can be reused, from dismantling and remanufacturing to recyclability and manufacturer take back.

With this transparent, verified data, customers and partners are empowered to make conscious environmental choices and accurately evaluate and report on sustainability performance.

All our hardware offers have an associated environmental data available on se.com product pages.



Learn more about the **Environmental Data Program**



General contents

ComPacT NSXm & NSX

Presentation

Select Circuit Breakers and Switch-Disconnectors

Select Protection

Customize Circuit Breakers with Accessories

Smart Panel Integration

Switchboard Integration

Catalog Numbers

Glossary

Additional Characteristics

A

B

C

D

E

F

G

H

ComPacT NSXm & NSX Application Overview

The ComPacT NSX and NSXm circuit breakers and switch-disconnectors are the best choice for all standards and specific applications.

ComPacT for Fire Prevention in 60 Seconds



ComPacT for Power Availability in 60 Seconds

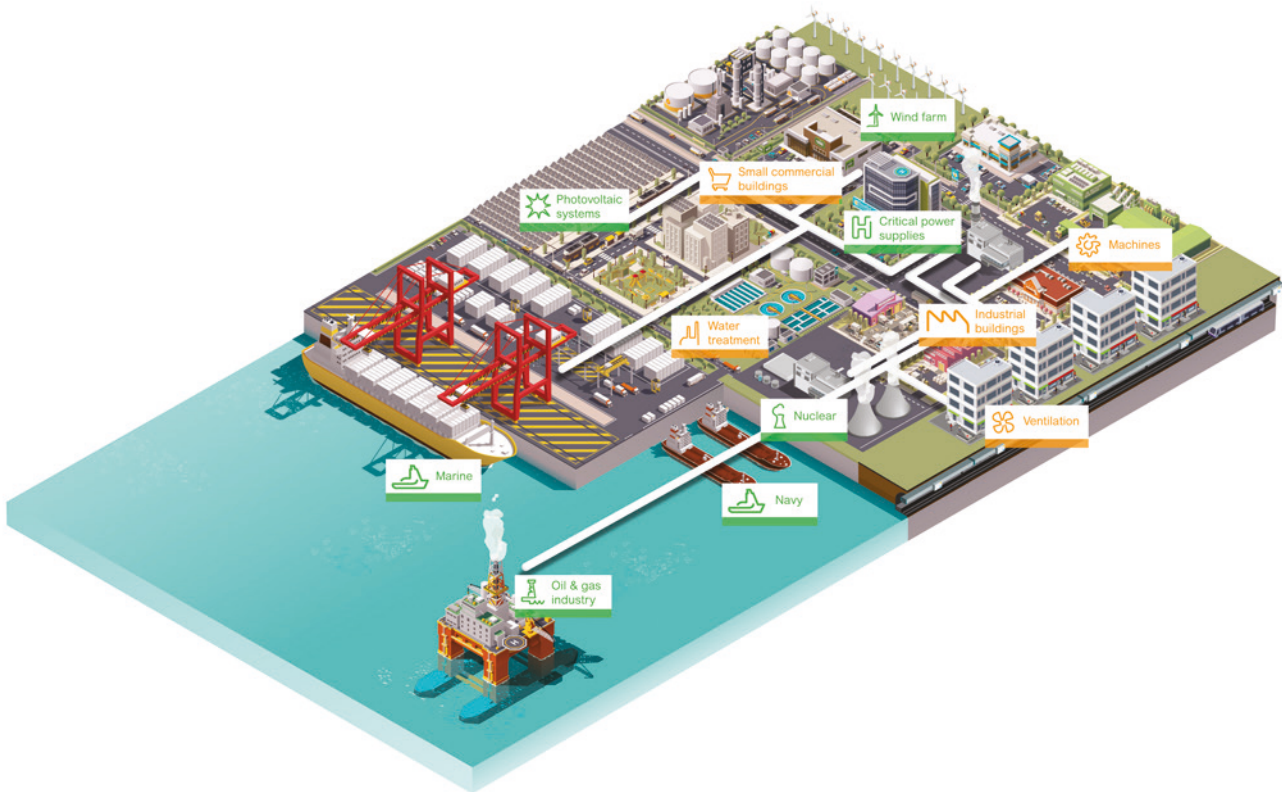

> ComPacT Switch-Disconnectors
INS-INV40 to 2500 A Catalog [a]



LVPED213024EN

> FuPacT [a]



LVPED216031EN

> Substitution and Technical Guide
ComPacT NSX High Performances [b]



LVPED221004EN

> ComPacT NSX, ComPacT INS/INV,
MasterPact NW DC - DC PV - DC EP [c]



LVPED221002EN

> TransferPacT
(Source-changeover systems) [d]



LVPED216028EN

> Selectivity, Cascading and
Coordination Guide, Complementary
Technical Information



LVPED318033EN

ComPacT NSXm & NSX

Application Overview

Buildings

ComPacT NSXm devices up to 160 A (70 kA/415 V) are equipped with thermal magnetic trip units.

ComPacT NSX devices up to 630A (200 kA/415 V) are equipped with Magnetic, Thermal Magnetic, basic electronic trip units (MicroLogic 2) and advanced electronic trip units (MicroLogic 5/6) which offer embedded metering and communication.

Both devices can protect against insulation faults thanks to their embedded earth leakage protection.

ComPacT NSXm and NSX can be easily installed at all levels in distribution systems, from main LV switchboard to the subdistribution boards and enclosures.

Industrial Buildings, Machines, Ventilation and Water Treatment

The ComPacT NSX range includes a number of versions to protect motor applications:

- Basic short-circuit protection with MA magnetic trip units or the electronic MicroLogic 1-M version, combined with an external relay to provide thermal protection.
- Protection against overloads, short-circuits with additional motor-specific protection (phase unbalance, locked rotor, underload and long start) with MicroLogic 6 E-M trip units.

These versions also offer communication, metering and operating assistance.

The exceptional limiting capacity of ComPacT NSX circuit breakers automatically provides type-2 coordination with the motor starter, in compliance with standard IEC 60947-4-1.

Buildings and Industrial Buildings

A switch-disconnector version of ComPacT NSXm and NSX circuit breakers is available for circuit control and isolation. All add-on functions of both circuit breakers may be combined with the basic switch-disconnector function.

For information on other switch-disconnector ranges, see the ComPacT INS/INV catalog and for fusegear protection see FuPacT catalog [a].

Marine

ComPacT NSX HB1/HB2 up to 630 A circuit breakers have the best-in-class breaking capacity for Marine applications (100 kA/690 V).

Devices can be equipped with thermal magnetic, basic electronic trip units (MicroLogic 2) and advanced electronic trip units (MicroLogic 5/6) which offer embedded metering and communication.

Standard ComPacT NSX breakers AC and DC ranges can be used for military navy inside the main and emergency switchboards [b].

Special Applications

The ComPacT NSX range offers a number of versions for special protection applications:

- Service connection to public distribution systems
- Generators
- Industrial control panels
- 16 Hz 2/3 systems
- 400 Hz systems [1]

For all these applications, circuit breakers in the ComPacT NSX range offer positive contact indication and are suitable for isolation in accordance with standards IEC 60947-1 and 2.

[1] ComPacT NSXm may be used on 400 Hz systems.

Photovoltaic

ComPacT NSX DC PV range up to 500 A (1000V DC), and range from 250 A to 400 A (800 to 1000 V AC), equipped with electronic trip unit MicroLogic 2 is the appropriate choice for photovoltaic generation from 10 kW to 500 kW.

Circuit breakers can be used for over-current protection.

Circuit breakers and switches can be used for isolation during maintenance phase.

ComPacT NSX is part of a Schneider Electric photovoltaic architecture which offers AC and DC protection, control and metering, inverters for DC to AC voltages and PV modules [c].

Oil and Gas

ComPacT NSX up to 630 A offers the highest breaking capacity in its class mainly required in Oil and Gas industry:

- Up to 100 kA at 690 V
- Up to 200 kA at 415 V

Devices can be equipped with thermal magnetic, basic electronic trip units (MicroLogic 2) and advanced electronic trip units (MicroLogic 5/6) which offer embedded metering and communication

ComPacT NSX range offers outstanding selectivity at 415 V and 690 V [b].

Critical Power Supplies

ComPacT NSX DC range up to 1200 A (5 kA/600 V DC) meets the requirements of UPS manufacturers keeping the same compact footprint as the standard ComPacT NSX range.

Batteries are usually used for emergency power supply and circuit breakers are used to protect the battery circuit (between the battery and the circuit) [c].

To allow a continuous supply of power, some electrical installations are connected to two power sources [d]:

- A normal source.
- A replacement source to supply the installation when the normal source is not available.

A mechanical and/or electrical interlocking system between two circuit breakers or switch-disconnectors avoids all risk of parallel connection of the sources during switching.

A source-changeover system can be:

- Manual with mechanical device interlocking
- Remote controlled with mechanical and/or electrical device interlocking
- Automatic by adding a controller to manage switching from one source to the other on the basis of external parameters.



Select Circuit Breakers and Switch-Disconnectors

Characteristics and Performance

ComPacT NSXm Circuit Breakers from 16 to 160 A up to 690 V... A-2

ComPacT NSX Circuit Breakers from 100 to 250 A up to 690 V.... A-4

ComPacT NSX Circuit Breakers from 400 to 630 A up to 690 V.... A-8

ComPacT NSXm Switch-Disconnectors from 50 to 160 A NA..... A-10

ComPacT NSX Switch-Disconnectors from 100 to 630 A NA..... A-12

General Characteristics of the ComPacT Range A-14

ComPacT NSX Special Applications

High Performance at 690 V A-16



Other Chapters

Select Protection	B-1
Customize Circuit Breakers with Accessories.....	C-1
Smart Panel Integration	D-1
Switchboard Integration.....	E-1
Catalog Numbers	F-1
Glossary	G-1
Additional Characteristics.....	H-1

Characteristics and Performance

ComPacT NSXm Circuit Breakers from 16 to 160 A up to 690 V

ComPacT New Generation Overview



A

CT12H3TM160L-eps



ComPacT NSXm

Common characteristics

Rated voltages	Insulation voltage (V)	Ui	800
	Insulation voltage for ELCB [1] (V)	Ui	500
	Impulse withstand voltage (kV)	Uimp	8
	Operational voltage (V)	Ue AC 50/60 Hz	690
	Operational voltage for ELCB [1] (V)	Ue AC 50/60 Hz	440
Suitability for isolation		IEC/EN 60947-2	yes
Utilization category			A
Pollution degree		IEC 60664-1	3
Connectivity	Compliant with IEC/EN 60947-2 Annex H		yes

Circuit breakers

Breaking Capacity Levels

Electrical characteristics as per IEC/EN 60947-2

Rated current (A)	In	40 °C
Number of poles		

Breaking capacity (kA rms)

Icu = Icu1 [3]	AC 50/60 Hz	220...240 V
		380...415 V
		440 V
		500 V
		525 V
		660...690 V

Service breaking capacity (kA rms)

Ics	AC 50/60 Hz	220...240 V
		380...415 V
		440 V
		500 V
		525 V
		660...690 V

Durability (C-O cycles)	Mechanical		
		Electrical	440 V
			In
		690 V	In/2
			In

Protection and Measurements

Overload/short-circuit protection	Thermal magnetic
	Electronic with Earth Leakage Protection (ELCB)
Options	Device status/control
	For ELCB [1]: alarming and fault differentiation

Installation/Connections

Dimensions and weights

Dimensions (mm)	3P
	4P
W x H x D	ELCB [1]
Weight (kg)	3P
	4P
	ELCB [1]

Connections

Pitch (mm)	Standard
	With spreaders
EverLink lug Cu or Al [2] cables	Cross-section (mm ²)
	Rigid
	Flexible
Crimp lugs Cu or Al	Cross-section (mm ²)
	Rigid
	Flexible

Source Changeover System

Manual mechanical interlocking

[1] ELCB: Earth Leakage Circuit Breaker (MicroLogic Vigi 4.1).

[2] Al up to 100 A.

[3] Icu1: Rated individual pole ultimate short-circuit breaking capacity at phase-to neutral AC voltage introduced in IEC 60947-2:2024.

Characteristics and Performance

ComPacT NSXm Circuit Breakers from 16 to 160 A up to 690 V



Common characteristics			
Control	Manual	With toggle	<input checked="" type="radio"/>
		With direct or extended rotary handle	<input checked="" type="radio"/>
		With side rotary handle	<input checked="" type="radio"/>
Versions	Fixed		<input checked="" type="radio"/>

NSXm up to 63 A						NSXm from 80 to 160 A and ELCB [1]				
E	B	F	N	H		E	B	F	N	H
63						160				
3, 4						3, 4				
25	50	85	90	100		25	50	85	90	100
16	25	36	50	70		16	25	36	50	70
10	20	35	50	65		10	20	35	50	65
8	10	15	25	30		-	-	-	-	-
-	-	10	15	22		-	-	-	-	-
-	-	-	10	10		-	-	-	-	-
25	50	85	90	100		25	50	85	90	100
16	25	36	50	70		16	25	36	50	70
10	20	30	50	65		10	20	30	50	65
8	10	10	25	30		-	-	-	-	-
-	-	10	15	22		-	-	-	-	-
-	-	-	2.5	2.5		-	-	-	-	-
20000										
20000										
10000										
10000										
5000										
<input checked="" type="radio"/>						<input checked="" type="radio"/>				
<input checked="" type="radio"/>						<input checked="" type="radio"/>				
<input checked="" type="radio"/>										
81 x 137 x 80										
108 x 137 x 80										
108 x 144 x 80										
1.06										
1.42										
1.63										
27										
35										
95										
70										
120										
95										
<input checked="" type="radio"/>						<input checked="" type="radio"/>				

Characteristics and Performance

ComPacT NSX Circuit Breakers from 100 to 250 A up to 690 V

A



ComPacT NSX single-pole



ComPacT NSX two-pole

Common characteristics

Utilization category	A	
Connectivity	Compliant with IEC/EN 60947-2 Annex H	2P only

ComPacT circuit breakers

Number of poles		
Control	Manual	toggle direct or extended rotary handle
Connections	Electric	front connection
		rear connection
	Fixed	front connection
		rear connection
Withdrawable	front connection	
	rear connection	

Electrical Characteristics IEC/EN 60947-2

Rated current (A)	In	40 °C
Rated insulation voltage (V)	Ui	
Rated impulse withstand voltage (kV)	Uimp	
Rated operational voltage (V)	Ue	AC 50/60 Hz DC

Type of Circuit Breaker

Ultimate breaking capacity (kA rms)	Icu = Icu1 ^[2]	AC	220/240 V
		50/60 Hz	380/415 V 440 V 500/525 V 660/690 V
Service breaking capacity (kA rms)	Ics	DC	250 V (1P) 500 V (2P)
		% Icu	
Suitability for isolation			
Durability (C-O cycles)	Mechanical		
	Electrical	277 V	In/2 In

Protection and Measurements

Type of trip units		
Ratings		In
Overload protection (thermal)	Long time threshold	Ir
Short-circuit protection (magnetic)	Instantaneous pickup	Ii
		value indicated for AC ^[1] real value for DC
Add-on earth-leakage protection	VigiPacT add-on combination with VigiPacT relay	

Additional Indication and Control Auxiliaries

Indication contacts		
Voltages releases	MX shunt release	
	MN undervoltage release	

Installation

Accessories	Terminal extensions and spreaders
	Terminal shields and interphase barriers
	Escutcheons
Dimensions (mm)	W x H x D
Weight (kg)	

Source Changeover System

Manual mechanical interlocking

[1] The thresholds for TMD and TMG 1-pole and 2-pole magnetic trip units up to 63 A are indicated for AC. The real DC thresholds are indicated on the following line.
 [2] Icu1: Rated individual pole ultimate short-circuit breaking capacity at phase-to neutral AC voltage introduced in IEC 60947-2:2024 For a 2P ComPacT NSX used on two lines of a 400Vac system, the breaking capacity in case of line to earth fault Icu1 is equal to Icu @400Vac.

Characteristics and Performance

ComPacT NSX Circuit Breakers from 100 to 250 A up to 690 V



NSX100			NSX160			NSX250		
1		2	1		2	1		
⊙		⊙	⊙		⊙	⊙		⊙
-		-	-		-	-		-
-		-	-		-	-		-
⊙		⊙	⊙		⊙	⊙		⊙
⊙		⊙	⊙		⊙	⊙		⊙
-		-	-		-	-		-
-		-	-		-	-		-
100		100	160		160	250		
750		750	750		750	750		
8		8	8		8	8		
277		690	277		690	277		
250		500	250		500	-		
F N M		F M S	F N M		F M S	N		
18 25 40		36 85 100	18 25 40		36 85 100	25		
- - -		18 25 70	- - -		18 25 70	-		
- - -		15 25 65	- - -		15 25 65	-		
- - -		10 18 35	- - -		10 18 35	-		
- - -		5 8 10	- - -		5 8 10	-		
36 50 85		36 85 100	36 50 85		36 85 100	-		
- - -		36 85 100	- - -		36 85 100	-		
100 %		100 %	100 %		100 %	100 %		
⊙		⊙	⊙		⊙	⊙		
20000		20000	20000		20000	10000		
20000		20000	20000		20000	10000		
10000		10000	10000		10000	5000		
built-in thermal-magnetic		built-in thermal-magnetic			built-in thermal-magnetic			built-in thermal-magnetic
16 20 25 30 40		50 63 80 100	125 160		160 200 250			160 200 250
fixed		fixed	fixed		fixed			fixed
16 20 25 30 40		50 63 80 100	125 160		160 200 250			160 200 250
fixed		fixed	fixed		fixed			fixed
190 190 300 300 500		500 500 640 800	1000 1250		850 850 850			850 850 850
260 260 400 400 700		700 700 800 1000	1200 1250		- - -			- - -
-		-	-		-			-
-		⊙	-		⊙			-
-		⊙	-		⊙			-
-		⊙	-		⊙			-
⊙		⊙	⊙		⊙			⊙
⊙		⊙	⊙		⊙			⊙
⊙		⊙	⊙		⊙			⊙
35 x 161 x 86		70 x 161 x 86	35 x 161 x 86		70 x 161 x 86			35 x 161 x 86
0.7		1.2	0.7		1.2			0.7
⊙		⊙	⊙		⊙			⊙

Characteristics and Performance

ComPacT NSX Circuit Breakers from 100 to 250 A up to 690 V

ComPacT New Generation Overview



ComPacT NSX250 HB2

Common characteristics

Rated voltages	Insulation voltage (V)	Ui	800
	Insulation voltage for ELCB [4]	Ui	500
	Insulation voltage device for current transformer and voltage output block (V)	Ui	690
	Impulse withstand voltage (kV)	Uimp	8
Operational voltage (V)	Ue	AC 50/60 Hz	690
	Operation voltage for ELCB [4]	Ue	AC 50/60 Hz 440
Suitability for isolation	IEC/EN 60947-2		yes
Utilization category			A
Pollution degree	IEC 60664-1		3
Connectivity	Compliant with IEC/EN 60947-2 Annex H		yes

Circuit breakers

Breaking Capacity Levels

Electrical characteristics as per IEC/EN 60947-2

Rated current (A)	I_n	40 °C
-------------------	-------	-------

Number of poles

Breaking capacity (kA rms)

$I_{cu} = I_{cu1}$ [5]	AC 50/60 Hz	220/240 V
		380/415 V
		440 V
		500 V
		525 V
		660/690 V

Service breaking capacity (kA rms)

I_{cs}	AC 50/60 Hz	220/240 V
		380/415 V
		440 V
		500 V
		525 V
		660/690 V

Durability (C-O cycles)

Mechanical

Electrical

440 V	$I_n/2$
	I_n
690 V	$I_n/2$
	I_n

Characteristics as per UL 60947-4-1

Breaking capacity (kA rms)	AC 50/60 Hz	240 V
		480 V
		600 V

Protection and Measurements

Short-circuit protection	Magnetic only
Overload/short-circuit protection	Thermal magnetic
	Electronic
	With neutral protection (Off-0.5-1-OSN) [1]
	With ground-fault protection
	With zone selective interlocking (ZSI) [2]

Display/I, U, f, P, E, THD measurements/interrupted-current measurement

Options	Power meter display on door
	Operating assistance
	Counters
	Histories and alarms
	Metering Com
	Device status/control Com

Earth-leakage protection

By VigiPacT add-on [3]

By VigiPacT relay

Installation/Connections

Dimensions and weights

Dimensions (mm)	Fixed, front connections	2/3P
	W x H x D	4P
Weight (kg)	Fixed, front connections	2/3P
		4P

Connections

Connection terminals	Pitch	With/without spreaders
Large Cu or Al cables	Cross-section	mm ²

Source-Changeover System

Manual mechanical interlocking

Automatic source-changeover

[1] OSN: Over Sized Neutral protection for neutrals carrying high currents (e.g. 3rd harmonics).

[2] ZSI: Zone Selective Interlocking using pilot wires.

[3] VigiPacT add-on is not available for breaking capacity levels HB1/HB2.

[4] Earth Leakage Circuit Breaker (MicroLogic Vigi 4.2 and 7.2 E).

[5] I_{cu1} : Rated individual pole ultimate short-circuit breaking capacity at phase-to neutral AC voltage introduced in IEC 60947-2:2024.

Characteristics and Performance

ComPacT NSX Circuit Breakers from 100 to 250 A up to 690 V

A

Common characteristics

Control	Manual	With toggle	<input checked="" type="radio"/>
		With direct or extended rotary handle	<input checked="" type="radio"/>
Versions	Electrical	With remote control	<input checked="" type="radio"/>
	Fixed		<input checked="" type="radio"/>
	Withdrawable	Plug-in base	<input checked="" type="radio"/>
		Chassis	<input checked="" type="radio"/>

NSX100									NSX160									NSX250											
B	F	N	H	S	L	R	HB1	HB2	B	F	N	H	S	L	R	HB1	HB2	B	F	N	H	S	L	R	HB1	HB2			
100						100			160						250						250								
2, 3, 4						3, 4			2, 3, 4						2, 3, 4						3, 4								
40	85	90	100	120	150	200	-	-	40	85	90	100	120	150	200	-	-	40	85	90	100	120	150	200	-	-	200	-	-
25	36	50	70	100	150	200	-	-	25	36	50	70	100	150	200	-	-	25	36	50	70	100	150	200	-	-	200	-	-
20	35	50	65	90	130	200	-	-	20	35	50	65	90	130	200	-	-	20	35	50	65	90	130	200	-	-	200	-	-
15	25	36	50	65	70	80	85	100	15	30	36	50	65	70	80	85	100	15	30	36	50	65	70	80	85	100	80	85	100
-	22	35	35	40	50	65	80	100	-	22	35	35	40	50	65	80	100	-	22	35	35	40	50	65	80	100	65	80	100
-	8	10	10	15	20	45	75	100	-	8	10	10	15	20	45	75	100	-	8	10	10	15	20	45	75	100	45	75	100
40	85	90	100	120	150	200	-	-	40	85	90	100	120	150	200	-	-	40	85	90	100	120	150	200	-	-	200	-	-
25	36	50	70	100	150	200	-	-	25	36	50	70	100	150	200	-	-	25	36	50	70	100	150	200	-	-	200	-	-
20	35	50	65	90	130	200	-	-	20	35	50	65	90	130	200	-	-	20	35	50	65	90	130	200	-	-	200	-	-
7	12	36	50	65	70	80	85	100	15	30	36	50	50	50	15	30	36	50	65	70	80	85	100	80	85	100			
-	11	35	35	40	50	65	80	100	-	22	35	35	35	35	65	80	100	-	22	35	35	40	50	65	80	100	65	80	100
-	4	10	10	10	10	45	75	100	-	8	10	10	10	10	45	75	100	-	8	10	10	10	10	45	75	100	45	75	100
50000						20000			40000						20000			20000						20000			20000		
50000						20000			40000						20000			20000						20000			20000		
30000						10000			20000						10000			10000						10000			10000		
20000						10000			15000						10000			10000						10000			10000		
10000						5000			7500						5000			5000						5000			5000		
-	85	85	85	-	-	-	-	-	-	85	85	85	-	-	-	-	-	-	85	85	85	-	-	-	-	-	-	-	-
-	25	50	65	-	-	-	-	-	-	35	50	65	-	-	-	-	-	-	35	50	65	-	-	-	-	-	-	-	-
-	10	10	10	-	-	-	-	-	-	10	10	10	-	-	-	-	-	-	15	15	15	-	-	-	-	-	-	-	-
<input checked="" type="radio"/>									<input checked="" type="radio"/>									<input checked="" type="radio"/>									<input checked="" type="radio"/>		
<input checked="" type="radio"/>									<input checked="" type="radio"/>									<input checked="" type="radio"/>									<input checked="" type="radio"/>		
<input checked="" type="radio"/>									<input checked="" type="radio"/>									<input checked="" type="radio"/>									<input checked="" type="radio"/>		
<input checked="" type="radio"/>									<input checked="" type="radio"/>									<input checked="" type="radio"/>									<input checked="" type="radio"/>		
<input checked="" type="radio"/>									<input checked="" type="radio"/>									<input checked="" type="radio"/>									<input checked="" type="radio"/>		
<input checked="" type="radio"/>									<input checked="" type="radio"/>									<input checked="" type="radio"/>									<input checked="" type="radio"/>		
<input checked="" type="radio"/>									<input checked="" type="radio"/>									<input checked="" type="radio"/>									<input checked="" type="radio"/>		
<input checked="" type="radio"/>									<input checked="" type="radio"/>									<input checked="" type="radio"/>									<input checked="" type="radio"/>		
<input checked="" type="radio"/>									<input checked="" type="radio"/>									<input checked="" type="radio"/>									<input checked="" type="radio"/>		
<input checked="" type="radio"/>									<input checked="" type="radio"/>									<input checked="" type="radio"/>									<input checked="" type="radio"/>		
<input checked="" type="radio"/>									<input checked="" type="radio"/>									<input checked="" type="radio"/>									<input checked="" type="radio"/>		
<input checked="" type="radio"/>									<input checked="" type="radio"/>									<input checked="" type="radio"/>									<input checked="" type="radio"/>		
<input checked="" type="radio"/>									<input checked="" type="radio"/>									<input checked="" type="radio"/>									<input checked="" type="radio"/>		
<input checked="" type="radio"/>									<input checked="" type="radio"/>									<input checked="" type="radio"/>									<input checked="" type="radio"/>		
<input checked="" type="radio"/>									<input checked="" type="radio"/>									<input checked="" type="radio"/>									<input checked="" type="radio"/>		
<input checked="" type="radio"/>									<input checked="" type="radio"/>									<input checked="" type="radio"/>									<input checked="" type="radio"/>		
105 x 161 x 86						105 x 161 x 86			105 x 161 x 86						105 x 161 x 86			105 x 161 x 86						105 x 161 x 86			105 x 161 x 86		
140 x 161 x 86						140 x 161 x 86			140 x 161 x 86						140 x 161 x 86			140 x 161 x 86						140 x 161 x 86			140 x 161 x 86		
2.05						2.4			2.2						2.4			2.4						2.4			2.4		
2.4						2.8			2.6						2.8			2.8						2.8			2.8		
35/45 mm						35/45 mm			35/45 mm						35/45 mm			35/45 mm						35/45 mm			35/45 mm		
300						300			300						300			300						300			300		
<input checked="" type="radio"/>									<input checked="" type="radio"/>									<input checked="" type="radio"/>									<input checked="" type="radio"/>		
<input checked="" type="radio"/>									<input checked="" type="radio"/>									<input checked="" type="radio"/>									<input checked="" type="radio"/>		

Characteristics and Performance

ComPacT NSX Circuit Breakers from 400 to 630 A up to 690 V



ComPacT NSX630 HB2

A

Common characteristics

Rated voltages	Insulation voltage (V)	Ui	800
	Insulation voltage for ELCB [4]		500
Insulation voltage device for Current Transformer and voltage output block (V)		Ui	690
	Impulse withstand voltage (kV)	Uimp	8
Operational voltage (V)		Ue AC 50/60 Hz	690
	Operation voltage for ELCB [4]	Ue AC 50/60 Hz	440
Suitability for isolation		IEC/EN 60947-2	yes
Utilization category			A
Pollution degree		IEC 60664-1	3

Circuit breakers

Breaking Capacity Levels

Electrical characteristics as per IEC/EN 60947-2

Rated current (A)	In	40 °C
Number of poles		

Breaking capacity (kA rms)

Icu	AC 50/60 Hz	220/240 V
		380/415 V
		440 V
		500 V
		525 V
		660/690 V
		660/690 V

Service breaking capacity (kA rms)

Ics	AC 50/60 Hz	220/240 V
		380/415 V
		440 V
		500 V
		525 V
		660/690 V
		660/690 V

Durability (C-O cycles)	Mechanical	440 V	In/2
			In
	Electrical	690 V	In/2
			In

Characteristics as per UL 60947-4-1

Breaking capacity (kA rms)	AC 50/60 Hz	240 V
		480 V
		600 V

Protection and Measurements

Short-circuit protection	Magnetic only
Overload/short-circuit protection	Thermal magnetic
	Electronic
	With neutral protection (Off-0.5-1-OSN) [1]
	With ground-fault protection
	With zone selective interlocking (ZSI) [2]

Display/I, U, f, P, E, THD measurements/interrupted-current measurement

Options	Power meter display on door
	Operating assistance
	Counters
	Histories and alarms
	Metering Com
	Device status/control Com
Earth-leakage protection	By VigiPacT add-on [3]
	By VigiPacT relay

Installation/Connections

Dimensions and weights

Dimensions (mm) W x H x D	Fixed, front connections	2/3P
		4P
Weight (kg)	Fixed, front connections	2/3P
		4P

Connections

Connection terminals	Pitch	With/without spreaders
Large Cu or Al cables	Cross-section	mm ²

Source-Changeover System

Manual mechanical interlocking
Automatic source-changeover

[1] OSN: Over Sized Neutral protection for neutrals carrying high currents (e.g. 3rd harmonics).

[2] ZSI: Zone Selective Interlocking using pilot wires.

[3] VigiPacT add-on is not available for breaking capacity levels HB1/HB2.

[4] Earth Leakage Circuit Breaker (MicroLogic Vigi 4.3 and 7.3 E)

Characteristics and Performance

ComPacT NSX Circuit Breakers from 400 to 630 A up to 690 V



Common characteristics

Control	Manual	With toggle	<input type="radio"/>
		With direct or extended rotary handle	<input type="radio"/>
	Electrical	With remote control	<input type="radio"/>
Versions	Fixed		<input type="radio"/>
	Withdrawable	Plug-in base	<input type="radio"/>
		Chassis	<input type="radio"/>

NSX400									NSX630									I _r = 225 - 500 A			I _r = 501 - 630 A		
F	N	H	S	L	R	HB1	HB2		F	N	H	S	L	R	HB1	HB2		R	HB1	HB2	R	HB1	HB2
400					400				630					630									
3, 4					3, 4				3, 4					3, 4									
40	85	100	120	150	200	-	-		40	85	100	120	150	200	-	-		200	-	-	200	-	-
36	50	70	100	150	200	-	-		36	50	70	100	150	200	-	-		200	-	-	200	-	-
30	42	65	90	130	200	-	-		30	42	65	90	130	200	-	-		200	-	-	200	-	-
25	30	50	65	70	80	85	100		25	30	50	65	70	80	85	100		80	85	100	80	85	100
20	22	35	40	50	65	80	100		20	22	35	40	50	65	80	100		65	80	100	65	80	100
10	10	20	25	35	45	75	100		10	10	20	25	35	45	75	100		45	75	100	45	75	100
40	85	100	120	150	200	-	-		40	85	100	120	150	200	-	-		200	-	-	200	-	-
36	50	70	100	150	200	-	-		36	50	70	100	150	200	-	-		200	-	-	200	-	-
30	42	65	90	130	200	-	-		30	42	65	90	130	200	-	-		200	-	-	200	-	-
25	30	50	65	70	80	85	100		25	30	50	65	70	80	85	100		80	85	100	80	85	100
10	11	11	12	12	65	80	100		10	11	11	12	12	65	80	100		65	80	100	16	20	25
10	10	10	12	12	45	75	100		10	10	10	12	12	45	75	100		45	75	100	12	19	25
15000					15000				15000					15000				15000			15000		
12000					12000				8000					8000				8000			8000		
6000					6000				4000					4000				4000			4000		
6000					6000				6000					6000				6000			6000		
3000					3000				2000					2000				2000			2000		
85	85	85	-	-	-	-	-		85	85	85	-	-	-	-	-		-	-	-	-	-	-
35	50	65	-	-	-	-	-		35	50	65	-	-	-	-	-		-	-	-	-	-	-
20	10	20	-	-	-	-	-		20	20	20	-	-	-	-	-		-	-	-	-	-	-

140 x 255 x 110	140 x 255 x 110
185 x 255 x 110	185 x 255 x 110
6.05	6.2
7.90	8.13
45/52.5 mm	45/52.5 mm
45/70 mm	45/70 mm
4 x 240	4 x 240

<input type="radio"/>	<input type="radio"/>
<input type="radio"/>	<input type="radio"/>

Characteristics and Performance

ComPacT NSXm Switch-Disconnectors from 50 to 160 A NA

Installation standards require upstream protection. However ComPacT NSXm 50 to 160 NA switch-disconnectors are self-protected by their high-set magnetic release.

A



ComPacT NSXm switch-disconnectors

Common characteristics

Rated voltages	Insulation voltage (V)	Ui	800
	Impulse withstand voltage (kV)	Uimp	8
	Operational voltage (V)	Ue	AC 50/60 Hz 690
Suitability for isolation		IEC/EN 60947-3	yes
Utilization category		AC 22 A/AC 23 A	
Pollution degree		IEC 60664-1	3

Switch-disconnectors

Electrical characteristics as per IEC/EN 60947-3

Conventional thermal current (A) I_{th} 40 °C

Number of poles

Operational current (A) depending on the utilization category	Ie	AC 50/60 Hz	220/240 V
			380/415 V
			440/480 V
			500/525 V
			660/690 V

Short-circuit making capacity (kA peak)	Icm	min. (switch-disconnector alone)	
		max. (protection by upstream circuit breaker)	

Rated short-time withstand current (A rms)	Icw	for	1 s
			3 s
			20 s

Durability (C-O cycles)	Mechanical	Electrical	AC	440 V	Ie/2	
				690 V	Ie	
					440 V	Ie/2
					690 V	Ie

Positive contact indication

Pollution degree

Additional indication and control auxiliaries

Indication contacts

Voltage releases	MX shunt trip release
	MN undervoltage release

Installation/connections

Dimensions and Weights

Dimensions (mm)	3P
W x H x D	4P
Weight (kg)	3P
	4P

Connections

Pitch (mm)	Standard
	With spreaders
EverLink lug Cu or Al [1] cables	Cross-section (mm ²)
	Rigid
Crimp lugs Cu or Al	Cross-section (mm ²)
	Flexible
	Rigid
	Flexible

Source-changeover systems

Manual mechanical interlocking

[1] Al up to 100 A.

Characteristics and Performance

ComPacT NSXm Switch-Disconnectors from 50 to 160 A NA



Common characteristics			
Control	Manual	With toggle	<input checked="" type="radio"/>
		With direct or extended rotary handle	<input checked="" type="radio"/>
		With side rotary handle	<input checked="" type="radio"/>
Versions	Fixed		<input checked="" type="radio"/>

	NSXm50NA	NSXm100NA	NSXm160NA
	50	100	160
	3, 4	3, 4	3, 4
	AC22A/AC23A	AC22A/AC23A	AC22A/AC23A
	50	100	160/100
	50	100	160/100
	50	100	160/100
	50	100	160/100
	50	100	160/100
	1.28	2.13	2.13
	150	150	150
	900	1500	1500
	900	1500	1500
	200	335	335
	20000	20000	20000
	AC22A/AC23A	AC22A/AC23A	AC22A/AC23A
	20000/20000	20000/20000	20000/20000
	10000/10000	10000/10000	10000/10000
	10000/6000	10000/6000	10000/6000
	5000/3000	5000/3000	5000/3000
	<input checked="" type="radio"/>	<input checked="" type="radio"/>	<input checked="" type="radio"/>
	3	3	3
	<input checked="" type="radio"/>	<input checked="" type="radio"/>	<input checked="" type="radio"/>
	<input checked="" type="radio"/>	<input checked="" type="radio"/>	<input checked="" type="radio"/>
	<input checked="" type="radio"/>	<input checked="" type="radio"/>	<input checked="" type="radio"/>
	81 x 137 x 80		
	108 x 137 x 80		
	1.06		
	1.42		
	27		
	35		
	95		
	70		
	120		
	95		
	<input checked="" type="radio"/>		

Characteristics and Performance

ComPacT NSX Switch-Disconnectors from 100 to 630 A NA

Installation standards require upstream protection. However ComPacT NSX100 to 630 NA switch-disconnectors are self-protected by their high-set magnetic release.

A



ComPacT NSX100 to 250 NA



ComPacT NSX400 to 630 NA

> Discover Schneider Electric specific switch-disconnectors offer: ComPacT INS/INV



LVPED213024EN

Common characteristics

Rated voltages	Insulation voltage (V)	Ui	800
	Impulse withstand voltage (kV)	Uimp	8
	Operational voltage (V)	Ue	AC 50/60 Hz 690
Suitability for isolation		IEC/EN 60947-3	yes
Utilization category		AC 22 A/AC 23 A - DC 22 A/DC 23 A	
Pollution degree		IEC 60664-1	3

Switch-disconnectors

Electrical characteristics as per IEC/EN 60947-3

Conventional thermal current (A)	Ith 50 °C		
Number of poles			
Operational current (A) depending on Ie the utilization category		AC 50/60 Hz	
			220/240 V
			380/415 V
			440/480 V
			500/525 V
			660/690 V
		DC	
			250 V (1 pole)
			500 V (2 poles in series)
			750 V (3 poles in series)
Short-circuit making capacity (kA peak)	Icm	Min. (switch-disconnector alone)	
		Max. (protection by upstream circuit breaker)	
Rated short-time withstand current (A rms)	Icw	for	1 s
			3 s
			20 s
Durability (C-O cycles)		Mechanical	
		Electrical	AC
			440 V
			In/2
			In
			690 V
			In/2
			In
		DC	250 V (1 pole) and In/2
			500 V (2 poles in series)In

Positive contact indication

Pollution degree

Protection

Add-on earth-leakage protection By VigiPacT add-on
By VigiPacT relay

Additional indication and control auxiliaries

Indication contacts

Voltages releases MX shunt release
MN undervoltage release

Current transformer module with voltage measurement
Insulation monitoring module

Remote communication by bus

Device-status indication
Device remote operation

Operation counter

Installation/connections

Dimensions (mm)	Fixed, front connections	2/3P
W x H x D		4P
Weight (kg)	Fixed, front connections	3P
		4P

Source-changeover systems (see chapter on Source-changeover systems)

Manual mechanical interlocking
Automatic source-changeover

[1] 2P in 3P case.

Characteristics and Performance

ComPacT NSX Switch-Disconnectors from 100 to 630 A NA



Common characteristics			
Control	Manual	With toggle	<input type="radio"/>
		With direct or extended rotary handle	<input checked="" type="radio"/>
	Electrical	With remote control	<input checked="" type="radio"/>
Versions	Fixed		<input checked="" type="radio"/>
	Withdrawable	Plug-in base	<input checked="" type="radio"/>
		Chassis	<input checked="" type="radio"/>

NSX100NA	NSX160NA	NSX250NA	NSX400NA	NSX630NA
100	160	250	400	630
2 [1], 3, 4	2 [1], 3, 4	2 [1], 3, 4	3, 4	3, 4
AC22A/AC23A	AC22A/AC23A	AC22A/AC23A	AC22A/AC23A	AC22A/AC23A
100	160	250	400	630
100	160	250	400	630
100	160	250	400	630
100	160	250	400	630
DC22A/DC23A	DC22A/DC23A	DC22A/DC23A	-	-
100	160	250	-	-
100	160	250	-	-
100	160	250	-	-
2.6	3.6	4.9	7.1	8.5
330	330	330	330	330
1800	2500	3500	5000	6000
1800	2500	3500	5000	6000
690	960	1350	1930	2320
50000	40000	20000	15000	15000
AC22A/AC23A	AC22A/AC23A	AC22A/AC23A	AC22A/AC23A	AC22A/AC23A
35000	30000	15000	10000	6000
20000	15000	7500	5000	3000
15000	10000	6000	5000	3000
8000	5000	3000	2500	1500
10000	10000	10000	-	-
5000	5000	5000	-	-
<input checked="" type="radio"/>	<input checked="" type="radio"/>	<input checked="" type="radio"/>	<input checked="" type="radio"/>	<input checked="" type="radio"/>
3	3	3	3	3
<input checked="" type="radio"/>			<input checked="" type="radio"/>	
<input checked="" type="radio"/>			<input checked="" type="radio"/>	
<input checked="" type="radio"/>			<input checked="" type="radio"/>	
<input checked="" type="radio"/>			<input checked="" type="radio"/>	
<input checked="" type="radio"/>			<input checked="" type="radio"/>	
<input checked="" type="radio"/>			<input checked="" type="radio"/>	
<input checked="" type="radio"/>			<input checked="" type="radio"/>	
<input checked="" type="radio"/>			<input checked="" type="radio"/>	
105 x 161 x 86			140 x 255 x 110	
140 x 161 x 86			185 x 255 x 110	
1.5 to 1.8			5.2	
2.0 to 2.2			6.8	
<input checked="" type="radio"/>			<input checked="" type="radio"/>	
<input checked="" type="radio"/>			<input checked="" type="radio"/>	

General Characteristics of the ComPacT Range

DB43277.ai

A	NSXm 160H		B
C	C12H3TM160L		E
D	Ui 800V	Uimp 8kV	F
	Ue(V)	Icu(kA)	Ics(kA)
	220-240 ~	100	100
	380-415 ~	70	70
	440 ~	65	65
G	50/60Hz	40°C	
	IEC/EN 60947-2	Cat A	

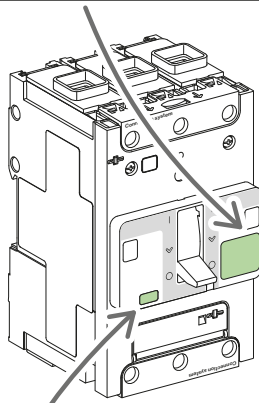

Ir(A) 63/160
In=60A

Standardized characteristics indicated on the rating plate:

- A** Type of device: frame size and breaking capacity class
- B** Circuit breaker/switch-disconnector symbol
- C** Commercial reference
- D** Ui: rated insulation voltage
- E** Uimp: rated impulse withstand voltage
- F** Ue: operational voltage
- G** Reference standard
- H** Circuit breaker rating

Note: When the circuit breaker is equipped with an extended rotary handle, the door must be opened to access the rating plate.

Compliance with Standards

ComPacT NSX and NSXm circuit breakers and switch-disconnectors comply with the following:

- International standards
 - IEC 60947-1: general rules
 - IEC 60947-2: circuit breakers
 - IEC 60947-3: switch-disconnectors
 - IEC 60947-5-1 and following: control circuit devices and switching elements; automatic control components
- European standards (EN 60947-1, EN 60947-2, EN 60947-3 and EN 60947-5-1)
- China CCC
- EAC (Customs Union)
- The specifications of the marine classification companies (Bureau Veritas, Lloyd's Register of Shipping, Det Norske Veritas, etc.), recommendations issued by the CNOMO organization.

Pollution Degree

ComPacT NSX and NSXm circuit breakers and switch-disconnectors are certified for operation in pollution degree 3 environments as defined by IEC standards 60947-1 and 60664-1 (industrial environments).

Climatic Withstand

ComPacT NSX and NSXm circuit breakers have successfully passed the tests defined by the following standards for extreme atmospheric conditions.

Dry cold and dry heat

- IEC 60068-2-1: dry cold at -55 °C
- IEC 60068-2-2: dry heat at +85 °C

Damp heat (tropicalization)

- IEC 60068-2-30: damp heat (temperature + 55 °C and relative humidity of 95 %)
- IEC 60068-2-52: severity 2 - Cycling salt mist

Environment

ComPacT NSX and NSXm respects the European environment directive 2011/65/EU (amendment 2015/863/EU) concerning the restriction of hazardous substances (RoHS) and enhanced transparency on our product environmental attributes for all products covering the full product life cycle through our Environmental Data Program.

Product environment profiles (PEP) have been prepared, describing the environmental impact of every product throughout its life cycle, from production to the end of its service life.

All ComPacT production sites have set up an environmental management system certified ISO 14001.

Each factory monitors the impact of its production processes. Every effort is made to prevent pollution and to reduce consumption of natural resources.

Ambient Temperature

- ComPacT NSX and NSXm circuit breakers may be used between -25 °C and +70 °C. For temperatures higher than 40 °C, (for ComPacT NSX: +65 °C for circuit breakers used to protect motor feeders) devices must be derated, [see pages E-8 to E-9 and E-13 to E-16](#).
- Circuit breakers should be put into service under normal ambient, operating-temperature conditions. Exceptionally, the circuit breaker may be put into service when the ambient temperature is between -35 °C and -25 °C.
- The permissible storage temperature range for ComPacT NSX and NSXm circuit breakers in the original packing is -50 °C ^[1] ^[2] and +85 °C.

[1] For ComPacT NSXm: - 40 °C for ComPacT NSXm MicroLogic Vigi 4.1.

[2] For ComPacT NSX: -40 °C for Micrologic Vigi 4, MicroLogic 5, MicroLogic 6 and MicroLogic Vigi 7.

Select Circuit Breakers and Switch-Disconnectors

General Characteristics of the ComPacT Range

Electromagnetic Compatibility

ComPacT NSX and NSXm devices are protected against:

- Overvoltages caused by circuit switching (e.g. lighting circuits)
- Overvoltages caused by atmospheric disturbances
- Devices emitting radio waves such as mobile telephones, radios, walkie-talkies, radar, etc.
- Electrostatic discharges produced by users.

Immunity levels for ComPacT NSXm comply with the standards below.

- IEC/EN 60947-2: Low-voltage switchgear and controlgear, part 2: Circuit breakers:
 - Annex F: Immunity tests for circuit breakers with electronic protection
 - Annex B: Immunity tests for residual current protection
- IEC/EN 61000-4-2: Electrostatic-discharge immunity tests
- IEC/EN 61000-4-3: Radiated, radio-frequency, electromagnetic-field immunity tests
- IEC/EN 61000-4-4: Electrical fast transient/burst immunity tests
- IEC/EN 61000-4-5: Surge immunity tests
- IEC/EN 61000-4-6: Immunity tests for conducted disturbances induced by radio-frequency fields
- IEC/EN 61000-4-8: Power frequency magnetic field immunity test
- IEC/EN 61000-4-11: Voltage dips, short interruptions and voltage variations immunity tests
- CISPR 11: Industrial, scientific and medical equipment - Radio-frequency disturbance characteristics - Limits and methods of measurement.

Suitable for Isolation with Positive Contact Indication

All ComPacT NSX and NSXm circuit-breakers and switch disconnectors are suitable for isolation as defined in IEC/EN 60947-2 for circuit breakers and IEC/EN 60947-3 for switch disconnectors:

Suitability for isolation tested according to IEC/EN 60947, is covering:

- The absence of dangerous leakage currents when contacts are open.
- Overvoltage withstand capacity between upstream and downstream connections when contacts are open.
- The effectiveness of the indication of the main contacts' position.

The "positive" contacts indication position is provided by the operating handle or motor mechanism in "O" (OFF) position:

- The operating handle or motor mechanism cannot indicate the OFF position unless all contacts are effectively open.
- Padlocks cannot be installed unless the contacts are open and operating handle or motor mechanism indicate OFF position.

Moreover, a trip indication is provided by the operating handle in "T" (TRIP) position:

- In TRIP position, the contacts are open and have the same distances as in OFF position, auxiliary contact indicates an OFF position.
- TRIP position of the operating handle indicates an opening caused by electrical fault, opening coil operation or push to trip test.
- Nevertheless, the TRIP position of the operating handle is not a "positive" contact indication of the open position and LOTO (Lock Out Tag Out) procedure shall be applied only in OFF position.

ComPacT NSX and NSXm equipped with tripping coil, are suitable for Emergency Switching-Off according to IEC/HD 60364-5-53 (CEI 64-8 art. 537.3.3).

Installation in Class II Switchboards

All ComPacT NSX and NSXm^[1] devices are class II front face devices. They may be installed through the door of class II switchboards (as per IEC standards 61140 and 60664-1) without downgrading switchboard insulation. Installation requires no special operations, even when the circuit breaker is equipped with a rotary handle or a motor mechanism.

Degree of Protection

The following indications are in accordance with standards IEC 60529 (IP degree of protection) and IEC 62262 (IK protection against external mechanical impacts).

Bare Circuit Breaker with Terminal Shields

- With toggle: IP40, IK07
- With direct rotary handle: IP40 IK07

Circuit Breaker Installed in a Switchboard

ComPacT NSXm

- With toggle: IP40, IK07
- With direct rotary handle: IP40, IK07
- With extended rotary handle: IP54 or IP65 IK08
- With side rotary handle: IP54 or IP65 IK08

ComPacT NSX

- With toggle: IP40, IK07
- With direct rotary handle:
 - Standard/VDE: IP40, IK07
 - MCC: IP43, IK07
 - CNOMO: IP54 IK08
- With extended rotary handle: IP55, IK08
- With motor mechanism: IP40, IK07

For more detail about IP, see [page E-7](#).

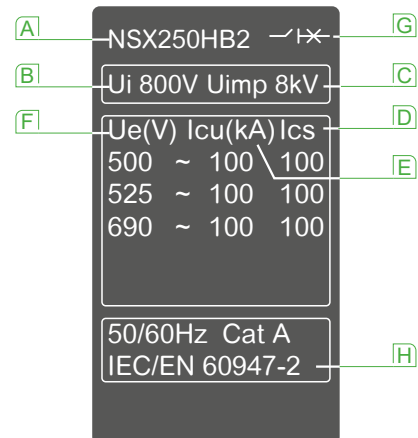

Standardized characteristics indicated on the rating plate:

- A** Type of device: frame size and breaking capacity class
- B** Ui: rated insulation voltage
- C** Uimp: rated impulse withstand voltage
- D** Ics: service breaking capacity
- E** Icu: ultimate breaking capacity for various values of the rated operational voltage Ue
- F** Ue: operational voltage
- G** Circuit breaker/switch-disconnector symbol
- H** Reference standard

Note: When the circuit breaker is equipped with an extended rotary handle, the door must be opened to access the rating plate.

[1] For operating voltages Ue > 440 V Class II front face is achieved with rotary handle only.

ComPacT NSX Special Applications

High Performance at 690 V

ComPacT NSX R/HB1/HB2 circuit breaker is designed specifically for the needs of systems operating at 690 V.

A



ComPacT NSX100 to 250



ComPacT NSX400 to 630

Markets

- Marine
- Oil and gas
- Data centers
- Other markets pursuing energy efficiency (water, industrial, etc.).

Ability to Service High Power Densities

- Upgrade voltage from ~415-440 to 690 V system allows:
 - Smaller cables can be used
 - Reduced cost and space
 - Reduced energy loss in transmission
 - Motors are more efficient at 690 V
- Consider 690 V as an alternative MV system:
 - Lower cost, smaller footprint, and improved maintenance.

Safety

IACS (International Association of Classification Societies) change, requires Ics rating for emergency systems:

- Key influence on Marine systems of high Ics ratings
- Continuity of service after 3 faults.

Technology

- Best in class technology and performance:
 - High breaking capacity
 - NSX family consistency of energy metering, alarming and diagnosis
- Provides alternative to fuse protection at 690 V applications.

Enhancing Solutions

- Using smaller frames for 690 V high performance circuits:
 - Space and cost benefit
 - NSX family consistency with same NSX accessories
- 200 kA breaking capacity on R rating will be mainly used for:
 - High power factor applications: around 2.8 instead of 2.2
 - Selectivity with MasterPact UR.

Type I & II Coordination for Motor Applications

- Type I & II coordination with TeSys contactors is available up to 690 V.
- Coordination tables are prepared with external overload relays and protection integrated into the MicroLogic trip units.
- See complementary bulletin for ratings.

Compliance with Standards

ComPacT NSX circuit breakers and auxiliaries comply with the following:

- International recommendations
 - IEC 60947-1: general rules
 - IEC 60947-2: circuit breakers
 - IEC 60947-3: switch-disconnectors
 - IEC 60947-5.1 and following: control circuit devices and switching elements; automatic control components
- European (EN 60947-1, EN 60947-2, EN 60947-3 and EN 60947-5.1) and corresponding national standards
- China CCC
- EAC (Customs Union)
- The specifications of the marine classification companies (Bureau Veritas, Lloyd's Register of Shipping, Det Norske Veritas, etc.), recommendations issued by the CNOMO organization for the protection of machine tools.

Special Applications and High Performance at 690 V

Contact Schneider Electric Customer Care Center for installation guidance.





Select Protection

Trip Unit Overview..... B-2

Protection of Distribution Systems

ComPacT NSXm TM Thermal-Magnetic Trip Units B-4

ComPacT NSX TM Thermal-Magnetic and MA Magnetic Trip Units B-6

Function Overview B-8

ComPacT NSXm + NSX Circuit Breakers Trip Units B-9

ComPacT NSX MicroLogic 2 and 1.3 Trip Units..... B-10

ComPacT NSX MicroLogic 5/6 E Trip Units..... B-12

Protection of Distribution Systems with Earth Leakage Protection B-14

ComPacT NSXm MicroLogic Vigi 4.1 Trip Unit..... B-17

ComPacT NSX MicroLogic Vigi 4 Trip Unit..... B-19

ComPacT NSX MicroLogic Vigi 7 E Trip Unit..... B-21

ComPacT NSX VigiPacT Add-on Protection Against Insulation Faults..... B-25

ComPacT NSX Motor Protection

General Information on Motor Feeders B-29

Motor-Feeder Characteristics and Solutions B-31

Motor-Feeder Solutions..... B-32

MA Instantaneous Trip Units B-33

MicroLogic 1.3 M Instantaneous Trip Units B-34

MicroLogic 2.2/2.3 M Electronic Trip Units..... B-35

MicroLogic 6 E-M Electronic Trip Units B-37

ComPacT NSX Measurement

MicroLogic 5/6/7 E Electronic Trip Units..... B-41

ComPacT NSX Diagnostics & Maintenance

MicroLogic 5/6/7 E Electronic Trip Units..... B-45

ComPacT NSX Special Applications

Protection of Public Distribution Systems with MicroLogic 2-AB . B-48

ComPacT NSX MicroLogic Vigi 4-AB Trip Unit with Embedded Earth Leakage Protection B-51

Generator Protection with MicroLogic 2.2 G..... B-53

Protection of Industrial Control Panels B-55

16 Hz 2/3 Network Protection - MicroLogic 5 A-Z Trip Unit B-57

Protection of 400 Hz Systems B-58

ComPacT NSX400K at 1000 V AC B-61



Other Chapters

Select Circuit Breakers and Switch-Disconnectors A-1

Customize Circuit Breakers with Accessories..... C-1

Smart Panel Integration D-1

Switchboard Integration..... E-1

Catalog Numbers F-1

Glossary G-1

Additional Characteristics..... H-1

Select Protection Trip Unit Overview

ComPacT NSXm has a built-in trip unit.

B

	ComPacT NSXm up to 160 A	ComPacT NSX up to 250 A	ComPacT NSX 400 to 630 A
	 C12H3TM160L.eps  C12H4V160L.eps	 C25V3MA250.eps  C25V3TM250.eps	 C40F3TM4001.eps
	TM-D Distribution MicroLogic Vigi 4.1 Distribution and Earth Leakage Protection	MA Distribution and Motors TM-D Distribution TM-G Generators	TM-D Distribution

Protections	LI	LS ₀ IR	I	LI	LI
Standard protections					
Settings and indications	Pick-up set in amps using dials Non-adjustable time delay				
Front indication	●	●	●	●	●
Test connector		●			
Self test	●	●	●	●	●
Measurements					
Embedded measurements ^[1]					
Diagnostic & Maintenance					
Status indication	●	●	●	●	●
Operating assistance					
Control					
Voltage release	●	●	●	●	●
Motor mechanism			●	●	●
Communication					
Modbus SL					
Ethernet					
Local display					
Input/Output control					
SDx		●			
I/O module			●	●	●
Earth Leakage					
Embedded protection		●			
VigiPacT add-on module			●	●	●
VigiPacT relay	●		●	●	●

[1] For more details, refer to page B-44.

ComPacT NSX offers a range of trip units in interchangeable cases, whether they are magnetic, thermal-magnetic or electronic. Versions 5 and 6 of the electronic trip unit offer communication and metering. Using MicroLogic sensors and intelligence, ComPacT NSX supplies all the information required to manage the electrical installation and optimize energy use.

ComPacT NSX up to 630 A



MicroLogic 2 and 1.3 100-250 A 400-630 A		MicroLogic 4 100-250 A 400-630 A		MicroLogic 5 and 6 100-250 A 400-630 A		MicroLogic 7 100-250 A 400-630 A	
Distribution		Distribution and earth-leakage protection		Distribution and generators		Distribution and earth-leakage protection	
2.2	2.3	2.2	2.3	5.2 E/6.2 E	5.3 E/6.3 E	7.2 E	7.3 E
Service connection utilities		Service connection utilities		Motors		7.2 EAL	7.3 EAL
2.2 AB	2.3 AB	4.2 AB	4.3 AB	6.2 E-M	6.3 E-M		
Motors		4.2 AL	4.3 AL				
2.2 M	1.3 M/2.3 M						
Generators							
2.2 G	2.3 G						
2.2 G	2.3 G						

	LS ₀ I	LS ₀ IR	LSI, LSIG	LSIR
Pick-up set in amps using dials	●	●	●	●
Non-adjustable time delay	●	●	●	●
	●	●	●	●
			●	●
	●	●	●	●
			●	●
	●	●	●	●
	●	●	●	●
			●	●
	●	●	●	●
	●	●	●	●
		●		●
	●		●	
	●		●	

B

Protection of Distribution Systems

ComPacT NSXm TM Thermal-Magnetic Trip Units

ComPacT NSXm has a built-in thermal magnetic trip unit.



ComPacT NSXm 160

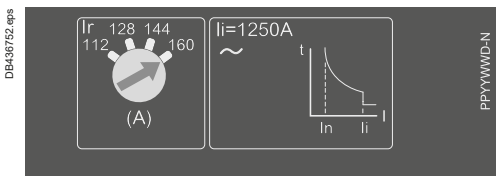

B

TM-D Thermal-Magnetic Trip Units

Circuit breakers equipped with thermal-magnetic trip units are used mainly in industrial and commercial electrical distribution applications for protection of cables on distribution systems supplied by transformers.

Protection

L Thermal Protection (Ir)

Thermal overload protection based on a bimetal strip providing an inverse time curve I^2t , corresponding to a temperature rise limit. Above this limit, the deformation of the strip trips the circuit breaker operating mechanism.

This protection operates according to:

- Ir that can be adjusted in amps from 0.7 to 1 times the rating of the circuit breaker (16 A to 160 A), corresponding to settings from 11 to 160 A for the range of products
- A non-adjustable time delay for cable protection.

I Magnetic Protection (Ii)

Short-circuit protection with a fixed pick-up Ii that initiates instantaneous tripping if exceeded with a non-adjustable time delay for selectivity and cascading.

Protection Versions

- 3-pole:
 - 3P 3D: 3-pole frame (3P) with detection on all 3 poles (3D)
- 4-pole:
 - 4P 3D: 4-pole frame (4P) with detection on 3 poles (3D)
 - 4P 4D: 4-pole frame (4P) with detection on all 4 poles (same threshold for phases and neutral).

Note: All the circuit breakers have a transparent lead-sealable cover that avoids access to the adjustment dials.

Protection of Distribution Systems

ComPacT NSXm TM Thermal-Magnetic Trip Units

Thermal-Magnetic Trip Units TM16D to 160D

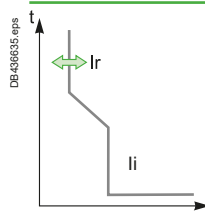

Ratings (A)	In at 40 °C ^[1]	16	25	32	40	50	63	80	100	125	160
Circuit breaker	ComPacT NSXm	<input checked="" type="radio"/>	<input checked="" type="radio"/>	<input checked="" type="radio"/>	<input checked="" type="radio"/>	<input checked="" type="radio"/>	<input checked="" type="radio"/>	<input checked="" type="radio"/>	<input checked="" type="radio"/>	<input checked="" type="radio"/>	<input checked="" type="radio"/>
L Thermal protection											
Pick-up (A) tripping between 1.05 and 1.20 Ir	Ir = In x ...	Adjustable in amps from 0.7 to 1 x In									
Time delay (s)	tr	Non-adjustable									
I Magnetic protection											
Pick-up (A)	Ii	Fixed									
accuracy ±20 %	ComPacT NSXm	500	600	600	600	600	800	1000	1250	1250	1250
Time delay	tm	Fixed									
Neutral protection											
Unprotected neutral	4P 3D	No detection									
Fully protected neutral	4P 4D	1 x Ir									

[1] If the circuit breakers are used in high-temperature environments, the setting must take into account the thermal limitations of the circuit breaker. See the temperature derating table.



Protection of Distribution Systems

ComPacT NSX TM Thermal-Magnetic and MA Magnetic Trip Units

TM MA magnetic trip units can be used on ComPacT NSX100/160/250/400/630 circuit breakers with performance levels B/F/N/H/S/L. TM thermal magnetic trip units are available in 2 versions:

- TM-D, for the protection of distribution cables (performance B/F/N/H/S/L for 100 to 250 and F/N/H for 400 to 630)
- TM-G, with a low threshold, for the protection of generators or long cable lengths (for 100 to 250)

DB438753.ai



B

C25W3TM250_1_eps



ComPacT NSX250 F

DB438754.ai

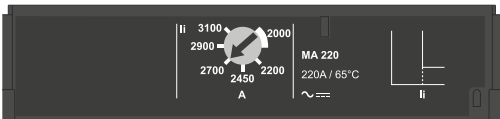

TM-D and TM-G Thermal-Magnetic Trip Units

Circuit breakers equipped with thermal-magnetic trip units are used mainly in industrial and commercial electrical distribution applications:

- TM-D, for protection of cables on distribution systems supplied by transformers
- TM-G, with a low pick-up for generators (lower short-circuit currents than with transformers) and distribution systems with long cable lengths (fault currents limited by the resistance of the cable).

Protection

L Thermal Protection (Ir)

Thermal overload protection based on a bimetal strip providing an inverse time curve I^2t , corresponding to a temperature rise limit. Above this limit, the deformation of the strip trips the circuit breaker operating mechanism.

This protection operates according to:

- Ir that can be adjusted in amps from 0.7 to 1 times the rating of the trip unit (16 A to 630 A), corresponding to settings from 11 to 250 A and 400 to 630 A for the range of trip units
- A non-adjustable time delay for cable protection.

I Magnetic Protection (Ii)

Short-circuit protection with a fixed or adjustable pick-up Ii that initiates instantaneous tripping if exceeded.

- TM-D: fixed pick-up, Ii, for 16 to 160 A ratings and adjustable from 5 to 10 x In for 200 and 250 A ratings and 400 to 630 A ratings.
- TM-G: fixed pick-up for 16 to 250 A ratings.

Protection against insulation faults

Two solutions are possible by adding:

- A VigiPacT add-on acting directly on the trip unit of the circuit breaker
- A VigiPacT relay connected to an MN or MX voltage release.

Protection Versions

- 3-pole: 3P 3D: 3-pole frame (3P) with detection on all 3 poles (3D)
- 4-pole:
 - 4P 3D: 4-pole frame (4P) with detection on 3 poles (3D)
 - 4P 4D: 4-pole frame (4P) with detection on all 4 poles (same threshold for phases and neutral).

MA Magnetic Trip Units

In distribution applications, circuit breakers equipped with MA magnetic-only trip units are used for:

- Short-circuit protection of secondary windings of LV/LV transformers with overload protection on the primary side
- As an alternative to a switch-disconnector at the head of a switchboard in order to provide short-circuit protection.

Their main use is however for motor protection applications, in conjunction with a thermal relay and a contactor or motor starter.

Protection

I Magnetic Protection (Ii)

Short-circuit protection with an adjustable pick-up Ii that initiates instantaneous tripping if exceeded.

- Ii = In x ... set in amps on an adjustment dial  covering the range 6 to 14 x In for 2.5 to 100 A ratings or 9 to 14 In for 150 to 220 A ratings.

Protection Versions

- 3-pole (3P 3D): 3-pole frame (3P) with detection on all 3 poles (3D)
- 4-pole (4P 3D): 4-pole frame (4P) with detection on 3 poles (3D)

Note: All the trip units have a transparent lead-sealable cover that avoids access to the adjustment dials.

Protection of Distribution Systems

ComPacT NSX TM Thermal-Magnetic and MA Magnetic Trip Units

Thermal-Magnetic Trip Units TM16D to 630D

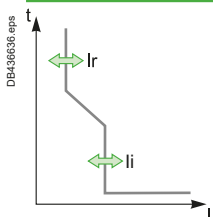

Ratings (A)	In at 40 °C [1]	16	25	32	40	50	63	80	100	125	160	200	250	400	630
Circuit breaker	ComPacT NSX100	●	●	●	●	●	●	●	●	-	-	-	-	-	-
	ComPacT NSX160	-	-	●	●	●	●	●	●	●	●	-	-	-	-
	ComPacT NSX250	-	-	-	-	-	●	●	●	●	●	●	●	-	-
	ComPacT NSX400	-	-	-	-	-	-	-	-	-	-	-	-	●	-
	ComPacT NSX630	-	-	-	-	-	-	-	-	-	-	-	-	-	●

L Thermal protection		
Pick-up (A) tripping between 1.05 and 1.20 Ir	Ir = In x ...	Adjustable in amps from 0.7 to 1 x In
Time delay (s)	tr	Non-adjustable
	tr at 1.5 x In	120 to 400
	tr at 6 x Ir	15

I Magnetic protection		
Pick-up (A) accuracy ±20 %	Ii	Fixed
	ComPacT NSX100	190 300 400 500 500 500 640 800
	ComPacT NSX160/250	190 300 400 500 500 500 640 800 1250 1250
Time delay	tm	Fixed
		Adjustable
		5 to 10xIn

Neutral protection		
Unprotected neutral	4P 3D	No detection
Fully protected neutral	4P 4D	1 x Ir

B

Thermal-Magnetic Trip Units TM16G to 250G

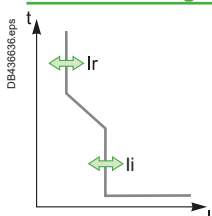

Ratings (A)	In at 40 °C [1]	16	25	40	63	80	100	125	160	200	250
Circuit breaker	ComPacT NSX100	●	●	●	●	●	●	-	-	-	-
	ComPacT NSX160	-	●	●	●	●	●	●	●	-	-
	ComPacT NSX250	-	-	-	-	-	-	-	●	●	●

L Thermal protection		
Pick-up (A) tripping between 1.05 and 1.20 Ir	Ir = In x ...	Adjustable in amps from 0.7 to 1 x In
Time delay (s)	tr	Non-adjustable
	tr at 1.5 x In	120 to 400
	tr at 6 x Ir	-

I Magnetic protection		
Pick-up (A) accuracy ±20 %	Ii	Fixed
	ComPacT NSX100	63 80 80 125 200 320 - - - -
	ComPacT NSX160	- 80 80 125 200 320 440 440 - -
	ComPacT NSX250	- - - - - - - 440 440 520
Time delay	tm	Fixed

Neutral protection		
Unprotected neutral	4P 3D	No
Fully protected neutral	4P 4D	1 x Ir

[1] For temperatures greater than 40 °C, the thermal protection characteristics are modified. See the temperature derating table.

Magnetic Trip Units MA 2.5 to 220

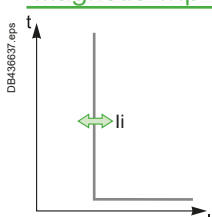

Ratings (A)	In at 65 °C [1]	2.5	6.3	12.5	25	50	100 [1]	150	220
Circuit breaker	ComPacT NSX100	●	●	●	●	●	●	-	-
	ComPacT NSX160	-	-	-	●	●	●	●	-
	ComPacT NSX250	-	-	-	-	-	●	●	●

I Instantaneous magnetic protection		
Pick-up (A) accuracy ±20 %	Ii = In x ...	Adjustable from 6 to 14 x In (settings 6, 7, 8, 9, 10, 11, 12, 13, 14)
		Adjustable from 9 to 14 x In (settings 9, 10, 11, 12, 13, 14)
Time delay (ms)	tm	Fixed

[1] MA100 3P adjustable from 6 to 14 x In. MA100 4P adjustable from 9 to 14 x In.

Note: All the trip units have a transparent lead-sealable cover that avoids access to the adjustment dials.

Protection of Distribution Systems

Function Overview

Measurement

Energy management is the challenge of present and future generations. To meet this requirement, MicroLogic E **incorporates all the measuring functions** of a power meter.

Protection

MicroLogic 5 (LSI), 6 (LSIG) and 7 (LSIR) offer a large long time delay setting range (0.4 to 1 xIn) and **protection accuracy for a wide temperature range** (-25 to +70 °C).

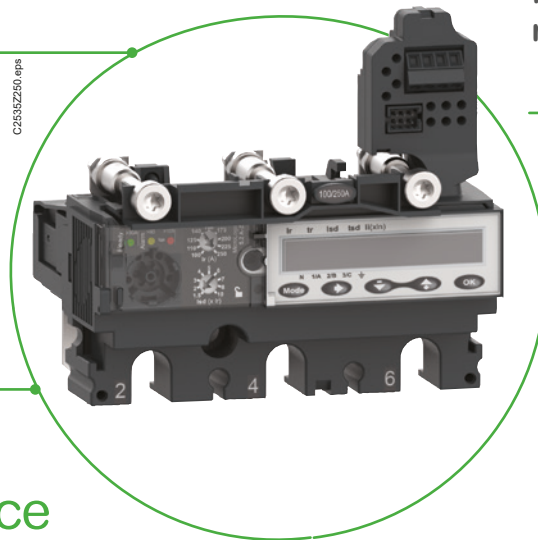

Diagnostics and Maintenance

Customers expect maximum service continuity and long-lasting equipment performance. MicroLogic E trip units deliver on this promise by enabling smart corrective, preventive, and predictive maintenance. The **green 'Ready' LED** reinforces this reliability by continuously monitoring the measurement chain and the tripping release. When the LED flashes, it confirms that the circuit breaker is ready to protect. This provides continuous peace of mind with no test kit required.





Communication

Protection Control Unit, provides local information for network operation and maintenance, as well as remote information for higher functions of control, monitoring, energy efficiency and assets management. To comply with those requirements MicroLogic trip unit and Enerlin'X communication system provides **access to status, electrical values and devices control** using Ethernet and Modbus SL communication protocols.

B

Protection of Distribution Systems

ComPacT NSXm + NSX Circuit Breakers Trip Units

Understanding the names of MicroLogic electronic trip units				
Example: MicroLogic 6.3 E-M	6	3	E	M
	Protection	Frame	Measurements	Applications
	<ul style="list-style-type: none"> • • • • • 	<ul style="list-style-type: none"> • • • • • 	<ul style="list-style-type: none"> • • • • • 	<ul style="list-style-type: none"> • • • • •
	▼	▼	▼	▼
	<p>1: I</p> <p>2: LS₀I</p> <p>4: LS₀IR</p> <p>5: LSI</p> <p>6: LSIG</p> <p>7: LSIR</p> <p>I: Instantaneous</p> <p>L: Long time</p> <p>R: Residual current</p> <p>S₀: Short time ^[2] (fixed delay)</p> <p>S: Short time</p> <p>G: Ground fault</p>	<p>1: NSXm 16 to 160</p>  <p>2: NSX 100/160/250</p>  <p>3: NSX 400/630</p> 	<p>E: Energy</p> 	<p>Distribution, otherwise</p> <p>G: Generator</p> <p>AB: Public distribution ^[1]</p> <p>M: Motors</p> <p>Z: 16 Hz 2/3 ^[1]</p>
	<ul style="list-style-type: none"> • • • • • 	<ul style="list-style-type: none"> • • • • • 	<ul style="list-style-type: none"> • • • • • 	<ul style="list-style-type: none"> • • • • •
	▼	▼	▼	▼
Examples				
MicroLogic 1.3	Instantaneous only	400 or 630 A	-	Distribution
MicroLogic 2.3	LS ₀ I	400 or 630 A	-	Distribution
MicroLogic Vigi 4.1	LS ₀ IR	16 to 160 A	-	Distribution
MicroLogic 5.2 E	LSI	100, 160 or 250 A	Energy	Distribution
MicroLogic 6.3 E-M	LSIG	400 or 630 A	Energy	Motor
MicroLogic 4.2	LS ₀ IR	100, 160 or 250 A	-	Distribution
MicroLogic 7.3	LSIR	400 or 630 A	Energy	Distribution

[1] AB-Z: except NSXm and NSX R, HB1, HB2.

[2] LS₀I protection is standard on MicroLogic 2. To allow selectivity, it offers short-time protection S₀ with a non-adjustable delay and instantaneous protection.

Select Protection

Protection of Distribution Systems

ComPacT NSX MicroLogic 2 and 1.3 Trip Units

MicroLogic 2 trip units can be used on ComPacT NSX100 to 630 circuit breakers with performance levels B/F/N/H/S/L/R/HB1/HB2.

They provide:

- Standard protection of distribution cables
- Indication of:
 - Overloads (via LEDs)
 - Overload tripping (via the SDx relay module).

B

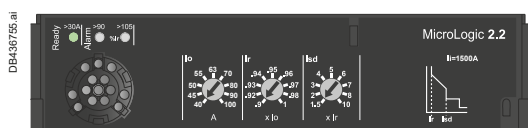

SDx remote indication relay module with its terminal block

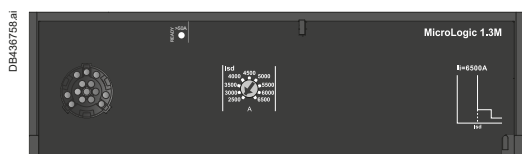

MicroLogic 2

Circuit breakers equipped with MicroLogic 2 trip units can be used to protect distribution systems supplied by transformers. For generators and long cables, MicroLogic 2 G trip units offer better suited low pick-up solutions (see page B-53).

Protection

Settings are made using the adjustment dials with fine adjustment possibilities.

L Overloads: Long Time Protection (I_r)

Inverse time protection against overloads with an adjustable current pick-up I_r set using a dial and a non-adjustable time delay t_r.

S Short-Circuits: Short-Time Protection with Fixed Time Delay (I_{sd})

Protection with an adjustable pick-up I_{sd}. Tripping takes place after a very short delay used to allow selectivity with the downstream device.

I Short-Circuits: Non-Adjustable Instantaneous Protection

Instantaneous short-circuit protection with a fixed pick-up.

Neutral Protection

- On 3-pole circuit breakers, neutral protection is not possible.
- On four-pole circuit breakers, neutral protection may be set using a three-position switch:
 - 4P 3D: neutral unprotected
 - 4P 3D + N/2: neutral protection at half the value of the phase pick-up, i.e. 0.5 x I_r
 - 4P 4D: neutral fully protected at I_r.

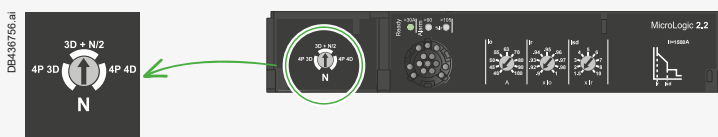

Indications

Front Indications

- Green "Ready" LED: the MicroLogic current transformer is continuously monitored by automatic tests. The blinking green "Ready" LED indicates that protection links—from CTs to electronics to the minitop release—are fully operational with no test kit required. This feature works from 15 to 50 A, depending on the device. For lower loads, a pocket battery can be used to activate the indication.
- Orange overload pre-alarm LED: steady on when I > 90 % I_r.
- Red overload LED: steady on when I > 105 % I_r.

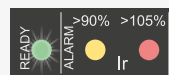

Remote Indications

An overload trip signal can be remotely installed by installing an SDx relay module inside the circuit breaker.

This module receives the signal from the MicroLogic electronic trip unit via an optical link and makes it available on the terminal block. The signal is cleared when the circuit breaker is reclosed. For more information, see page C-32.

MicroLogic 1.3 M for Magnetic Protection Only

MicroLogic 1.3 M trip units provide magnetic protection only, using electronic technology. They are dedicated to 400/630 A 3-poles (3P 3D) circuit breakers or 4-pole circuit breakers with detection on 3 poles (4P, 3D) and are used in certain applications to replace switch-disconnectors at the head of switchboards. They are especially used in 3-poles versions for motor protection, see page B-33.

Note: All the trip units have a transparent lead-sealable cover that avoids access to the adjustment dials.

Protection of Distribution Systems

ComPacT NSX MicroLogic 2 and 1.3 Trip Units

B

MicroLogic 2

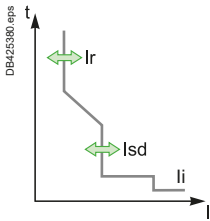

Ratings (A)	In at 40 °C [1]	40	100	160	250	400	630
Circuit breaker	ComPacT NSX100	●	●	-	-	-	-
	ComPacT NSX160	●	●	●	-	-	-
	ComPacT NSX250	●	●	●	●	-	-
	ComPacT NSX400	-	-	-	●	●	-
	ComPacT NSX630	-	-	-	●	●	●

L Long-time protection

Pick-up (A) tripping between 1.05 and 1.20 Ir	lo	Value depending on trip unit rating (In) and setting on dial								
In = 40 A	lo =	18	18	20	23	25	28	32	36	40
In = 100 A	lo =	40	45	50	55	63	70	80	90	100
In = 160 A	lo =	63	70	80	90	100	110	125	150	160
In = 250 A (NSX250)	lo =	100	110	125	140	160	175	200	225	250
In = 250 A (NSX400)	lo =	70	100	125	140	160	175	200	225	250
In = 400 A	lo =	160	180	200	230	250	280	320	360	400
In = 630 A	lo =	250	280	320	350	400	450	500	570	630

Time delay (s)	tr	Non-adjustable								
accuracy 0 to -30%	1.5 x Ir	400								
accuracy 0 to -20%	6 x Ir	16								
accuracy 0 to -20%	7.2 x Ir	11								

Thermal memory 20 minutes before and after tripping

S0 Short-time protection with fixed time delay

Pick-up (A) accuracy ±10 %	Isd = Ir x ...	1.5	2	3	4	5	6	7	8	10
Time delay (ms)	tsd	Non-adjustable								
	Non-tripping time	20								
	Maximum break time	80								

I Instantaneous protection

Pick-up (A) accuracy ±15 %	Ii non-adjustable	600	1500	2400	3000	4800	6900
	Non-tripping time	10 ms					
	Maximum break time	50ms if the current I > 1.5 x Ii					

[1] If the trip units are used in high-temperature environments, the MicroLogic setting must take into account the thermal limitations of the circuit breaker. See the temperature derating table.

MicroLogic 1.3 M

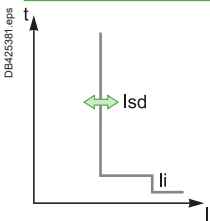

Ratings (A)	In at 65 °C [1]	320	500
Circuit breaker	ComPacT NSX400	●	-
	ComPacT NSX630	●	●

S Short-time protection

Pick-up (A) accuracy ±15 %	Isd	Adjustable directly in amps	
		9 settings: 1600, 1920, 2240, 2560, 2880, 3200, 3520, 3840, 4160 A	9 settings: 2500, 3000, 3500, 4000, 4500, 5000, 5500, 6000, 6500 A
Time delay (ms)	tsd	Non-adjustable	
	Non-tripping time	10	
	Maximum break time	60	

I Instantaneous protection

Pick-up (A) accuracy ±15 %	Ii non-adjustable	4800	6500
	Non-tripping time	0	
	Maximum break time	30 ms	

[1] Motor standards require operation at 65 °C. Circuit-breaker ratings are derated to take this requirement into account.

Select Protection

Protection of Distribution Systems

ComPacT NSX MicroLogic 5/6 E Trip Units

MicroLogic 5/6 E (Energy) trip units can be used on ComPacT NSX100 to 630 circuit breakers with performance levels B/F/N/H/N/S/L/R/HB1/HB2. They all have a display unit. They offer basic LSI protection (MicroLogic 5) or LSI and ground-fault protection G (MicroLogic 6). They also offer measurement, alarm and communication functions.

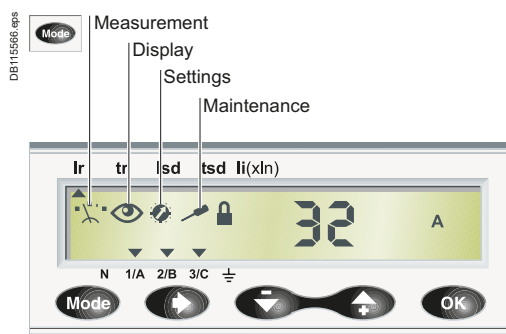
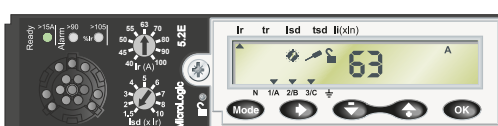

Trip unit menus

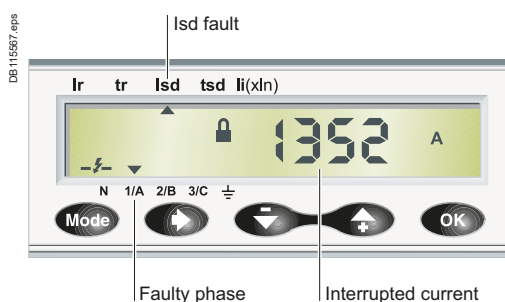

Display of interrupted current

Protection

Settings can be adjusted in two ways, using the dials and/or the keypad. The keypad can be used to make fine adjustments in 1 A steps below the maximum value defined by the setting on the dial. Access to setting modifications via the keypad is protected by a locking function displayed on the screen and controlled by a microswitch. The lock is activated automatically if the keypad is not used for 5 minutes. Access to the microswitch is protected by a transparent lead-sealable cover. With the cover closed, it is still possible to display the various settings and measurements using the keypad.

L Overloads: Long Time Protection (Ir)

Inverse time protection against overloads with an adjustable current pick-up I_r set using a dial or the keypad for fine adjustments. The time delay tr is set using the keypad.

S Short-Circuits: Short-Time Protection (Isd)

Short-circuit protection with an adjustable pick-up I_{sd} and adjustable time delay tsd , with the possibility of including a portion of an inverse time curve (I^2t On).

I Short-Circuits: Instantaneous Protection (Ii)

Instantaneous protection with adjustable pick-up I_i .

G Ground Fault Protection (I_g) on MicroLogic 6

Residual type ground-fault protection with an adjustable pick-up I_g (with Off position) and adjustable time delay tg . Possibility of including a portion of an inverse time curve (I^2t On).

Neutral Protection

On 4-pole circuit breakers, this protection can be set via the keypad:

- Off: neutral unprotected
- 0.5: neutral protection at half the value of the phase pick-up, i.e. $0.5 \times I_r$
- 1.0: neutral fully protected at I_r
- OSN: Oversized neutral protection at 1.6 times the value of the phase pick-up. Used when there is a high level of 3rd order harmonics (or orders that are multiples of 3) that accumulate in the neutral and create a high current. In this case, the device must be limited to $I_r = 0.63 \times I_n$ for the maximum neutral protection setting of $1.6 \times I_r$.

With 3-pole circuit breakers, the neutral can be protected as an option by installing an external neutral sensor with the output (T1, T2) connected to the trip unit.

Zone Selective Interlocking (ZSI)

A ZSI terminal block may be used to interconnect a number of MicroLogic control units to provide zone selective interlocking for short-time (I_{sd}) and ground-fault (I_g) protection, without a time delay. For ComPacT NSX 100 to 250, the ZSI function is available only in relation to the upstream circuit breaker (ZSI out).

Display of Type of Fault

On a fault trip, the type of fault (I_r , I_{sd} , I_i , I_g), the phase concerned and the interrupted current are displayed. An external power supply is required.

Indications

Front Indications

- Green "Ready" LED: the MicroLogic current transformer is continuously monitored by automatic tests. The MicroLogic will trip if the current transformer malfunctions. The blinking green "Ready" LED indicates that protection links—from CTs to electronics to the minitop release—are fully operational with no test kit required. This feature works from 15 to 50 A, depending on the device. For lower loads, a pocket battery can be used to activate the indication.
- Orange overload pre-alarm LED: steady on when $I > 90\% I_r$.
- Red overload LED: steady on when $I > 105\% I_r$.

Remote Indications

An SDx relay module installed inside the circuit breaker can be used to remotely access to the following information:

- Overload trip
- Overload prealarm (MicroLogic 5) or ground fault trip (MicroLogic 6).

This module receives the signal from the MicroLogic electronic trip unit via an optical link and makes it available on the terminal block. The signal is cleared when the circuit breaker is closed.

These outputs can be reprogrammed to be assigned to other types of tripping or alarm. The module is described in detail in the section dealing with accessories.

Note: All the trip units have a transparent lead-sealable cover that avoids access to the adjustment dials.

Protection of Distribution Systems

ComPacT NSX MicroLogic 5/6 E Trip Units

MicroLogic 5/6 E Trip Units

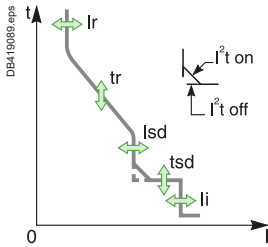

Ratings (A)	In at 40 °C [1]	40 [2]	100	160	250	400	630
Circuit breaker	ComPacT NSX100	●	●	-	-	-	-
	ComPacT NSX160	●	●	●	-	-	-
	ComPacT NSX250	●	●	●	●	-	-
	ComPacT NSX400	-	-	-	-	●	-
	ComPacT NSX630	-	-	-	-	●	●

L Long-time protection

Pick-up (A) tripping between 1.05 and 1.20 Ir	Ir = ...	Dial setting	Value depending on trip unit rating (In) and setting on dial														
	In = 40 A	lo =	18	18	20	23	25	28	32	36	40						
	In = 100 A	lo =	40	45	50	55	63	70	80	90	100						
	In = 160 A	lo =	63	70	80	90	100	110	125	150	160						
	In = 250 A	lo =	100	110	125	140	160	175	200	225	250						
	In = 400 A	lo =	160	180	200	230	250	280	320	360	400						
	In = 630 A	lo =	250	280	320	350	400	450	500	570	630						
		Keypad setting	Fine adjustment in 1 A steps below maximum value set on dial														
Time delay (s)	tr = ...	Keypad setting	0.5	1	2	4	8	16									
	accuracy 0 to -30 %	1.5 x Ir	12	25	50	100	200	400									
	accuracy 0 to -20 %	6 x Ir	0.5	1	2	4	8	16									
	accuracy 0 to -20 %	7.2 x Ir	0.35	0.7	1.4	2.8	5.5	11									
Thermal memory			20 minutes before and after tripping														

S Short-time protection with adjustable time delay

Pick-up (A) accuracy ±10 %	Isd = Ir x ...	Dial setting for MicroLogic 5	Value depending on trip unit rating (In) and setting on dial														
			1.5	2	3	4	5	6	7	8	10						
		Keypad settings for MicroLogic 6	Adjustment in steps of 0.5 x Ir over the range 1.5 x Ir to 10 x Ir														
Time delay (s)	tsd = ...	Keypad setting	0	0.1	0.2	0.3	0.4										
		I²Off	-	0.1	0.2	0.3	0.4										
		I²On	-	0.1	0.2	0.3	0.4										
	Non-tripping time (ms)		20	80	140	230	350										
	Maximum break time (ms)		80	140	200	320	500										

I Instantaneous protection

Pick-up (A) accuracy ±15 %	li = In x	Keypad setting	Adjustment in steps of 0.5 x In over the range 1.5 x In to: 15 x In (40 to 160 A), 12 x In (250 to 400 A) or 11 x In (630 A)														
	Non-tripping time		10 ms														
	Maximum break time		50 ms														

G Ground-fault protection - for MicroLogic 6 E

Pick-up (A) accuracy ±10 %	Ig = In x	Dial setting	Value depending on trip unit rating (In) and setting on dial														
	In = 40 A		0.4	0.4	0.5	0.6	0.7	0.8	0.9	1	Off						
	In > 40 A		0.2	0.3	0.4	0.5	0.6	0.7	0.8	1	Off						
			Fine adjustment in 0.05 x In steps using the keypad														
Time delay (s)	tg = ...	Keypad setting	0	0.1	0.2	0.3	0.4										
		I²Off	-	0.1	0.2	0.3	0.4										
		I²On	-	0.1	0.2	0.3	0.4										
	Non-tripping time (ms)		20	80	140	230	350										
	Maximum break time (ms)		80	140	200	320	500										
Test	Ig function		Built-in														

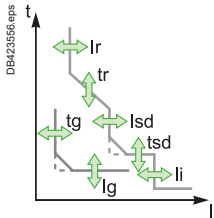

[1] If the trip units are used in high-temperature environments, the MicroLogic setting must take into account the thermal limitations of the circuit breaker. See the temperature derating table.

[2] For 40 A rating, the neutral N/2 adjustment is not possible.



Protection of Distribution Systems with Earth Leakage Protection

Selecting the Appropriate Residual Current Device

Residual current devices (RCDs) should be coordinated properly to achieve total selectivity, in addition to overcurrent protection. The selection of the appropriate type of RCD, in particular the type (AC, A, B, etc.) follows the same fire prevention as for protection against electric shock. See when to use each type of RCD.

The tables below are an illustration of breakers with appropriate RCD

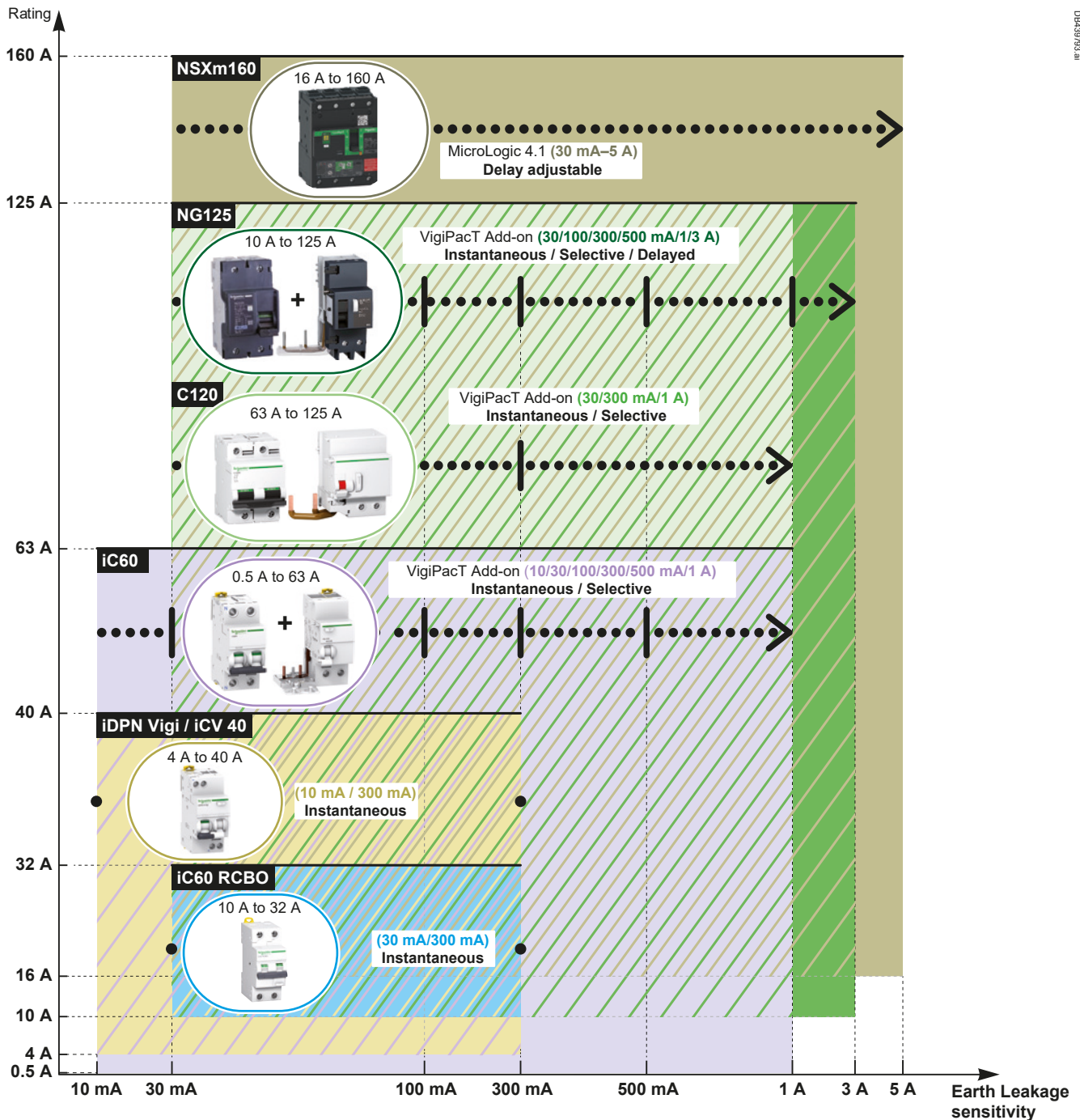

B

DB439783.ai

Protection of Distribution Systems with Earth Leakage Protection

Selecting the Appropriate Residual Current Device

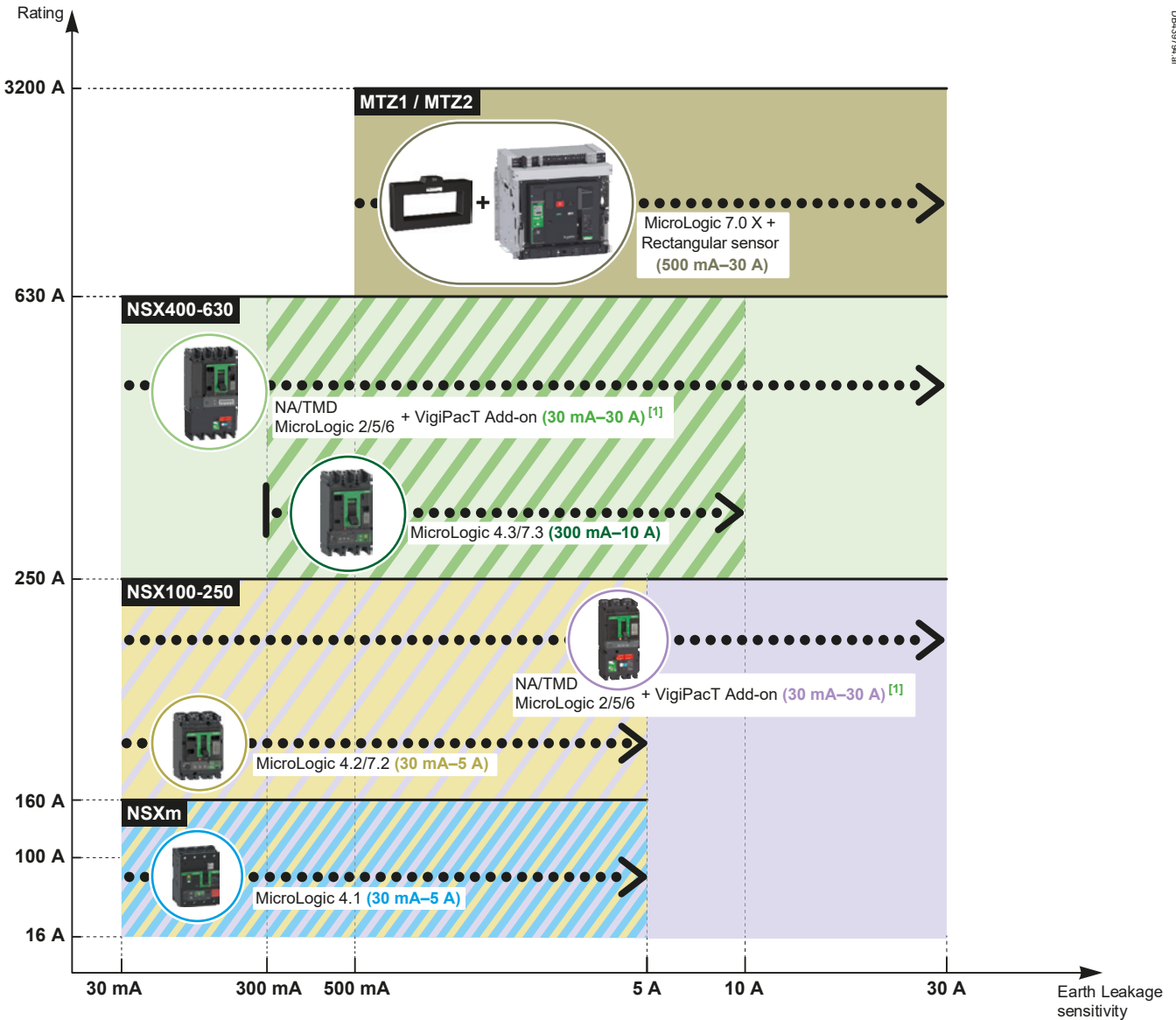

DB439794_01



For more details on the MicroLogic Vigi protections, see the [VigiPacT Catalog](#).



Protection of Distribution Systems with Earth Leakage Protection

Selecting the Appropriate Residual Current Device

Overview of circuit breakers with separate earth leakage relay type A/AC

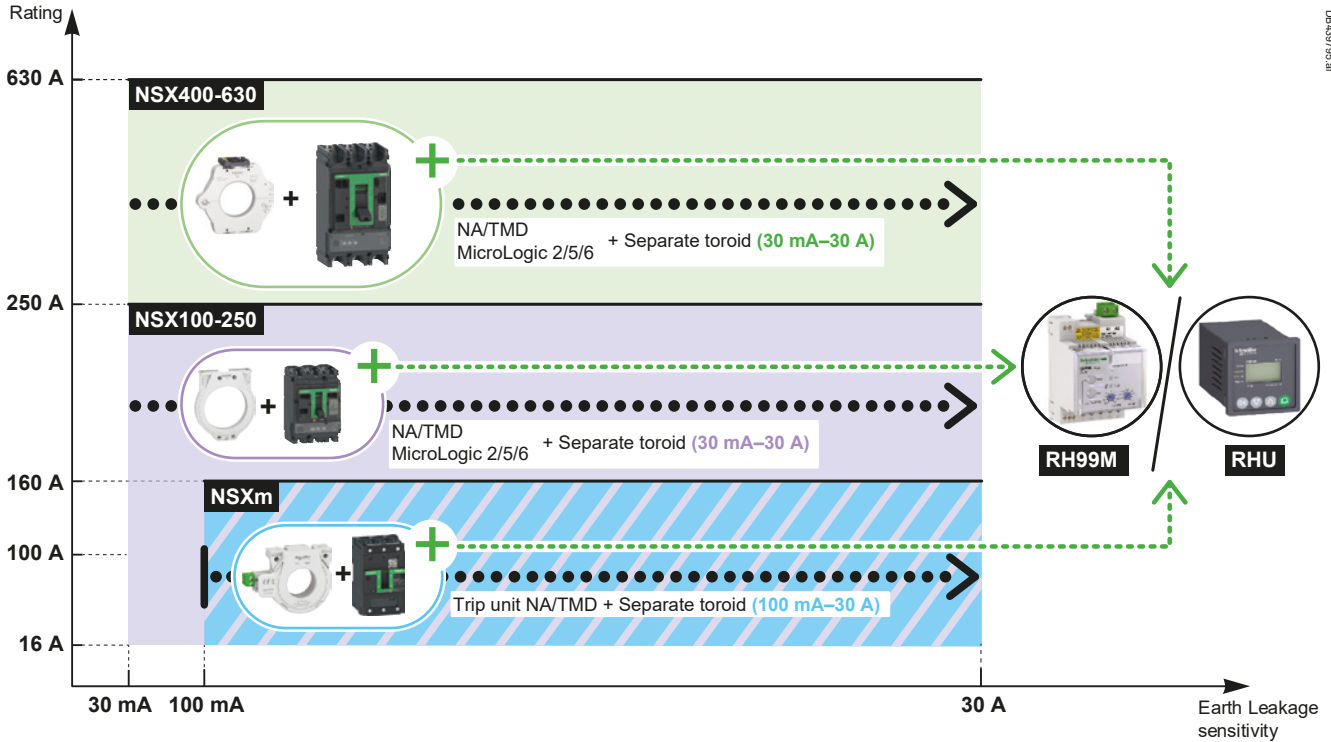

DB443796_01

B

Overview of circuit breakers with separate earth leakage relay type B

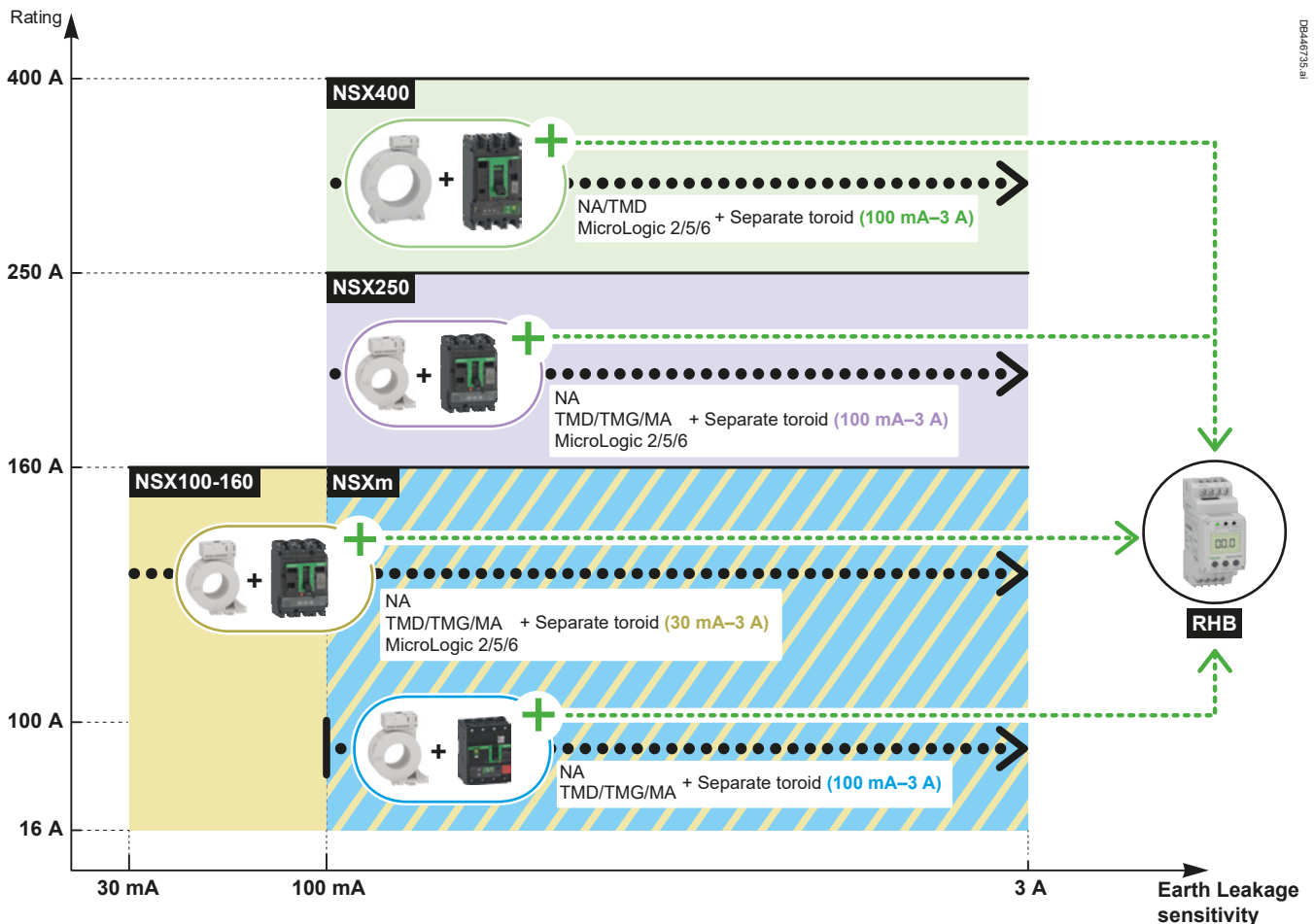

DB443796_01

Protection of Distribution Systems

ComPacT NSXm MicroLogic Vigi 4.1 Trip Unit with Integrated Earth Leakage Protection

ComPacT NSXm circuit breakers up to 160 A can be ordered with MicroLogic Vigi 4.1 trip unit with performance levels E/B/F/N/H.

They provide:

- Standard protection of distribution cables
- Earth leakage protection
- Indication of:
 - Overload alarming (via LEDs and via SDx module)
 - Overload tripping (via the SDx module)
 - Earth leakage alarming (via the SDx module)
 - Earth leakage tripping (via front face screen and the SDx module).

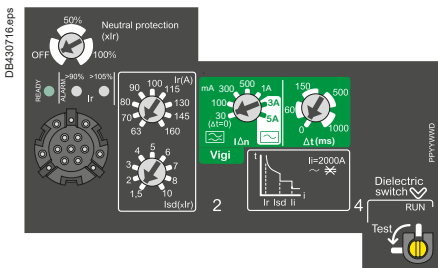

ComPacT NSXm MicroLogic Vigi 4.1

MicroLogic Vigi 4.1

Circuit breakers equipped with MicroLogic Vigi 4.1 trip units can be used for distribution systems supplied by transformers.

Short-Circuit and Overload Protection

Settings are made using the adjustment dials.

L Overloads: Long Time Protection (Ir)

Inverse time protection against overloads with a wide range adjustable current pick-up Ir set using a dial and a non-adjustable time delay tr.

S Short-Circuits: Short-Time Protection with Fixed Time Delay (Isd)

Protection with an adjustable pick-up Isd. Tripping takes place after a very short delay used to allow selectivity with the downstream device.

I Short-Circuits: Non-Adjustable Instantaneous Protection

Instantaneous short-circuit protection with a fixed pick-up.

Neutral Protection

- On 3-pole circuit breakers, neutral protection is not possible.
- On 4-pole circuit breakers, neutral protection may be set using a three-position switch:
 - OFF: neutral unprotected
 - 50% ^[1]: neutral protection at half the value of the phase pick-up, i.e. 0.5 x Ir
 - 100%: neutral fully protected at Ir

R Earth Leakage Protection

Protection with an adjustable leakage level (IΔn) with an adjustable delay (Δt).

Compliance with Standards

- IEC 60947-2, annex B.
- IEC 60755, class A, immunity to DC components up to 6 mA.
- Operation down to -25 °C as per VDE 664.

Power Supply

It is self-powered internally and therefore does not require any external source. It's still working even when supplied by only two phases.

Sensitivity IΔn (A)

- Type A: 30mA - 100mA - 300mA - 500mA - 1A.
- Type AC: 30mA - 100mA - 300mA - 1A - 3A - 5A.

Intentional Delay Δt (Ms)

0 - 60 ^[2] - 150 ^[2] - 500 ^[2] - 1000 ^[2].

Operated Voltage

200...440 V AC - 50/60 Hz.

Operating Safety

The earth leakage protection is a user safety device. It must be tested at regular intervals using the test button.

[1] On 100A and 160A circuit breakers only.
 [2] If the sensitivity is set to 30 mA, there is no time delay, whatever the time-delay setting.

Note: All the trip units have a transparent lead-sealable cover that avoids access to the adjustment dials.



Protection of Distribution Systems

ComPacT NSXm MicroLogic Vigi 4.1 Trip Unit with Integrated Earth Leakage Protection

Indications

Front Indications

- Green "Ready" LED: the MicroLogic current transformer is continuously monitored by automatic tests. The MicroLogic will trip if the current transformer malfunctions. The blinking green "Ready" LED indicates that protection links—from CTs to electronics to the minitop release—are fully operational with no test kit required. This feature works from 15 to 50 A, depending on the device. For lower loads, a pocket battery can be used to activate the indication.
- Orange overload pre-alarm LED: steady on when $I > 90\% I_r$.
- Red overload LED: steady on when $I > 105\% I_r$.
- Screen that indicate an earth leakage fault trip - reset when product is powered.

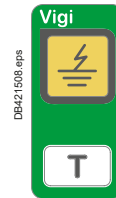
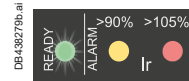

Alarming and Fault Differentiation

A side module SDx can be installed to provide alarming and fault differentiation:

- Overload alarm ($I > 105\% I_r$)
- Overload trip indication
- Earth leakage alarm ($I_{\Delta n} > 80\%$ threshold)
- Earth leakage trip indication.

This module receives the signal from the MicroLogic electronic trip unit via an optical link and makes it available on the terminal block through NO/NC dry contacts.

The signal is cleared when the circuit breaker is restarted.

For description, see page C-11.

B

MicroLogic Vigi 4.1

	Ratings (A)	I_n at 40 °C [1]	25	50	100	160					
	Circuit breaker	ComPacT NSXm	●	●	●	●					
L Long-time protection											
	Pick-up (A)	I_r	Value depending on trip unit rating (I_n) and setting on dial								
	tripping between 1.05 and 1.20 I_r	$I_n = 25\text{ A}$	$I_r = 10$	11	12	14	16	18	20	22	25
		$I_n = 50\text{ A}$	$I_r = 20$	22	25	28	32	36	40	45	50
		$I_n = 100\text{ A}$	$I_r = 40$	45	50	56	63	70	80	90	100
		$I_n = 160\text{ A}$	$I_r = 63$	70	80	90	100	115	130	145	160
	Time delay (s)	tr	Non-adjustable								
		accuracy 0 to -30%	1.5 x I_r	200							
		accuracy 0 to -20%	6 x I_r	8							
		accuracy 0 to -20%	7.2 x I_r	5							
	Thermal memory	20 minutes before and after tripping									
S₀ Short-time protection with fixed time delay											
	Pick-up (A) accuracy ±15 %	Isd = $I_r \times \dots$	1.5	2	3	4	5	6	7	8	10
	Time delay (ms)	tsd	Non-adjustable								
		Non-tripping time	20								
		Maximum break time	80								
I Instantaneous protection											
	Pick-up (A) accuracy ±15 %	I_i non-adjustable	375	750	1500	2000					
		Non-tripping time	10 ms			5 ms					
		Maximum break time	50 ms								
R Earth leakage protection											
	Sensitivity $I_{\Delta n}$ (A)	Adjustable	$I_{\Delta n} =$	0.03	0.1	0.3	0.5	1	3 5		
		Type	A and AC								
	Time delay Δt (ms)	Adjustable	$\Delta t =$	0	60 [2]	150 [2]	500 [2]	1000 [2]			
		Maximum break time (ms)	< 40	< 140	< 300	< 800	< 1500				

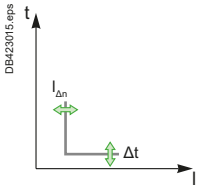
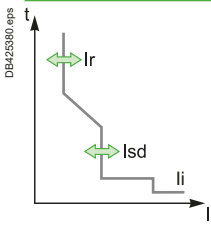

[1] If the circuit breakers are used in high-temperature environments, the setting must take into account the thermal limitations of the circuit breaker.
 [2] If the sensitivity is set to 30 mA, there is no time delay, whatever the time-delay setting.

Protection of Distribution Systems

ComPacT NSX MicroLogic Vigi 4 Trip Unit with Integrated Earth Leakage Protection

The ComPacT NSX range is now complemented with a new type of MicroLogic trip unit including both circuit protection and earth leakage protection. It means that the earth leakage protection, previously located within the VigiPacT add-on, will be integrated within the existing size of the MicroLogic trip unit. MicroLogic Vigi 4 is compliant with IEC 60947-2 annex B.

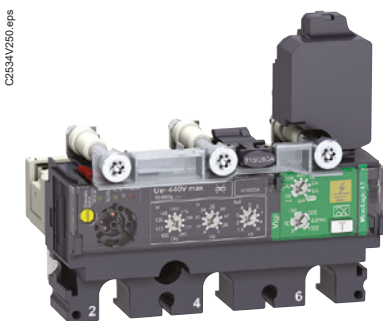

MicroLogic Vigi 4 (LS₀IR)

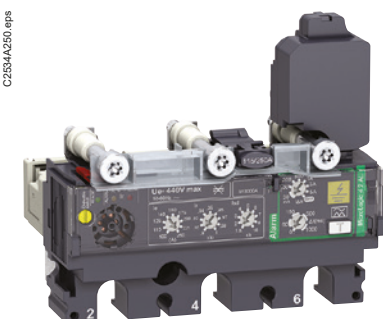

MicroLogic Vigi 4 AL (LS₀I + Earth Leakage Alarm)

MicroLogic Vigi 4

There are two versions of MicroLogic Vigi 4:

- Distribution protection including Earth Leakage Protection (LS₀IR)
- Distribution protection including Earth Leakage Alarm (LS₀I + Earth Leakage Alarm).

Protections

Settings are made using the rotary dial with fine adjustment capabilities.

Short Circuit and Overload Protections

L Overload: Long-Time Protection (Ir)

Inverse time protection against overload with an adjustable current pick-up Ir set using a dial and a non-adjustable time delay tr.

S Short-Circuit: Short-Time Protection with Fixed Time Delay (I_{sd})

That protection is set with an adjustable pick-up I_{sd}. The tripping takes place after a very short time used to allow selectivity with downstream devices.

I Short Circuit: Non-Adjustable Instantaneous Protection

Instantaneous Short-Circuit Protection with a Fixed Pick-up.

Neutral Protection

- On a 3-pole device, neutral protection is not possible
- On a 4-pole device, neutral protection may be set using the dedicated coding wheel to meet the following configurations: 4P 3D, 4P 3D + N/2 or 4P 4D (same as for MicroLogic 2).

R Earth Leakage Protections

Adjustable leakage threshold (I_{Δn}) and adjustable time delay threshold (Dt) by using the two dials on the green area of the trip unit.

Power Supply

The trip unit is self supplied, and so does not need any external source. It works even when fed by 2 phases only.

Sensitivity I_{Δn} (A)

- Type A: 30mA - 100mA - 300mA - 500mA - 1A - 3A - 5A (for the ratings 40 to 250A)
- Type A: 300mA - 500mA - 1A - 3A - 5A - 10A (for the ratings 400 to 570A).

Caution: "OFF" setting of I_{Δn} is possible. It cancels the earth leakage protection, in that case, the circuit breaker with MicroLogic Vigi 4 behaves as a standard circuit breaker. That "OFF" position is located on the highest side of the coding wheel.

Intentional Delay I_{Δt} (S)

Case I_{Δn} = 30mA: Δt 0 sec (whatever the setting)

Case I_{Δn} > 30mA: Δt 0 – 60ms – 150ms – 500ms – 1sec (by setting)

Operated Voltage

200 to 440 VAC (only) – 50/60 Hz

Operating Safety

The earth leakage protection is a user safety device. It must be regularly tested using the test button (T) that simulates a real current leakage within the toroid. When I_{Δn} is set on the OFF position, press the T will cancel any test.

As for standard circuit breaker, the circuit breaker with MicroLogic Vigi 4 can be reset after any fault by operating an OFF/ON procedure.

Specific for the circuit breaker with MicroLogic Vigi 4 Alarm (AL), after testing as well as after a real leakage fault, it can be reset by pressing more than 3 seconds the test button (T), to avoid switching OFF the device.

Protection of Distribution Systems

ComPacT NSX MicroLogic Vigi 4 Trip Unit with Integrated Earth Leakage Protection

Indications

Front Indications

- Green "Ready" LED: the MicroLogic current transformer is continuously monitored by automatic tests. The MicroLogic will trip if the current transformer malfunctions. The blinking green "Ready" LED indicates that protection links—from CTs to electronics to the minitop release—are fully operational with no test kit required. This feature works from 15 to 50 A, depending on the device. For lower loads, a pocket battery can be used to activate the indication.
- Orange overload pre-alarm LED: steady ON when $I > 90\%$ I_r .
- Red overload LED: steady ON when $I > 105\%$ I_r .
- Yellow Screen: indicates an earth leakage fault (reset when operating OFF/ON for the "trip" or when pressing $>3\text{sec}$ the T button for the Alarm).

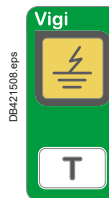
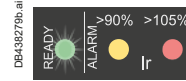

Alarming and Fault Differentiation

- An overload trip signal can be remotely available by installing an SDx relay module inside the circuit breaker on both "trip" and "alarm" versions.
- An earth leakage trip signal can be remotely available by installing an SDx module, only on the "trip" version.
- An earth leakage alarm signal (MicroLogic Vigi 4 AL) can be remotely available on the SDx, for the circuit breaker with MicroLogic Vigi 4 alarm".

This module receives the signal from the MicroLogic trip unit via an optical link and makes it available on the terminal block. The signal is reset when the breaker is operated.

MicroLogic Vigi 4

	Ratings (A)	In at 40 °C [1]	40	100	160	250	400	570		
	Circuit breaker	ComPacT NSX100	●	●						
		ComPacT NSX160	●	●	●					
		ComPacT NSX250	●	●	●	●				
		ComPacT NSX400					●			
		ComPacT NSX630						●	●	
L Long-time protection										
Pick-up (A) tripping between 1.05 and 1.20 I_r	I_n	I_o	Value depending on the rating (I_n) and the dial setting							
	$I_n = 40\text{ A}$	$I_o = 18$	18	20	23	25	28	32	36	40
	$I_n = 100\text{ A}$	$I_o = 40$	45	50	55	63	70	80	90	100
	$I_n = 160\text{ A}$	$I_o = 63$	70	80	90	100	110	125	150	160
	$I_n = 250\text{ A}$	$I_o = 100$	110	125	140	160	175	200	225	250
	$I_n = 400\text{ A}$	$I_o = 160$	180	200	230	250	280	320	360	400
	$I_n = 570\text{ A}$	$I_o = 250$	280	320	350	400	450	500	570	570
	$I_r = I_o \times x$		9 fine adjustment settings from 0.9 to 1 (0.9 – 0.92 ... 0.98 - 1)							
Time delay (s)	t_r	Non-adjustable								
	accuracy 0 to -30% at	1.5 x I_r	$t_r = 400\text{ s}$							
	accuracy 0 to -20% at	6 x I_r	$t_r = 16\text{ s}$							
	accuracy 0 to -20% at	7.2 x I_r	$t_r = 11\text{ s}$							
Thermal memory	20 minutes before and after tripping									
S₀ Short-time protection with fixed time delay										
Pick-up (A) accuracy $\pm 10\%$	$I_{sd} = I_r \times \dots$	1.5	2	3	4	5	6	7	8	10
Time delay (ms)	t_{sd}	Non-adjustable								
	Non-tripping time	20								
	Maximum break time	80								
I Instantaneous protection										
Pick-up (A) accuracy $\pm 15\%$	I_i	non-adjustable	600	1500	2400	3000	4800	6900		
	Non-tripping time	10 ms								
	Maximum break time	50 ms								
R Earth leakage protection/Earth leakage alarm										
Sensitivity (A)	Type A, adjustable (9 positions)									
	$I_n = 40\text{ A}$	$\Delta I_n = 0.03$	0.03	0.1	0.3	0.5	1	3	5	OFF
	$I_n = 100\text{ A}$	$\Delta I_n = 0.03$	0.03	0.1	0.3	0.5	1	3	5	OFF
	$I_n = 160\text{ A}$	$\Delta I_n = 0.03$	0.03	0.1	0.3	0.5	1	3	5	OFF
	$I_n = 250\text{ A}$	$\Delta I_n = 0.03$	0.03	0.1	0.3	0.5	1	3	5	OFF
	$I_n = 400\text{ A}$	$\Delta I_n = 0.3$	0.3	0.5	1	3	5	10	10	OFF
	$I_n = 570\text{ A}$	$\Delta I_n = 0.3$	0.3	0.5	1	3	5	10	10	OFF
Time delay Δt (ms)	Adjustable	$\Delta t = 0$	60 [2]	150 [2]	500 [2]	1000 [2]				
	Maximum break time (ms)	<40	<140	<300	<800	<1500	ms			

[1] For the use in high temperature environment, take into account the thermal limitation of the breaker.

[2] The time delay (Δt) is mandatory and forced to " $\Delta t = 0$ " when the ΔI_n dial is set on 30mA (0.03). The time delay has no effect when the dial ΔI_n is set to the "OFF" position.

Protection of Distribution Systems

ComPacT NSX MicroLogic Vigi 7 E Trip Unit with Integrated Earth Leakage Protection

The ComPacT NSX range is now complemented with a new type of MicroLogic trip unit including circuit protection, metering and earth leakage protection. It means that the earth leakage protection, previously located within the VigiPacT add-on, will be integrated within the existing size of the MicroLogic trip unit. MicroLogic Vigi 7 E is compliant with IEC 60947-2 annex B.

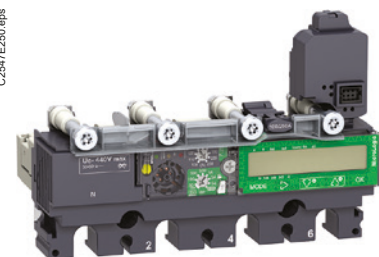

MicroLogic Vigi 7 E (LSIR)

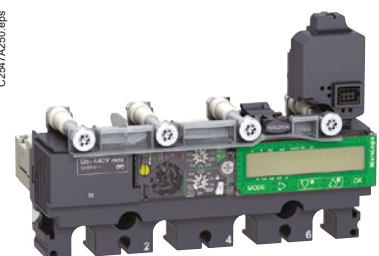

MicroLogic Vigi 7 E AL (LSI + Earth Leakage Alarm)

MicroLogic Vigi 7 E

There are two versions of MicroLogic Vigi 7 E:

- Distribution protection including Earth Leakage Protection (LSIR)
- Distribution protection including Earth Leakage Alarm (LSI + Earth Leakage Alarm).

Locking Protection - Parameter Settings

Settings are made using the rotary dial or/and the keypad. The protection parameter settings are locked when the transparent cover is closed and sealed to avoid access to the adjustment dials and the locking/unlocking microswitch. But you can display the various parameters using the keypad even when the cover is closed (and sealed).

Short Circuit and Overload Protections

L Overload: Long Time Protection (I_r)

Inverse time protection against overload with an adjustable current pick-up I_r set using the dial or the keypad for fine adjustments. The adjustable time delay t_r is set using the keypad only.

S Short-Circuit: Short Circuit Protection (I_{sd})

That protection is with an adjustable pick-up I_{sd} and an adjustable time delay t_{sd} . It is possible to include a portion of an inverse time curve (I^2t On).

I Short Circuit: Instantaneous Protection (I_i)

Instantaneous protection with an adjustable protection pick-up I_i .

Neutral Protection

- On a 4-pole device, the neutral protection may be set using the dedicated coding wheel to meet the following configurations: 4P 3D, 4P 3D + N/2 or 4P 4D (same as for MicroLogic 5).
- OSN (Oversized Neutral Protection) at 1.6 times the phase pick-up value; useful where there is a high level of 3rd order harmonics (or multiple of 3) that create an over-current within the neutral. In that case the device has to be limited to $I_r = I_n \times 0.63$ (for each phase) to allow the neutral protection setting to $1.6 \times I_r$.

R Earth Leakage Protections

Adjustable leakage threshold ($I_{\Delta n}$) using the dial only (without any use of the keypad for fine-tuning) and an adjustable time delay threshold (Δt) using the keypad only.

Power Supply

The MicroLogic trip unit is powered with its own current for continuous protection functions.

If there is no optional external 24 VDC power supply, the MicroLogic trip unit only works when the circuit breaker is closed. When the circuit breaker is open or the through current is low (15 to 50 A depending on the rating), the MicroLogic trip unit is no longer powered and its display switches off.

An external 24 VDC power supply for the MicroLogic trip unit is optional for:

- Modifying the setting values when the circuit breaker is open
- Displaying measurements when there is a low current through the circuit breaker (15 to 50 A depending on the rating) when the circuit breaker is closed
- Continuing to display the reason for the trip and the breaking current when the circuit breaker is open.

Sensitivity $I_{\Delta n}$ (A)

- Type A: 30mA - 100mA - 300mA - 500mA - 1A - 3A - 5A (for the ratings 40 to 250A)
- Type A: 300mA - 500mA - 1A - 3A - 5A - 10A (for the ratings 400 to 570A)

Caution: "OFF" setting of $I_{\Delta n}$ is possible, it cancels the earth leakage protection, in that case, the circuit breaker with MicroLogic Vigi 4 behaves as a standard circuit breaker. "OFF" position is located on the highest side of the coding wheel.

Select Protection

Protection of Distribution Systems

ComPacT NSX MicroLogic Vigi 7 E Trip Unit with Integrated Earth Leakage Protection

Intentional Delay $I\Delta t$ (S)

- Case $I\Delta n = 30\text{mA}$: Δt 0 sec
- Case $I\Delta n > 30\text{mA}$: Δt 0 – 60ms – 150ms – 500ms – 1sec

Operated Voltage

200 to 440 VAC (only) – 50/60 Hz

Operating Safety

The earth leakage protection is a user safety device. It must be regularly tested using the test button (T) that simulates a real current leakage within the toroid. When $I\Delta n$ is set on the OFF position, press the T will cancel any test. As for the standard circuit breaker, the circuit breaker with MicroLogic Vigi 7 E ("Trip" or "Alarm" version) can be reset after any fault by using the keypad.

The MicroLogic Vigi 7 E allows you to set-up a specific "(T) test without tripping" procedure using the keypad.

Display of the Type of Fault

On a trip, the root cause of the fault (phase and interrupted current) is displayed. An external power supply is needed for this function.

B

Protection of Distribution Systems

ComPacT NSX MicroLogic Vigi 7 E Trip Unit with Integrated Earth Leakage Protection

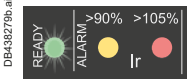

Indications

Front Indication

- Green "Ready" LED: the MicroLogic current transformer is continuously monitored by automatic tests. The MicroLogic will trip if the current transformer malfunctions. The blinking green "Ready" LED indicates that protection links—from CTs to electronics to the minitop release—are fully operational with no test kit required. This feature works from 15 to 50 A, depending on the device. For lower loads, a pocket battery can be used to activate the indication.
- Orange overload pre-alarm LED: steady ON when $I > 90\% I_r$.
- Red overload LED: steady ON when $I > 105\% I_r$.

Written on keypad: earth leakage fault indication (reset using the keypad) for both "Trip" and "Alarm".

Alarming and Fault Differentiation

An SDx relay module can be installed inside the earth leakage circuit breaker to remotely access to the following data:

- Overload pre-Alarm
- Overload trip
- Earth leakage pre-alarm (useful for the "trip" version of the circuit breaker with MicroLogic Vigi 7 E only)
- Earth leakage trip (exist for the "trip" version of the circuit breaker with MicroLogic Vigi 7 E only)
- Earth leakage Alarm without "trip" (circuit breaker with MicroLogic Vigi 7 E AL version only).

This module receives the signal from the MicroLogic electronic trip unit via an optical link and makes it available on the terminal block. The signal is reset when the breaker is operated.

These outputs can be reprogrammed to be assigned to other types of tripping or alarm. The module is deeper described in the section dealing with accessories.

Protection of Distribution Systems

ComPacT NSX MicroLogic Vigi 7 E Trip Unit with Integrated Earth Leakage Protection

MicroLogic Vigi 7 E

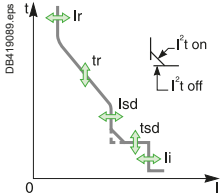

Ratings (A)	In at 40 °C [1]	40 [2]	100	160	250	400	570
Circuit breaker	ComPacT NSX100	●	●				
	ComPacT NSX160	●	●	●			
	ComPacT NSX250	●	●	●	●		
	ComPacT NSX400					●	
	ComPacT NSX630					●	●

L Long-time protection

Pick-up (A)	Dial setting	Value depending on the rating (In) and the dial setting									
tripping between 1.05 and 1.20 Ir	Ir										
	In = 40 A	Io =	18	18	20	23	25	28	32	36	40
	In = 100 A	Io =	40	45	50	55	63	70	80	90	100
	In = 160 A	Io =	63	70	80	90	100	110	125	150	160
	In = 250 A	Io =	100	110	125	140	160	175	200	225	250
	In = 400 A	Io =	160	180	200	230	250	280	320	360	400
In = 570 A	Io =	250	280	320	350	400	450	500	570	570	
Time delay (s)	Keypad setting	Fine adjustment in 1A step below the max value set on the dial									
	tr										
	Keypad setting	0.5	1	2	4	8	16				
	accuracy 0 to -30% at	1.5 x Ir	12	25	50	100	200	400			
	accuracy 0 to -20% at	6 x Ir	0.5	1	2	4	8	16			
	accuracy 0 to -20% at	7.2 x Ir	0.35	0.7	1.4	2.8	5.5	11			
Thermal memory		20 minutes before and after tripping									

S Short-time protection with adjustable time delay

Pick-up (A)	Isd = Ir x ... keypad settings	Adjustment in steps of 0.5 x Ir over the range 1.5 x Ir to 10 x Ir								
accuracy ±10 %										
Time delay (ms)	tsd	I ² Of	0	0.1	0.2	0.3	0.4			
	Keypad	I ² On	-	0.1	0.2	0.3	0.4			
	Non-tripping time (ms)		20	80	140	230	350			
	Maximum break time		80	140	200	320	500			

I Instantaneous protection

Pick-up (A)	Ii = In x	Adjustment in steps of 0.5 x In over the range 1.5 x In to:								
accuracy ±15 %	Keypad settings	15 x In (40 to 160A), 12 x In (250 to 400A), or 12 x In (570A)								
	Non-tripping time	10 ms								
	Maximum break time	50 ms								

R Earth leakage protection/Earth leakage alarm

Sensitivity (A)	Type A, adjustable (9 positions)										
	In = 40 A	IΔn =	0.03	0.03	0.1	0.3	0.5	1	3	5	OFF
	In = 100 A	IΔn =	0.03	0.03	0.1	0.3	0.5	1	3	5	OFF
	In = 160 A	IΔn =	0.03	0.03	0.1	0.3	0.5	1	3	5	OFF
	In = 250 A	IΔn =	0.03	0.03	0.1	0.3	0.5	1	3	5	OFF
	In = 400 A	IΔn =	0.3	0.3	0.5	1	3	5	10	10	OFF
In = 570 A	IΔn =	0.3	0.3	0.5	1	3	5	10	10	OFF	
Time delay Δt (ms)	Adjustable keypad Δt =	0	60 [3]	150 [3]	500 [3]	1000 [3]					
	Maximum break time (ms)	<40	<140	<300	<800	<1500					

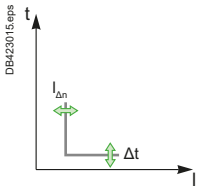

[1] For the use in high temperature environment, take into account the thermal limitation of the breaker.
 [2] For the rating 40A, the N/2 adjustment is not possible
 [3] The time delay (Δt) is mandatory and designed "Δt = 0" when the IΔn dial is set on 30mA (0.03). The time delay has no effect when the dial IΔn is set to the "OFF" position.

Protection of Distribution Systems

ComPacT NSX VigiPacT Add-on Protection Against Insulation Faults

There are three ways to add earth-leakage protection and alarm to any three pole or four pole ComPacT NSX circuit breaker equipped with magnetic, thermal-magnetic or Micrologic 2, 5, 6 trip units:

- Upgrade the existing trip unit without changing the basic frame to embedded earth-leakage protection by using Micrologic 4 or 7 trip units.
- Add a VigiPacT add-on to the circuit breaker.
- Use an external VigiPacT relay and separate toroids.



ComPacT NSX and MicroLogic 4 and 7



ComPacT NSX and VigiPacT add-on

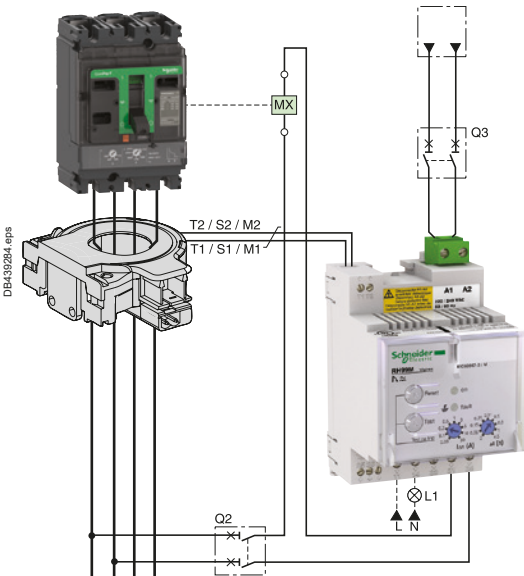

ComPacT NSX with VigiPacT external relay and toroid

Circuit Breaker with Embedded Earth-Leakage Protection Micrologic 4&7

Earth leakage protection integrated within the existing size of the MicroLogic trip unit and compliant with IEC 60947-2 annex B.

Circuit Breaker with VigiPacT Add-on

- For general characteristics of circuit breakers, see pages A-6 and A-7
- VigiPacT add-on
Earth-leakage protection is achieved by installing a VigiPacT add-on (characteristics and selection criteria on next page) directly on the circuit breaker terminals. It directly actuates the trip unit (magnetic, thermal-magnetic or MicroLogic).

ComPacT NSX Circuit Breaker with a VigiPacT Relay

VigiPacT relays may be used to add external earth-leakage protection to ComPacT NSX circuit breakers.

The circuit breakers must be equipped with an MN or MX voltage release.

The VigiPacT relays add special tripping thresholds and time delays for earth-leakage protection.

VigiPacT relays are very useful when faced with major installation constraints (circuit breaker already installed and connected, limited space available, etc.).

VigiPacT relay characteristics

- Sensitivity adjustable from 30 mA to 30 A and time-delay settings (0 to 4.5 seconds)
- Closed toroids up to 630 A (30 to 300 mm in diameter), opened toroids up to 250 A (80 to 120 mm in diameter) or rectangular sensors up to 630 A
- 50/60 Hz distribution systems

Relay types

- Type A: up to 5A (RH10, RH21, RH68, RH86, RH99, RH197, RHUs or RHU, RMH) and RHB
- Type AC: RH10, RH21, RH68, RH86, RH99, RH197, RHUs or RHU, RMH
- Type B: RHB

Options

- Trip indication by a fail-safe contact
- Pre-alarm contact and LED, etc.

Compliance with standards

- IEC 60947-2, annex M
- IEC/EN 60755: general requirements for residual-current operated protective devices
- IEC/EN 61000-4-2: Electrostatic-discharge immunity tests
- IEC/EN 61000-4-3: Radiated, radio-frequency, electromagnetic-field immunity tests
- IEC/EN 61000-4-4: Electrical fast transient/burst immunity tests
- IEC/EN 61000-4-5: Surge immunity tests
- IEC/EN 61000-4-6: Immunity tests for conducted disturbances induced by radio-frequency fields
- CISPR 11: Industrial, scientific and medical equipment - Radio-frequency disturbance characteristics - Limits and methods of measurement
- UL1053 and CSA C22.2 No. 144 for RH10, RH21 and RH99 relays at supply voltages up to and including 220/240 V.

Protection type

VigiPacT devices operate on TT, TNS and IT (for protection of persons against direct contact) systems.

The relays are type A, AC and B as defined by standard IEC/EN 60947-2.



Protection of Distribution Systems

ComPacT NSX VigiPacT Add-on

Protection Against Insulation Faults

ComPacT NSX VigiPacT Add-on

Addition of the VigiPacT add-on does not modify circuit-breaker characteristics:

- Compliance with standards
- Degree of protection, class II front-face insulation
- Positive contact indication
- Electrical characteristics
- Trip unit characteristics
- Installation and connection modes
- Indication, measurement and control auxiliaries
- Installation and connection accessories.

Dimensions and weights		NSX100/160/250	NSX400/630
Dimensions	3 poles	105 x 236 x 86	140 x 355 x 110
W x H x D (mm)	4 poles	140 x 236 x 86	185 x 355 x 110
Weight (kg)	3 poles	2.5	8.8
	4 poles	3.2	10.8

Compliance with standards

- IEC 60947-2, annex B
- IEC 60755, Type A, immunity to DC components up to 6 mA
- Operation down to -25 °C as per VDE 664

Remote indications

VigiPacT add-on may be equipped with an auxiliary contact (SDV) to remotely signal tripping due to an earth fault.

Use of 4-pole VigiPacT add-on with a 3-pole ComPacT NSX

In a 3-phase installation with an uninterrupted neutral, an accessory makes it possible to use a 4-pole VigiPacT add-on with connection of the neutral cable.

Power supply

VigiPacT add-on are self-powered internally by the distribution-system voltage and therefore do not require any external source. They continue to function even when supplied by only two phases.

ComPacT NSX VigiPacT Add-on

Type	Protection							
Number of poles	3, 4							
Ratings (A)	100, 160, 250, 400, 630							
I Δ n (A) Class A	0.03	0.1	0.3	0.5	1	3		
	[1]	0.03	0.06	0.25	0.375	0.5	3	
I Δ n (A) Class AC	10, 30							
Time delay (ms)	0	60	150	300	500	800	1200	4000
Max break time (ms)	<40 ^[2]	<150 ^[2]	<300	<500	<800	<1200	<2000	<5000
Rated voltages	200 - 440							
V AC 50/60Hz	440 - 550							

ComPacT NSX VigiPacT Add-on

Type	Alarm							
Number of poles	3, 4							
Ratings (A)	100, 160, 250, 400, 630							
I Δ n (A) Class A	0.03	0.1	0.3	0.5	1	3		
	-							
I Δ n (A) Class AC	10, 30							
Time delay (ms)	no settings 0 ms							
Max break time (ms)	-							
Rated voltages	200 - 440							
V AC 50/60Hz								

[1] Special settings for South Africa.

[2] Max break time according to IEC 60947-2 Annex B Clause B.4.2.4.

Longer time (<+20ms) may be experienced in case of closing on residual current (Clause B.8.2.4.5).



PB124109.eps

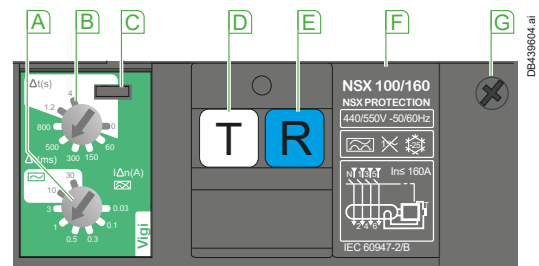

DB439604.ai

- A** Sensitivity setting
- B** Time-delay setting (for selective earth-leakage protection)
- C** Lead-seal fixture for controlled access to settings
- D** Test button simulating an earth-fault for regular checks on the tripping function
- E** Reset button (reset required after earth-fault tripping)
- F** Rating plate
- G** Housing for SDV auxiliary contact

Plug-in devices

The VigiPacT add-on can be installed on a plug-in base. Special accessories are required (see Catalog Numbers chapter).

Protection of Distribution Systems

ComPacT NSX and NSXm

Protection Against Insulation Faults Using a VigiPacT Relay

Detection with Associated Toroid



Alarm with the VigiPacT Relay



Protection with the Circuit Breaker



Function

VigiPacT relays measure the earth-leakage current in an electrical installation via their associated toroids.

VigiPacT relays may be used for:

- Residual-current protection (RH10, RH21, RH68, RH86, RH99, and RHB)
- Earth-leakage monitoring (RMH or RH99, and RHB)
- Residual-current protection and earth-leakage monitoring (RH197, RHUs, RHU, and RHB).

Residual-Current Protection Relay

Protection relays control the interruption of the supply of power to the monitored systems to help protect:

- People against indirect contact and, in addition, against direct contact
- Property against fire hazards
- Motors.

A relay trips the associated circuit breaker when the set residual operating current $I_{\Delta n}$ is overrun.

Depending on the relay, the threshold $I_{\Delta n}$ can be fixed, user-selectable or adjustable and the overrun can be signalled by a digital display of the measured current or a LED.

The leakage current is displayed:

- For the RH197, on a bargraph made up of 4 LEDs indicating levels corresponding to 20, 30, 40 and 50 % of $I_{\Delta n}$
- For the RHUs and RHU, by digital display of the value of the leakage current.

Circuit breaker tripping can be either instantaneous or delayed. On some relays, it is possible to adjust the time delay.

The protection relays store the residual-current fault in memory. Once the fault has been cleared and the output contact has been manually reset, the relay can be used again.

Earth-Leakage Monitoring Relays

These relays may be used to monitor drops in electrical insulation due to ageing of cables or extensions in the installation.

Continuous measurement of leakage currents makes it possible to plan preventive maintenance on the faulty circuits. An increase in the leakage currents may lead to a complete shutdown of the installation.

The control signal is issued by the relay when the residual-current operating threshold is overrun.

Depending on the relay, the threshold can be adjustable or user-selectable and the overrun can be signalled via a LED, a bargraph or a digital display of the measured current.

The leakage current is displayed:

- For the RH197, on a bargraph made up of 4 LEDs indicating levels corresponding to 20, 30, 40 and 50 % of $I_{\Delta n}$
- For the RMH, by digital display of the value of the leakage current.

The control signal can be either instantaneous or delayed. On some relays, it is possible to adjust the time delay.

Earth-leakage monitoring relays do not store the residual-current fault in memory and their output contact is automatically reset when the fault is cleared.

Use

VigiPacT relays may be used for protection and maintenance at all levels in the installation. Depending on the relays, they may be used in TT, IT or TNS low-voltage AC installations for voltages up to 1000 V and frequencies 50/60 Hz. VigiPacT protection relays are suitable for use with all electrical switchgear devices available on the market.



Protection of Distribution Systems

ComPacT NSX and NSXm

Protection Against Insulation Faults Using a VigiPacT Relay

Developed to be suitable for all installation systems, the VigiPacT range provides real simplicity of choice and assembly.

Overview of the VigiPacT Range

Protection and monitoring relays

Device						
		RH10M&P	RH21M&P	RH68M&P	RH86M&P	RHUs/RHU
Functions						
Protection		<input checked="" type="checkbox"/>	<input checked="" type="checkbox"/>	<input checked="" type="checkbox"/>	<input checked="" type="checkbox"/>	<input checked="" type="checkbox"/>
Monitoring		-	-	-	-	<input checked="" type="checkbox"/>
Local indications		<input checked="" type="checkbox"/>	<input checked="" type="checkbox"/>	<input checked="" type="checkbox"/>	<input checked="" type="checkbox"/>	<input checked="" type="checkbox"/>
Type	A	up to 5 A	up to 5 A	up to 5 A	up to 5 A	up to 5 A
	AC	<input checked="" type="checkbox"/>	<input checked="" type="checkbox"/>	<input checked="" type="checkbox"/>	<input checked="" type="checkbox"/>	<input checked="" type="checkbox"/>
Remote indications	Hard-wired	<input checked="" type="checkbox"/>	<input checked="" type="checkbox"/>	<input checked="" type="checkbox"/>	<input checked="" type="checkbox"/>	<input checked="" type="checkbox"/>
	Via com Modbus SL	-	-	-	-	<input checked="" type="checkbox"/> Except RHUs
Display of measurement		<input checked="" type="checkbox"/>	<input checked="" type="checkbox"/>	<input checked="" type="checkbox"/>	<input checked="" type="checkbox"/>	<input checked="" type="checkbox"/>

Protection and monitoring relays

Centralized monitoring relay

Device						
		RH99M&P	RH197M&P	RHB	RMH	RM12T
Functions						
Protection		-	<input checked="" type="checkbox"/>	<input checked="" type="checkbox"/>	-	-
Monitoring		<input checked="" type="checkbox"/>	<input checked="" type="checkbox"/>	-	<input checked="" type="checkbox"/>	<input checked="" type="checkbox"/>
Local indications		<input checked="" type="checkbox"/>	<input checked="" type="checkbox"/>	<input checked="" type="checkbox"/>	<input checked="" type="checkbox"/>	<input checked="" type="checkbox"/>
Type	A	up to 5 A	up to 5 A	up to 5 A	up to 5 A	up to 5 A
	AC	<input checked="" type="checkbox"/>	<input checked="" type="checkbox"/>	<input checked="" type="checkbox"/>	<input checked="" type="checkbox"/>	<input checked="" type="checkbox"/>
	B	-	-	<input checked="" type="checkbox"/>	-	-
Remote indications	Hard-wired	<input checked="" type="checkbox"/>	<input checked="" type="checkbox"/>	-	<input checked="" type="checkbox"/>	<input checked="" type="checkbox"/>
	Via communication	-	-	-	<input checked="" type="checkbox"/>	<input checked="" type="checkbox"/>
Display of measurement		<input checked="" type="checkbox"/>	<input checked="" type="checkbox"/>	<input checked="" type="checkbox"/>	<input checked="" type="checkbox"/>	<input checked="" type="checkbox"/> 12 measurement channels

Formats for All Installation Systems

Schneider Electric MCB format devices in the VigiPacT range can be mounted on a DIN rail (RH10, RH21, RH99 and RH197) or on a universal mounting plate using mounting lugs (RH10, RH21 and RH99). The 72 x 72 mm front-panel mount devices (RH10, RH21, RH99, RH197, RMH, RHUs and RHU) are mounted on panels, doors or front plates using clips.

Installation system	Suitable format	
	Front-panel mount	DIN rail
Main LV switchboard	<input checked="" type="checkbox"/>	
Power distribution switchboard	Instrument zone	<input checked="" type="checkbox"/>
	Modular-device zone	<input checked="" type="checkbox"/>
Motor Control Centre (MCC)		<input checked="" type="checkbox"/> With clip-in toroid
Automatic control panel or machine panel		<input checked="" type="checkbox"/> With mounting lugs
Final distribution enclosures		<input checked="" type="checkbox"/>

ComPacT NSX Motor Protection

General Information on Motor Feeders

The parameters to be considered for motor-feeder protection depend on:

- The application (type of machine driven, operating safety, frequency of operation, etc.)
- The level of continuity of service required by the load or the application
- The applicable standards for the protection of life and property.

The required electrical functions are:

- Isolation
- Switching, generally at high endurance levels
- Protection against overloads and short-circuits, adapted to the motor
- Additional special protection

A motor feeder must comply with the requirements of standard IEC 60947-4-1 concerning contactors and their protection:

- Coordination of feeder components
- Thermal-relay trip classes
- Contactor utilization categories
- Coordination of insulation

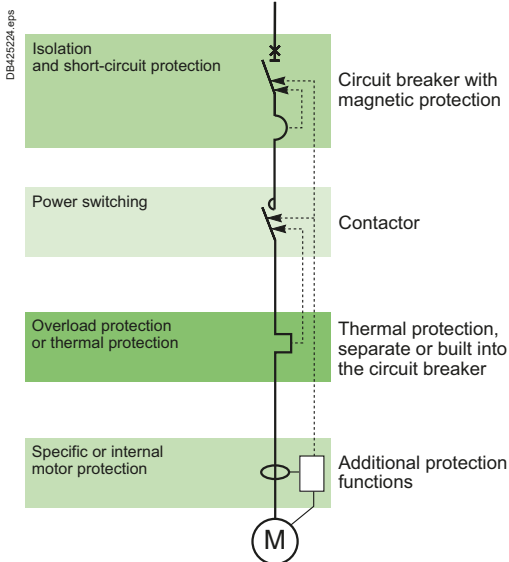
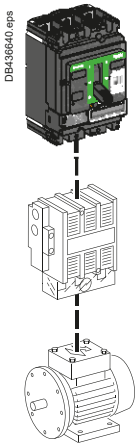

Switchgear functions in a motor feeder

Motor-Feeder Function

A motor feeder comprises a set of devices for motor protection and control, as well as for protection of the feeder itself.

Isolation

The purpose is to isolate the live conductors from the upstream distribution system to enable work by maintenance personnel on the motor feeder at no risk. This function is provided by a motor circuit breaker offering positive contact indication and lockout/tagout possibilities.

Switching

The purpose is to control the motor (ON/OFF), either manually, automatically or remotely, taking into account overloads upon start-up and the long service life required. This function is provided by a contactor. When the coil of the contactor's electromagnet is energized, the contactor closes and establishes, through the poles, the circuit between the upstream supply and the motor, via the circuit breaker.

Basic Protection

- **Short-circuit protection**
Detection and breaking, as quickly as possible, of high short-circuit currents to avoid damage to the installation. This function is provided by a magnetic or thermal-magnetic circuit breaker.
- **Overload protection**
Detection of overload currents and motor shutdown before temperature rise in the motor and conductors damages insulation. This function is provided by a thermal-magnetic circuit breaker or a separate thermal relay.

Overloads: $I < 10 \times I_n$

They are caused by:

- An electrical problem, related to an anomaly in the distribution system (e.g. phase failure, voltage outside tolerances, etc.)
- A mechanical problem, related to a process malfunction (e.g. excessive torque) or damage to the motor (e.g. bearing vibrations).

These two causes will also result in excessively long starting times.

Impedant short-circuits: $10 \times I_n < I < 50 \times I_n$

This type of short-circuit is generally due to deteriorated insulation of motor windings or damaged supply cables.

Short-circuits: $I > 50 \times I_n$

This relatively rare type of fault may be caused by a connection error during maintenance.

- **Phase unbalance or phase loss protection**
Phase unbalance or phase loss can cause temperature rise and braking torques that can lead to premature ageing of the motor. These effects are even greater during starting, therefore protection must be virtually immediate.

Additional Electronic Protection

- Locked rotor
- Under-load
- Long starts and stalled rotor
- Insulation faults

Motor-Feeder Solutions

IEC 60947 defines three types of device combinations for the protection of motor feeders.

Three devices

- Magnetic circuit breaker + contactor + thermal relay

Two devices

- Thermal-magnetic circuit breaker + contactor

One device

- Thermal-magnetic circuit breaker + contactor in an integrated solution (e.g. TeSys U)

B

ComPacT NSX Motor Protection

General Information on Motor Feeders

Device Coordination

The various components of a motor feeder must be coordinated. Standard IEC 60947-4-1 defines three types of coordination depending on the operating condition of the devices following a standardized short-circuit test.

Type 1 coordination

- No danger to life or property
- The contactor and/or the thermal relay may be damaged
- Repair and replacement of parts may be required prior to further service

Type 2 coordination

- No danger to life or property
- No damage or adjustments are allowed. The risk of contact welding is accepted as long as they can be easily separated
- Isolation must be maintained after the incident, the motor feeder must be suitable for further use without repair or replacement of parts
- A rapid inspection is sufficient before return to service

Total coordination

No damage and no risk of contact welding is allowed for the devices making up the motor feeder. The motor feeder must be suitable for further use without repair or replacement of parts.

This level is provided by integrated 1-device solutions such as TeSys U.

Contactor Utilization Categories

For a given motor-feeder solution, the utilization category determines the contactor withstand capacity in terms of frequency of operation and endurance. Selection, which depends on the operating conditions imposed by the application, may result in oversizing the contactor and circuit-breaker protection. IEC 60947 defines the following contactor utilization categories.

Contactor utilization categories (AC current)

Contactor utilization categories	Type of load	Control function	Typical applications
AC-1	Non-inductive ($\cos \varphi \geq 0.8$)	Energizing	Heating, distribution
AC-2	Slip-ring motor ($\cos \varphi \geq 0.65$)	Starting Switching off motor during running Counter-current braking Inching	Wiring-drawing machine
AC-3	Squirrel-cage motor ($\cos \varphi = 0.45$ for ≤ 100 A) ($\cos \varphi = 0.35$ for > 100 A)	Starting Switching off motor during running	Compressors, elevators, pumps, mixers, escalators, fans, conveyer systems, air-conditioning
AC-4		Starting Switching off motor during running Regenerative braking Plugging Inching	Printing machines, wire-drawing machines

Utilization category AC-3 - common coordination tables for circuit breakers and contactors

This category covers asynchronous squirrel-cage motors that are switched off during running, which is the most common situation (85 % of cases). The contactor makes the starting current and switches off the rated current at a voltage approximately one sixth of the nominal value. The current is interrupted without difficulty.

The circuit breaker-contactor coordination tables for ComPacT NSX are for use with contactors in the AC-3 utilization category, in which case they ensure type 2 coordination.

Utilization category AC-4 - possible oversizing

This category covers asynchronous squirrel-cage motors capable of operating under regenerative braking or inching (jogging) conditions

The contactor makes the starting current and can interrupt this current at a voltage that may be equal to that of the distribution system.

These difficult conditions make it necessary to oversize the contactor and, in general, the protective circuit breaker with respect to category AC-3.

B

ComPacT NSX Motor Protection

Motor-Feeder Characteristics and Solutions

The trip class determines the trip curve of the thermal protection device (inverse-time curve) for a motor feeder. Standard IEC 60947-4-1 defines trip classes 5, 10, 20 and 30. These classes are the maximum durations, in seconds, for motor starting with a starting current of 7.2 I_r, where I_r is the thermal setting indicated on the motor rating plate.

Example: In class 20, the motor must have finished starting within 20 seconds (6 to 20 s) for a starting current of 7.2 I_r.

Standardized values in kW

Rated operational power kW	Standardized values in kW currents I _e (A) for:			
	230 V A	400 V A	500 V A	690 V A
0.06	0.35	0.32	0.16	0.12
0.09	0.52	0.3	0.24	0.17
0.12	0.7	0.44	0.32	0.23
0.18	1	0.6	0.48	0.35
0.25	1.5	0.85	0.68	0.49
0.37	1.9	1.1	0.88	0.64
0.55	2.6	1.5	1.2	0.87
0.75	3.3	1.9	1.5	1.1
1.1	4.7	2.7	2.2	1.6
1.5	6.3	3.6	2.9	2.1
2.2	8.5	4.9	3.9	2.8
3	11.3	6.5	5.2	3.8
4	15	8.5	6.8	4.9
5.5	20	11.5	9.2	6.7
7.5	27	15.5	12.4	8.9
11	38	22	17.6	12.8
15	51	29	23	17
18.5	61	35	28	21
22	72	41	33	24
30	96	55	44	32
37	115	66	53	39
45	140	80	64	47
55	169	97	78	57
75	230	132	106	77
90	278	160	128	93
110	340	195	156	113
132	400	230	184	134
160	487	280	224	162
200	609	350	280	203
250	748	430	344	250
315	940	540	432	313

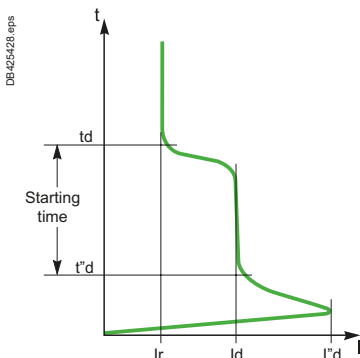

Typical motor-starting curve

Trip Class of a Thermal-Protection Device

The motor feeder includes thermal protection that may be built into the circuit breaker. The protection must have a trip class suited to motor starting. Depending on the application, the motor starting time varies from a few seconds (no-load start) to a few dozen seconds (high-inertia load). Standard IEC 60947-4-1 defines the trip classes below as a function of current setting I_r for thermal protection.

Trip class of thermal relays as a function of their I_r setting

Class	1.05 I _r [1]	1.2 I _r [1]	1.5 I _r [2]	7.2 I _r [1]
5	t > 2 h	t < 2h	t < 2 mn	0.5 s < t ≤ 5 s
10	t > 2 h	t < 2h	t < 4 mn	4 s < t ≤ 10 s
20	t > 2 h	t < 2h	t < 8 mn	6 s < t ≤ 20 s
30	t > 2 h	t < 2h	t < 12 mn	9 s < t ≤ 30 s

[1] Time for a cold motor (motor off and cold).

[2] Time for warm motor (motor running under normal conditions).

Currents of Squirrel-Cage Motors at Full Rated Load

Standardized values in HP

Rated operational power hp	Indicative values of the rated operational currents I _e (A) for						
	110 - 120 V	200 V	208 V	220 - 240 V	380 - 415 V	440 - 480 V	550 - 600 V
1/2	4.4	2.5	2.4	2.2	1.3	1.1	0.9
3/4	6.4	3.7	3.5	3.2	1.8	1.6	1.3
1	8.4	4.8	4.6	4.2	2.3	2.1	1.7
1 1/2	12	6.9	6.6	6	3.3	3	2.4
2	13.6	7.8	7.5	6.8	4.3	3.4	2.7
3	19.2	11	10.6	9.6	6.1	4.8	3.9
5	30.4	17.5	16.7	15.2	9.7	7.6	6.1
7 1/2	44	25.3	24.2	22	14	11	9
10	56	32.2	30.8	28	18	14	11
15	84	48.3	46.2	42	27	21	17
20	108	62.1	59.4	54	34	27	22
25	136	78.2	74.8	68	44	34	27
30	160	92	88	80	51	40	32
40	208	120	114	104	66	52	41
50	260	150	143	130	83	65	52
60	-	177	169	154	103	77	62
75	-	221	211	192	128	96	77
100	-	285	273	248	165	124	99
125	-	359	343	312	208	156	125
150	-	414	396	360	240	180	144
200	-	552	528	480	320	240	192
250	-	-	-	604	403	302	242
300	-	-	-	722	482	361	289

Note: 1 hp = 0.7457 kW.

Asynchronous-Motor Starting Parameters

The main parameters of direct on-line starting of three-phase asynchronous motors (90 % of all applications) are listed below.

- **I_r**: rated current
This is the current drawn by the motor at full rated load (e.g. approximately 100 A rms for 55 kW at 400 V).
- **I_d**: starting current
This is the current drawn by the motor during starting, on average 7.2 In for a duration t_d of 5 to 30 seconds depending on the application (e.g. 720 A rms for 10 seconds). These values determine the trip class and any additional "long-start" protection devices that may be needed.
- **I'_d**: peak starting current
This is the subtransient current during the first two half-waves when the system is energized, on the average 14 In for 10 to 15 ms (e.g. 1840 A peak).

The protection settings must effectively protect the motor, notably via a suitable thermal-relay trip class, but let the peak starting current through.



ComPacT NSX Motor Protection Motor-Feeder Solutions

ComPacT NSX motor circuit breakers are designed for motor-feeder solutions using:

- Three devices, including an MA or 1.3 M magnetic-only trip unit
- Two devices including a 2 M or 6 E-M electronic trip unit.

They are designed for use with contactors in the AC-3 utilization category (80 % of all cases) and they ensure type 2 coordination with the contactor.

For the AC-4 utilization category, the difficult conditions generally make it necessary to oversize the protection circuit breaker with respect to the AC-3 category.

ComPacT NSX Motor-Protection Range

ComPacT NSX trip units can be used to create motor-feeder solutions comprising two or three devices. The protection devices are designed for continuous duty at 65 °C.





Three-device solutions

- 1 NSX circuit breaker with an MA or MicroLogic 1.3 M trip unit
- 1 contactor
- 1 thermal relay

Two-device solutions

- 1 ComPacT NSX circuit breaker
 - With a MicroLogic 2.2 M or 2.3 M electronic trip unit
 - With a MicroLogic 6 E-M electronic trip unit. This version offers additional protection and power meter functions
- 1 contactor

B

Type of motor protection		3 devices		2 devices	
ComPacT NSX circuit breaker		NSX100/160/250	NSX400/630	NSX100 to 630	
Trip unit	Type 2 coordination with Type Technology	Contactor + thermal relay MA Magnetic 	MicroLogic 1.3 M Electronic 	MicroLogic 2 M Electronic 	MicroLogic 6 E-M Electronic 
Thermal relay	Separate	<input checked="" type="checkbox"/>	<input checked="" type="checkbox"/>		
	Built-in, class			<input checked="" type="checkbox"/>	<input checked="" type="checkbox"/>
	5			<input checked="" type="checkbox"/>	<input checked="" type="checkbox"/>
	10			<input checked="" type="checkbox"/>	<input checked="" type="checkbox"/>
	20			<input checked="" type="checkbox"/>	<input checked="" type="checkbox"/>
	30				<input checked="" type="checkbox"/>
Protection functions of ComPacT NSX circuit breaker					
Short-circuits		<input checked="" type="checkbox"/>	<input checked="" type="checkbox"/>	<input checked="" type="checkbox"/>	<input checked="" type="checkbox"/>
Overloads				<input checked="" type="checkbox"/>	<input checked="" type="checkbox"/>
Insulation faults	Ground-fault				<input checked="" type="checkbox"/>
Special motor functions	Phase unbalance			<input checked="" type="checkbox"/>	<input checked="" type="checkbox"/>
	Locked rotor				<input checked="" type="checkbox"/>
	Under-load				<input checked="" type="checkbox"/>
	Long start				<input checked="" type="checkbox"/>
Built-in power meter functions					
I, U, energy					<input checked="" type="checkbox"/>
Operating assistance					
Counters (cycles, trips, alarms, hours)					<input checked="" type="checkbox"/>
Contact-wear indicator					<input checked="" type="checkbox"/>
Load profile and thermal image					<input checked="" type="checkbox"/>

> Discover Schneider Electric specific Motor Protection Offer:

TeSys GV



MKTED210011EN

ComPacT NSX Motor Protection MA Instantaneous Trip Units

MA magnetic trip units are used in 3 devices motor-feeder solutions. They can be mounted on all ComPacT NSX100/160/250 circuit breakers with performance levels B/F/N/H/S/L . They provide short-circuit protection for motors up to 110 kW at 400 V.

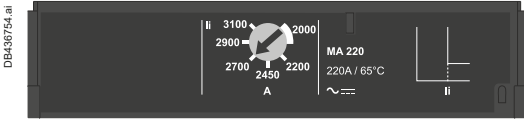

MA Magnetic Trip Units

In distribution applications, circuit breakers equipped with MA magnetic-only trip units are used for:

- Short-circuit protection of secondary windings of LV/LV transformers with overload protection on the primary side
- As an alternative to a switch-disconnector at the head of a switchboard in order to provide short-circuit protection.

Their main use is however for motor protection applications, in conjunction with a thermal relay and a contactor or motor starter.

Protection

Magnetic Protection (Ii)

Short-circuit protection with an adjustable pick-up Ii that initiates instantaneous tripping if exceeded.

- $I_i = I_n \times \dots$ set in amps on an adjustment dial covering the range 6 to 14 x In for 2.5 to 100 A ratings or 9 to 14 In for 150 to 220 A ratings.

Protection Versions

- 3-pole (3P 3D): 3-pole frame (3P) with detection on all 3 poles (3D)
- 4-pole (4P 3D): 4-pole frame (4P) with detection on 3 poles (3D)

B

Magnetic Trip Units MA 2.5 to 220

	Ratings (A)	In at 65 °C [1]	2.5	6.3	12.5	25	50	100 [1]	150	220
Circuit breaker	ComPacT NSX100	ComPacT NSX100	●	●	●	●	●	●	-	-
	ComPacT NSX160	ComPacT NSX160	-	-	-	●	●	●	●	-
	ComPacT NSX250	ComPacT NSX250	-	-	-	-	-	●	●	●
Instantaneous magnetic protection										
Pick-up (A) accuracy ±20 %	$I_i = I_n \times \dots$		Adjustable from 6 to 14 x In (settings 6, 7, 8, 9, 10, 11, 12, 13, 14)						Adjustable from 9 to 14 x In (settings 9, 10, 11, 12, 13, 14)	
Time delay (ms)	tm		fixed							

[1] MA100 3P adjustable from 6 to 14 x In.
MA100 4P adjustable from 9 to 14 x In.

Note: All the trip units have a transparent lead-sealable cover that avoids access to the adjustment dials.

ComPacT NSX Motor Protection

MicroLogic 1.3 M Instantaneous Trip Units

MicroLogic 1.3 M trip units are used in 3 devices motor-feeder solutions on ComPacT NSX400/630 circuit breakers with performance levels B/F/N/H/S/L.

They provide short-circuit protection for motors up to 250 kW at 400 V.

They also provide the benefits of electronic technology:

- Accurate settings
- Tests
- "Ready" LED.

MicroLogic 1.3 M Trip Units

Circuit breakers with a MicroLogic 1.3 M trip unit are combined with a thermal relay and a contactor.

Protection

Settings are made using a dial.

Short-Circuits: Short-Time Protection (Isd)

Protection with an adjustable pick-up Isd. There is a very short delay to let through motor starting currents.

- Isd is set in amperes from 5 to 13 x In, as follows:
 - From 1600 to 4160 A for the 320 A rating
 - From 2500 to 6500 A for the 500 A rating

Short-Circuits: Non-Adjustable Instantaneous Protection (Ii)

Instantaneous protection with non-adjustable pick-up Ii.

Protection Version

- 3-pole (3P 3D): 3-pole frame (3P) equipped with detection on all 3 poles (3D).

Indications

Front indications

- Green "Ready" LED: the MicroLogic current transformer is continuously monitored by automatic tests. The MicroLogic will trip if the current transformer malfunctions. The blinking green "Ready" LED indicates that protection links—from CTs to electronics to the minitop release—are fully operational with no test kit required. This feature works from 15 to 50 A, depending on the device. For lower loads, a pocket battery can be used to activate the indication.

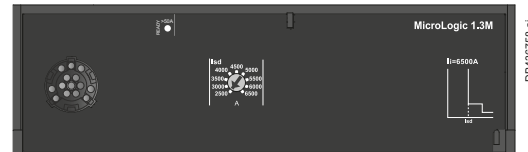

MicroLogic 1.3 M

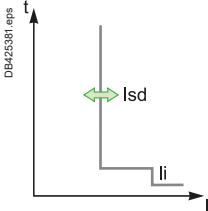

	Ratings (A)	In at 65 °C [1]	320	500
Circuit breaker		ComPacT NSX400	●	-
		ComPacT NSX630	●	●
S Short-time protection				
Pick-up (A) accuracy ±15 %	Isd	Adjustable directly in amps		
		9 settings: 1600, 1920, 2240, 2560, 2880, 3200, 3520, 3840, 4160 A		9 settings: 2500, 3000, 3500, 4000, 4500, 5000, 5500, 6000, 6500 A
Time delay (ms)	tsd	Non-adjustable		
		Non-tripping time: 10		
		Maximum break time: 60		
I Instantaneous protection				
Pick-up (A) accuracy ±15 %	Ii non-adjustable	4800		6500
		Non-tripping time: 0		
		Maximum break time: 30 ms		

[1] Motor standards require operation at 65 °C. Circuit-breaker ratings are derated to take this requirement into account (see pages E-13 to E-16).

B

ComPacT NSX Motor Protection MicroLogic 2.2/2.3 M Electronic Trip Units

MicroLogic 2.2/2.3 M trip units provide built-in thermal and magnetic protection. They are used in 2 devices motor-feeder solutions on ComPacT NSX100 to 630 circuit breakers with performance levels B/F/N/H/S/L. They provide protection for motors up to 315 kW at 400 V against:

- Short-circuits
- Overloads with selection of a trip class (5, 10 or 20)
- Phase unbalance.

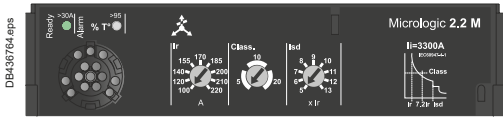

Circuit breakers with a MicroLogic 2.2/2.3 M trip unit include protection similar to an inverse-time thermal relay. They are combined with a contactor.

Protection

Settings are made using a dial.

L Overloads (or thermal protection): Long-time protection and trip class (Ir)
Inverse-time thermal protection against overloads with adjustable pick-up Ir. Settings are made in amperes. The tripping curve for the long-time protection, which indicates the time delay **tr** before tripping, is defined by the selected trip class.

Trip class (class)

The class is selected as a function of the normal motor starting time.

- Class 5: starting time less than 5 s.
- Class 10: starting time less than 10 s.
- Class 20: starting time less than 20 s.

For a given class, it is necessary to check that all motor-feeder components are sized to carry the 7.2 Ir starting current without excessive temperature rise during the time corresponding to the class.

S Short-circuits: Short-time protection (Isd)

Protection with an adjustable pick-up Isd. There is a very short delay to let through motor starting currents.

I Short-circuits: Non-adjustable instantaneous protection (Ii)

Instantaneous protection with non-adjustable pick-up Ii.

Phase unbalance or phase loss (Iunbal) (⚡)

This function opens the circuit breaker if a phase unbalance occurs:

- That is greater than the 30 % fixed pick-up **Iunbal**
- Following the non-adjustable time delay **tunbal** equal to:
 - 0.7 s during starting
 - 4 s during normal operation.

Phase loss is an extreme case of phase unbalance and leads to tripping under the same conditions.

Indications

Front indications

- Green "Ready" LED: the MicroLogic current transformer is continuously monitored by automatic tests. The MicroLogic will trip if the current transformer malfunctions. The blinking green "Ready" LED indicates that protection links—from CTs to electronics to the minitop release—are fully operational with no test kit required. This feature works from 15 to 50 A, depending on the device. For lower loads, a pocket battery can be used to activate the indication.
- Red alarm LED for motor operation: goes ON when the thermal image of the rotor and stator is greater than 95 % of the permissible temperature rise.

Remote indications via SDTAM module

ComPacT NSX devices with a MicroLogic 2 can be equipped with an SDTAM module dedicated to motor applications for:

- A contact to indicate circuit-breaker overload
- A contact to open the contactor. In the event of a phase unbalance or overload, this output is activated 400 ms before circuit-breaker tripping to open the contactor and avoid circuit breaker tripping.

This module takes the place of the MN/MX coils and an OF contact.

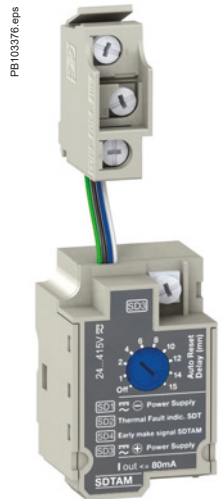

SDTAM remote indication relay module with its terminal block

Note: All the trip units have a transparent lead-sealable cover that avoids access to the adjustment dials.



ComPacT NSX Motor Protection

MicroLogic 2.2/2.3 M Electronic Trip Units

MicroLogic 2.2/2.3 M

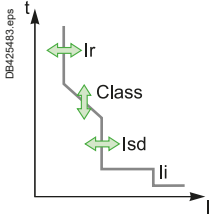

Ratings (A)	In at 65 °C ^[1]	25	50	100	150	220	320	500
Circuit breaker	ComPacT NSX100	●	●	●	-	-	-	-
	ComPacT NSX160	●	●	●	●	-	-	-
	ComPacT NSX250	●	●	●	●	●	-	-
	ComPacT NSX400	-	-	-	-	-	●	-
	ComPacT NSX630	-	-	-	-	-	●	●

L Overloads (or thermal protection): Long-time protection and trip class

Pick-up (A) tripping between 1.05 and 1.20 Ir	Ir	Value depending on trip unit rating (In) and setting on dial								
In = 25 A	Ir =	12	14	16	18	20	22	23	24	25
In = 50 A	Ir =	25	30	32	36	40	42	45	47	50
In = 100 A	Ir =	50	60	70	75	80	85	90	95	100
In = 150 A	Ir =	70	80	90	100	110	120	130	140	150
In = 220 A	Ir =	100	120	140	155	170	185	200	210	220
In = 320 A	Ir =	160	180	200	220	240	260	280	300	320
In = 500 A	Ir =	250	280	320	350	380	400	440	470	500

Trip class as per IEC 60947-4-1		5	10	20						
---------------------------------	--	---	----	----	--	--	--	--	--	--

Time delay (s) depending on selected trip class	tr	1.5 x Ir	6 x Ir	7.2 x Ir	120	240	480	for warm motor	6.5	13.5	26	for cold motor	5	10	20	for cold motor
---	----	----------	--------	----------	-----	-----	-----	----------------	-----	------	----	----------------	---	----	----	----------------

Thermal memory		20 minutes before and after tripping									
----------------	--	--------------------------------------	--	--	--	--	--	--	--	--	--

Cooling fan		Non-adjustable - motor self-cooled									
-------------	--	------------------------------------	--	--	--	--	--	--	--	--	--

S₀ Short-circuits: Short-time protection with fixed time delay

Pick-up (A) accuracy ±15 %	Isd = Ir x ...	5	6	7	8	9	10	11	12	13
----------------------------	----------------	---	---	---	---	---	----	----	----	----

Time delay (ms)	tsd	Non-adjustable								
-----------------	-----	----------------	--	--	--	--	--	--	--	--

	Non-tripping time	10								
--	-------------------	----	--	--	--	--	--	--	--	--

	Maximum break time	60								
--	--------------------	----	--	--	--	--	--	--	--	--

I Short-circuits: Non-adjustable instantaneous protection

Pick-up (A) accuracy ±15 %	Ii non-adjustable	425	750	1500	2250	3300	4800	6500
----------------------------	-------------------	-----	-----	------	------	------	------	------

Time delay (ms)	Non-tripping time	0								
-----------------	-------------------	---	--	--	--	--	--	--	--	--

	Maximum break time	30								
--	--------------------	----	--	--	--	--	--	--	--	--

Phase unbalance or phase loss

Pick-up (A) accuracy ±20 %	Iunbal in % average current ^[2]	> 30 %								
----------------------------	--	--------	--	--	--	--	--	--	--	--

Time delay (s)	Non-adjustable	0.7 s during starting								
----------------	----------------	-----------------------	--	--	--	--	--	--	--	--

		4 s during normal operation								
--	--	-----------------------------	--	--	--	--	--	--	--	--

[1] Motor standards require operation at 65 °C. Circuit-breaker ratings are derated to take this requirement into account (see pages E-13 to E-16).

[2] The unbalance measurement takes into account the most unbalanced phase with respect to the average current.



ComPacT NSX Motor Protection

MicroLogic 6 E-M Electronic Trip Units

MicroLogic 6 E-M is used in 2 devices motor-feeder solutions. It provides the same protection as MicroLogic 2 M:

- Short-circuits
- Overloads with selection of the same trip classes (5, 10 or 20), plus trip class 30 for starting of machines with high inertia.

In addition, it offers specific motor-protection functions that can be set via the keypad.



Protection

The protection functions can be fine-adjusted via the keypad . Access to setting modifications via the keypad is protected by a locking function that is controlled by a microswitch . The lock is activated automatically if the keypad is not used for 5 minutes. Access to the microswitch is protected by a transparent lead-sealable cover. It is possible to scroll through settings and measurements with the cover closed.

Overloads (or thermal), class and short-circuits

The long-time, short-time and instantaneous functions are identical to those of MicroLogic 2 M.

In addition, there is trip class 30 for long-time protection and a setting for self-cooled or fan-cooled motors ().

Ground-fault protection (I_g)

Residual type ground-fault protection with an adjustable pick-up **I_g** (with Off position) and adjustable time delay **t_g**.

Phase unbalance or phase loss

This function opens the circuit breaker if a phase unbalance occurs:

- That is greater than the **I-unbal** pick-up that can be fine-adjusted from 10 to 40 % (30 % by default)
- Following the **tunbal** time delay that is:
 - 0.7 s during starting
 - Adjustable from 1 to 10 seconds (4 seconds by default) during normal operation.

Phase loss is an extreme case of phase unbalance and leads to tripping under the same conditions.

Locked rotor (I-jam)

This function detects locking of the motor shaft caused by the load.

During motor starting (see page B-40), the function is disabled.

During normal operation, it causes tripping:

- Above the **I-jam** pick-up that can be fine-adjusted from 1 to 8 x I_r
- In conjunction with the **tjam** time delay that can be adjusted from 1 to 30 seconds

Under-load (I-und)

This function detects motor no-load operation due to insufficient load (e.g. a drained pump). It detects phase undercurrent.

During motor starting (see page B-40), the function is always enabled.

During normal operation, it causes tripping:

- Below the **I-und** pick-up that can be fine-adjusted from 0.3 to 0.9 x I_r
- In conjunction with the **tund** time delay that can be adjusted from 1 to 200 seconds.

Long starts (I-long)

This protection supplements thermal protection (class).

It is used to better adjust protection to the starting parameters.

It detects abnormal motor starting, i.e. when the starting current remains too high or too low with respect to a pick-up value and a time delay.

It causes tripping:

- In relation with a **Ilong** pick-up that can be fine-adjusted from 1 to 8 x I_r
- In conjunction with the **tlong** time delay that can be adjusted from 1 to 200 seconds (see "long starts" page B-40).

B

Note: All the trip units have a transparent lead-sealable cover that avoids access to the adjustment dials.

ComPacT NSX Motor Protection

MicroLogic 6 E-M Electronic Trip Units

Display of Type of Fault

On a fault trip, the type of fault (Ir, Isd, Ii, Ig, Iunbal, Ijam), the phase concerned and the interrupted current are displayed.

Indications

Front indications

- Green "Ready" LED: the MicroLogic current transformer is continuously monitored by automatic tests. The MicroLogic will trip if the current transformer malfunctions. The blinking green "Ready" LED indicates that protection links—from CTs to electronics to the minitop release—are fully operational with no test kit required. This feature works from 15 to 50 A, depending on the device. For lower loads, a pocket battery can be used to activate the indication.
- Red alarm LED for motor operation: goes ON when the thermal image of the rotor or stator is greater than 95% of the permissible temperature rise.

Remote indications via SDTAM or SDx module

For more information on SDTAM and SDx, see the description on [page C-35](#).

MicroLogic 6.2/6.3 E-M

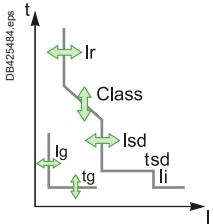

Ratings (A)	In at 65 °C [1]	25	50	80	150	220	320	500			
Circuit breaker	ComPacT NSX100	●	●	●	-	-	-	-			
	ComPacT NSX160	●	●	●	●	-	-	-			
	ComPacT NSX250	●	●	●	●	●	-	-			
	ComPacT NSX400	-	-	-	-	-	●	-			
	ComPacT NSX630	-	-	-	-	-	●	●			
L Overloads: Long-time protection											
Pick-up (A)	Ir	Dial setting							Value depending on trip-unit rating (In) and setting on dial		
Tripping between 1.05 and 1.20 Ir	In = 25 A	Ir =	12	14	16	18	20	22	23	24	25
	In = 50 A	Ir =	25	30	32	36	40	42	45	47	50
	In = 80 A	Ir =	35	42	47	52	57	60	65	72	80
	In = 150 A	Ir =	70	80	90	100	110	120	130	140	150
	In = 220 A	Ir =	100	120	140	155	170	185	200	210	220
	In = 320 A	Ir =	160	180	200	220	240	260	280	300	320
In = 500 A	Ir =	250	280	320	350	380	400	440	470	500	
		Keypad setting	Fine adjustments in 1 A steps below maximum value defined by dial setting								
Trip class as per IEC 60947-4-1			5	10	20	30					
Time delay (s)	tr	1.5 x Ir	120	240	480	720	for warm motor				
depending on selected trip class		6 x Ir	6.5	13.5	26	38	for cold motor				
		7.2 x Ir	5	10	20	30	for cold motor				
Thermal memory			20 minutes before and after tripping								
Cooling fan			Settings for self-cooled or fan-cooled motors								
S₀ Short-circuits: Short-time protection with fixed time delay											
Pick-up (A) accuracy ±15 %	Isd = Ir x ...		5	6	7	8	9	10	11	12	13
Time delay	tsd		Non-adjustable								
	Non-tripping time		10 ms								
	Maximum break time		60 ms								
I Short-circuits: Non-adjustable instantaneous protection											
Pick-up (A) accuracy ±15 %	Ii non-adjustable		425	750	1200	2250	3300	4800	6500		
	Non-tripping time		0 ms								
	Maximum break time		30 ms								
G Ground faults											
Pick-up (A) accuracy ±10 %	Ig = In x ...		Dial setting								
	In = 25 A	Ig =	0.6	0.6	0.6	0.6	0.7	0.8	0.9	1	Off
	In = 50 A	Ig =	0.3	0.4	0.5	0.6	0.7	0.8	0.9	1	Off
	In > 50 A	Ig =	0.2	0.3	0.4	0.5	0.6	0.7	0.8	1	Off
			Fine adjustments in 0.05 x In steps								
Time delay (ms)	tg		0	0.1	0.2	0.3	0.4				
	Non-tripping time		20	80	140	230	350				
	Maximum break time		80	140	200	320	500				

[1] Motor standards require operation at 65 °C. Circuit-breaker ratings are derated to take this requirement into account (see pages E-13 to E-16).

ComPacT NSX Motor Protection

MicroLogic 6 E-M Electronic Trip Units

MicroLogic 6.2 E M/6.3 E M

Phase unbalance or phase loss

Pick-up (A) accuracy $\pm 20\%$	lunbal = in % average current ^[1]	adjustable from 10 to 40 %, default setting = 30 % fine adjustments in 1 % steps using the keypad activated during motor starting
Time delay (s)	tunbal	0.7 s during starting 1 to 10 seconds during normal operation, default setting = 4 seconds fine adjustments in 1 s steps using the keypad

Locked rotor

Pick-up (A) accuracy $\pm 10\%$	ljam = $I_r \times \dots$	1 x 8 I_r with Off position, default setting = Off fine adjustments in 0.1 x I_r steps using the keypad disabled during motor starting
Time delay (s)	tjam =	1 to 30 seconds fine adjustments in 1 s steps using the keypad, default setting = 5 s

Under-load (under-current)

Pick-up (A) accuracy $\pm 10\%$	lund = $I_r \times \dots$	0.3 x 0.9 I_r with Off position, default setting = Off Fine adjustments in $I_r \times 0.01$ steps using the EcoStruxure Power Commission software activated during motor starting
Time delay (s)	tund =	1 to 200 seconds fine adjustments in 1 s steps using the EcoStruxure Power Commission software, default setting = 10 s

Long starts

Pick-up (A) accuracy $\pm 10\%$	llong = $I_r \times \dots$	1 x 8 I_r with Off position, default setting = Off Fine adjustments in $I_r \times 0.1$ steps using the EcoStruxure Power Commission software activated during motor starting
Time delay (s)	tlong =	1 to 200 seconds fine adjustments in 1 s steps using the EcoStruxure Power Commission software, default setting = 10 s

[1] The unbalance measurement takes into account the most unbalanced phase with respect to the average current.

ComPacT NSX Motor Protection

Additional Technical Characteristics

Phase unbalance

An unbalance in three-phase systems occurs when the three voltages are not equal in amplitude and/or not displaced 120° with respect to each other. It is generally due to single-phase loads that are incorrectly distributed throughout the system and unbalance the voltages between the phases.

These unbalances create negative current components that cause braking torques and temperature rise in asynchronous machines, thus leading to premature ageing.

Phase loss

Phase loss is a special case of phase unbalance.

- During normal operation, it produces the effects mentioned above and tripping must occur after four seconds.
- During starting, the absence of a phase may cause motor reversing, i.e. it is the load that determines the direction of rotation. This requires virtually immediate tripping (0.7 seconds).

Starting time in compliance with the class (MicroLogic 2 M)

For normal motor starting, MicroLogic 2 M checks the conditions below with respect to the thermal-protection (long-time) pick-up I_r :

- Current > 10 % x I_r (motor-off limit)
- Overrun of 1.5 x I_r threshold, then return below this threshold before the end of a 10 s time delay.

If either of these conditions is not met, the thermal protection trips the device after a maximum time equal to that of the selected class.

Pick-up I_r must have been set to the current indicated on the motor rating plate.

Long starts (MicroLogic 6 E-M)

When this function is not activated, the starting conditions are those indicated above. When it is activated, this protection supplements thermal protection (class).

A long start causes tripping and is characterized by:

- Current > 10 % x I_r (motor-off limit) with:
 - Either overrun of the long-time pick-up (1 to 8 x I_r) without return below the pick-up before the end of the long-time time delay (1 to 200 s)
 - Or no overrun of the long-time pick-up (1 to 8 x I_r) before the end of the long-time time delay (1 to 200 s).

Pick-up I_r must have been set to the current indicated on the motor rating plate.

This protection should be coordinated with the selected class.

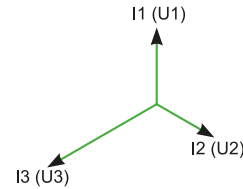

Unbalance of phase currents and voltages

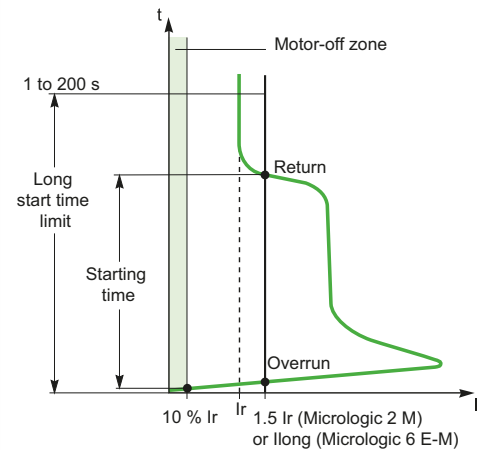

Motor starting and long starts

DB425429 eps

DB425430 eps

B

ComPacT NSX Measurement MicroLogic 5/6/7 E Electronic Trip Units

ComPacT NSX with its embedded current sensors handled by a microprocessor that operates independently of protection functions and MicroLogic 5/6/7 E is a PMD-DD Power Meter Device complying with IEC/EN 61557-12, Class 0.5 for voltage, Class 1 for current and Class 2 for active power and energy measurements.

Measures and Electrical Parameters Calculated by the MicroLogic 5/6/7 E Trip Units

Based on the measure of line currents, neutral current, phase to phase voltages and phase to neutral voltages, the MicroLogic 5/6/7 E trip units calculate and display all the parameters required to monitor any AC electrical power supply including power quality, power management and energy efficiency:

- RMS values of currents and voltages
- Active, reactive and apparent powers, active, reactive and apparent energies
- Power factor
- Frequency
- Unbalance on voltage and THD of voltages and currents
- Demand and maximum demand values

The maximum and minimum values are stored in the MicroLogic 5/6/7 E trip units non volatile memory. They are resettable from the embedded display, FDM display or a PC running EcoStruxure Power Commission software.

Demand and Maximum Demand Values

MicroLogic E also calculates demand current and power values. These calculations can be made using a block or sliding interval that can be set from 5 to 60 minutes in steps of 1 minute. The window can be synchronized with a signal sent via the communication system. Whatever the calculation method, the calculated values can be recovered on a PC via Modbus communication.

Ordinary spreadsheet software can be used to provide trend curves and forecasts based on this data. They will provide a basis for load shedding and reconnection operations used to adjust consumption to the subscribed power.

Electrical values can be displayed on the embedded HMI, a PC running EcoStruxure Power Commission software and on the FDM display unit.

They are refreshed every second.

The display on the embedded HMI is accessed by means of a contextual menu allowing to navigate easily through the electrical values. Alternatively a Quickview option allows to display the main basic values.

Optional external 24 Vdc supply module is required to process and display the measurements including energy counters for currents below 20 % of the rated current.

The phase to neutral voltages are available for 4 poles circuit breakers and 3 poles circuit breakers as well providing the connection of the MicroLogic 5/6 E to the neutral (ENVT). This connection is mandatory for an accurate active power measurement.

Neutral-Phase measurement is only possible on the 4-pole MicroLogic Vigi 7 E (not on the 3-pole).

No External Neutral connection on the MicroLogic Vigi 7 E.

Please refer to the user manual for more details concerning the wiring and the configuration of MicroLogic 5/6/7 E.

ComPacT NSX Measurement MicroLogic 5/6/7 E Electronic Trip Units

B

MicroLogic 5/6/7 E for Energy Management Functions

Active Power and Energy metering in ComPacT NSX with MicroLogic 5/6/7 E has been designed and tested to provide accuracy: **Class 2 according to IEC/EN 61557-12**. This standard specifies requirements for combined performance of measuring and monitoring devices that measure and monitor the electrical parameters within electrical distribution systems. It covers both devices with external sensors such as current and/or voltage transformers like stand alone power meter (PMD-S) and devices with embedded sensors (PMD-D) like circuit breakers.

In addition a list of available performance class for all relevant measurement functions is specified in IEC/EN 61557-12, in opposition to most other standards such as IEC 62053-2x series that are dealing only with active and reactive energy.

ComPacT NSX equipped with MicroLogic 5/6/7 E and its own embedded sensors is a Class 2 full chain measurement PMD-D device for active power and energy metering according to IEC/EN 61557-12.

PMD-D offer the benefit of avoiding uncertainty and variation due to external sensors and wiring.

IEC/EN 61557-12 standard defines three levels of uncertainty (intrinsic uncertainty, operating uncertainty, overall system uncertainty) that need to be checked to ensure accuracy class.

The uncertainty is the estimated amount or percentage by which a measured value may differ from the true value. According to IEC/EN 61557-12, the total uncertainty of a measurement, in general, depends on the instrument, the environment, and other elements to be considered.

Note: Requirements for Class 2 active power and energy in IEC/EN 61557-12 regarding limits of uncertainty due to variation of the current for different power factor, and limits of uncertainty due to influence quantities such as temperature are equivalent to IEC 62053-2x standards.

PMD-D - Embedded Sensors

Intrinsic uncertainty
Uncertainty under reference conditions



Operating uncertainty
+ measurement uncertainty according to IEC 61000-4-30
Variations due to influence quantities

Overall system uncertainty:
No additional error for PMD-D



PMD-S - External Sensors

Intrinsic uncertainty
Uncertainty under reference conditions



Operating uncertainty
+ measurement uncertainty according to IEC 61000-4-30
Variations due to influence quantities



Overall system uncertainty
Uncertainty and variations due to external sensors accuracy and to resistance of wires



PMD-D - Embedded sensors

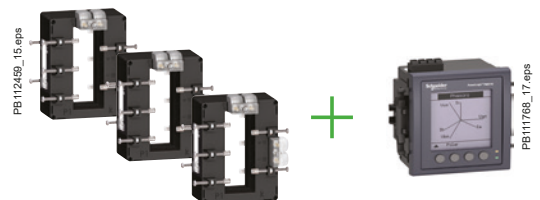

PMD-S - External sensors

ComPacT NSX Measurement MicroLogic 5/6/7 E Electronic Trip Units



Compliance with ISO 50001: Reliability and Repeatability Over Time of Energy Measurement

Scope and main requirements of ISO 50001:

ISO 50001 specifies requirements for systems and organization dedicated to energy management. This international standard defines rules and gives recommendations to achieve continual improvement of energy performance, including energy efficiency, energy use and consumption, measurements, documentation and reporting. Energy performance shall be monitored and significant deviations shall be investigated. It implies that the accuracy of the instruments used for this purpose remains stable throughout their entire operating life which ensures the repeatability of the measurements (ISO 50001, clause 4.6 and 4.6.1 Checking, monitoring, measurement and analysis).

In ComPacT NSX with MicroLogic 5/6/7 E, the metering and protection functions are designed to perform accurate and repeatable measurements during MicroLogic E life time, provided it's used in the specified environmental conditions as defined in ComPacT NSX User Guide. Current sensors and MicroLogic E are calibrated during circuit breaker manufacturing and are not supposed to be re-calibrated during this life time. In general, electronic instrument measuring electric parameters don't request any specific maintenance provided they are working within environmental specifications. Accuracy can be reduced in case of operation under exceptional conditions, lightning strikes, high temperature, high degree of humidity, this is why a periodic verification is recommended (please refer to the annex I of the AFNOR Document FD X30-147: Metrological maintenance recommendations, applicable to electrical and fluidic measurements).

IEC 60364-8-1 Clause 8.3.1.1 Requirement on Accuracy and Measuring Range

Scope and main requirements of IEC 60364-8-1:

IEC 60364-8-1 provides requirements and recommendations for the design, erection and verification of low voltage electrical installations including local production and storage of energy for optimizing the overall efficient use of electricity. It introduces recommendations for the design of an electrical installation within the framework of an energy efficiency management approach in order to get low electrical energy consumption and acceptable energy availability. It also specifies the accuracies of the measuring instruments involved in the functions of energy management such as:

- Energy usage analysis and optimization
- Contract optimization
- Cost allocation
- Efficiency assessment
- Energy usage trends assessment.

ComPacT NSX with MicroLogic 5/6/7 E complies with the requirements of IEC 60364-8-1 dedicated to the optimization of energy efficiency. It provides a range of measurements with accuracies required for complex energy efficiency approaches.

The table below from IEC 60364-8-1:2014 Clause 8.3.1.1 "Requirement on accuracy and measuring range" specifies the accuracies required for the measurements dedicated to cost management

	Incomer	ComPacT NSX main applications		Final distribution board
		Main LV switchboard	Intermediate distribution boards	
Measurement objectives for cost management	<ul style="list-style-type: none"> ■ Revenue metering ■ Bill checking ■ Energy usage analysis and optimization ■ Contract optimization ■ Regulatory compliance 	<ul style="list-style-type: none"> ■ Cost allocation ■ Energy usage analysis and optimization ■ Efficiency assessment ■ Contract optimization ■ Regulatory compliance 	<ul style="list-style-type: none"> ■ Cost allocation ■ Energy usage analysis and optimization ■ Efficiency assessment ■ Contract optimization ■ Regulatory compliance 	<ul style="list-style-type: none"> ■ Energy usage analysis and optimization ■ Energy usage trends assessment
Overall system accuracy of active energy measurement	In general, excellent accuracy, e.g. class 0.2 to class 1	In general, good accuracy, e.g. class 0.5 to class 2	In general, medium accuracy, e.g. class 1 to class 3	In general, reliable indication should be more important than accuracy

ComPacT NSX Measurement MicroLogic 5/6/7 E Electronic Trip Units



MicroLogic 5/6/7 integrated Power Meter functions			Type	Display	
			E	MicroLogic LCD	FDM display
Display of protection settings					
Pick-ups (A) and delays	Settings MicroLogic 5/6	I _r , t _r , I _{sd} , t _{sd} , I _i , I _g , t _g	●	●	-
	Settings MicroLogic Vigi 7 E [4]	I _r , t _r , I _{sd} , t _{sd} , I _i , I _{Δn} , Δt, I _{Δn} % pre-alarm	●	●	
Measurements					
Instantaneous rms measurements					
Currents (A)	Phases and neutral	I1, I2, I3, IN	●	●	●
	Average of phases	I _{avg} = (I1 + I2 + I3)/3	●	-	●
	Highest current of the 3 phases and neutral	I _{max} of I1, I2, I3, IN	●	●	●
	Ground fault (MicroLogic 6)	% I _g (pick-up setting)	●	●	●
	Earth leakage (MicroLogic Vigi 7 E)	% I _{Δn} (pick-up setting)	●		
	Highest Earth Leakage current	I _{Δn} max	●	-	-
	Current unbalance between phases	% I _{avg}	●	-	●
	Voltages (V)	Phase-to-phase	U12, U23, U31	●	●
Phase-to-neutral		V1N, V2N, V3N	●	●	●
Average of phase-to-phase voltages		U _{avg} = (U12 + U21 + U23)/3	●	-	●
Average of phase-to-neutral voltages		V _{avg} = (V1N + V2N + V3N)/3	●	-	●
Ph-Ph and Ph-N voltage unbalance		% U _{avg} and % V _{avg}	●	-	●
Phase sequence		1-2-3, 1-3-2	●	●	● [3]
Frequency (Hz)	Power system	f	●	-	●
Power	Active (kW)	P, total/per phase	●/●	●/-	●/●
	Reactive (kVAR)	Q, total/per phase	●/●	●/-	●/●
	Apparent (kVA)	S, total/per phase	●/●	●/-	●/●
	Power factor and cos φ (fundamental)	PF and cos φ, total and per phase	●	-	●
Maximeters/minimeters					
	Associated with instantaneous rms measurements	Reset via MicroLogic or FDM display unit	●	-	●
Energy metering					
Energy	Active (kWh), reactive (kvarh), apparent (kVAh)	Total since last reset Absolute or signed mode [1]	●	●	●
Demand and maximum demand values					
Demand current (A)	Phases and neutral	Present value on the selected window	●	-	●
		Maximum demand since last reset	●	-	●
Demand power	Active (kWh), reactive (kvarh), apparent (kVA)	Present value on the selected window	●	-	●
		Maximum demand since last reset	●	-	●
Calculation window	Sliding, fixed or com-synchronized	Adjustable from 5 to 60 minutes in 1 minute steps [2]	●	-	-
Power quality					
Total harmonic distortion (%)	Of voltage with respect to rms value	THDU, THDV of the Ph-Ph and Ph-N voltage	●	-	●
	Of current with respect to rms value	THDI of the phase current	●	-	●

[1] Absolute mode: E absolute = E out + E in; Signed mode: E signed = E out - E in.

[2] Available via the communication system only.

[3] FDM121 only.

[4] Two last I_{Δn} and Δt values are available as well as date of setting.

Additional technical characteristics

Measurement accuracy

Accuracies are those of the entire measurement system, including the sensors:

- Current: Class 1 as per IEC 61557-12
- Voltage: 0.5 %
- Power and energy: Class 2 as per IEC 61557-12
- Frequency: 0.1 %.

ComPacT NSX Diagnostics & Maintenance

MicroLogic 5/6/7 E Electronic Trip Units



MicroLogic built-in LCD display

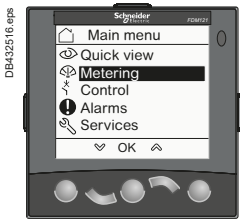

FDM121 display: navigation

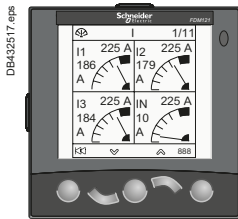

FDM121 display: current

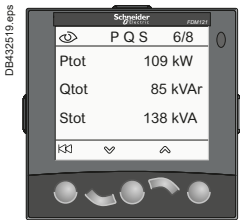

FDM121 display: power

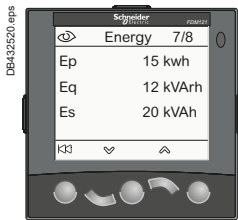

FDM121 display: consumption

Examples of operating-assistance screens on the FDM121 display unit

Personalized Alarms with Time-Stamping

Alarm types

The user can assign an alarm to all MicroLogic E measurements or events:

- Up to 12 alarms can be used together:
 - Two alarms are predefined and activated automatically:
 - MicroLogic 5: overload (Ir)
 - MicroLogic 6: overload (Ir) and ground fault (Ig)
 - MicroLogic Vigi 7 E: overload (Ir) and earth leakage fault (IΔn)
 - Thresholds, priorities and time delays can be set for ten other alarms.
- The same measurement can be used for different alarms to precisely monitor certain values, e.g. the frequency or the voltage
- Alarms can also be assigned to various states: phase lead/lag, four quadrants, phase sequence
- Selection of display priorities, with pop-up possibility
- Alarm time-stamping.

Alarm settings

Alarms cannot be set via the keypad or the FDM display unit. They are set via communication with the PC. Set-up includes the threshold, priority, activation delay before display and deactivation delay. It is also possible to reprogram the standard assignment for the two SDx relay outputs to user-selected alarms.

Alarm reading

Remote alarm indications.

- Reading on FDM display unit or on PC via the communication system.
- Remote indications via SDx relay with two output contacts for alarms.

Histories and Event Tables

MicroLogic E has histories and event tables that are always active.

Three types of time-stamped histories

- Tripping due to overruns of Ir, I_{sd}, I_l, I_g, IΔn: last 17 trips
- Alarms: last 10 alarms
- Operating events: last 10 events

Each history record is stored with:

- Indications in clear text in a number of user-selectable languages
- Time-stamping: date and time of event
- Status: pick-up/drop-out

Two types of time-stamped event tables

- Protection settings
- Minimizers/maximizers

Display of alarms and tables

The time-stamped histories and event tables may be displayed on a PC via the communication system.

Embedded memory

MicroLogic E has a non-volatile memory that registers all data on alarms, histories, event tables, counters and maintenance indicators even if power is lost.

Maintenance Indicators

MicroLogic E has indicators for, among others, the number of operating cycles, contact wear and operating times (operating hours counter) of the ComPacT NSX circuit breaker.

It is possible to assign an alarm to the operating cycle counter to plan maintenance. The various indicators can be used together with the trip histories to analyse the level of stresses the device has been subjected to.

The information provided by the indicators cannot be displayed on the MicroLogic LCD. It is displayed on the PC via the communication system.

Management of Installed Devices

Each circuit breaker equipped with a MicroLogic 5 or 6 or 7 trip unit can be identified via the communication system:

- Serial number
- Firmware version
- Hardware version
- Device name assigned by the user.

This information together with the previously described indications provides a clear view of the installed devices.



ComPacT NSX Diagnostics & Maintenance

MicroLogic 5/6/7 E Electronic Trip Units



B

MicroLogic 5/6/7 operating assistance functions			Type	Display	
			E	MicroLogic LCD	FDM display
Operating assistance					
Personalized alarms					
Settings	Up to 10 alarms assigned to all A and E measurements ^[2]		⊙	-	-
	Phase lead/lag, four quadrants, phase sequence, display priority selection ^[2]		⊙	-	-
Display	Alarms/tripping/test (Earth Leakage)		⊙	⊙/⊙/⊙	⊙/⊙/⊙
Remote indications	Activation of two dedicated contacts on SDx module		⊙	-	-
Time-stamped histories (ms)					
Trips (last 17)	Cause of tripping	Ir, Isd, li (MicroLogic 5, 6)	⊙	-	⊙
		Ig (MicroLogic 6)	⊙	-	⊙
		Ir, Isd, li, IΔn (MicroLogic Vigi 7 E)	⊙	-	⊙
		Phase fault	⊙	-	⊙
		Interrupted current value	⊙	-	⊙
Alarms (last 10)			⊙	-	⊙
Test Earth Leakage (last 10)	MicroLogic Vigi 7 E		⊙	-	⊙
Operating events (last 10)	Event types	Modification of protection setting by dial	⊙	-	⊙
		Opening of keypad lock	⊙	-	⊙
		Test via keypad	⊙	-	⊙
		Test via external tool	⊙	-	⊙
		Time setting (date and time)	⊙	-	⊙
		Reset for maximeter/minimeter and energy meter	⊙	-	⊙
Time stamping (date and time, text, status)			⊙	-	⊙
Time-stamped event tables					
Protection settings	Setting modified (value displayed)	Ir, tr, Isd, tsd, li, Ig, tg ^[2]	⊙	-	-
		Ir, tr, Isd, tsd, I, IΔn, Δt (MicroLogic Vigi 7 E) ^[2]	⊙	-	⊙
		Time-stamping	⊙	-	-
		Previous value	⊙	-	-
Min/Max	Values monitored	I1, I2, I3, IN	⊙	-	⊙
		U12, U23, U31, f	⊙	-	⊙
		Time-stamping of each value	⊙	-	⊙
		Current min/max value	⊙	-	⊙
Maintenance indicators					
Counter	Mechanical cycles ^[1]	Assignable to an alarm	⊙	-	⊙
		Electrical cycles ^[1]	⊙	-	⊙
		Trips	⊙	-	-
		Alarms	⊙	-	-
		Hours	⊙	-	-
Indicator	Contact wear	%	⊙	-	⊙
Load profile	Hours at different load levels	% of hours in four current ranges: 0-49 % In, 50-79 % In, 80-89 % In and ≥ 90 % In	⊙	-	⊙

[1] The BSCM Modbus SL/ULP is required for these functions.
 [2] Available via the communication system only.

Additional technical characteristics

Contact wear

Each time ComPacT NSX opens, the MicroLogic 5/6/7 trip unit measures the interrupted current and increments the contact-wear indicator as a function of the interrupted current, according to test results stored in memory. Breaking under normal load conditions results in a very slight increment. The indicator value may be read on the FDM121 display. It provides an estimation of contact wear calculated on the basis of the cumulative forces affecting the circuit breaker. When the indicator reaches 80 %, it is advised to replace the circuit breaker to ensure the availability of the protected equipment.

Circuit breaker load profile

MicroLogic 5/6/7 calculates the load profile of the circuit breaker protecting a load circuit. The profile indicates the percentage of the total operating time at four current levels (% of breaker In):

- 0 to 49 % In
- 50 to 79 % In
- 80 to 89 % In
- ≥ 90 % In. This information can be used to optimize use of the protected equipment or to plan ahead for extensions.

ComPacT NSX Diagnostics & Maintenance

MicroLogic 5/6/7 E Electronic Trip Units

Electrical power supply availability and reliability are the main critical issues affecting profitability and competitiveness. Outage management focuses on preventing, detecting, locating and clearing faults.

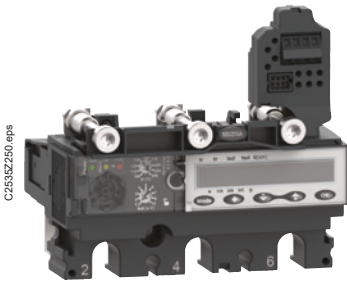

MicroLogic built-in LCD display

The MicroLogic 5/6/7 E control units perform in real time a high level of diagnostics on ComPacT NSX circuit breakers. They generate and store appropriate warnings, alarms and messages to help the users with maintenance and power restoration. This function complies with the following end user values:

- Prevent interruption of the power supply, to ensure continuity of operation, to preserve the asset from any damage and to support people safety.
- Reduce downtime resulting from an unexpected failure in the electrical distribution system, to be able to restart as quickly as possible after a trip.
- To keep the devices in good condition of operation.

Prevention of Power Supply Interruptions

Prevention of power supply interruptions is achieved by generation of warnings to the users, preventive operations of maintenance, and anticipation of device replacement.

By means of dedicated features, MicroLogic 5/6/7 E monitors the health of the circuit breaker and generates appropriate information to help the users in scheduling periodic checks and, if needed, anticipated replacement of devices.

ComPacT NSX Special Applications

Protection of Public Distribution Systems with MicroLogic 2-AB

MicroLogic AB trip units are used in public distribution systems to limit the current supplied according to the consumer's contract. They are available in 100, 160, 240 and 400 A ratings and are supplied with a lead-seal device to protect the settings.

ComPacT NSX circuit breakers equipped with MicroLogic AB trip units are installed as incoming devices for consumer installations connected to the public LV distribution system.

With respect to the utility, they have two functions.

- Consumption is limited to the contractual power level. If the limit is exceeded, a fast thermal-protection function trips the device at the head of the consumer's installation without the utility having to intervene.
- Total selectivity is ensured with the upstream fuses on the public distribution system in the event of a fault, overload or short-circuit in the consumer's installation, protecting the utility line.

In addition, they provide the consumer with:

- Protection for the installation as a whole, with the possibility of adding a Vigi earth-leakage protection module
- The possibility of downstream selectivity.

This type of ComPacT NSX is often used in conjunction with an ComPacT INV switch-disconnector located outside the consumer's building and providing the visible-break function.

This means the operator can directly see, through a transparent cover, the physical separation of the main contacts. The ComPacT INV range is also suitable for isolation with positive contact indication.

This means utility operators can work on the service-connection unit after isolating it from the upstream line.



DB4-367/66.ai



C2E/M/2D250.eps

ComPacT NSX with MicroLogic 2 AB

B

ComPacT NSX Special Applications

Protection of Public Distribution Systems with MicroLogic 2-AB



Protection

Settings are made using the adjustment dials with fine-adjustment possibilities and a lead-seal fixture.

Overloads: Long-time protection (I_r)

Inverse-time thermal protection against overloads with an adjustable current pick-up I_r and a very short, non-adjustable time delay t_r (15 seconds for $1.5 \times I_r$).

Short-circuits: Short-time protection (I_{sd}) with fixed time delay

Short-circuit protection with an adjustable pick-up I_{sd} . The short-time pick-up values are high enough to avoid nuisance tripping in the event of transient current spikes.

Short-circuits: Non-adjustable instantaneous protection

Instantaneous short-circuit protection with a fixed pick-up.

Neutral protection

Available on four-pole circuit breakers only. Neutral protection may be set using a three-position switch:

- 4P 3D: neutral unprotected
- 4P 3D + N/2: neutral protection at half the value of the phase pick-up, i.e. $0.5 \times I_r$
- 4P 4D: neutral fully protected at I_r .

Indications

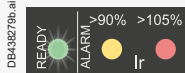

Front indications

- Green "Ready" LED: the MicroLogic current transformer is continuously monitored by automatic tests. The MicroLogic will trip if the current transformer malfunctions. The blinking green "Ready" LED indicates that protection links—from CTs to electronics to the minitop release—are fully operational with no test kit required. This feature works from 15 to 50 A, depending on the device. For lower loads, a pocket battery can be used to activate the indication.
- Orange overload pre-alarm LED: steady on when $I > 90\% I_r$.
- Red overload LED: steady on when $I > 105\% I_r$.

Remote indications

An SDx relay module installed inside the circuit breaker can be used to remote the overload-trip signal. This module receives the signal from the MicroLogic electronic trip unit via an optical link and makes it available on the terminal block. The signal is cleared when the circuit breaker is closed.

The module is described in detail in the section dealing with accessories [page C-35](#).



SDx remote indication relay module with its terminal block

B

ComPacT NSX Special Applications

Protection of Public Distribution Systems with MicroLogic 2-AB

MicroLogic 2.2/2.3 AB

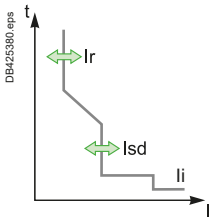

Ratings (A)	In at 40 °C ⁽¹⁾	100	160	240	400
Circuit breaker	ComPacT NSX100	●	-	-	-
	ComPacT NSX160	●	●	-	-
	ComPacT NSX250	●	●	●	-
	ComPacT NSX400	-	-	-	●
	ComPacT NSX630	-	-	-	●

L Long-time protection																																					
Pick-up (A) tripping between 1.05 and 1.20 Ir	<p>Ir Value depending on trip unit rating (In) and setting on dial</p> <table border="1"> <tr> <td>In = 100 A</td> <td>Ir = 40</td> <td>40</td> <td>50</td> <td>60</td> <td>70</td> <td>80</td> <td>90</td> <td>100</td> </tr> <tr> <td>In = 160 A</td> <td>Ir = 90</td> <td>100</td> <td>110</td> <td>120</td> <td>130</td> <td>140</td> <td>150</td> <td>160</td> </tr> <tr> <td>In = 240 A</td> <td>Ir = 140</td> <td>150</td> <td>160</td> <td>170</td> <td>180</td> <td>200</td> <td>220</td> <td>240</td> </tr> <tr> <td>In = 400 A</td> <td>Ir = 260</td> <td>280</td> <td>300</td> <td>320</td> <td>340</td> <td>360</td> <td>380</td> <td>400</td> </tr> </table>	In = 100 A	Ir = 40	40	50	60	70	80	90	100	In = 160 A	Ir = 90	100	110	120	130	140	150	160	In = 240 A	Ir = 140	150	160	170	180	200	220	240	In = 400 A	Ir = 260	280	300	320	340	360	380	400
In = 100 A	Ir = 40	40	50	60	70	80	90	100																													
In = 160 A	Ir = 90	100	110	120	130	140	150	160																													
In = 240 A	Ir = 140	150	160	170	180	200	220	240																													
In = 400 A	Ir = 260	280	300	320	340	360	380	400																													
Time delay (s)	<p>tr Non-adjustable</p> <table border="1"> <tr> <td>1.5 Ir</td> <td>15</td> </tr> <tr> <td>6 Ir</td> <td>0.5</td> </tr> <tr> <td>7.2 Ir</td> <td>0.35</td> </tr> </table>	1.5 Ir	15	6 Ir	0.5	7.2 Ir	0.35																														
1.5 Ir	15																																				
6 Ir	0.5																																				
7.2 Ir	0.35																																				
Thermal memory	20 minutes before and after tripping																																				

S _n Short-time protection with fixed time delay										
Pick-up (A) accuracy ±10 %	<p>Isd = Ir x ...</p> <table border="1"> <tr> <td>1.5</td> <td>2</td> <td>3</td> <td>4</td> <td>5</td> <td>6</td> <td>7</td> <td>8</td> <td>10</td> </tr> </table>	1.5	2	3	4	5	6	7	8	10
1.5	2	3	4	5	6	7	8	10		
Time delay (ms)	<p>tsd Non-adjustable: 20</p> <table border="1"> <tr> <td>Non-tripping time</td> <td>20</td> </tr> <tr> <td>Maximum break time</td> <td>80</td> </tr> </table>	Non-tripping time	20	Maximum break time	80					
Non-tripping time	20									
Maximum break time	80									

I Non-adjustable instantaneous protection					
Pick-up (A) accuracy ±15 %	<p>Ii non-adjustable</p> <table border="1"> <tr> <td>1500</td> <td>1600</td> <td>2880</td> <td>4800</td> </tr> </table>	1500	1600	2880	4800
1500	1600	2880	4800		
Time delay (ms)	<table border="1"> <tr> <td>Non-tripping time</td> <td>10</td> </tr> <tr> <td>Maximum break time</td> <td>50</td> </tr> </table>	Non-tripping time	10	Maximum break time	50
Non-tripping time	10				
Maximum break time	50				

[1] If the trip units are used in high-temperature environments, the MicroLogic setting must take into account the thermal limitations of the circuit breaker. See the temperature derating table.

Technical details

Advantages of the AB trip unit

- Controls the power drawn with respect to contractual power levels. If the contractual level is overrun, the circuit breaker opens and the consumer is not billed excess costs.
- If a short-circuit occurs, the circuit breaker opens and the upstream HRC fuses on utility lines are not affected. No expensive utility servicing is billed to the consumer.

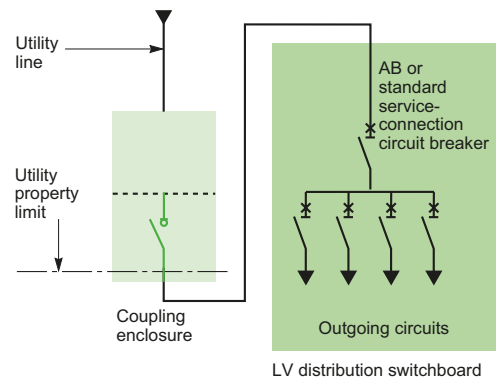

Consumer connection diagram

ComPacT NSX Special Applications

ComPacT NSX MicroLogic Vigi 4-AB Trip Unit with Embedded Earth Leakage Protection

The ComPacT NSX range for public distribution is now complemented with a new type of MicroLogic AB trip unit including both circuit protection and earth leakage protection. It means that the earth leakage protection, previously located within the VigiPacT add-on, will be embedded within the existing size of the MicroLogic AB trip unit.

MicroLogic Vigi 4-AB

ComPacT ELCB ⁽¹⁾ equipped with that "new" earth leakage trip unit MicroLogic AB are installed as an incoming device for installation connected with the public LV distribution system. With respect to the utility requirement, it ensures the same functions as the standard circuit breaker: limitation of consumption, selectivity upstream and downstream, combination with ComPacT INV to ensure the visible break or positive contact indication.

Short Circuit and Overload Protections

Settings are made using the rotary dial with fine adjustment capabilities and lead-seal fixture.

Overload: Long-Time Protection (I_r)

Inverse time protection against overload with an adjustable current pick-up I_r set using a dial and a very short non-adjustable time delay t_r (15 seconds at 1.5 I_r).

Short-Circuit: Short-Time Protection with Fixed Time Delay (I_{sd})

That protection is set with an adjustable pick-up I_{sd}. The short time pick-up values are high enough to avoid nuisance tripping in the event of transient current spikes.

Short Circuit: Non-Adjustable Instantaneous Protection (with a Fix Pick-up)

Neutral Protection

Available on four-pole ComPacT NSX MicroLogic Vigi 4-AB only, the neutral protection may be set using the dedicated coding wheel to meet the following configurations: 4P 3D, 4P 3D + N/2 or 4P 4D. (same as for the MicroLogic 2-AB)

Earth Leakage Protections

Adjustable leakage threshold (I_{Δn}) and adjustable time threshold (Δt) by using the two dials on the green area of the trip unit.

The ComPacT NSX MicroLogic Vigi 4-AB, embedding a MicroLogic AB can only be "Trip" type, the "Alarm" version (as for MicroLogic Vigi 4 and 7 E) doesn't exist.

Power Supply

The trip unit is self supplied, and so does not need any external source. It works even when fed by 2 phases only!

Sensitivity I_{Δn} (A)

- Type A: 30mA - 100mA - 300mA - 500mA - 1A - 3A - 5A (for the ratings 100 to 240A)
- Type A: 300mA - 500mA - 1A - 3A - 5A - 10A (for the rating 400A)

Caution: "OFF" setting of I_{Δn} is possible, it cancels the earth leakage protection, in that case, the ComPacT NSX MicroLogic Vigi 4-AB behaves as a standard circuit breaker. "OFF" position is located on the highest side of the coding wheel.

Intentional Delay Δt (S)

Case I_{Δn} = 30mA: 0 sec (whatever the setting)

Case I_{Δn} > 30mA: 0 – 60ms – 150ms – 500ms – 1sec (by setting)

Operated Voltage

200 to 440 VAC (only) – 50/60 Hz

Operating Safety

The earth leakage protection is a user safety device. It must be regularly tested using the test button (T) that simulates a real current leakage within the toroid.

When I_{Δn} is set on the OFF position, press the T will cancel any test.

As for standard circuit breaker, the circuit breaker with MicroLogic Vigi 4-AB can be reset after any fault by operating an OFF/ON procedure.

C254FB250.eps

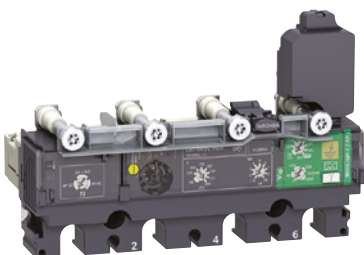

MicroLogic Vigi 4.2-AB trip unit

ComPacT NSX Special Applications

ComPacT NSX MicroLogic Vigi 4-AB Trip Unit with Embedded Earth Leakage Protection

Indications

Front Indications

- Green "Ready" LED: the MicroLogic current transformer is continuously monitored by automatic tests. The MicroLogic will trip if the current transformer malfunctions. The blinking green "Ready" LED indicates that protection links—from CTs to electronics to the minitop release—are fully operational with no test kit required. This feature works from 15 to 50 A, depending on the device. For lower loads, a pocket battery can be used to activate the indication.
- Orange overload pre-alarm LED: steady ON when $I > 90\%$ Ir.
- Red overload LED: steady ON when $I > 105\%$ Ir.
- Yellow Screen: indicates an earth leakage fault (reset when the device is operated OFF/ON).

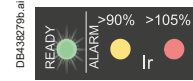

Alarming and Fault Differentiation

- An overload trip signal can be remotely available by installing an SDx relay module inside the circuit breaker.
- An earth leakage pre-alarm can be remotely available by installing an SDx module, only on the ComPacT NSX MicroLogic Vigi 4-AB.

This module receives the signal from the MicroLogic electronic trip unit via an optical link and makes it available on the terminal block. The signal is reset when the breaker is operated.

B

MicroLogic Vigi 4-AB (Earth Leakage "Trip" Version Only)

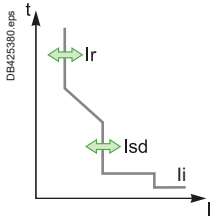

Ratings (A)	In at 40 °C [1]	100	160	240	400
Circuit breaker	ComPacT NSX100	●			
	ComPacT NSX160	●	●		
	ComPacT NSX250	●	●	●	
	ComPacT NSX400				●
	ComPacT NSX630				●

L Long-time protection											
Pick-up (A)	Ir	Value depending on the rating (In) and the dial setting (9 positions)									
tripping between 1.05 and 1.20 Ir	In = 100 A	Io =	40	40	40	50	60	70	80	90	100
	In = 160 A	Io =	90	90	100	110	120	130	140	150	160
	In = 240 A	Io =	140	140	150	160	170	180	200	220	240
	In = 400 A	Io =	260	260	280	300	320	340	360	380	400
Time delay (s)	tr	Non-adjustable									
accuracy 0 to -20%	at	1.5 x Ir	tr = 15 s								
	at	6 x Ir	tr = 0.5 s								
	at	7.2 x Ir	tr = 0.35 s								
Thermal memory	20 minutes before and after tripping										

S ₀ Short-time protection with fixed time delay											
Pick-up (A)	Isd = Ir x ...	1.5	2	3	4	5	6	7	8	10	
accuracy ±10 %											
Time delay (ms)	tsd	Non-adjustable									
	Non-tripping time	20									
	Maximum break time	80									

I Instantaneous protection					
Pick-up (A)	Ii non-adjustable	1500	1600	2880	4800
accuracy ±15 %	Non-tripping time	10 ms			
	Maximum break time	50 ms			

R Earth leakage protection											
Sensitivity (A)	Type A, adjustable (9 positions)										
In = 100 A	IΔn =	0.03	0.03	0.1	0.3	0.5	1	3	5	OFF	
In = 160 A	IΔn =	0.03	0.03	0.1	0.3	0.5	1	3	5	OFF	
In = 240 A	IΔn =	0.03	0.03	0.1	0.3	0.5	1	3	5	OFF	
In = 400 A	IΔn =	0.3	0.3	0.5	1	3	5	10	10	OFF	
Time delay Δt (ms)	Adjustable	Δt =	0	60 [2]	150 [2]	500 [2]	1000 [2]				
	Maximum break time (ms)	<40	<140	<300	<800	<1500					

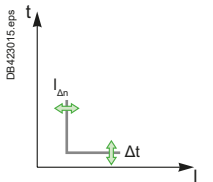

[1] For the use in high temperature environment, take into account the thermal limitation of the breaker.

[2] The time delay (Δt) is mandatory and designed "Δt = 0" when the IΔn dial is set on 30mA (0.03). The time delay has no effect when the dial IΔn is set to the "OFF" position.

ComPacT NSX Special Applications

Generator Protection with MicroLogic 2.2 G

MicroLogic G trip units are used for the protection of systems supplied by generators or comprising long cable lengths. They can be mounted on all ComPacT NSX100/160/250 circuit breakers. With extensive setting possibilities, MicroLogic 5 offers the same functions from 100 to 630 A. A thermal-magnetic trip unit is also available for the NSX100 to 250 (see page B-6).

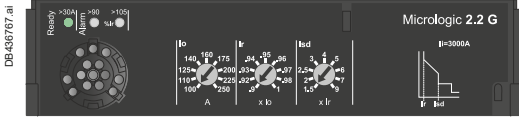

Circuit breakers equipped with MicroLogic G trip units help protect systems supplied by generators (lower short-circuit currents than with transformers) and distribution systems with long cable lengths (fault currents limited by the resistance of the cable).

Protection

Settings are made using the adjustment dials with fine adjustment possibilities.

Overloads: Long-time protection (Ir)

Inverse-time thermal protection against overloads with an adjustable current pick-up Ir and a very short, non-adjustable time delay tr (15 seconds for 1.5 x Ir).

Short-circuits: Short-time protection (Ird) with fixed time delay

Short-circuit protection with an adjustable pick-up Ird, delayed 200 ms, in compliance with the requirements of marine classification companies.

Short-circuits: Non-adjustable instantaneous protection (Ii)

Instantaneous short-circuit protection with a fixed pick-up required for generator protection.

Neutral protection

- On 3-pole circuit breakers, neutral protection is not possible.
- On four-pole circuit breakers, neutral protection may be set using a three-position switch:
 - 4P 3D: neutral unprotected
 - 4P 3D + N/2: neutral protection at half the value of the phase pick-up, i.e. 0.5 x Ir
 - 4P 4D: neutral fully protected at Ir.

Indications

Front indications

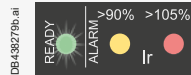

- Green "Ready" LED: the MicroLogic current transformer is continuously monitored by automatic tests. The MicroLogic will trip if the current transformer malfunctions. The blinking green "Ready" LED indicates that protection links—from CTs to electronics to the minitop release—are fully operational with no test kit required. This feature works from 15 to 50 A, depending on the device. For lower loads, a pocket battery can be used to activate the indication.
- Orange overload pre-alarm LED: steady on when I > 90 % Ir.
- Red overload LED: steady on when I > 105 % Ir.

Remote indications

An SDx relay module installed inside the circuit breaker can be used to remote the overload-trip signal. This module receives the signal from the MicroLogic electronic trip unit via an optical link and makes it available on the terminal block. The signal is cleared when the circuit breaker is closed. The module is described in detail in the section dealing with accessories.



SDx remote indication relay module with its terminal block



ComPacT NSX Special Applications

Generator Protection with MicroLogic 2.2 G

MicroLogic 2.2 G

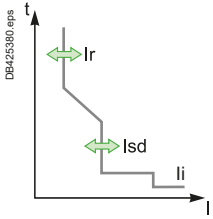

Ratings (A)	In at 40 °C [1]	40	100	160	250
Circuit breaker	ComPacT NSX100	<input checked="" type="radio"/>	<input checked="" type="radio"/>	-	-
	ComPacT NSX160	<input checked="" type="radio"/>	<input checked="" type="radio"/>	<input checked="" type="radio"/>	-
	ComPacT NSX250	<input checked="" type="radio"/>	<input checked="" type="radio"/>	<input checked="" type="radio"/>	<input checked="" type="radio"/>

L Long-time protection

Pick-up (A) tripping between 1.05 and 1.20 Ir	Io	Value depending on trip unit rating (In) and setting on dial									
In = 40 A	Io =	18	18	20	23	25	28	32	36	40	
In = 100 A	Io =	40	45	50	55	63	70	80	90	100	
In = 160 A	Io =	63	70	80	90	100	110	125	150	160	
In = 250 A (NSX250)	Io =	100	110	125	140	150	176	200	225	250	
	Ir = Io x ...	9 fine-adjustment settings from 0.9 to 1 for each Io value									

Time delay (s) accuracy 0 to -20 %	tr	Non-adjustable									
	1.5 x Ir	15									
	6 x Ir	0.5									
	7.2 x Ir	0.35									

Thermal memory 20 minutes before and after tripping

S0 Short-time protection with fixed time delay

Pick-up (A) accuracy ±10 %	Isd = Ir x ...	1.5	2	2.5	3	4	5	6	7	8	9
Time delay (ms)	tsd	Non-adjustable									
	Non-tripping time	140									
	Maximum break time	200									

I Non-adjustable instantaneous protection

Pick-up (A) accuracy ±15 %	li non-adjustable	600	1500	2400	3000
	Non-tripping time	15 ms			
	Maximum break time	50 ms			

[1] If the trip units are used in high-temperature environments, the MicroLogic setting must take into account the thermal limitations of the circuit breaker. See the temperature derating table.

B

ComPacT NSX Special Applications

Protection of Industrial Control Panels

ComPacT NSX circuit breakers are also used in industrial control panels.

They serve as incoming devices or can be combined with contactors to protect motor feeders:

- Compliance with worldwide standards including IEC 60947-2 and UL 60947-4-1/CSA C22.2 no. 60947-4-1
- Overload and short-circuit protection
- Isolation with positive contact indication, making it possible to isolate machines from all power sources
- Installation in universal and functional type enclosures
- NA switch-disconnector version.

Industrial Control Panels

ComPacT NSX circuit breakers equipped for public distribution or motor protection functions as described in the previous pages can be used in industrial control panels. The accessories for the ComPacT NSX range are suitable for the special needs of these switchboards.

Auxiliaries

All auxiliaries can be added to the circuit breaker by the user:

- Padlocking devices (in the OFF position)
- Rotary handle
- Status-indication auxiliary contacts (ON, OFF and tripped)
- Shunt (MX) or undervoltage (MN) releases
- Early-make or early-break contacts.

Rotary handle

Direct or extended versions for mounting up to 600 mm behind the front:

- Black front with black handle
- Yellow front with red handle (for machine tools or emergency off as per IEC 60204).

All rotary handles can be padlocked in the OFF position. Optional door interlock, recommended for MCC panels (motor control centres).

When the device is equipped with an extended rotary handle, a control accessory mounted on the shaft makes it possible to operate the device with the door open.

The device can be padlocked in the OFF position in compliance with UL 60947-4-1.

Early-make or early-break contacts

These contacts can be used respectively to supply an MN undervoltage release before the circuit breaker closes or to open the contactor control circuit before the circuit breaker opens.

Special functions

- Indication of thermal overloads with the SDx module.
- Early opening of the contactor for overload faults with the SDTAM module.
- Links with PLCs via the communication system.
- Measurement of all electrical parameters with MicroLogic E.
- Programmable alarms with MicroLogic 5 and 6.

Installation in Enclosures

ComPacT circuit breakers can be installed in a metal enclosure together with other devices (contactors, motor-protection circuit breakers, LEDs, etc.).

DB438641.ai

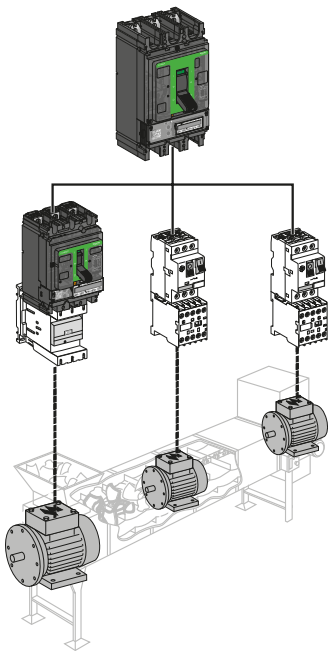

DB115234.eps



ComPacT NSX Special Applications

Protection of Industrial Control Panels

Compliance with North American Industrial Control Equipment Standards

ComPacT NSX devices have received UL 60947-4-1/CSA C22.2 no. 60947-4-1 approval for industrial control equipment of the "Manual Motor Controller", "Across the Line Starter", "General Use" and "Disconnecting Means" types.

Type NA devices are switch-disconnectors that must always be protected upstream.

UL 60947-4-1 approval

Circuit breakers	Trip units	Approvals
ComPacT NSX100 to 630 F/N/H	TMD, MicroLogic 2, 5 and 6	General Use Motor Disconnecting Means
	NA, MA, MicroLogic 1.3 M, 2.2 M, 2.3 M, MicroLogic 6.2 E-M and 6.3 E-M	Manual Motor Controller Across the Line Starter Motor Disconnecting Means

Table of 3-phase motor ratings in hp (1 hp = 0.7457 kW)

V AC ratings		115	230	460	575
TMD MicroLogic 2, 5 and 6	NA, MA MicroLogic 1.3 M, 2.2 M, 2.3 M MicroLogic 6.2 E-M and 6.3 E-M				
25	25	3	7.5	15	20
50	50	7.5	15	30	40
100	100	15	30	75	100
160	150	25	50	100	150
250	220	40	75	150	200
400	320	-	125	250	300
550	500	-	150	350	500

The deratings indicated on [pages E-13 to E-16](#) apply to TMD, MicroLogic 2, 5 and 6 trip units, rated at 40 °C



ComPacT NSX Special Applications

16 Hz 2/3 Network Protection - MicroLogic 5 A-Z Trip Unit

ComPacT NSX circuit breakers may be used on 16 Hz 2/3 systems with special thermal-magnetic and electronic (MicroLogic 5 A-Z) trip units.

16 Hz 2/3 Networks

Single-phase distribution networks with a frequency of 16 Hz 2/3 are used for railroad applications in certain European countries.

Breaking Capacity for 16 Hz 2/3 at 250/500 V

ComPacT NSX circuit breakers of the 3P 3D type protect 16 Hz 2/3 networks at 250 V or 500 V.

They can be equipped with either:

- A TM-D thermal-magnetic trip unit for ComPacT NSX100 to 250
- Or an electronic MicroLogic 5.2 A-Z trip unit for ComPacT NSX100 to 250 or a 5.3 A-Z for ComPacT NSX400/630.

The possible breaking-capacity performance levels are B, F, N and H as indicated below.

Breaking capacity Icu

Operating voltage	Performance	TMD and MicroLogic 5 A-Z trip units			
		B	F	N	H
250 V/500 V	Icu (kA)	25	36	50	70

Protection

TM-D Thermal-Magnetic Trip Units

The 16 Hz 2/3 frequency does not modify the thermal settings with respect to those at 50 Hz (see page B-6). The magnetic pick-ups are modified as shown below.

Magnetic protection for ComPacT NSX 100/160/250 at 50 Hz and at 16 Hz 2/3

Rating (A) In at 40 °C		16	25	32	40	50	63	80	100	125	160	200	250	
Pick-up (A) Ii accur. ±20%	Fixed												Adjustable	
NSX100	50Hz	190	300	400	500	500	500	640	800					
	16Hz 2/3	170	270	360	450	450	450	580	720					
NSX160/250	50Hz	190	300	400	500	500	500	640	800	1250	1250	5 to 10 In		
	16 Hz 2/3	170	270	360	450	450	450	580	720	1100	1100	4.5 to 9 In		

MicroLogic 5 A-Z Trip Units

MicroLogic 5.2 A-Z and 5.3 A-Z are dedicated to 16 Hz 2/3 networks.

They use a suitable sampling frequency. The protection settings are identical to those of MicroLogic 5 A (see page B-12). They also offer a current-measurement function for this specific frequency.

Trip-Unit Selection

Rating	16	63	100	160	250	400	630
ComPacT							
NSX100	TM-D						
NSX160		TM-D					
NSX250				TM-D			
NSX100 to 250			MicroLogic 5.2 A-Z				
NSX400/630						MicroLogic 5.3 A-Z	

Wiring for NSX100 to 630 A

Phase and isolated neutral interrupted- 250/500 V

N and H (3P 3D version)

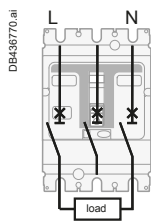

2 poles in series - Earthed neutral 250/500 V

N and H (3P 3D version)

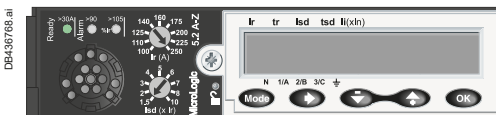
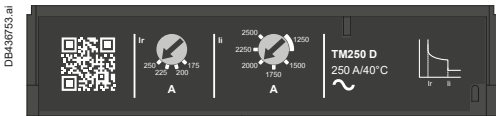
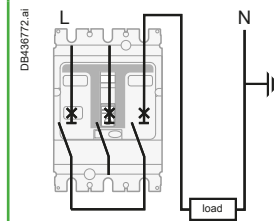

ComPacT NSXm Special Applications

Protection of 400 Hz Systems

ComPacT NSXm circuit breakers may be used on 400 Hz systems.

Breaking Capacity in 400 Hz, 440 V Systems

The power levels of 400 Hz applications rarely exceed a few hundred kW with relatively low short circuit current, generally not exceeding four times the rated current.

Circuit breaker	Max. Breaking Capacity at 400 Hz
NSXm	10 kA

Thermal-Magnetic Trip Units

Thermal-Magnetic trip units require the current rating (I_n) to be derated and the magnetic trip setting (I_i) to be increased.

Current Rating (I_n) and Magnetic Trip Setting (I_i) Rerating

Circuit breaker	Maximum setting Coefficient	Max I_r setting at 400 Hz	Magnetic I_i coefficient at 400 Hz
NSXm	0.9	144	1.6

Shunt Trip (MX) or Undervoltage Trip (MN) Voltage Release at 400 Hz and 440 V

Undervoltage releases (MN) rated 24 V AC/DC, 48 V AC/DC, or 110/130 V AC/DC are 400 Hz compliant with their nominal voltages. For voltages greater than 110/130 V AC/DC, please contact Schneider Electric for additional information. Shunt Trips (MX), please contact Schneider Electric.



ComPacT NSXm TM-D

C12H3TM160L.eps

B

ComPacT NSX Special Applications

Protection of 400 Hz Systems

ComPacT NSX circuit breakers may be used on 400 Hz systems.

400 Hz Distribution Systems

The main 400 Hz applications are in aeronautics and certain military ships. Modern aircraft have three-phase 115/200 V 400 Hz networks.

Impact on Protective Devices

Due to the higher frequency, circuit breakers are subjected to additional temperature rise for identical current levels, resulting from higher losses caused by Foucault currents and an increase in the skin effect (reduction in the useful CSA of conductors). To remain within the rated temperature-rise limits of devices, current derating is required.

The power levels of 400 Hz applications rarely exceed a few hundred kW with relatively low short-circuit currents, generally not exceeding four times the rated current.

The standard ComPacT NSX range is suitable for 400 Hz applications if derating coefficients are applied to the protection settings. See the derating table below.

Breaking Capacity of ComPacT NSX Circuit Breakers in 400 Hz, 440 V Systems

Circuit breaker	Breaking capacity I _{cu}
NSX100	10 kA
NSX160	10 kA
NSX250	10 kA
NSX400	10 kA
NSX630	10 kA

Trip Units Equipped with Thermal-Magnetic Protection

The 400 Hz current settings are obtained by multiplying the 50 Hz values by the following adaptation coefficient:

- K1 for thermal trip units
- K2 for magnetic trip units.

These coefficients are independent of the trip-unit setting.

Thermal trip units

The current settings are lower at 400 Hz than at 50 Hz ($K1 < 1$).

Magnetic trip units

The current settings are conversely higher at 400 Hz than at 50 Hz ($K2 > 1$).

Consequently, when the trip units are adjustable, they must be set to the minimum value.

Adaptation coefficients for thermal-magnetic trip units

Circuit breaker	Trip unit	I _n (A) 50Hz	Thermal at 40°C		I _i (A) 50Hz	Magnetic	
			K1	400 Hz		K2	400 Hz
NSX100	TM16G	16	0.95	15	63	1.6	100
	TM25G	25	0.95	24	80	1.6	130
	TM40G	40	0.95	38	80	1.6	130
	TM63G	63	0.95	60	125	1.6	200
NSX100	TM16D	16	0.95	15	240	1.6	300
	TM25D	25	0.95	24	300	1.6	480
	TM40D	40	0.95	38	500	1.6	800
	TM63D	63	0.95	60	500	1.6	800
	TM80D	80	0.9	72	650	1.6	1040
	TM100D	100	0.9	90	800	1.6	1280
	NSX160	TM80D	80	0.9	72	650	1.6
NSX160	TM100D	100	0.9	90	800	1.6	1280
	TM125D	125	0.9	112.5	1250	1.6	2000
	TM160D	160	0.9	144	1250	1.6	2000
	NSX250	TM100D	100	0.9	90	800	1.6
NSX250	TM160D	160	0.9	144	1250	1.6	2000
	TM200D	200	0.9	180	1000 to 2000	1.6	1600 to 3200
	TM250D	250	0.9	225	1250 to 2500	1.6	2000 to 4000

Example

NSX100 equipped with a TM16G with 50 Hz settings I_r = 16 A and I_i = 63 A. 400 Hz settings I_r = 16 x 0.95 = 15 A and I_i = 63 A x 1.6 = 100 A.

C2532D350.eps



MicroLogic TM-D trip unit

B

ComPacT NSX Special Applications

Protection of 400 Hz Systems

Protection

MicroLogic Electronic Trip Units

MicroLogic 2.2, 2.3 or 5.2, 5.3 with E measurement functions are suitable for 400 Hz. The use of electronics offers the advantage of greater operating stability when the frequency varies. However the units are still subject to temperature rise caused by the frequency.

The practical consequences are:

- Limit settings: see the I_r derating table below.
- The long-time, short-time and instantaneous pick-ups are not modified (see page B-10 or page B-12).
- The accuracy of the displayed measurements is 2 % (class II).

Thermal derating: maximum I_r setting

Circuit breaker	Maximum setting coefficient	Max. I _r setting at 400 Hz
NSX100	1	100
NSX250	0.9	225
NSX400	0.8	320
NSX630	0.63	400

Example

An NSX250N, equipped with a MicroLogic 2.2, I_r = 250 A at 50 Hz, must be limited to use at I_r = 250 x 0.9 = 225 A.

Its short-time pick-up with fixed time delay is adjustable from 1.5 to 10 I_r (337.5 to 2250 A).

The instantaneous pick-up remains at 3000 A.

OF Auxiliary Contacts in 400 Hz Networks

Electrical characteristics of auxiliary contacts

Contacts	Standard		Low level	
	AC12	AC15	AC12	AC15
Utilization cat. (IEC 60947-5-1)	AC12	AC15	AC12	AC15
Operational current I _c (A)	6	6	5	3
48 V	6	6	5	3
110 V	6	5	5	2.5
220/240 V	6	4	5	2
380/415 V	6	2	5	1.5

MN and MX Voltage Releases for ComPacT NSX100/630 at 400 Hz and 440 V

For circuit breakers on 400 Hz systems, only 125 V DC MN or MX releases may be used. The release must be supplied by the 400 Hz system via a rectifier bridge (to be selected from the table below) and an additional resistor with characteristics depending on the system voltage.

U (V) 400 Hz	Rectifier	Additional resistor
220/240 V	Thomson 110 BHz or General Instrument W06 or Semikron SKB at 1.2/1.3	4.2 kΩ-5 W
380/420 V	Semikron SKB at 1.2/1.3	10.7 kΩ-10 W

Note: Other models of rectifier bridges may be used if their characteristics are at least equivalent to those stated above.

SDx Indication Contacts

The SDx module may be used in 400 Hz systems for voltages from 24 to 440 V.

An SDx relay module installed inside the circuit breaker can be used to remote the overload-trip signal.

This module receives the signal from the MicroLogic electronic trip unit via an optical link and makes it available on the terminal block. The signal is cleared when the circuit breaker is closed.

These outputs can be reprogrammed to be assigned to other types of tripping or alarm (see page C-35).

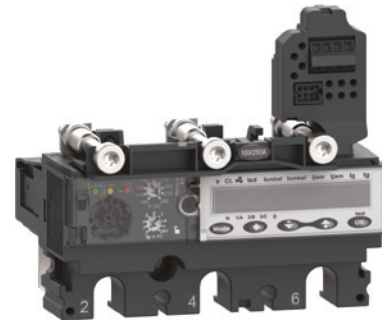

MicroLogic 5 E trip unit

C2538E260.eps



Indication contacts

29450.eps



MX or MN voltage release

PB120468.eps

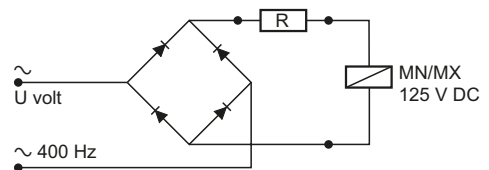

Wiring diagram

DB116579.eps



SDx remote indication relay module with its terminal block

PB103377.eps

B

ComPacT NSX Special Applications

ComPacT NSX400K at 1000 V AC

The ComPacT NSX range includes the NSX400K 3P and 4P at 800 VAC and 1000 VAC models, with adjustable electronic trip unit Micrologic 2.3 rating 250A and 400A.

The ComPacT NSX400K offers the following features of the ComPacT NSX range:

- Compliance with most standards
- Ultimate breaking capacity of 10 kA at 1000 VAC and 36 kA at 800 VAC
- Suitable for isolation with positive break indication
- Accessories: MN-MX and OF-SD auxiliaries, motor mechanism, rotary handles, locking kit and terminal shields.

PB124122.eps



DB438281.ai

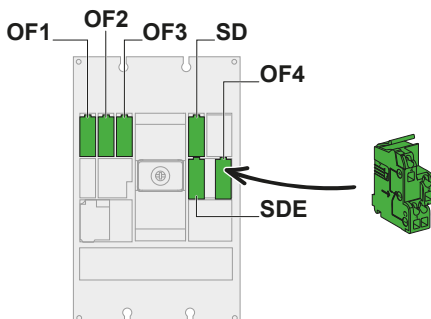

> Substitution and Technical Guide
ComPacT NSX High Performance



LVPED221004EN

Compliance with Standards

- International: IEC 60947-2
- EN 60947-2

Suitability for Isolation and People Safety

All Compact circuit-breakers are suitable for isolation as defined in IEC standard 60947-2. The operating handle cannot indicate the "off" position unless the contacts are actually open. Fitting a rotary handle or a motor mechanism does not alter the reliability of the position indication system.

For protection against direct contact with live parts, Compact circuit breakers may be installed through the door of Class II switchboards (as per IEC 60664).

Electrical characteristics

Number of poles	3 & 4		
IEC/EN 60947-2			
Rated insulation voltage	Ui (V AC)	1000	
Rated impulse withstand voltage	Uimp (kV)	8	
Rated operational voltage	Ue (V)	AC 50/60 Hz	1000
Ultimate breaking capacity	Icu (kA rms)	AC 1000 V	10
		AC 800 V	36
Service breaking capacity	Ics (kA rms)	AC 1000 V	10
		AC 800 V	10
Suitability for isolation	■		
Utilization category	A		
Pollution degree	3		

Electronic trip unit

Factory mounted	Refer to Micrologic 2.3 section for trip settings
-----------------	---

Auxiliaries for Indication, Measurement and Control

- Direct or extended rotary handles
- Padlocking and keylocking devices
- Motor mechanism featuring short closing time
- Status indication auxiliary contacts (contact positions, tripped, electrical fault, earth fault)
- Shunt and undervoltage auxiliary releases

B

ComPacT NSX Special Applications

ComPacT NSX400K at 1000 V AC

Safety Parameters

Fixed front connection.

Supply by the top only. Connection by cables or busbars.

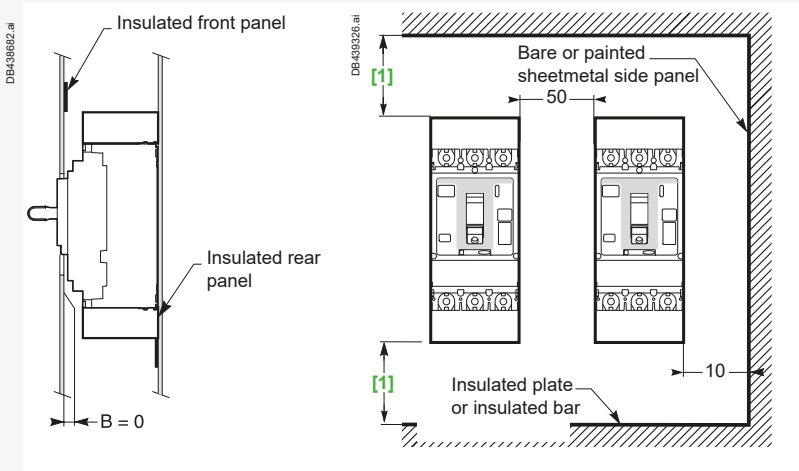

[1] 50 mm with short terminal shield
30 mm with long terminal shield.

Note: Long or short terminal shield are mandatory.

B

B

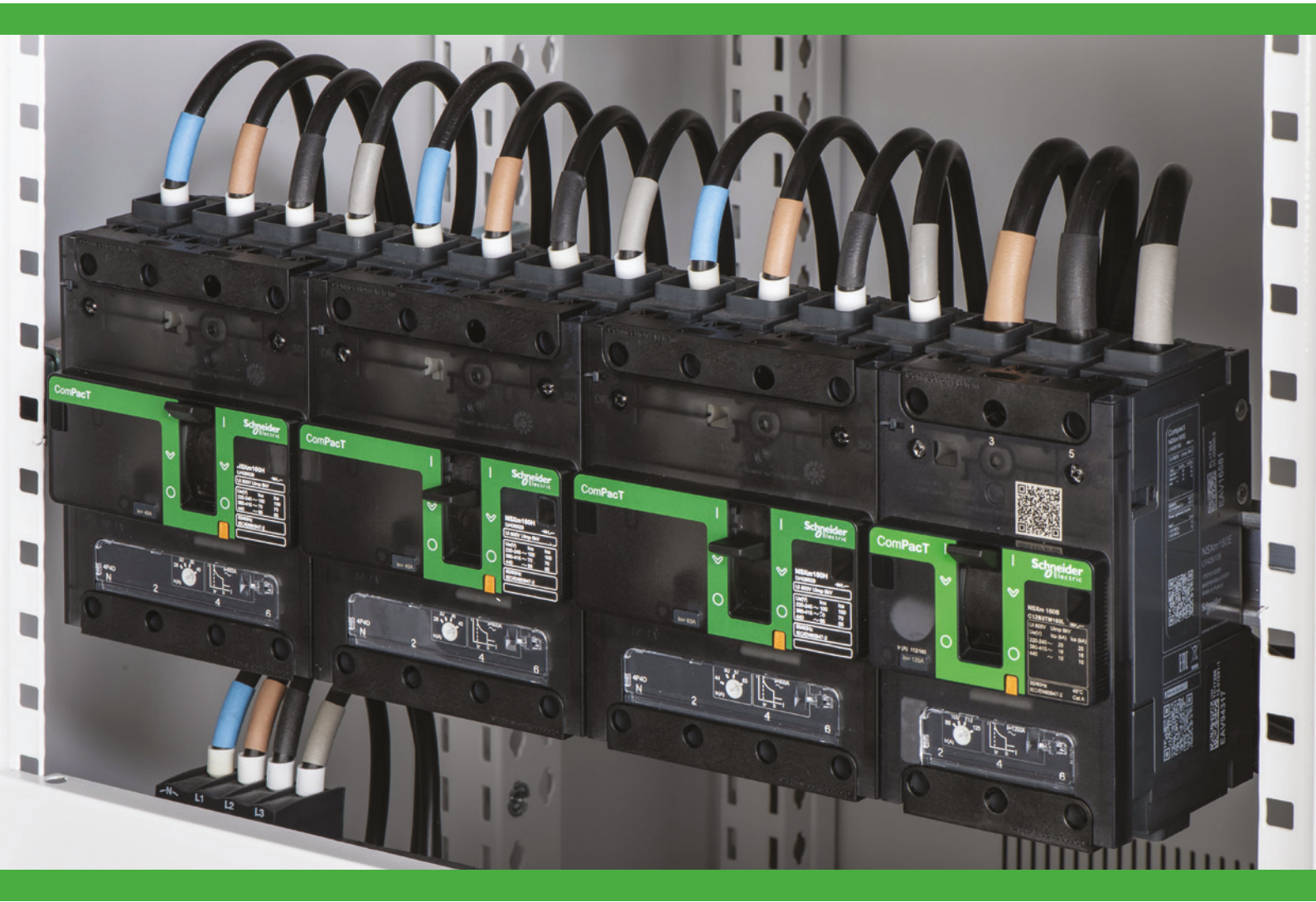

Customize Circuit Breaker with Accessories

ComPacT NSXm Accessories and Auxiliaries

Overview	C-2
Power Connection of Fixed Devices	C-4
Insulation of Live Parts.....	C-6
Selection of Auxiliaries.....	C-7
Connection of Auxiliaries.....	C-8
Indication Contacts.....	C-9
Voltage Release	C-10
SDx Module for MicroLogic Vigi 4.1	C-11
Rotary Handles	C-12
Locks and Sealing Accessories	C-14

ComPacT NSX Accessories and Auxiliaries

Overview Fixed Version	C-16
Overview Plug-in and Withdrawable Versions	C-17
Device Installation	C-18
Connection of Fixed Devices	C-20
Connection of Withdrawable and Plug-in Devices	C-24
Insulation of Live Parts.....	C-25
Selection of Auxiliaries for NSX100/160/250	C-26
Selection of Auxiliaries for NSX400/630	C-29
Connection of Electrical Auxiliaries	C-32
Indication Contacts.....	C-34
SDx and SDTAM	C-35
Motor Mechanism	C-36
Remote Tripping.....	C-37
Rotary Handles	C-38
Manual and Automatic Transfer Switch	C-40
Mechanical Interlocking.....	C-41
Mechanical and Electrical Interlocking for Source-Changeover Systems.....	C-42
Automatic Source-Changeover Systems with Controller	C-43
Additional Measurement Module: PowerLogic PowerTag Monoconnect 250 A and 630 A for NSX	C-45

ComPacT NSXm Accessories and Auxiliaries

Additional Measurement Module: PowerLogic PowerTag Flex 160 A for NSXm.....	C-48
--	------

ComPacT NSX Accessories and Auxiliaries

Additional Measurement and Indication Modules	C-50
Locks.....	C-51
Sealing Accessories	C-52
Escutcheons and Protection Collars	C-53

Other Chapters

Select Circuit Breakers and Switch-Disconnectors	A-1
Select Protection	B-1
Smart Panel Integration	D-1
Switchboard Integration.....	E-1
Catalog Numbers	F-1
Glossary	G-1
Additional Characteristics.....	H-1



ComPacT NSXm Accessories and Auxiliaries

Overview

DB438615.ai

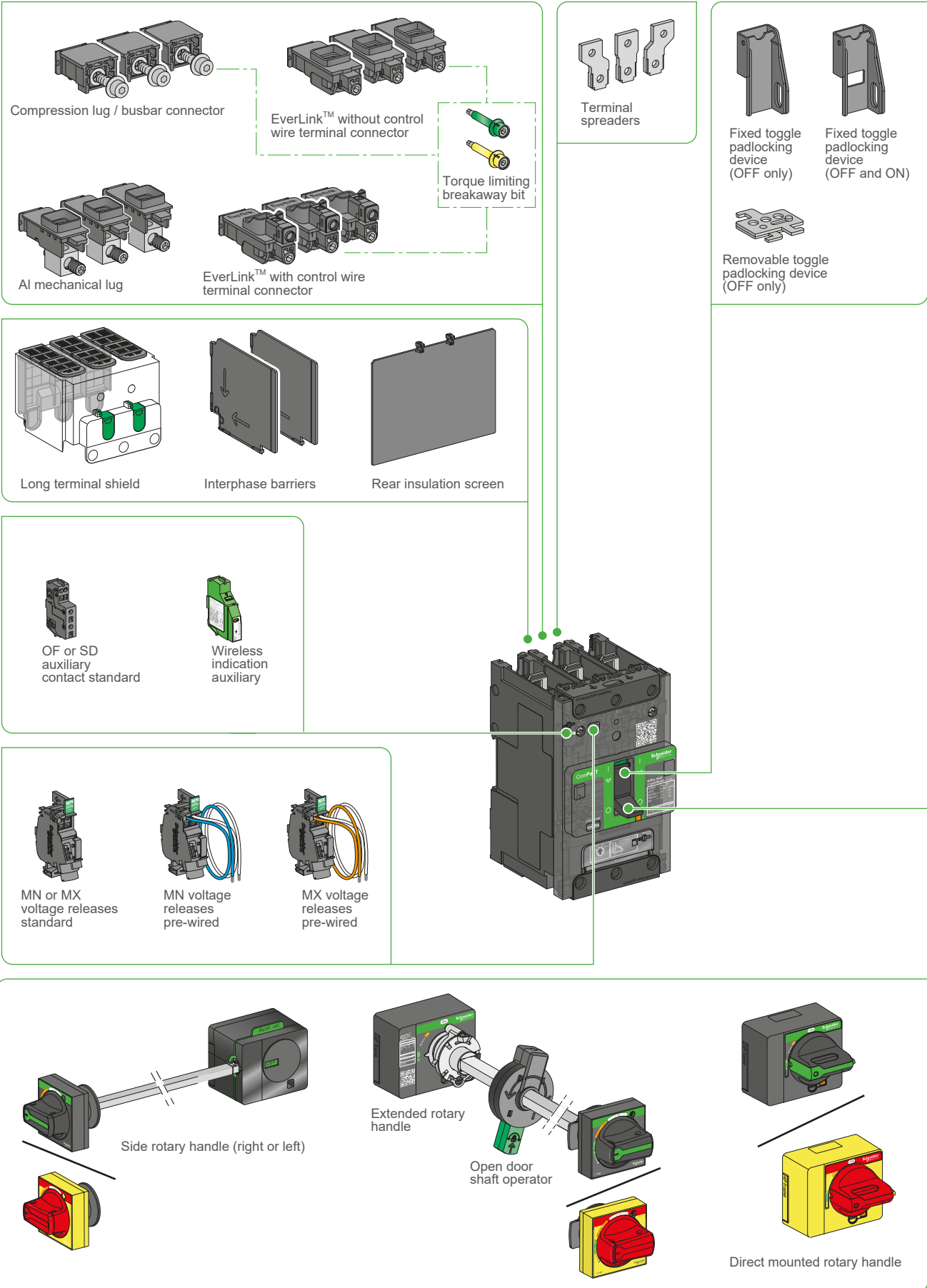

Customize Circuit Breakers with Accessories ComPacT NSXm Accessories and Auxiliaries

Overview

DB430616.pl

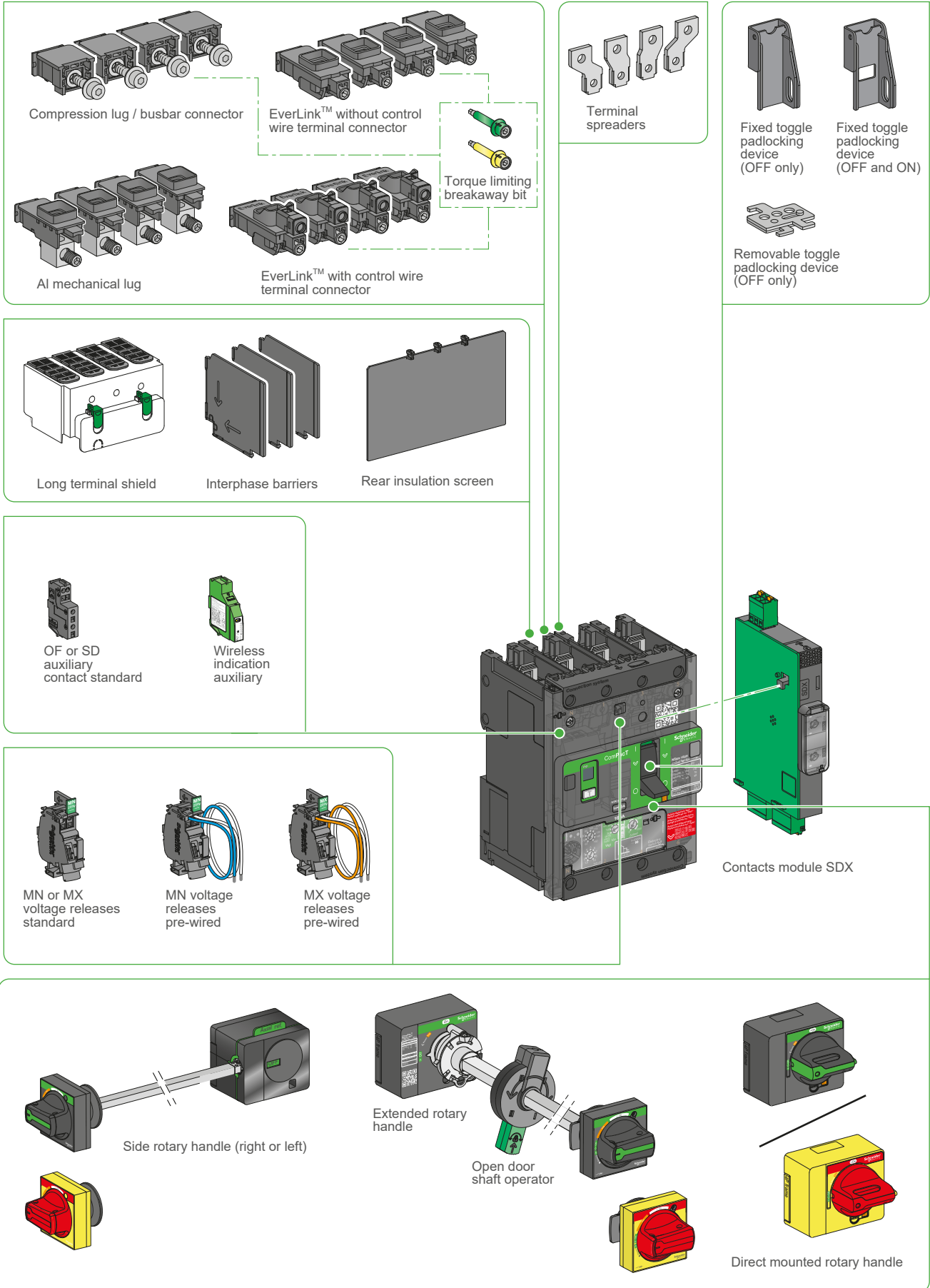

ComPacT NSXm Accessories and Auxiliaries

Power Connection of Fixed Devices



Fixed circuit breakers are designed for standard front connection using cables. Bars or cables with lugs connectors are also available.

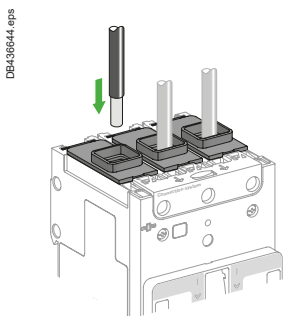
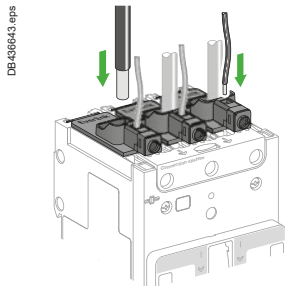
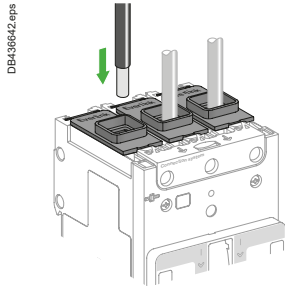

Power Connection

Circuit breakers are delivered with EverLink™ lug connectors for bare cables. They may be delivered with connectors for bars or cables with compression lugs. The connectors can be removed for the installation of one of the 4 kinds of connectors available (EverLink™ lug with control wire terminal, EverLink™ lug, compression lugs/busbar, aluminium mechanical lug). For connection of large cables, a number of solutions with spreaders may be used for both cables with lugs or bars.

Bare Cables

Standard terminal: EverLink™ lug connector

This type of connection uses the EverLink™ system with creep [1] compensation (Schneider Electric patent).

This technique makes it possible to achieve accurate and durable tightening torque, in order to avoid cable creep.

When ordered as spare part, EverLink™ connectors have control wire terminal in order to make some measurement connection (limited to 10 A).

EverLink™ lugs for use with Al or Cu wire

Wire range

Solid/stranded	Flexible	Torque
Power connection 15-160 A (Cu), 15-100 A (Al)		
2.5 - 10 mm ²	2.5 - 10 mm ²	5 N.m ±0.5
16 - 95 mm ²	16 - 70 mm ²	9 N.m ±0.9
Control wire terminal up to 10 A (Cu)		
1.5 - 6 mm ²	0.5 - 6 mm ²	1 N.m ±0.1

Aluminium mechanical connectors up to 125 A

The standard EverLink lugs can be removed for the installation of mechanical lugs. Lugs suitable for copper and aluminum conductors are made of tin-plated aluminum. The mechanical lugs are fastened to the terminals with lug mounting screws, inserted from the bottom of the circuit breaker. The lug cover is held in place with built-in snap features. They are sold as field installable kits.

Aluminium mechanical connectors up to 125 A

Power connection

Ampere rating	Wire range	
	Solid/stranded	Torque
15-125 A (Cu)	2.5 - 6 mm ²	4 N.m ±0.4
15-125 A (Al)	10 - 70 mm ²	5.6 N.m ±0.6

[1] Creep: normal crushing phenomenon of conductors, that is accentuated over time.



ComPacT NSXm Accessories and Auxiliaries

Power Connection of Fixed Devices

Bars or Cables with Lugs

Compression lug/busbar connectors

The ComPacT NSXm circuit breakers may be equipped with captive nuts and M6 screws connectors. These are readily field-installable, simply by removing the EverLink lug and replacing with the appropriate terminal nut.

They are also available factory installed. These terminals may be used for:

- Direct connection of insulated bars or cables with compression (crimp) lugs.
- Terminal extensions offering a wide range of connection possibilities.

Compression lug/busbar connectors, 15-160 A

Power Connection	Torque
≤ 10 mm ²	5 N.m ±0.5
≥ 16 mm ²	9 N.m ±0.9

Interphase barriers or terminal shields are recommended. They are mandatory for certain connection accessories (in which case the interphase barriers are provided).

Crimp lugs large size cables

There are two models, for aluminium and for copper cables. It is necessary to use narrow lugs, compatible with device connections. They must be used with interphase barriers or long terminal shields.

The lugs are supplied with interphase barriers and may be used for the types of cables listed below.

Crimp lugs for use with ComPacT NSXm

Copper cables	size	rigid	70 mm ²	95 mm ²	120 mm ²
		flexible	50 mm ²	70 mm ²	95 mm ²
	crimping	hexagonal barrels or punching			
Aluminium cables	size	rigid		95 mm ²	120 mm ²
	crimping	hexagonal barrels			

Bars

When the switchboard configuration has not been tested, insulated bars are mandatory.

Bar and lugs dimensions

Dimensions	A	B	C	D	E
mm	6.4	≤ 8	≤ 20	7	≥ 17

Spreaders

Spreaders may be used to increase the pitch from 27 mm to 35 mm. Bars or cable lugs can be attached to the ends.

They are provided with M8 screws for power connection and interphase barriers (not compatible with long terminal shield). Rear insulation screens may have to be used too depending on the distance between the live uninsulated parts and the grounded metallic back pan.

Torque Limiting Breakaway Bits

Torque limiting breakaway bits may be used, particularly in the field, to tighten at the right torque EverLink™, compression lug or busbar power connections.

Throwaway tips

Circuit breaker application			Qty per kit
Ampere rating	Torque		
16-160 A	5 N.m		6 or 8
16-160 A	9 N.m		6 or 8

DB436645.eps

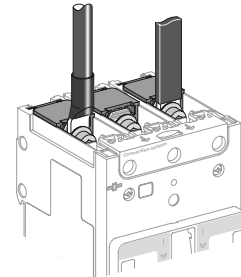

DB418860.eps

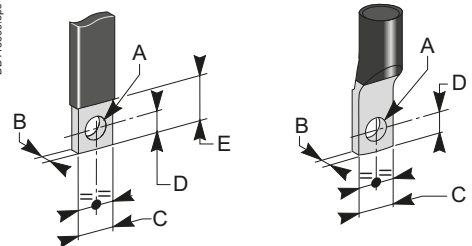

DB436646.eps

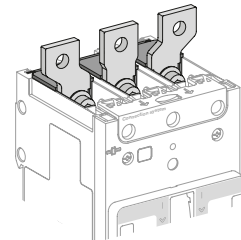

DB438647.eps

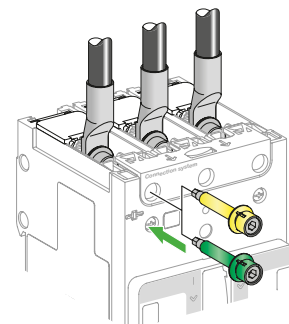

ComPacT NSXm Accessories and Auxiliaries

Insulation of Live Parts

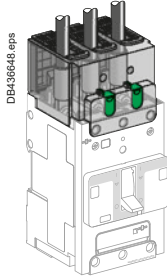

Long terminal shields

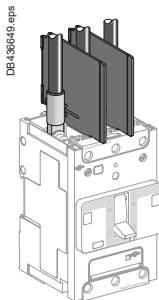

Interphase barriers

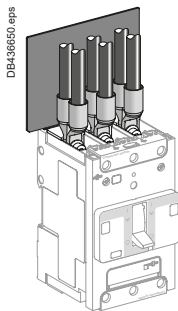

Rear insulating screens

Long Terminal Shields IP40

ComPacT NSXm 3P or 4P can be equipped with long terminal shields. They can be mounted upstream and downstream and are used for protection against direct contact with power circuits. They provide IP40 degree of protection and IK07 mechanical impact protection. Moreover long terminal shields can be mounted after product installation on plate or DIN rail, and can be removed and put in place even if there are auxiliary wires.

They are used for connection with cables or insulated bars.

They are comprised of two parts assembled with 2 locks and/or captive screws, forming an IP40 cover.

- The top part is transparent in order to be able to see the connection through it and is equipped with sliding grids with break marks for precise adaptation to cables or insulated bars.
- The rear part completely blocks off the connection zone. Partially cut squares can be removed to adapt to all types of connection for cables with lugs or copper bars.

Interphase Barriers

Accessories for maximum insulation at the power-connection points:

- They clip easily onto the circuit breaker
- Not compatible with long terminal shield
- 2 ways mounting: short/long insulation.

Rear Insulating Screens

Accessories providing insulation at the rear of the device.

Their use may be mandatory if no long terminal shield depending of the distance between bare conductors and backplate.

The screen dimensions are shown below.

Circuit breaker	NSXm
3P W x H x thickness (mm)	110 x 84 x 1
4P W x H x thickness (mm)	145 x 84 x 1



Customize Circuit Breakers with Accessories

ComPacT NSXm Accessories and Auxiliaries

Selection of Auxiliaries

Standard

All ComPacT NSXm circuit breakers and switch-disconnectors have slots for the electrical auxiliaries listed below:

- 2 indication contacts (see page C-9):
 - 1 ON/OFF (OF)
 - 1 trip indication (SD)
- Either 1 MN undervoltage release or 1 MX shunt trip (see page C-10).

Remote Indications

Circuit breakers with MicroLogic Vigi 4.1 may be equipped with an alarming/fault trip indication module to inform before a trip or to identify the type of fault (see page C-11).

All these auxiliaries may be installed with a rotary handle or a toggle handle.

The following drawing indicates auxiliary possibilities depending on the type of device.



Thermal Magnetic Circuit Breaker (TM-D), Switch (NA)

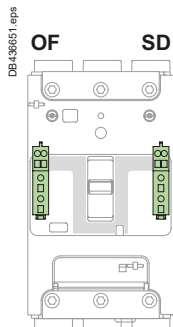

3 poles device

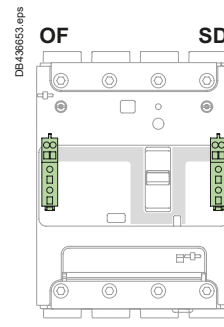
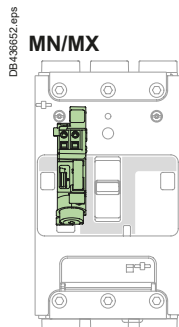

4 poles device

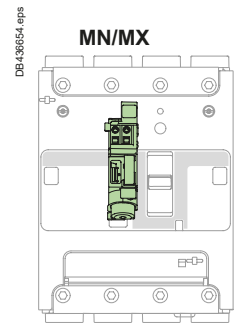

Earth Leakage Circuit Breaker (MicroLogic Vigi 4.1)

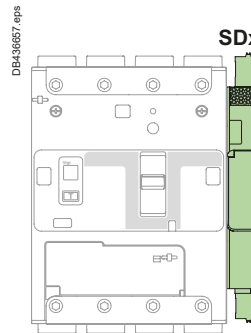
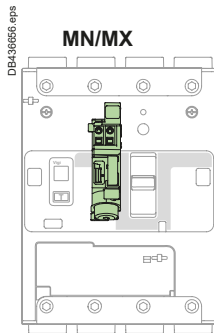
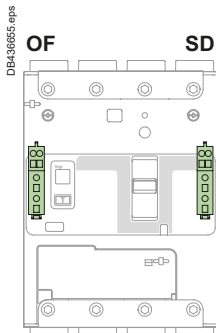

3/4 poles device in 4 poles footprint

ComPacT NSXm Accessories and Auxiliaries

Connection of Auxiliaries

Wiring

Electrical accessories are fitted with numbered spring terminal blocks for wires. The maximum wire size is 1.5 mm² for auxiliary switches (OF or SD), shunt trip MX or undervoltage release MN.

Electrical accessory wire routing can be exited out any of the four corners of the breaker, under the accessory cover even when using long terminal shield

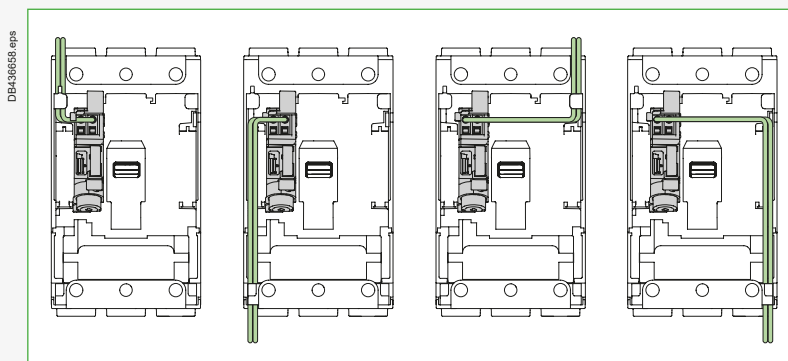

Customize Circuit Breakers with Accessories

ComPacT NSXm Accessories and Auxiliaries

Indication Contacts

Auxiliary and Alarm Indication Contacts

Indication contacts provide remote information of the circuit breaker status and can thus be used for indications, electrical locking, relays, etc. They are common point changeover type contacts, with a normally open (NO) contact and a normally closed (NC) contact. Terminals are spring type in order to ensure a fast and reliable connection.

Open/Closed - Auxiliary Switches (OF)

- Indicates the position of the circuit breaker contacts.

Trip Indication - Alarm Switch (SD)

- Indicates that the circuit breaker has tripped due to:
 - An electrical fault (overload, short circuit)
 - The operation of a shunt trip
 - Undervoltage release
 - The "push-to-trip" button
- Resets when the circuit breaker is reset.

Installation and Connection

- The auxiliary switch (OF) and alarm switch (SD) indication contacts snap into cavities behind the front accessory cover of the circuit breaker and their presence is visible on the front face through green flags.
- One model serves for all indication functions depending on where it is fitted in the circuit breaker.
- Each NO and NC spring terminal may be connected by one 0.5...1.5 mm² flexible copper wire and by two for the common point. No cable ends are to be used on the auxiliary wires connected to those terminals.

Electrical Characteristics of Auxiliary Contacts

Characteristics						
Rated thermal current (A)	5					
Minimum load	2 mA at 17 V DC					
Utilization cat. (IEC 60947-5-1)	AC12	AC15	DC12	DC13	DC14	
Operational current (A)	24 V AC/DC	5	5	5	2.5	1
	48 V AC/DC	5	5	2.5	1.2	0.2
110...127 V AC/110 V DC	220/240 V AC	5	4	0.8	0.35	0.05
	250 V DC	-	-	0.3	0.05	0.03
	380/440 V AC	5	2.5	-	-	-
	660/690 V AC	5	0.1	-	-	-

Standards

- Auxiliary indicator contacts comply with IEC 60947-5-1.
- Auxiliary contacts have also been tested according IEC 60 947-5-4.

Wireless Indication Auxiliary

The Wireless Indication Auxiliary communicates via IEEE802.15.4 to a gateway. It does not require any wiring, but does contain a battery.

ComPacT NSXm:

- Battery lifetime: 5 years



For more information on the **Wireless Indication Auxiliary**, refer to the instruction sheet **NNZ8881001**.



PB119125_L12.eps

Auxiliary Switch (OF) / Alarm Switch (SD)



PB124124.eps

Wireless Indication Auxiliary

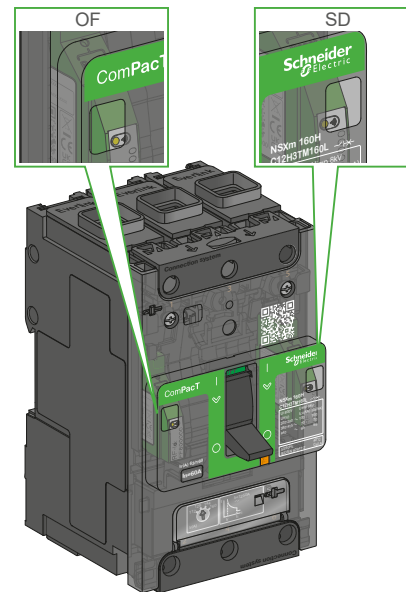

DB438222.ai



ComPacT NSXm Accessories and Auxiliaries

Voltage Release



MX or MN voltage release

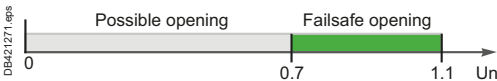

Opening conditions of the MX release

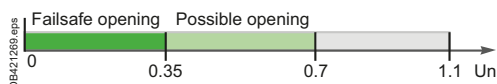

Opening conditions of the MN release



Closing conditions of the MN release

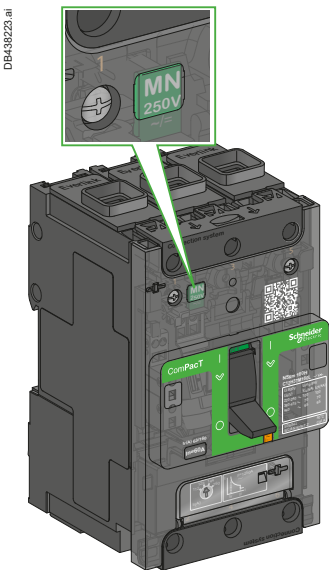

Operating voltages for MN/MX

Shunt Trip (MX) and Undervoltage Release (MN)

A voltage release can be used to trip the circuit breaker using a control signal. They serve primarily for remote, emergency-off commands. It is advised to test the system every six months.

Shunt Trip (MX)

- Trips the circuit breaker when the control voltage rises above 70 % of its rated voltage (U_n).
- Impulse type ≥ 20 ms or maintained control signals.
- Shunt trip 110...130 V AC is suitable for ground-fault protection when combined with a Class I ground-fault sensing element.
- Continuous duty rated coil [1].

Undervoltage Release (MN)

- Trips the circuit breaker when the control voltage drops below 35 % of its rated voltage.
- Between 35 % and 70 % of the rated voltage opening is possible but not ensured.
- Above 70 % of the rated voltage, opening does not take place.
- Continuous duty rated coil.
- Circuit breaker closing is possible only if the voltage exceeds 85 % of the rated voltage. If an undervoltage condition exists, operation of the closing mechanism of the circuit breaker will not permit the main contacts to touch, even momentarily. This is commonly called "Kiss Free".

Time-Delay Unit for an Undervoltage Release (MN)

- A time delay unit eliminates the risk of nuisance tripping due to a transient voltage dip lasting less than 200 ms for fixed delay units and up to 3 seconds for adjustable units. For shorter micro-outages, a system of capacitors provides temporary supply to the MN at $U > 0.7 U_n$ to ensure non tripping.

The correspondence between MN and time-delay units is shown below.

Power supply	Corresponding MN
Unit with fixed delay 200 ms	
48 V AC	48 V DC
220/240 V AC	250 V DC
Unit with adjustable delay ≥ 200 ms	
48 - 60 V AC/DC	48 V DC
100 - 130 V AC/DC	125 V DC
220 - 250 V AC/DC	250 V DC

Installation and Connection

- Accessories snap into cavities under the front accessory cover of the circuit breaker. The presence and characteristics of the voltage release is visible from the front face through a window.
- Terminals are spring type in order to ensure a fast and reliable connection.
- Each terminal may be connected by one 0.5...1.5 mm² flexible copper wire. No cable ends are to be used on the auxiliary wires connected to those terminals.

Operation

- The circuit breaker must be reset locally after being tripped by shunt trip (MX) or undervoltage release (MN).
- Tripping by the shunt trip or undervoltage release has priority over manual closing; in the presence of a standing trip order such an action does not result in any closing, even temporarily, of the main contacts.
- Endurance: 50 % of the rated mechanical endurance of the circuit breaker.

Standard

- MN/MX voltage releases comply with IEC 60947-2.

[1] Except for MX 24 V AC/DC (in case of continuous activation, may generate some minor perturbation in sensitive environment).

Customize Circuit Breakers with Accessories

ComPacT NSXm Accessories and Auxiliaries

SDx Module for MicroLogic Vigi 4.1

SDx Module for ComPacT NSXm MicroLogic Vigi 4.1

The SDx module provides alarming and fault differentiation for the ComPacT NSXm with MicroLogic Vigi 4.1.

This module has 2 NO/NC outputs dry contacts. Each can be assigned with one of the following status:

- Overload alarm (SDT105): current is higher than 105 % of the setting current (I_r).
- Overload trip indication (SDT): circuit breaker has tripped due to an overload fault.
- Earth leakage alarm (SDV80): leakage current is higher than 80 % of the earth leakage trip threshold ($I_{\Delta n}$).
- Earth leakage trip indication (SDV): circuit breaker has tripped due to an earth leakage current.

Outputs are automatically reset when the alarm disappears or when the circuit breaker is restarted.

Output Characteristics

- 2 NO/NC dry contacts
- 24...250 V AC/DC
- 2 mA...5 A max
- AC-15 (230 V max - 400 VA)
- DC-13 (24 V - 50 W)

Power Characteristics

- 24...240 V AC/DC

Front Face Indication



- Green led "On": flashes slowly when the module is powered.
- 2 red led for output status indication.
- 2 setting dials.

Installation and Connection

The SDx module is clipped on the right side on the circuit breaker. Each removable spring terminal can be connected by one 0.5... 1.5 mm² copper wire.

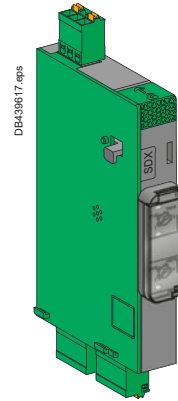

SDx relay module with its terminal block

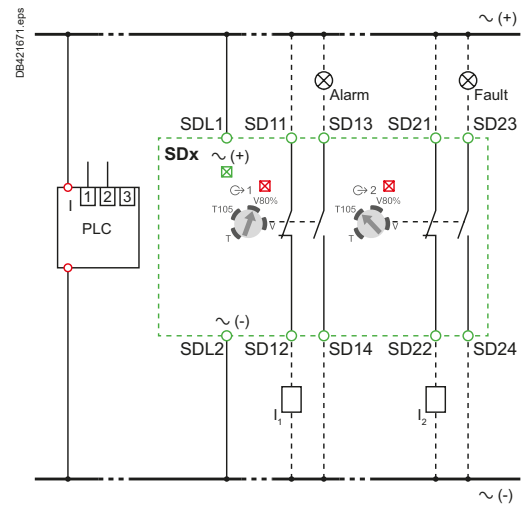

SDx wiring diagram



ComPacT NSXm Accessories and Auxiliaries

Rotary Handles

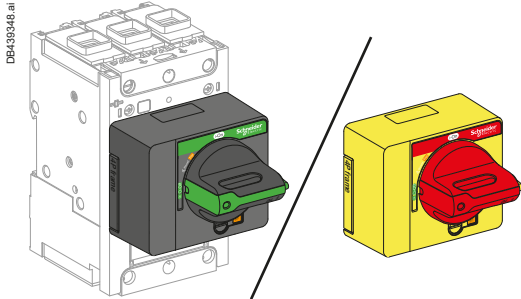

Directly mounted rotary handle

Direct Rotary Handles

Installation

The direct mounted rotary handle has to be mounted by 3 screws on the front accessory cover.

Operation

The direct rotary handle maintains:

- Suitability for isolation
- Indication of the three positions OFF (O), ON (I) and tripped (Trip)
- Access to the "push-to-trip" button
- Visibility and access to the trip unit.

Device padlocking

The circuit breaker may be locked in the OFF position by using one to three padlocks (not supplied) or in ON position after customer modification of the rotary handle before installation, padlock shackle Ø4-8 mm. Locking in the ON position does not prevent the circuit breaker from tripping if a fault occurs. In this case, the handle remains in the ON position after the circuit breaker trips. Unlocking is required for the handle to go to the tripped then the OFF position.

Variations: door locking

Door locking built-in functionality can be activated by the customer to prevent opening the door when the circuit breaker is ON or in trip position. For exceptional situations, door locking can be temporarily disabled with a tool by qualified personnel to open the door when the circuit breaker is closed.

Models

- Standard with black handle.
- VDE type with red handle and yellow bezel for machine tool control.

Extended Rotary Handles

Installation

The door-mounted (extended) rotary handle is made up of:

- A unit that has to be screwed on the front accessory cover of the circuit breaker.
- An assembly (handle mechanism and front plate) on the door that is always secured in the same position, whether the circuit breaker is installed vertically or horizontally
- An adjustable extension shaft.

The handle mechanism is fixed with a nut (Ø22 mm) to make assembly easier. The Laser Square tool (GVAPL01) can be used to accurately align the hole on the door with the circuit breaker.

Operation when door is closed

The door mounted handle makes it possible to operate a circuit breaker installed in an enclosure from the front. The door mounted operating handle maintains:

- Suitability for isolation
- Indication of the three positions OFF (O), ON (I) and tripped (Trip)
- Visibility and access to trip unit when the door is open
- Degree of protection of the handle on the door: IP54 or IP65 as per 60520.

Mechanical door locking when device closed

A standard feature of the extended rotary handle is a locking function, built into the shaft, that disables door opening when the circuit breaker is in the ON or tripped positions.

Door locking can be temporarily disabled with a tool by qualified personnel to open the door without opening the circuit breaker. This operation is not possible if the handle is locked by a padlock.

Device and door padlocking

Padlocking locks the circuit breaker handle and disables door opening:

- Standard situation, in the OFF position, using 1 to 3 padlocks, shackle Ø4-8 mm, padlocks are not supplied
- For the black handle, with a voluntary modification of the door handle (to be done by the customer during installation), in the ON and OFF positions. Locking in the ON position does not prevent the circuit breaker from tripping if a fault occurs. In this case, the handle remains in the ON position after the circuit breaker trips. Unlocking is required for the handle to go to the tripped then the OFF position.

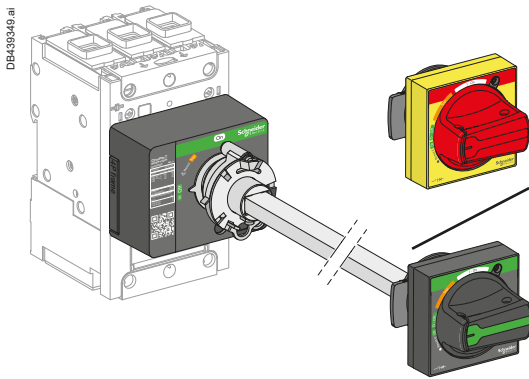

Door-mounted rotary handle

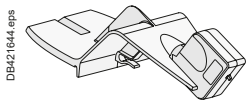

Laser Square tool

Customize Circuit Breakers with Accessories

ComPacT NSXm Accessories and Auxiliaries

Rotary Handles

Operation when door is opened

An open door shaft operator can be used to operate the circuit breaker when door is opened. This accessory complies with UL 508A.

The indication of the three positions OFF (O), ON (I) and tripped (Trip) is visible on the circuit breaker.

The circuit breaker itself may be locked in OFF position when the door is opened by 1 padlock/lockout hasp, shackle Ø4-8 mm.

Shaft length

The shaft length is the distance between the back of the circuit breaker and the door:

- Minimum shaft length is 200 mm
- Maximum shaft length is 600 mm
- Shaft length must be adjusted

Models

- Standard with black handle (IP54)
- VDE type with red handle and yellow bezel for machine tool control (IP54)
- IP65 with red handle and yellow bezel

Side Rotary Handles (Left or Right)

Installation

The side-mounted rotary handle is made up of:

- A unit that has to be screwed on the front accessory cover of the circuit breaker
- An assembly (handle and front plate) on the side (left or right) of the enclosure
- An adjustable extension shaft.

The handle mechanism is fixed with a nut (Ø22 mm) to make assembly easier.

Operation

The side mounted rotary handle makes it possible to operate circuit breakers installed in enclosure from the side. The side mounted rotary handle maintains:

- Suitability for isolation
- Indication of the three positions OFF (O), ON (I) and tripped (Trip). Moreover, the position is visible on the circuit breaker itself
- Visibility and access to trip unit when the door is open
- Degree of protection of the handle on the side: IP54 or IP65 as per IEC 60529.

Device padlocking

The circuit breaker may be locked in the OFF position, or, for the black rotary handle only, in ON position after voluntary modification of the side handle (to be done by the customer during installation), by using one to three padlocks, padlock shackle Ø4-8 mm ; padlocks are not supplied.

Locking in the ON position does not prevent free circuit breaker from tripping if a fault occurs. In this case, the handle remains in the ON position after the circuit breaker tripping. Unlocking is required to go to the tripped then the OFF position.

Shaft length

The shaft length is the distance between the side of the circuit breaker and the side of the enclosure:

- Minimum shaft length is 45 mm
- Maximum shaft length is 480 mm
- Shaft length must be adjusted.

Models

- Standard with black handle (IP54).
- VDE type with red handle and yellow bezel for machine tool control (IP54).
- IP65 with red handle and yellow bezel (by ordering a standard one and an IP65 universal handle).

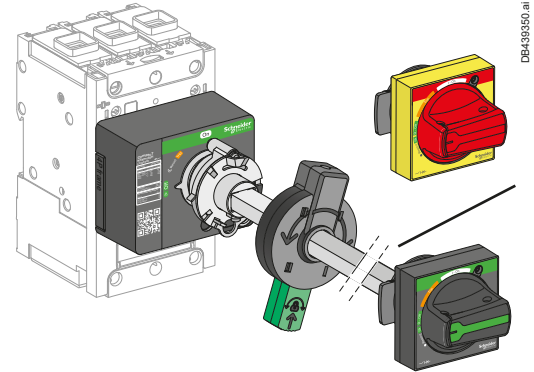

Door-mounted rotary handle with open door shaft operator

DB439350.ai

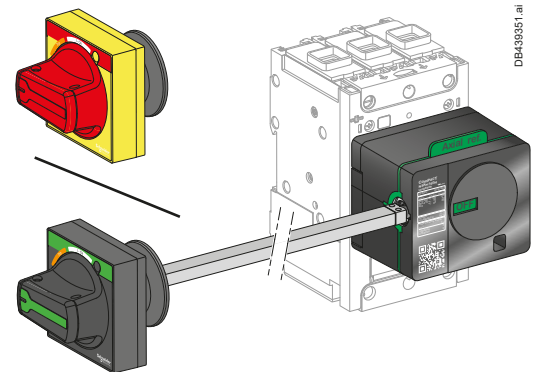

Side mounted rotary handle

DB439351.ai

C

ComPacT NSXm Accessories and Auxiliaries

Locks and Sealing Accessories

Locks

Padlocking systems can receive up to three padlocks with diameters of 5-8 mm ; padlocks not supplied. Locking in the OFF position isolates as per IEC 60947-2.

Control device	Function	Means	Required accessories
Toggle	Lock in OFF position	Padlock	Removable device
	Lock in OFF or ON position	Padlock	Fixed device
Direct rotary handle	Lock in OFF position	Padlock	Fixed device
	Lock in <ul style="list-style-type: none"> ■ OFF position ■ OFF or ON position ^[1] 	Padlock	-
Extended/side rotary handle	Lock in <ul style="list-style-type: none"> ■ OFF position ■ OFF or ON position ^[2] with door opening prevented 	Padlock	-

[1] Following a simple modification of the mechanism.

[2] Following a simple modification of the mechanism - black handle only.

Handle Padlocking Device ^[1]

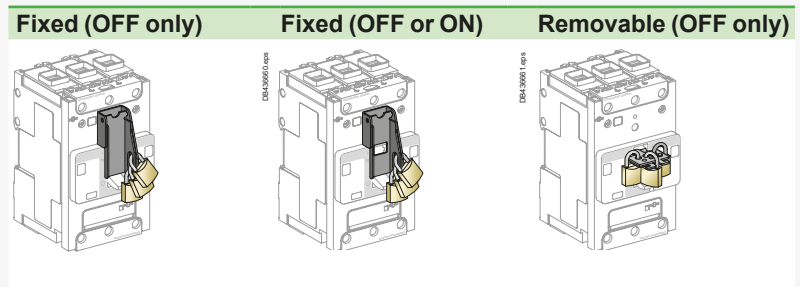

[1] Rotary handle has integrated padlocking capability.



Customize Circuit Breakers with Accessories

ComPacT NSXm Accessories and Auxiliaries

Locks and Sealing Accessories

Sealing Accessories

Sealing accessories are available. Each bag of accessories contains all the parts required for the types of sealing indicated below.

A bag contains:

- 6 sealing accessories
- 6 lead seals.

Types of Seals and Corresponding Functions

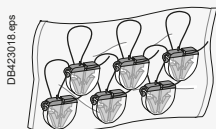

LV429335: Bag of sealing accessories

Protected operations			
Control type	<ul style="list-style-type: none"> ■ Front removal ■ Access to auxiliaries. 	<ul style="list-style-type: none"> ■ Access to power connections 	<ul style="list-style-type: none"> ■ Access to settings and test connector
Toggle			
Rotary handle			



ComPacT NSX Accessories and Auxiliaries

Overview Fixed Version

DB445833.ai

Sealable terminal shields

Interphase barriers

Cable connectors

Rear connectors

One-piece spreader

Terminal extensions

Direct rotary handle

Extended rotary handle

Motor mechanism

PowerTag NSX

VigiPacT NSX

Current transformer

BSCM Modbus SL/ULP

Modbus SL Cord

Indication contact

Wireless indication auxiliary

Voltage release

SDTAM module

SDx module

NSX cord



ComPacT NSX Accessories and Auxiliaries

Overview Plug-in and Withdrawable Versions

DB438221.ai

Sealable long terminal shields for plug-in base

Interphase barriers

Cable connectors

Rear connectors

Terminal extensions

Rear connectors

Lugs

Adapter

Automatic withdrawable auxiliary connector

Manual auxiliary connector

Chassis side plate

Adapter

PowerTag NSX

[1]

Power connections

Power connections for VigiPacT add-on

Circuit breaker side plate

[1] For PowerLogic PowerTag NSX 630 A, add a 4 mm intercalary under the module when plate mounted (see page C-47).



ComPacT NSX Accessories and Auxiliaries

Device Installation

Plug-in Circuit Breakers

The plug-in version makes it possible to:

- Extract and/or rapidly replace the circuit breaker without having to touch the connections on the base
- Allow for the addition of future circuits by installing bases that will be equipped with a circuit breaker at a later date
- Isolate the power circuits when the device is mounted on or through a panel. It acts as a barrier for the connections of the plug-in base. Insulation is made complete by the mandatory short terminal shields on the device. The degrees of protection are:
 - Circuit breaker plugged in = IP4
 - Circuit breaker removed = IP2
 - Circuit breaker removed, base equipped with shutters = IP4.

Parts of a plug-in configuration

A plug-in configuration is made by adding a "plug-in kit" to a fixed device. To avoid connecting or disconnecting the power circuits under load conditions, a safety trip causes automatic tripping if the device is ON, before engaging or withdrawing it. The safety trip, supplied with the kit, must be installed on the device. If the device is disconnected, the safety trip does not operate. The device can be operated outside the switchboard.

Accessories

Optional insulation accessories are available.

- Terminal shields to protect against direct contact.
- Interphase barriers to reinforce insulation between phases and to protect against direct contact.

Mounting

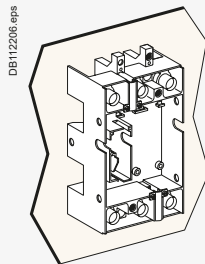

Mounting on a backplate

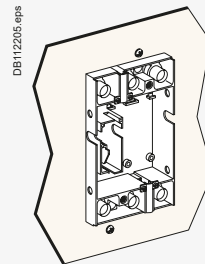

Mounting through a front panel

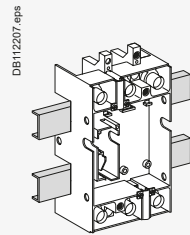

Mounting on rails

Customize Circuit Breakers with Accessories

ComPacT NSX Accessories and Auxiliaries

Device Installation

Withdrawable Circuit Breakers

In addition to the advantages provided by the base, installation on a chassis facilitates handling. It offers three positions, with transfer from one to the other after mechanical unlocking:

- Connected: the power circuits are connected.
- Disconnected: the power circuits are disconnected, the device can be operated to check auxiliary operation.
- Removed: the device is free and can be removed from the chassis.

Parts of a withdrawable configuration

A withdrawable configuration requires two side plates installed on the base and two sides plates mounted on the circuit breaker. Similar to the plug-in version, a safety trip causes automatic tripping if the device is ON, before engaging or withdrawing it, and enables device operation in the disconnected position.

Accessories

Accessories are the same as for the base, with in addition:

- Auxiliary contacts for installation on the fixed part, indicating the "connected" and "disconnected" positions.
- Locking by 1 to 3 padlocks (shackle diameter 5 to 8 mm), to:
 - Prevent insertion for connection
 - Lock the circuit breaker in connected or disconnected position.
- Toggle collar for circuit breakers with a toggle mounted through a front panel, intended to maintain the degree of protection whatever the position of the circuit breaker (supplied with a toggle extension).
- Telescopic shaft for extended rotary handles. The door can then be closed with the device in the connected and disconnected positions.

DB425377.eps

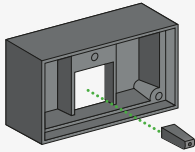

Protection collar for toggle and toggle extension to provide IP4 in the connected and disconnected positions

DB112219.eps

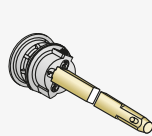

Telescopic shaft

Mounting

DB112220.eps

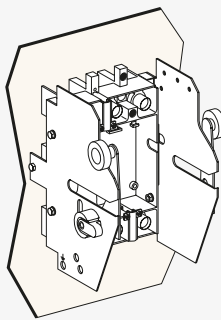

Mounting on a backplate

DB112221.eps

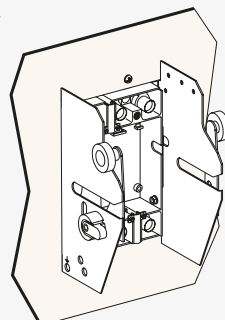

Mounting through a front panel

DB112312.eps

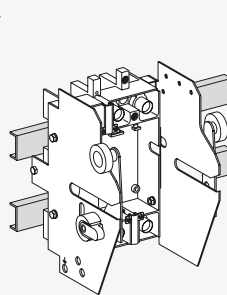

Mounting on rails



Withdrawable ComPacT NSX250

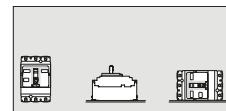

Installation positions



Connected

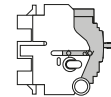

Disconnected

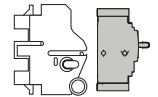

Removed

PB105122_0.eps

DB436655.eps

DB436656.eps

ComPacT NSX Accessories and Auxiliaries

Connection of Fixed Devices

Fixed circuit breakers are designed for standard front connection using bars or cables with lugs. Cable connectors are available for bare cables. Rear connection is also possible.

Front Connection

Bars or Cables with Lugs

Standard terminals

ComPacT NSX100 to 630 come with terminals comprising snap-in nuts with screws:

- ComPacT NSX100: M6 nuts and screws. ComPacT NSX160/250: M8 nuts and screws
- ComPacT NSX400/630: M10 nuts and screws.

These terminals may be used for:

- Direct connection of insulated bars or cables with lugs
- Terminal extensions offering a wide range of connection possibilities.

Interphase barriers or terminal shields are recommended. They are mandatory for certain connection accessories (in which case the interphase barriers are provided).

Bars

When non-insulated bars are used, a complete switchboard type test is mandatory to verify the switchboard configuration.

Maximum size of bars

ComPacT NSX circuit breaker		100/160/250	400/630
Without spreaders	pitch (mm)	35	45
	maximum bar size (mm)	20 x 2	32 x 6
With spreaders	pitch (mm)	45	52.5
	maximum bar size (mm)	32 x 2	40 x 10

Crimp lugs

There are two models, for aluminium and copper cables.

It is necessary to use narrow lugs, compatible with device connections. They must be used with interphase barriers or long terminal shields. The lugs are supplied with interphase barriers and may be used for the types of cables listed below.

Cable sizes for connection using lugs

ComPacT NSX circuit breaker		100/160/250	400/630
Copper cables	size (mm ²)	120, 150, 185	240, 300
	crimping	hexagonal barrels or punching	
Aluminium cables	size (mm ²)	120, 150, 185	240, 300
	crimping	hexagonal barrels	

Terminal extensions

Extensions with anti-rotation ribs can be attached to the standard terminals to provide numerous connection possibilities in little space:

- Straight terminal extensions
- Right-angle terminal extensions
- Edgewise terminal extensions
- Double-L extensions
- 45° extensions.

Spreaders

Spreaders may be used to increase the pitch:

- NSX100 to 250: the 35 mm pitch can be increased to 45 mm
- NSX400/630: the 45 mm pitch can be increased to 52 or 70 mm.

Bars, cable lugs or cable connectors can be attached to the ends.

One-piece spreader for NSX100 to 250

Connection of large cables may require an increase in the distance between the device terminals.

The one-piece spreader is the means to:

- Increase the 35 mm pitch of the NSX100 to 250 circuit-breaker terminals to the 45 mm pitch of a NSX400/630 device
- Use all the connection and insulation accessories available for the next largest frame size (lugs, connectors, spreaders, right-angle and edgewise terminal extensions, terminal shields and interphase barriers).

It may also be used for ComPacT INS switch-disconnectors.

Equipped with a single-piece spreader, ComPacT NSX devices can be mounted:

- At the back of a switchboard
- Behind the front panel with a raiser.

The one-piece spreader is also the means to:

- Align devices with different frame sizes in the switchboard
- Use the same mounting plate, whatever the device.

Pitch (mm) depending on the type of spreader

ComPacT NSX circuit breaker	NSX100 to 250	NSX400 to 630
Without spreaders	35	45
With spreaders	45	52.5 or 70
With one-piece spreader	45	-

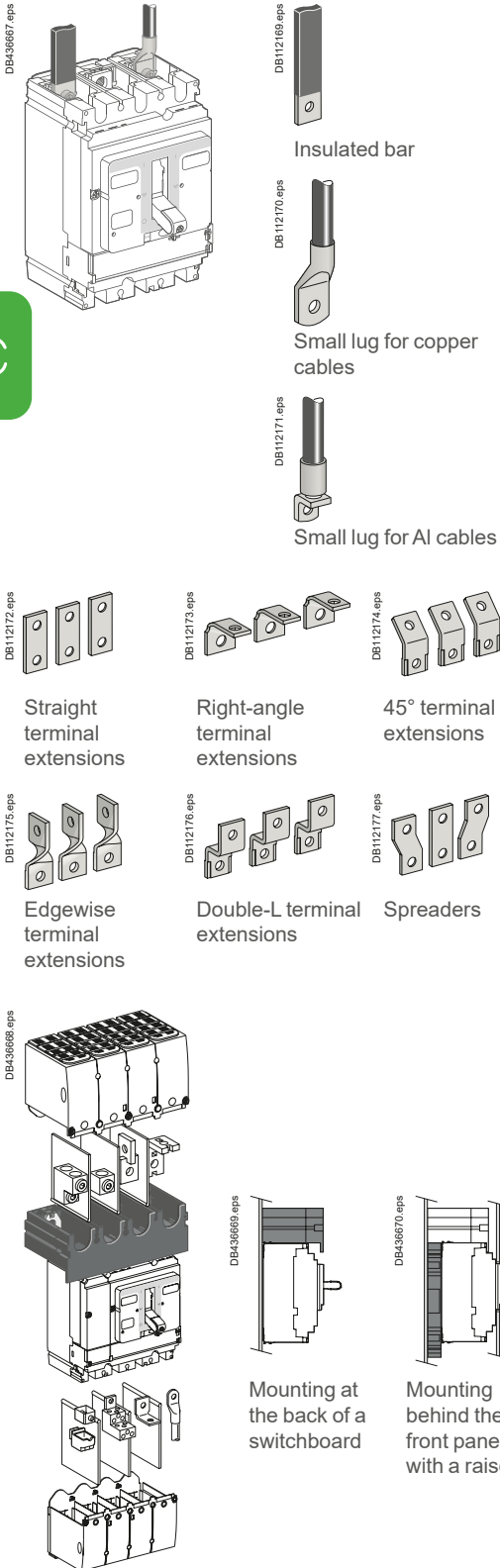

ComPacT NSX Accessories and Auxiliaries

Connection of Fixed Devices

Rear Connection

Device mounting on a backplate with suitable holes enables rear connection.

Bars or Cables with Lugs

Rear connections for bars or cables with lugs are available in two lengths. Bars may be positioned flat, on edge or at 45° angles depending on how the rear connections are positioned.

The rear connections are simply fitted to the device connection terminals. All combinations of rear connection lengths and positions are possible on a given device.

Bare Cables

For the connection of bare cables, the 1-cable connectors for ComPacT NSX100 to 250 may be secured to the rear connections using clips.

Linery Connections

Linery DX and Linery DP distribution block for ComPacT NSX100 to 630

Linery DX and Linery DP connects directly to device terminals. It is used to connect up to six or nine flexible or rigid cables with cross-sectional areas not exceeding 10 mm² or 16 mm², to each pole. Connection is made to spring terminals without screws.

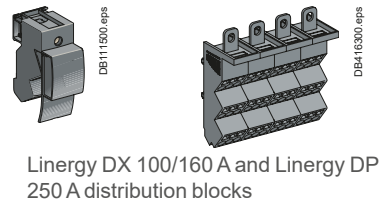
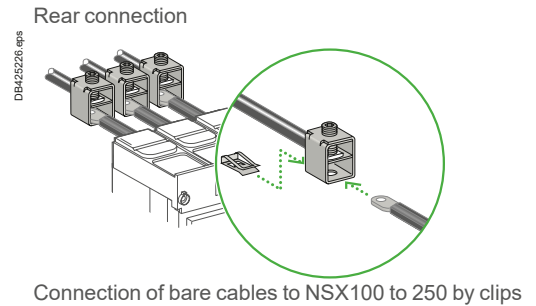
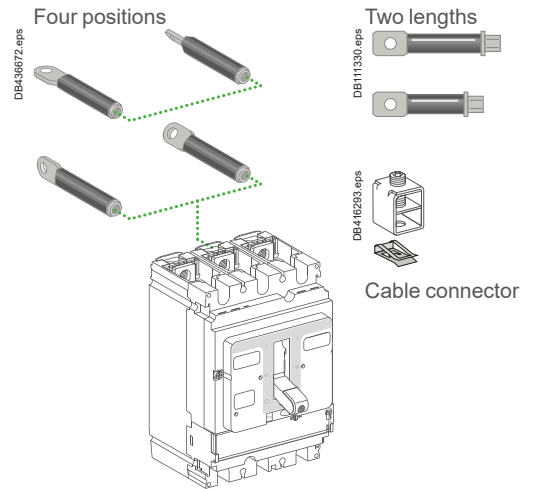

ComPacT NSX Accessories and Auxiliaries

Connection of Fixed Devices

Bare Cables

For bare cables (without lugs), the prefabricated bare-cable connectors may be used for both copper and aluminium cables.

1-cable connectors up to 185mm² for ComPacT NSX100 to 250

The connectors snap directly on to the device terminals or are secured by clips to right-angle and straight terminal extensions as well as spreaders.

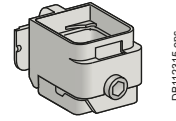

DB112315.eps

1-240 mm² cable and 2-cable connectors for ComPacT NSX100 to 250

The connectors are screwed to device terminals or right-angle terminal extensions.

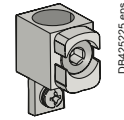

DB426225.eps

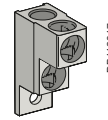

DB112317.eps

Distribution connectors for ComPacT NSX100 to 250

These connectors are screwed directly to device terminals. Interphase barriers are supplied with distribution connectors, but may be replaced by long terminal shields. Each connector can receive six cables with cross-sectional areas ranging from 1.5 to 35 mm² each.

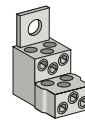

DB111327.eps

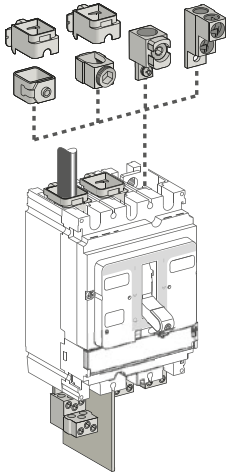

DB446008.eps

		ComPacT NSX 250A												
		ComPacT NSX 160A												
		ComPacT NSX 100A						ComPacT NSX 100A						
Connectors	Cable	Cu (mm ²)		Al (mm ²)		Cu (mm ²)		Al (mm ²)		Cu (mm ²)		Al (mm ²)		
		A	B	A	B	A	B	A	B	A	B	A	B	
LV429246 X2 LV429242 X3 LV429243 X4 LV429227 X3 LV429228 X4 LV429259 X3 LV429260 X4 LV429244 X3 LV429245 X4 LV429218 X3 LV429219 X4 LV429248 X3 LV429249 X4	250					120	185	120	240	2x70	2x120	6x25	6x35	
	225			95		120	185	120	185	2x50	2x95	6x25	6x35	
	200			95			150				2x70		6x25	
	160	70		70			120		120		2x50		6x16	
	150	50	95	50	95						2x50		6x16	
	125	50	95	50	95	120		120				6x6	6x16	
	100	35	70	35	70					2x50		6x4	6x10	
	80	25	50	25	50								6x10	
	63	16	25		25								6x6	
	50	10	16	25	25								6x4	
	40	10	16		25								6x4	
	32	6	10										6x1.5	6x4
	25	4	6											
	18	2.5	4										6x1.5	6x4
	16	2.5	4											
	11.2	1.5	4											
0														

The cable sections proposed are the minimum cross sections to be used with Schneider Electric products to comply with IEC 60947-2.

The selection of cable sections for your application must comply with our specifications and temperature rise tests must be checked according to IEC 61 439.

Copper cables used with all our lug connectors must be class 2, class 5 (IEC 60228) or class b/c (UL 1007/UL 1569).

Aluminum cables used with all our lug connectors must be class 2 (IEC 60228) or class b (UL1007/UL 1569).



Instruction Sheet ComPacT NSX100-250

- Possible just for tmd 16 set at 0,7 in
- Use a MicroLogic trip unit
- Class 1 cable or with ferrule
- Select the screw size according to the instruction sheet
- Adapt the torque or select a screw size according to the Instruction Sheet information

Customize Circuit Breakers with Accessories

ComPacT NSX Accessories and Auxiliaries

Connection of Fixed Devices

1-cable connectors for ComPacT NSX400 to 630
The connectors are screwed directly to the device terminals.

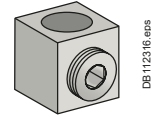

2-cable connectors for ComPacT NSX400 to 630
The connectors are screwed to device terminals or right-angle terminal extensions.

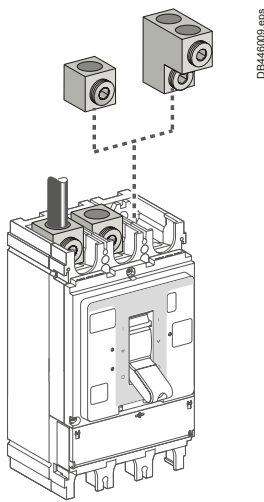
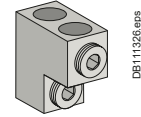

The cable sections proposed are the minimum cross sections to be used with Schneider Electric products to comply with IEC 60947-2. The selection of cable sections for your application must comply with our specifications and temperature rise tests must be checked according to IEC 61 439. Copper cables used with all our lug connectors must be class 2, class 5 (IEC 60228) or class b/c (UL 1007/UL 1569). Aluminum cables used with all our lug connectors must be class 2 (IEC 60228) or class b (UL1007/UL 1569).

		ComPacT NSX 630A			
		ComPacT NSX 400A			
Connectors					
	LV432479 X3 LV432480 X4	LV432481 X3 LV432482 X4			
	Cable				
	Cu (mm ²)	Al (mm ²)	Cu (mm ²)	Al (mm ²)	
A					
ComPacT NSX 630A			2x185	2x240	
ComPacT NSX 400A			2x150	2x240	
630			2x120	2x150	
500	300		2x95	2x150	
400	240		2x95	2x120	
300	185	300	2x35	2x95	
250	120		2x35	2x35	
225	95			2x35	
200	95				
160	70				
150	50				
100	35	70			
0					



Instruction Sheet
ComPacT NSX400-630

Adapt the torque or select a screw size according to the Instruction Sheet information

Adapt the torque or select a screw size according to the Instruction Sheet information

Use a MicroLogic trip unit

ComPacT NSX Accessories and Auxiliaries

Connection of Withdrawable and Plug-in Devices

Connection is identical for both withdrawable and plug-in versions. The same accessories as for fixed devices may be used.

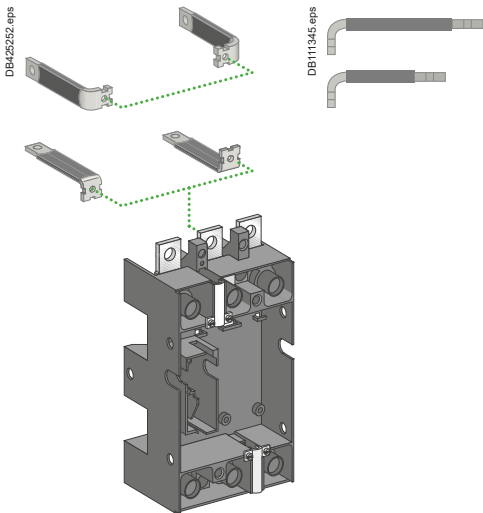

Four positions

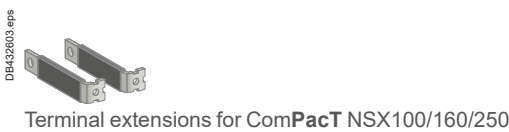

Terminal extensions for ComPacT NSX100/160/250



Terminal extensions for ComPacT NSX400/630

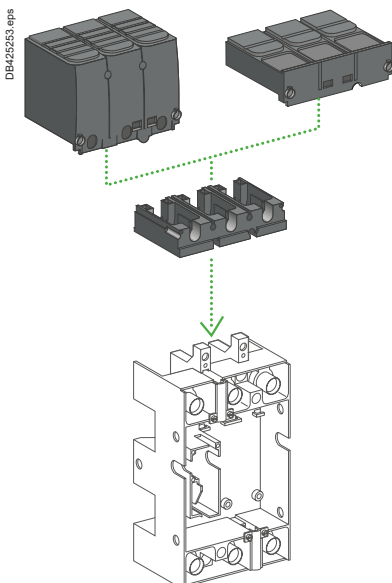

Bars or Cables with Lugs

The plug-in base is equipped with terminals which, depending on their orientation, serve for front and rear connection.

For rear connection of a base mounted on a backplate, the terminals must be replaced by insulated, long right-angle terminal extensions.

For ComPacT NSX630 devices, connection most often requires the 52.5 or 70 mm pitch spreaders.

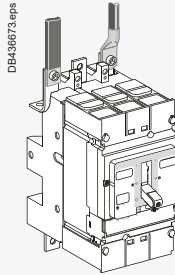

Front connection

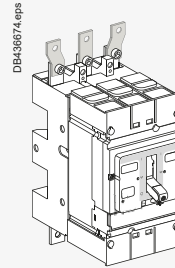

Front connection with spreaders

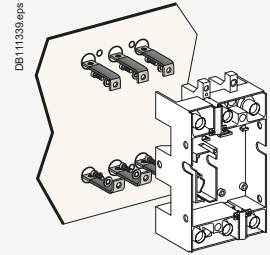

Rear connection of a base mounted on a backplate

Connection accessories

All accessories for fixed devices (bars, lugs, terminal extensions and spreaders) may be used with the plug-in base, with specific adaptators for the plug-in base.

Bare Cables

All terminals may be equipped with bare-cable connectors. See the "Connection of fixed devices" section.

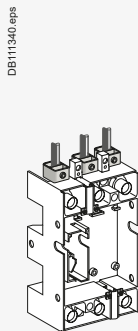

With a 100 to 250 A base

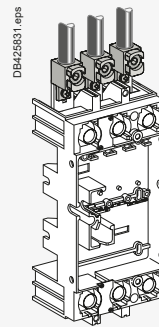

With 240 mm² cable connector for NSX100 to 250

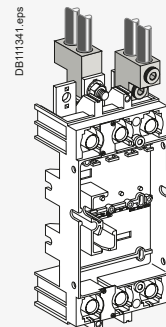

With a 400/630 A base

Adapter for Plug-in Base

The adapter is a plastic component for the 100 to 250 base and the 400/630 base that enables use of all the connection accessories of the fixed device.

It is required for interphase barriers and the long and short terminal shields.

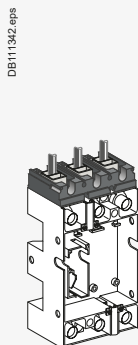

Adapter for 100 to 250 A - 3P base. Connection with bars or cables with lugs

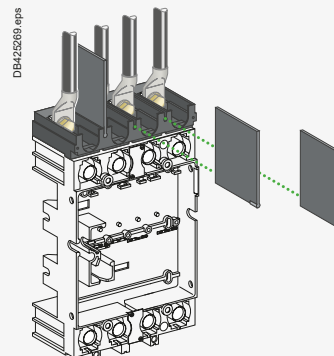

Adapter for 400/630 A - 4P base. Connection with spreaders and interphase barriers

ComPacT NSX Accessories and Auxiliaries

Insulation of Live Parts

Terminal Shields

Insulating accessories used for protection against direct contact with power circuits. They provide IP40 degree of protection and IK07 mechanical impact protection.

Terminal-shield types

ComPacT NSX100 to 250 and NSX400/630 3P or 4P can be equipped with:

- Short terminal shields
- Short terminal shields ≥ 500 V
- Long terminal shields.

All terminal shields have holes or knock-outs in front for voltage-measurement indicators.

Short terminal shields

They are used with:

- Plug-in and withdrawable versions in all connection configurations
- Fixed versions with rear connection.

Long terminal shields

They are used for front connection with cables or insulated bars.

They comprise two parts assembled with captive screws, forming an IP40 cover.

- The top part is equipped with sliding grids with break marks for precise adaptation to cables or insulated bars.
- The rear part completely blocks off the connection zone. Partially cut squares can be removed to adapt to all types of connection for cables with lugs or copper bars. Long terminal shields may be mounted upstream and downstream of:
- Fixed devices
- The base of plug-in and withdrawable versions, thus completing the insulation provided by the mandatory short terminal shields on the device
- The one-piece spreader for NSX100 to 250
- The 52.5 mm spreaders for NSX400/630.

Terminal shields and pitch

Combination possibilities are shown below.

Circuit breaker	NSX100/160/250	NSX400/630	
Short terminal shields			
Pitch (mm)	35	45	
Long terminal shields			
Pitch (mm)	35	45	52.5

Interphase Barriers

Accessories for maximum insulation at the power-connection points:

- They clip easily onto the circuit breaker
- Single version for fixed devices and adapters on plug-in bases
- Not compatible with terminal shields
- The adapter for the plug-in base is required for mounting on plug-in and withdrawable versions.

Rear Insulating Screens

Accessories providing insulation at the rear of the device.

Their use is mandatory for devices with spreaders, installed on backplates, when terminal shields are not used.

The available screen dimensions are shown below.

Circuit breaker	NSX100/160/250	NSX400/630
3P W x H x thickness (mm)	140 x 105 x 1	203 x 175 x 1.5
4P W x H x thickness (mm)	175 x 105 x 1	275 x 175 x 1.5

Terminal shields are identical for fixed and plug-in/withdrawable versions and cover all applications up to 1000 V. They exist for the 100 to 250 A and 400/630 A ratings, in long and short versions.

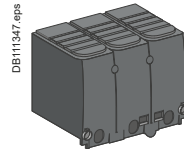

Long terminal shields

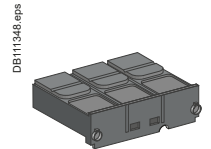

Short terminal shields

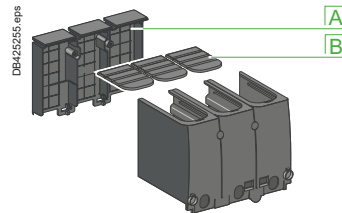

- A** Partially cut removable squares
- B** Grids with break marks

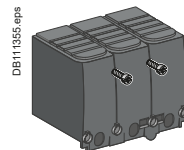

Assembled with captive screws

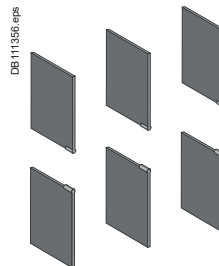

Interphase barriers

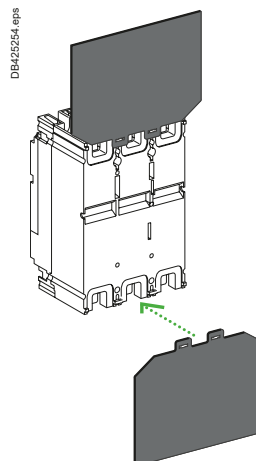

Rear insulating screens



ComPacT NSX Accessories and Auxiliaries

Selection of Auxiliaries for NSX100/160/250

Standard

All ComPacT NSX100/160/250 circuit breakers and switch-disconnectors have slots for the electrical auxiliaries listed below.

5 indication contacts (see page C-34)

- 2 ON/OFF (OF1 and OF2)
- 1 trip indication (SD)
- 1 fault-trip indication (SDE)
- 1 earth-fault indication (SDV), when the device is equipped with a VigiPacT add-on.

1 remote-tripping release (see page C-37)

- Either 1 MN undervoltage release
- Or 1 MX shunt release.

Remote Indications

Circuit breakers equipped with MicroLogic trip units may be equipped with a fault-trip indication to identify the type of fault by installing:

1 indication module with two outputs (see page C-35)

- Either an SDx module with MicroLogic 2.2/4.2/5.2 E/6.2 E or 7 E
- Or an SDTAM module with MicroLogic 2.2 M or 6-2 E-M (motor protection).

This module occupies the slots of one OF contact and an MN/MX release.

All these auxiliaries may be installed with a motor mechanism or a rotary handle or a toggle handle.

The following table indicates auxiliary possibilities depending on the type of trip unit.

NA, TMD, TMG, MA

Standard

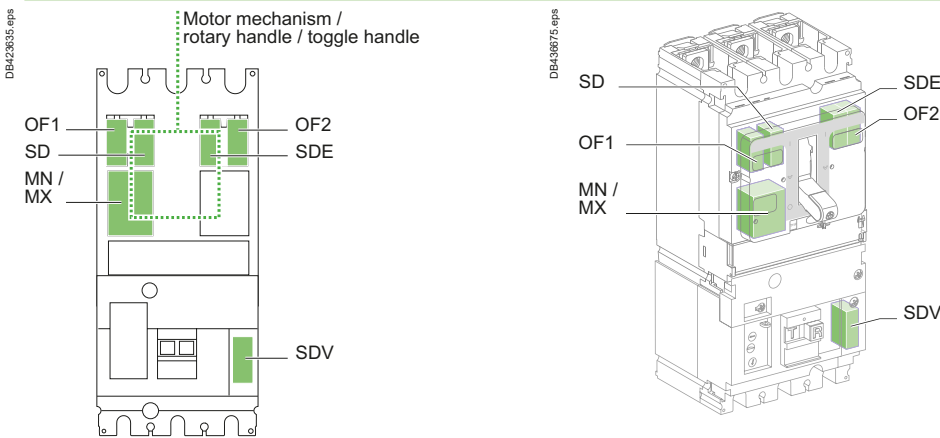

MicroLogic 2/4/5/6/7

Standard

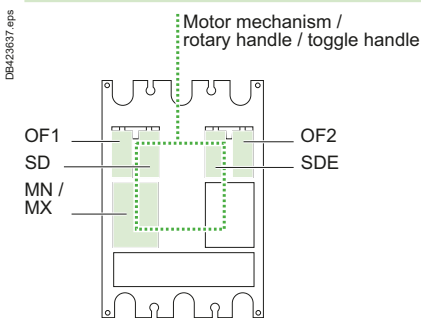

Remote indications via SDx or SDTAM

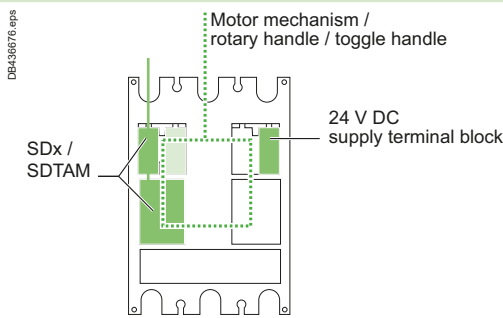

The SDx or SDTAM uses the OF1 and MN/MX slots. External connection is made via a terminal block in the OF1 slot. The 24 V DC supply provides for the MicroLogic 5/6/7 display when the device is OFF or under low-load conditions.

Customize Circuit Breakers with Accessories

ComPacT NSX Accessories and Auxiliaries

Selection of Auxiliaries for NSX100/160/250

Communication

Communication requires specific auxiliaries.

The BSCM Modbus SL/ULP module can be used in the following modes:

- Modbus SL only mode
- Modbus SL and ULP mode
- ULP only mode

Communication of status indications

- 1 BSCM Modbus SL/ULP module with corresponding 1 BSCM SL Cord and 1 Modbus SL Hub (could be used to connect 3 BSCM Modbus SL/ULP) if requested communication protocol is Modbus SL.
- 1 BSCM Modbus SL with 1 NSX cord if requested communication protocol is ULP. NSX Cord for both communication and 24 V DC supply to the BSCM. The insulated NSX cord is mandatory for system voltages greater than 480 V AC.

Communication of status conditions is compatible with a toggle handle and a rotary handle.

Communication of status indications and controls

This requires, in addition to the previous auxiliaries:

- 1 communicating motor mechanism connected to the BSCM Modbus SL/ULP together with accessory LV434210 for SD status indication.

Communication of measurements

Available on MicroLogic 5/6/7, the system consists of:

- 1 BSCM with 1 Modbus SL Cord and 1 Modbus Hub to communicate information from the trip unit to the gateway and SCADA in Modbus SL mode.
- 1 NSX cord (internal terminal block) for both communication and 24 V DC supply to the MicroLogic in ULP mode.

Communication of measurements is compatible with a standard or communicating motor mechanism and a rotary handle.

Communication of status indications, controls and measurements

Available on MicroLogic 5/6/7, the system consists of:

- 1 BSCM with 1 Modbus SI Cord and 1 Modbus Hub to communicate information from the trip unit to the gateway and SCADA in Modbus SL mode.
- 1 NSX cord (internal terminal block) for both communication and 24 V DC supply to the MicroLogic in ULP mode.
- 1 communicating motor mechanism connected to the BSCM.

Installation of SDx or SDTAM is compatible with communication. The following table indicates auxiliary possibilities depending on the type of trip unit.

The following table indicates auxiliary possibilities depending on the type of trip unit.

ComPacT NSX Accessories and Auxiliaries

Selection of Auxiliaries for NSX100/160/250

NA, TMD, TMG, MA, MicroLogic 2/4 in Modbus SL mode

Communication of status indications

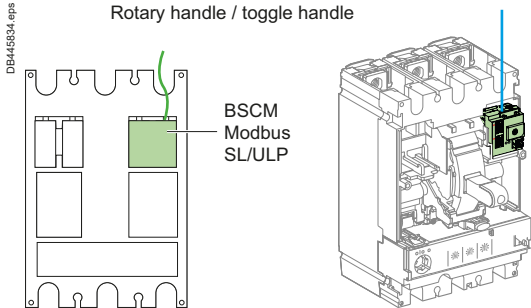

or

Communication of status indications and controls

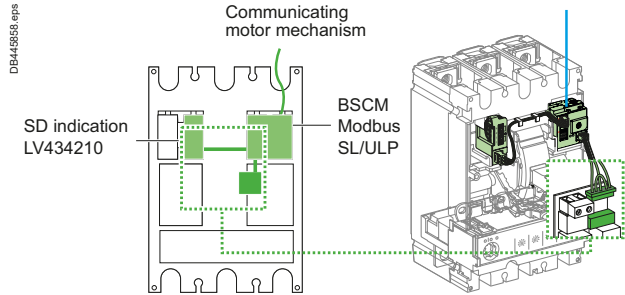

NA, TMD, TMG, MA, MicroLogic 2/4 in ULP mode

Communication of status indications

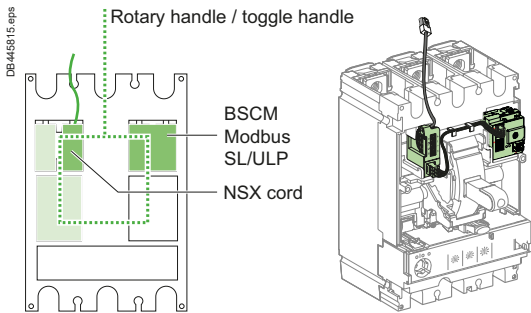

or

Communication of status indications and controls

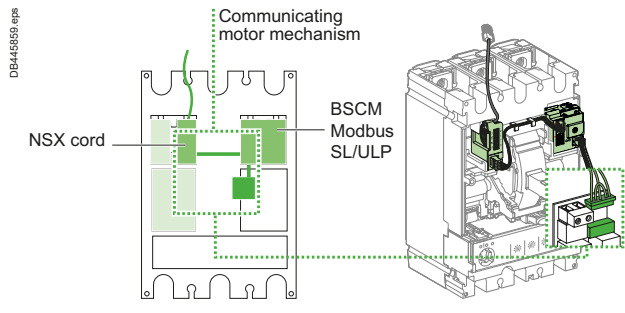

MicroLogic 5/6/7

Communication of measurements with or without FDM121 display

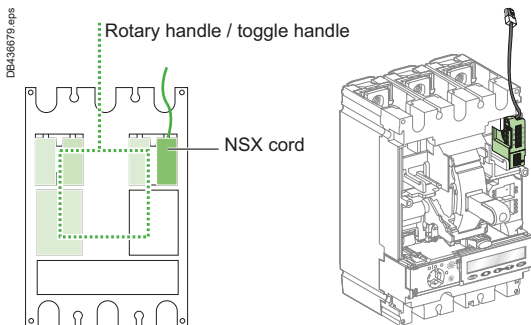

or

Communication of status indications, controls and measurements

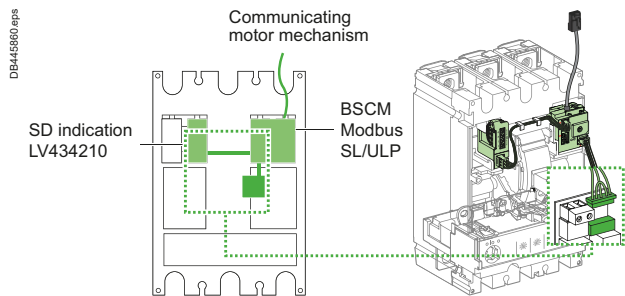

Customize Circuit Breakers with Accessories

ComPacT NSX Accessories and Auxiliaries

Selection of Auxiliaries for NSX400/630

Standard

All ComPacT NSX400/630 circuit breakers and switch-disconnectors have slots for the electrical auxiliaries listed below.

7 indication contacts (see page C-34)

- 4 ON/OFF (OF1, OF2, OF3, OF4)
- 1 trip indication (SD)
- 1 fault-trip indication (SDE)
- 1 earth-fault indication (SDV), when the device is equipped with a VigiPacT add-on.

1 remote-tripping release (see page C-37)

- Either 1 MN undervoltage release
- Or 1 MX shunt release.

Remote Indications

Circuit breakers equipped with MicroLogic trip units may be equipped with a fault-trip indication to identify the type of fault by installing:

1 indication module with two outputs (see page C-35)

- Either an SDx module with MicroLogic 2.3/4.3/5.3 E/6.3 E or 7 E
- Or an SDTAM module with MicroLogic 2.3 M or 6-3 E-M (motor protection).

This module occupies the slots of an MN/MX release.

All these auxiliaries may be installed with a motor mechanism or a rotary handle or a toggle handle.

The following table indicates auxiliary possibilities depending on the type of trip unit.



NA, MicroLogic 1.3 M

Standard

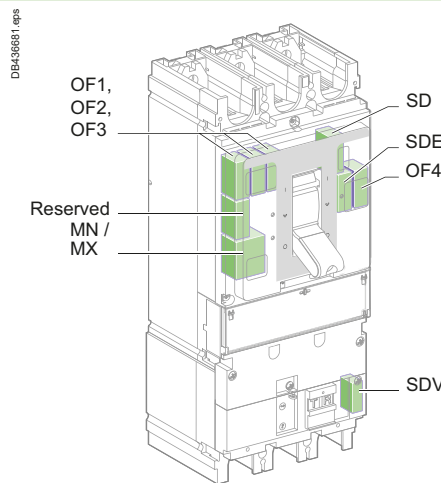
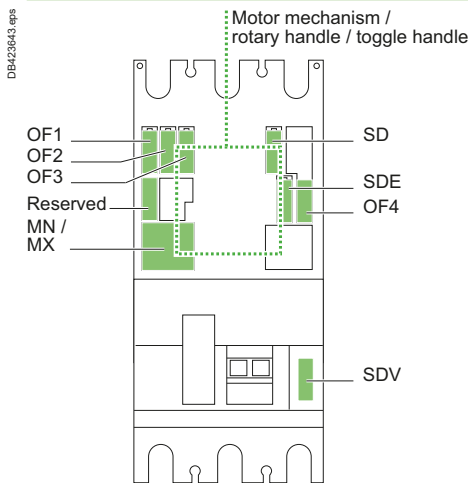

MicroLogic 2/4/5/6/7

Standard

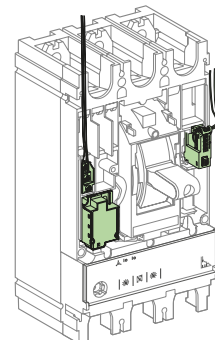
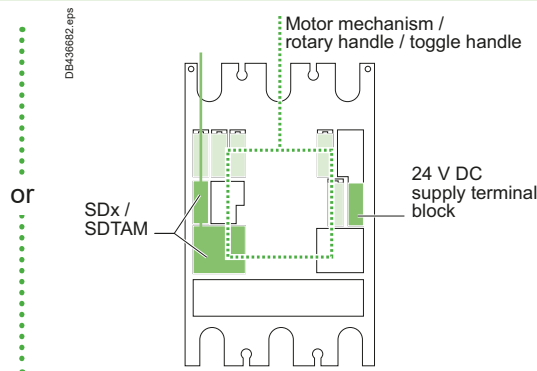
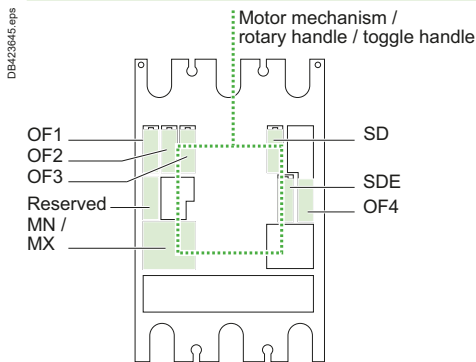

The SDx or SDTAM uses the reserved slot and the MN/MX slots. External connection is made via a terminal block in the reserved slot. The 24 V DC supply provides for the MicroLogic 5/6/7 display when the device is OFF or under low-load conditions.

ComPacT NSX Accessories and Auxiliaries

Selection of Auxiliaries for NSX400/630

Communication

Communication requires specific auxiliaries.

The BSCM Modbus SL/ULP module can be used in the following modes:

- Modbus SL only mode
- Modbus SL and ULP mode
- ULP only mode

Communication of status indications

- 1 BSCM Modbus SL/ULP module with corresponding 1 BSCM SL Cord and 1 Modbus SL Hub (could be used to connect 3 BSCM Modbus SL/ULP) if requested communication protocol is Modbus SL.
- 1 BSCM Modbus SL with 1 NSX cord if requested communication protocol is ULP. NSX Cord for both communication and 24 V DC supply to the BSCM. The insulated NSX cord is mandatory for system voltages greater than 480 V AC.

Communication of status conditions is compatible with a toggle handle and a rotary handle.

Communication of status indications and controls

This requires, in addition to the previous auxiliaries:

1 communicating motor mechanism connected to the BSCM Modbus SL/ULP together with accessory LV434210 for SD status indication.

Communication of measurements

Available on MicroLogic 5/6/7, the system consists of:

- 1 BSCM with 1 Modbus SL Cord and 1 Modbus Hub to communicate information from the trip unit to the gateway and SCADA in Modbus SL mode.
- 1 NSX cord (internal terminal block) for both communication and 24 V DC supply to the MicroLogic in ULP mode.

Communication of measurements is compatible with a standard or communicating motor mechanism and a rotary handle.

Communication of status indications, controls and measurements

Available on MicroLogic 5/6/7, the system consists of:

- 1 BSCM with 1 Modbus SI Cord and 1 Modbus Hub to communicate information from the trip unit to the gateway and SCADA in Modbus SL mode.
- 1 NSX cord (internal terminal block) for both communication and 24 V DC supply to the MicroLogic in ULP mode.
- 1 communicating motor mechanism connected to the BSCM.

Installation of SDx or SDTAM is compatible with communication. The following table indicates auxiliary possibilities depending on the type of trip unit.



Customize Circuit Breakers with Accessories

ComPacT NSX Accessories and Auxiliaries

Selection of Auxiliaries for NSX400/630

NA, MicroLogic 1.3 M, MicroLogic 2/4 In Modbus SL mode

Communication of status indications

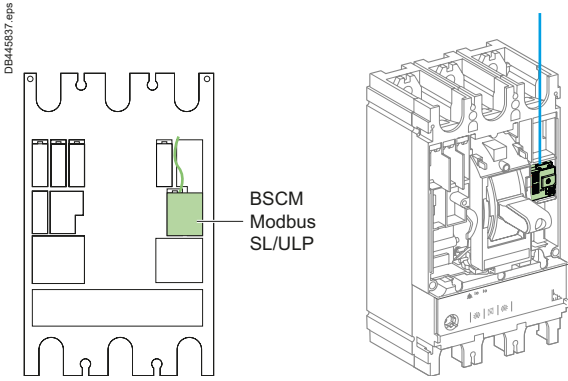

Communication of status indications and controls

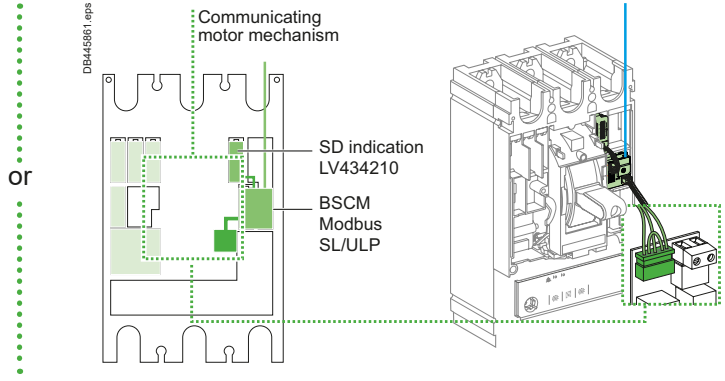

MicroLogic 5/6/7 In ULP mode

Communication of measurement with or without FDM121 display

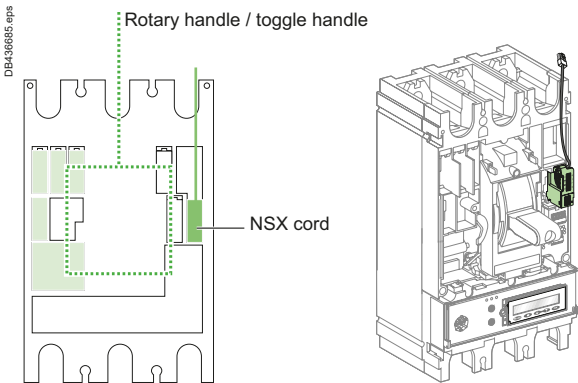

Communication of status indications, controls and measurements with or without FDM121 display

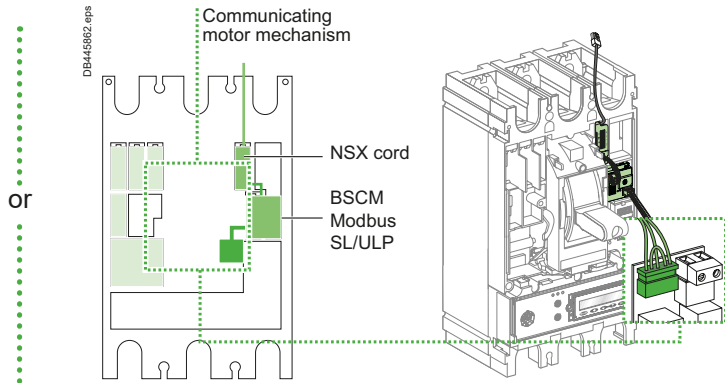

ComPacT NSX Accessories and Auxiliaries

Connection of Electrical Auxiliaries

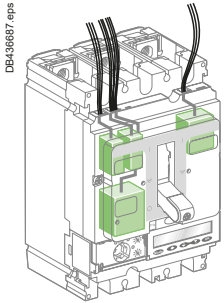

Fixed ComPacT NSX

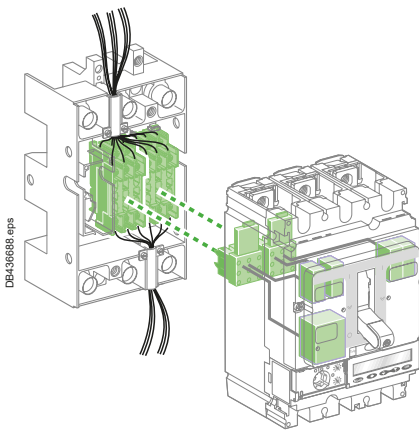

Plug-in/withdrawable ComPacT NSX

Fixed ComPacT NSX

Auxiliary circuits exit the device through a knock-out in the front cover.

Withdrawable or Plug-in ComPacT NSX

Automatic Auxiliary Connectors

Auxiliary circuits exit the circuit breaker via one to three automatic auxiliary connectors (nine wires each). These are made up of:

- A moving part, connected to the circuit breaker via a support (one support per circuit breaker)
- A fixed part, mounted on the plug-in base, equipped with connectors for bare cables up to 2.5 mm².

MicroLogic trip unit options are also wired via the automatic auxiliary connectors.

Selection of automatic auxiliary connectors

Depending on the functions installed, one to three automatic auxiliary connectors are required.

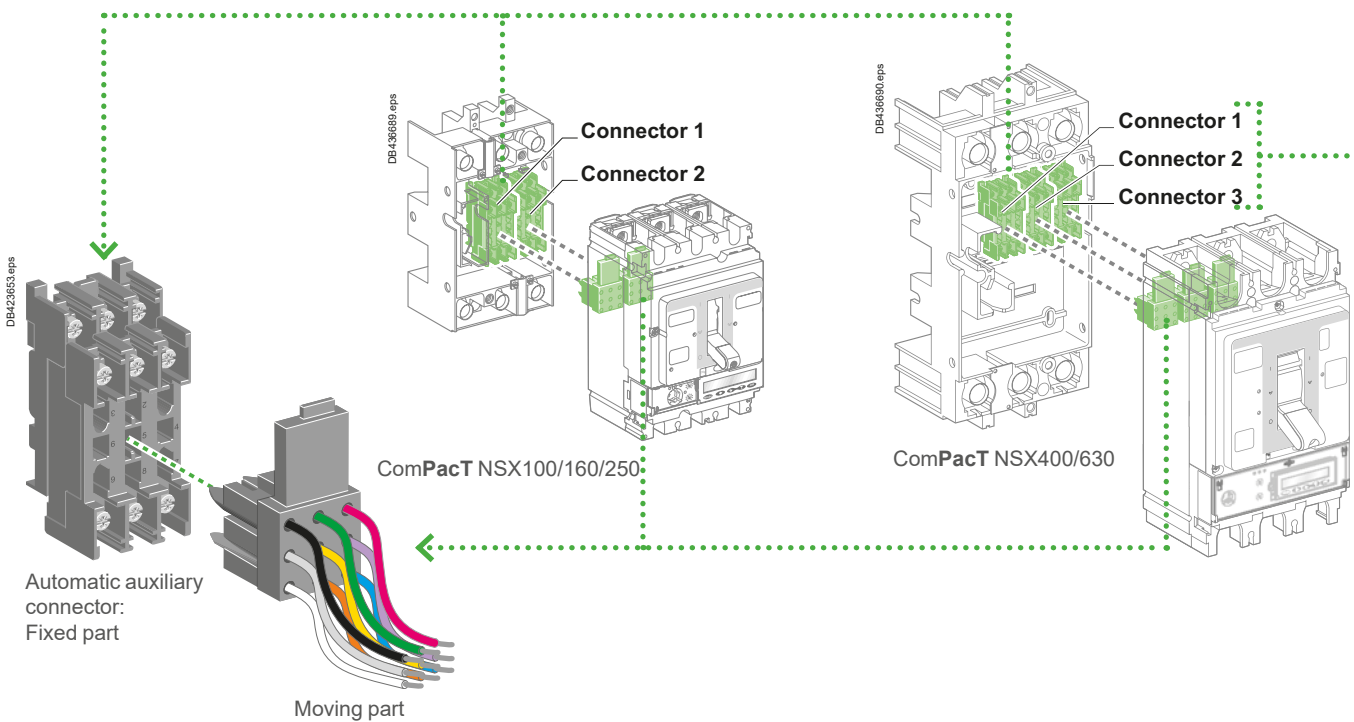

Customize Circuit Breakers with Accessories

ComPacT NSX Accessories and Auxiliaries

Connection of Electrical Auxiliaries

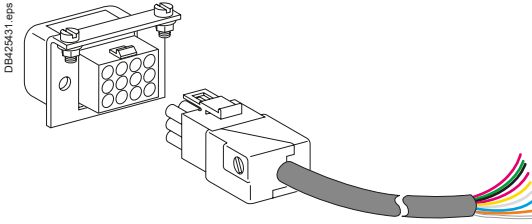

Nine-wire manual auxiliary connector

Withdrawable ComPacT NSX

Manual Auxiliary Connectors

As an option to the automatic auxiliary connectors, withdrawable circuit breakers may be equipped with one to three plugs with nine wires each. In "disconnected" position, the auxiliaries remain connected. They can then be tested by operating the device.

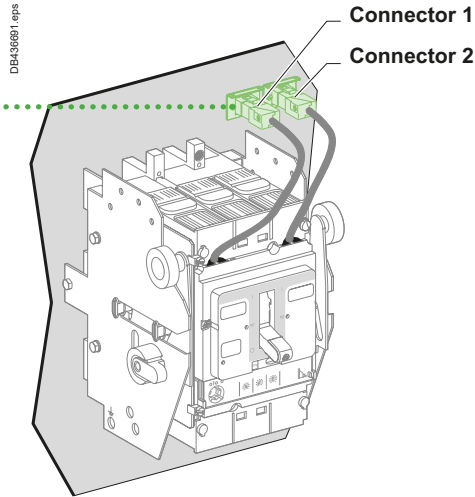

ComPacT NSX100/160/250

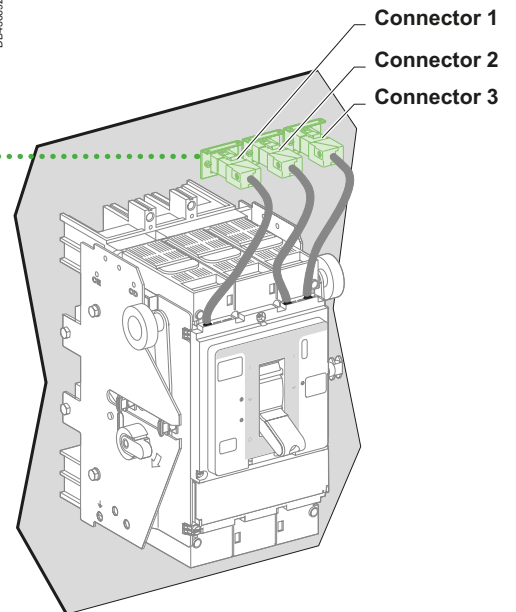

ComPacT NSX400/630

Each auxiliary is equipped with a terminal block with numbered terminals for connection of wires up to:

- 1.5 mm² for auxiliary contacts and voltage releases
- 2.5 mm² for the motor-mechanism module.

Circuit breaker	Connector 1	Connector 2	Connector 3
	OF1 MN/MX or SDx/ SD or SDTAM	OF2/SDV ^[1] /ZSI out ^[1] SDE NSX cord MT MTc 24 V DC	OF3 OF4 ZSI in ZSI out SDV
NSX100/160/250	●	●	-
NSX400/630	●	●	●

[1] Only for NSX100 to 250.

MT: motor mechanism

MTc: communicating motor mechanism



ComPacT NSX Accessories and Auxiliaries

Indication Contacts

One contact model provides circuit-breaker status indications (OF - SD - SDE - SDV).
 An early-make or early-break contact, in conjunction with a rotary handle, can be used to anticipate device opening or closing.
 A CE/CD contact indicates that the chassis is connected/disconnected.



These common-point changeover contacts provide remote circuit-breaker status information.

They can be used for indications, electrical locking, relaying, etc.

They comply with the IEC 60947-5 international standards.

Terminals are spring type in order to ensure a fast and reliable connection.

Functions

Breaker-status indications, during normal operation or after a fault

A single type of contact provides all the different indication functions:

- OF (ON/OFF) indicates the position of the circuit breaker contacts
- SD (trip indication) indicates that the circuit breaker has tripped due to:
 - An overload
 - A short-circuit
 - An earth fault (Vigi) or a ground fault (MicroLogic 6)
 - Operation of a voltage release
 - Operation of the "push to trip" button
 - Disconnection when the device is ON.

The SD contact returns to de-energized state when the circuit breaker is reset.

- SDE (fault-trip indication) indicates that the circuit breaker has tripped due to:
 - An overload
 - A short-circuit
 - An earth fault (Vigi) or a ground fault (MicroLogic 6).

The SD contact returns to de-energized state when the circuit breaker is reset.

- SDV indicates that the circuit breaker has tripped due to an earth fault. It returns to de-energized state when the VigiPacT add-on is reset.

All the above auxiliary contacts are also available in "low-level" versions capable of switching very low loads (e.g. for the control of PLCs or electronic circuits).

Rotary-handle position contact for early-make or early-break functions

- CAM (early-make or early-break function) contacts indicate the position of the rotary handle.

They are used in particular for advanced opening of safety trip devices (early break) or to energize a control device prior to circuit-breaker closing (early make).

Chassis-position contacts

- CE/CD (connected/disconnected) contacts are microswitch-type carriage switches for withdrawable circuit breakers.

Installation

- OF, SD, SDE and SDV functions: a single type of contact provides all these different indication functions, depending on where it is inserted in the device. The contacts clip into slots behind the front cover of the circuit breaker (or the VigiPacT add-on for the SDV function).

The SDE function on a ComPacT NSX100-250 A equipped with a magnetic, thermal-magnetic or MicroLogic 2 trip unit requires the SDE actuator.

- CAM function: the contact fits into the rotary-handle unit (direct or extended).
- CE/CD function: the contacts clip into the fixed part of the chassis.

Electrical Characteristics of Auxiliary Contacts

Contacts	Standard					Low level				
	OF, SD, SDE, SDV					OF, SD, SDE, SDV				
Rated thermal current (A)	5					5				
Minimum load	100 mA at 24 V DC					1 mA at 4 V DC				
Utilization cat. (IEC 60947-5-1)	AC12	AC15	DC12	DC13	DC14	AC12	AC15	DC12	DC14	
Operational current (A)	24 V AC/DC	5	5	5	2.5	1	5	3	5	1
	48 V AC/DC	5	5	2.5	1.2	0.2	5	3	2.5	0.2
	110 V AC/DC	5	5	0.6	0.35	0.05	5	2.5	0.6	0.05
	220/240 V AC	5	4	-	-	-	5	2	-	-
	250 V DC	-	-	0.3	0.03	0.03	5	-	0.3	0.03
	380/440 V AC	5	2	-	-	-	5	1.5	-	-
	480 V AC	5	1.5	-	-	-	5	1	-	-
660/690 V AC	5	0.1	-	-	-	-	-	-	-	

Wireless Indication Auxiliary

The Wireless Indication Auxiliary communicates via IEEE802.15.4 to a gateway and can be mounted on OF, SD or SDE slots.

It does not require any wiring, but does contain a battery.

ComPacT NSX:

- Battery lifetime: 10 years

For more information on the **Wireless Indication Auxiliary**, refer to the instruction sheet **NNZ8882801**.



Customize Circuit Breakers with Accessories

ComPacT NSX Accessories and Auxiliaries

SDx and SDTAM

SDx Module

The SDx module remotes the trip or alarm conditions of ComPacT NSX circuit breakers equipped with electronic protection. The SD2 output, available on all MicroLogic trip units, corresponds to the overload-trip indication.

The SD4 output, available on MicroLogic 5/6/7, is assigned to:

- MicroLogic 5: overload (Ir)
- MicroLogic 6: overload (Ir) and ground fault (Ig)
- MicroLogic Vigi 7E: overload (Ir) and earth leakage fault (IΔn).

These two outputs automatically reset when the device is closed (turned ON).

For MicroLogic 5/6/7, the SD2 and SD4 outputs can be reprogrammed to be assigned to other types of tripping or alarm.

Output characteristics

It is possible to assign a function:

- Latching with a time delay. Return to the initial state occurs at the end of the time delay
- Permanent latching. In this case, return to the initial state takes place via the communication function.

Static outputs: 24 to 415 V AC/V DC; 80 mA max.

SDTAM Module

The SDTAM module is specifically for the motor-protection MicroLogic trip units 2.2 M, 2.3 M and 6.2 E-M, 6.3 E-M.

The SDTAM module, linked to the contactor controller, opens the contactor when an overload or other motor fault occurs, thus avoiding opening of the circuit breaker.

MicroLogic 2 M

The SD4 output opens the contactor 400 ms before normal circuit-breaker opening in the following cases:

- Overload (long-time protection for the trip class)
- Phase unbalance or phase loss.

The SD2 output serves to memorize contactor opening by SDTAM.

MicroLogic 6 E-M

The SD4 output opens the contactor 400 ms before normal circuit-breaker opening in the following cases:

- Overload (long-time protection for the trip class)
- Phase unbalance or phase loss
- Locked rotor
- Underload (undercurrent protection)
- Long start.

The SD2 output serves to memorize contactor opening by SDTAM.

Output characteristics

Output reset can be:

- Manual by a pushbutton included in the wiring diagram
- Automatic after an adjustable time delay (1 to 15 minutes) to take into account the motor-cooling time.

Static outputs: 24 to 415 V AC/V DC; 80 mA max.

SDx and SDTAM are relay modules with two static outputs. They send different signals depending on the type of fault. They may not be used together.



SDx relay module with its terminal block

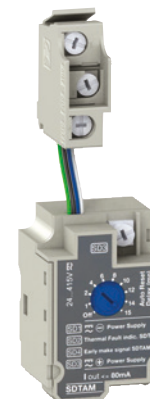

SDTAM relay module with its terminal block

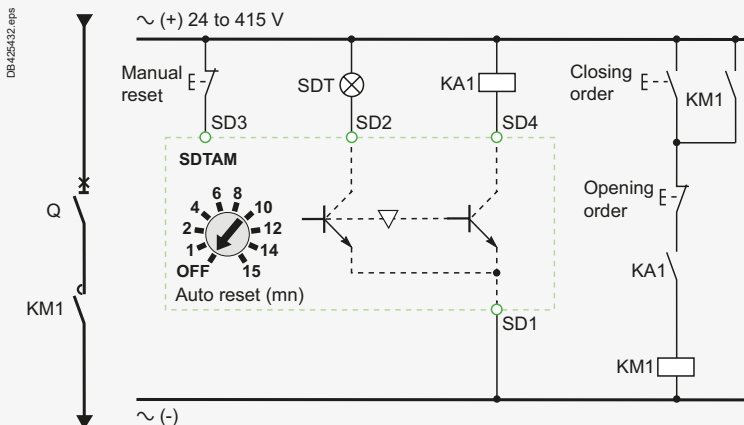

SDTAM wiring diagram with contactor control

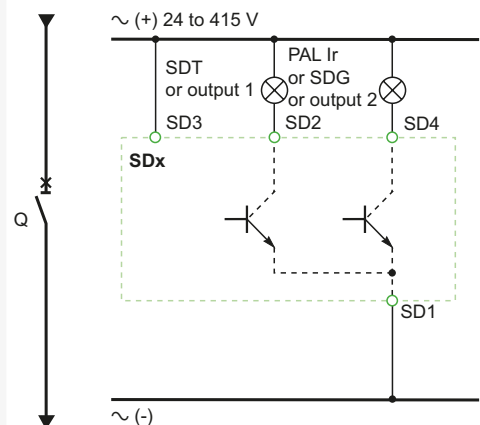

SDx wiring diagram

ComPacT NSX Accessories and Auxiliaries

Motor Mechanism



ComPacT NSX250 with motor mechanism

When equipped with a **motor-mechanism** module, ComPacT NSX circuit breakers feature very high mechanical endurance as well as easy and reliable operation:

- All circuit-breaker indications and information remain visible and accessible, including trip-unit settings and indications.
- Suitability for isolation is maintained and padlocking remains possible.
- Double insulation of the front face.

A specific motor mechanism is required for operation via the communication function. This **communicating motor mechanism** must be connected to the BSCM Modbus SL/ULP module to receive the opening and closing orders. Operation is identical to that of a standard motor mechanism.

Applications

- Local motor-driven operation, Centralized operation, automatic distribution control.
- Normal/standby source changeover or switching to a replacement source for availability and energy cost optimization.
- Load shedding and reconnection.
- Synchrocoupling.

Operation

The type of operation is selected using the manual/auto mode selection switch (7). A transparent, lead-seal cover controls access to the switch.

Automatic

When the switch is in the "auto" position, the ON (I) button and the charging lever on the mechanism are locked. **OFF (O) button may be used for tripping.**

Circuit-breaker ON and OFF controlled by two impulse-type or maintained signals.

Additionally, OFF (O) button is accessible in Automatic operating mode for emergency tripping.

Automatic spring charging following voluntary tripping (by MN or MX), with standard wiring.

Mandatory manual reset following tripping due to an electrical fault.

Manual

When the switch is in the "manual" position, the ON/OFF (I/O) buttons may be used.

A microswitch linked to the manual position can remote the information.

- Circuit-breaker ON and OFF controlled by 2 pushbuttons I/O.
- Recharging of stored-energy system by pumping the lever 8 times.
- Padlocking in OFF position.

Installation and Connections

All installation (fixed, plug-in/withdrawable) and connection possibilities are maintained.

Motor-mechanism module connections are made behind its front cover to integrated terminals, for cables up to 2.5 mm².

Optional Accessories

- Keylock for locking in OFF position.
- Operations counter for the ComPacT NSX400/630, indicating the number of ON/OFF cycles. Must be installed on the front of the motor-mechanism module.

Characteristics

Motor mechanism		MT100 to MT630	
Response time (ms)	opening	< 700	
	closing	< 80	
Operating frequency	cycles/minute max.	4 [2]	
Control voltage (V)	DC	24/30 - 48/60 - 110/130 - 250	
	AC 50/60 Hz	48 (50 Hz) - 110/130 - 220/240 - 380/440	
Consumption [1]	DC (W)	opening	≤ 500
		closing	≤ 500
	AC (VA)	opening	≤ 500
		closing	≤ 500

[1] For NSX100 to NSX250, the inrush current is 2 In for 10 ms.

[2] For MT250/MTc250 DC Range, operation frequency is 2 cycles/minute max.

Electrical Endurance

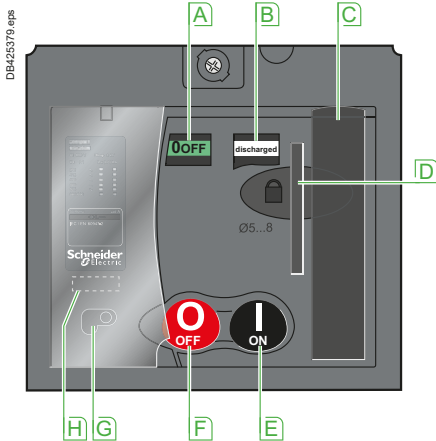
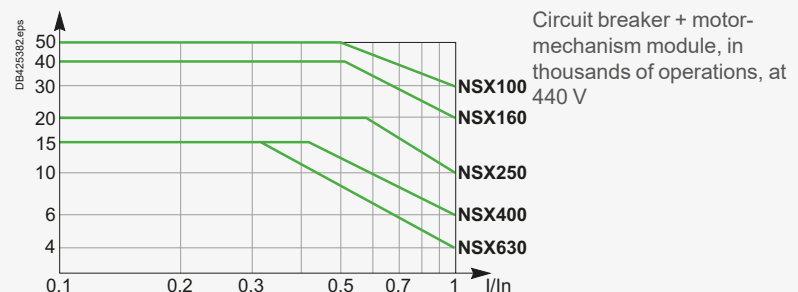

- A** Position indicator (positive contact indication)
- B** Spring status indicator (charged, discharged)
- C** Manual spring-charging lever
- D** Keylock device (optional)
Locking device (OFF position), using 1 to 3 padlocks, shackle diameter 5 to 8 mm, not supplied
- E** I (ON) pushbutton
- F** O (OFF) pushbutton
- G** Manual/auto mode selection switch The position of this switch can be indicated remotely
- H** Operation counter (ComPacT NSX400/630)

Customize Circuit Breakers with Accessories

ComPacT NSX Accessories and Auxiliaries

Remote Tripping

MX or MN voltage releases are used to trip the circuit breaker. They serve primarily for remote, emergency-off commands. It is advised to test the system every six months. Terminals are spring type in order to ensure a fast and reliable connection.

MN Undervoltage Release

The MN release opens the circuit breaker when its supply voltage drops to a value below 35 % of its rated voltage U_n .

Undervoltage tripping, combined with an emergency-off button, provides fail-safe tripping. The MN release is continuously supplied, i.e. if supply is interrupted:

- Either voluntarily, by the emergency-off button
- Or accidentally, through loss of power or faulty wiring. the release provokes opening of the circuit breaker.

Opening conditions

Circuit-breaker tripping by an MN release meets the requirements of standard IEC 60947-2.

- Automatic opening of the circuit breaker is ensured when the continuous voltage supply to the release $U \leq 0.35 \times U_n$.
- If the supply voltage is between 0.35 and 0.7 U_n , opening is possible, but not guaranteed. Above 0.7 U_n , opening does not take place.

Closing conditions

If there is no supply to the MN release, it is impossible to close the circuit breaker, either manually or electrically. Closing is ensured when the voltage supply to the release $U \geq 0.85 \times U_n$. Below this threshold, closing is not ensured.

Characteristics

Power supply	V AC	50/60 Hz: 24 - 48 - 100/130 - 200/240 50 Hz: 380/415 60 Hz: 208/277
	V DC	12 - 24 - 30 - 48 - 60 - 125 -250
Operating threshold	Opening	0.35 to 0.7 U_n
	Closing	0.85 U_n
Operating range		0.85 to 1.1 U_n
Consumption (VA or W)		Pick-up: 10 - Hold: 5
Response time (ms)		50

Time-delay unit for an MN release

A time delay unit for the MN release eliminates the risk of nuisance tripping due to a transient voltage dip. For shorter micro-outages, a system of capacitors provides temporary supply to the MN at $U > 0.7$ to ensure non tripping. The correspondence between MN releases and time-delay units is shown below.

Power supply	Corresponding MN release
Unit with fixed delay 200 ms	
48 V AC	48 V DC
220/240 V AC	250 V DC
Unit with adjustable delay ≥ 200 ms	
48 - 60 V AC/DC	48 V DC
100 - 130 V AC/DC	125 V DC
220 - 250 V AC/DC	250 V DC

MX Shunt Release

The MX release opens the circuit breaker via an impulse-type (≥ 20 ms) or maintained order.

Opening conditions

When the MX release is supplied, it automatically opens the circuit breaker. Opening is ensured for a voltage $U \geq 0.7 \times U_n$.

Characteristics

Power supply	V AC	50/60 Hz: 24 - 48 - 100/130 - 200/240 50 Hz: 380/415 60 Hz: 208/277
	V DC	12 - 24 - 30 - 48 - 60 - 125 -250
Operating range		0.7 to 1.1 U_n
Consumption (VA or W)		Pick-up: 10
Response time (ms)		50

Circuit Breaker Control by MN or MX

When the circuit breaker has been tripped by an MN or MX release, it must be reset before it can be reclosed.

MN or MX tripping takes priority over manual closing.

In the presence of a standing trip order, closing of the contacts, even temporary, is not possible.

Connection using wires up to 1.5 mm² to integrated terminal blocks with screwless connections.



MX or MN voltage release

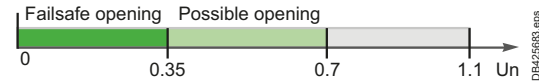

Opening conditions of the MN release



Closing conditions of the MN release

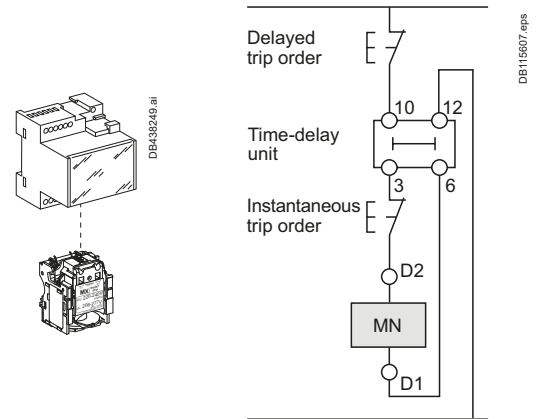

MN release with a time-delay unit

Wiring diagram for emergency-off function with MN + time-delay unit

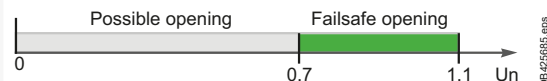

Opening conditions of the MX release

Note: Circuit breaker opening using an MN or MX release must be reserved for safety functions. This type of tripping increases wear on the opening mechanism. Repeated use reduces the mechanical endurance of the circuit breaker by 50 %.

ComPacT NSX Accessories and Auxiliaries

Rotary Handles

There are two types of rotary handle:

- Direct rotary handle
- Extended rotary handle.

There are two models:

- Standard with a black handle
- Red handle and yellow front for machine-tool control.



ComPacT NSX with a rotary handle



ComPacT NSX with an MCC rotary handle



ComPacT NSX with a CNOMO machine-tool rotary handle



ComPacT NSX with an extended rotary handle installed at the back of a switchboard, with the keylock option and key

Direct Rotary Handle

Standard Handle

Degree of protection IP40, IK07.

The direct rotary handle maintains:

- Visibility of and access to trip-unit settings
- Suitability for isolation
- Indication of the three positions O (OFF), I (ON) and tripped
- Access to the "push to trip" button.

Device locking

The rotary handle facilitates circuit-breaker locking.

- Padlocking:
 - Standard situation, in the OFF position, using 1 to 3 padlocks, shackle diameter 5 to 8 mm, not supplied.
 - With a simple modification, in the ON and OFF positions. Locking in the ON position does not prevent free circuit-breaker from tripping if a fault occurs. In this case, the handle remains the ON position after the circuit breaker tripping. Unlocking is required to go to the tripped then the OFF position.
- Keylock (and padlock).

It is possible to install a Ronis or Profalux keylock (optional) on the base of the handle to obtain the same functions as with a padlock.

Early-make or early-break contacts (optional)

Early-make and/or early-break contacts may be used with the rotary handle. It is thus possible to:

- Supply an MN undervoltage release before the circuit breaker closes
- Open the contactor control circuit before the circuit breaker opens.

MCC Switchboard Control

Control of an MCC switchboard is achieved by adding a kit to the standard handle. In addition to the standard functions, the kit offers the characteristics listed below.

Higher degree of protection IP

Degree of protection IP43, IK07.

The IP is increased by a built-in gasket.

Door locking depending on device position

- The door cannot be opened if the circuit breaker is ON or in the tripped position. For exceptional situations, door locking can be temporarily disabled with a tool to open the door when the circuit breaker is closed.
- Circuit-breaker closing is disabled if the door is open. This function can be deactivated.

Machine-Tool Control in Compliance with CNOMO

Control of a machine-tool is achieved by adding a kit to the standard handle. In addition to the standard functions, the kit offers the characteristics listed below.

Enhanced waterproofness and mechanical protection

- Degree of protection IP54, IK08.
- Compliance with CNOMO E03.81.501N.

Extended Rotary Handle

Degree of protection IP55, IK08.

The extended rotary handle makes it possible to operate circuit breakers installed at the back of switchboards, from the switchboard front.

It maintains:

- Visibility of and access to trip-unit settings
- Suitability for isolation
- Indication of the three positions O (OFF), I (ON) and tripped.

Mechanical door locking when device closed

A standard feature of the extended rotary handle is a locking function, built into the shaft, that disables door opening when the circuit breaker is in the ON or tripped positions.

Door locking can be temporarily disabled with a tool to open the door without opening the circuit breaker. This operation is not possible if the handle is locked by a padlock.

Voluntary disabling of mechanical door locking

A modification to the handle, that can be carried out on site, completely disables door locking, including when a padlock is installed on the handle. The modification is reversible.

When a number of extended rotary handles are installed on a door, this disabling function is the means to ensure door locking by a single device.

Customize Circuit Breakers with Accessories

ComPacT NSX Accessories and Auxiliaries

Rotary Handles

Extended Rotary Handle (Cont.)

Operation when door is opened

An open door shaft operator can be used to operate the circuit breaker when door is opened. This accessory complies with UL 60947-4-1.

The indication of the three positions OFF (O), ON (I) and tripped (Trip) is visible on the circuit breaker.

Device and door padlocking

Padlocking locks the circuit-breaker handle and disables door opening:

- Standard situation, in the OFF position, using 1 to 3 padlocks, shackle diameter 5 to 8 mm, not supplied.
- With a simple modification, in the ON and OFF positions. Locking in the ON position does not prevent free circuit-breaker tripping if a fault occurs.

In this case, the handle remains in the ON position after the circuit breaker tripping. Unlocking is required to go to the tripped then the OFF position.

If the door controls were modified to voluntarily disable door locking, padlocking does not lock the door, but does disable handle operation of the device.

Device locking using a keylock inside the switchboard

It is possible to install a Ronis or Profalux keylock (optional) on the base of the rotary handle to lock the device in the OFF position or in either the ON or OFF positions.

Accessory for device operation with the door open

When the device is equipped with an extended rotary handle, a control accessory mounted on the shaft makes it possible to operate the device with the door open.

- The device can be padlocked in the OFF position.
- The accessory complies with UL 60947-4-1.

Early-make or early-break contacts (optional)

The extended rotary handle offers the same possibilities with early-make and/or early-break contacts as the standard rotary handle.

Parts of the extended rotary handles

- A unit that replaces the front cover of the circuit breaker (secured by screws).
- An assembly (handle and front plate) on the door that is always secured in the same position, whether the circuit breaker is installed vertically or horizontally.
- An extension shaft that must be adjusted to the distance. The min/max distance between the back of circuit breaker and door is:
 - 185...600 mm for ComPacT NSX100 to 250
 - 209...600 mm for ComPacT NSX400/630.

For withdrawable devices, the extended rotary handle is also available with a telescopic shaft to compensate for device disconnection. In this case, the min/max distances are:

- 248...600 mm for ComPacT NSX100 to 250
- 272...600 mm for ComPacT NSX400/630.

Manual Source-Changeover Systems

An additional accessory interlocks two devices with rotary handles to create a source-changeover system. Closing of one device is possible only if the second is open.

This function is compatible with direct or extended rotary handles.

Up to three padlocks can be used to lock in the OFF or ON position.



ComPacT NSX Accessories and Auxiliaries

Manual and Automatic Transfer Switch

Schneider Electric offers source change-over systems based on ComPacT and MasterPact devices. They are made of up to 3 circuit breakers or switch-disconnectors linked by an electrical interlocking system that may have different configurations. Moreover, a mechanical interlocking system must be added to protect against electrical malfunctions or incorrect manual operations. In addition, a controller can be used for automatically control the source transfer. The following pages present the different solutions for mechanical and electrical interlocking and associated controllers.

M

Manual source-changeover system (or MTSE: Manual Transfer Switching Equipment)

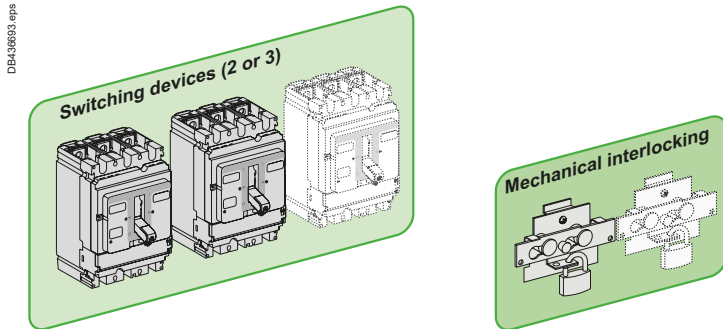

R/A

Remote-operated source-changeover system (or RTSE: Remote Transfer Switching Equipment)

Automatic source-changeover system (or ATSE: Automatic Transfer Switching Equipment)

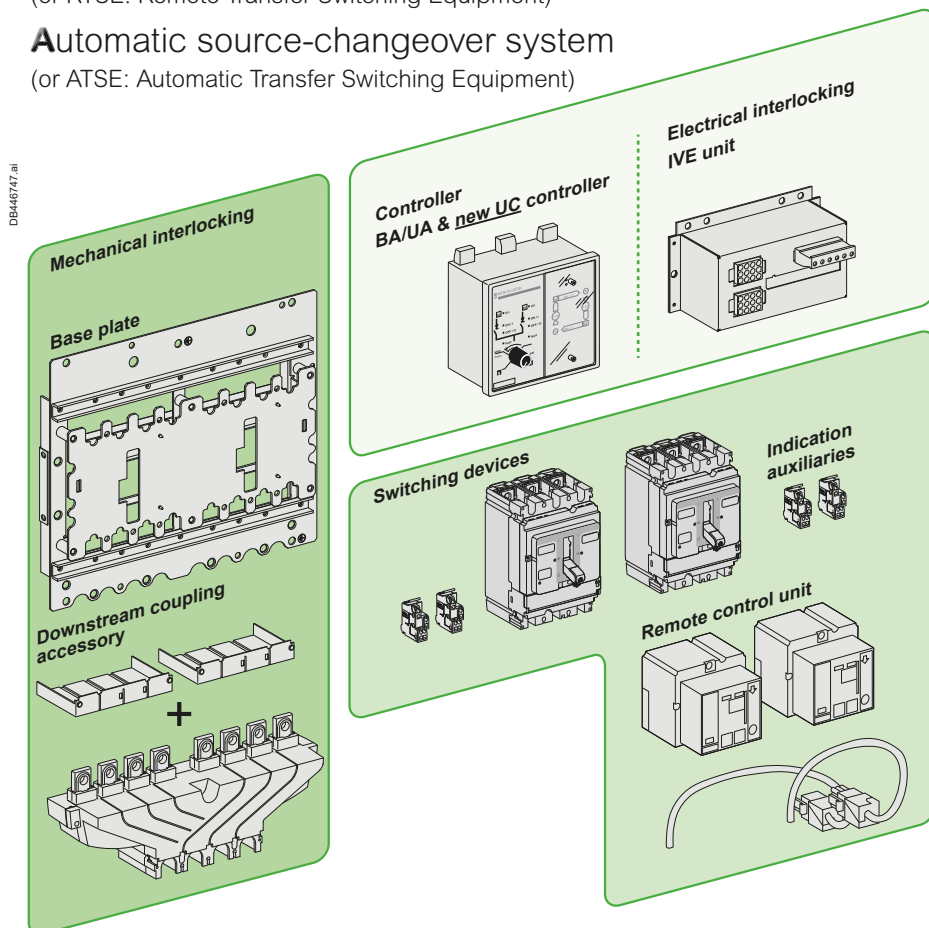

Customize Circuit Breakers with Accessories

ComPacT NSX Accessories and Auxiliaries

Mechanical Interlocking

Interlocking of Two or Three Toggle-Controlled Devices

Interlocking system

Two devices can be interlocked using this system. Two identical interlocking systems can be used to interlock three devices installed side by side.

Authorized positions:

- One device closed (ON), the others open (OFF)
- All devices open (OFF).

The system is locked using one or two padlocks (shackle Ø5 to 8 mm).

This system can be expanded to more than three devices.

There are two interlocking-system models:

- One for ComPacT INS/INV
- One for ComPacT NSX100 to NSX250
- One for ComPacT NSX400 to NSX630.

Combinations of Normal and Replacement devices

All toggle-controlled fixed or plug-in ComPacT NSX100 to NSX630 circuit breakers and switch-disconnectors of the same frame size can be interlocked. The devices must be either all fixed or all plug-in versions.

Interlocking of Two Devices by Rotary Handles

Interlocking system

Interlocking involves padlocking the direct and extended rotary handles on two devices which may be either circuit breakers or switch-disconnectors.

Authorized positions:

- One device closed (ON), the other open (OFF)
- Both devices open (OFF).

The system is locked using up to three padlocks (shackle Ø5 to 8 mm).

There are two interlocking-system models:

- One for ComPacT INS/INV
- One for ComPacT NSX100 to NSX250
- One for ComPacT NSX400 to NSX630.

Combinations of Normal and Replacement devices

All rotary-handle fixed or plug-in ComPacT NSX100 to NSX630 circuit breakers and switch-disconnectors of the same frame size can be interlocked. The devices must be either all fixed or all plug-in versions.

Interlocking of Two Devices by Base Plate

Interlocking system

A base plate designed for two ComPacT NSX devices can be installed horizontally or vertically on a mounting rail. Interlocking is carried out on the base plate by a mechanism located behind the devices. In this way, access to the device controls and trip units is not blocked.

Combinations of Normal and Replacement devices

All rotary-handle and toggle-controlled ComPacT NSX100 to NSX630 circuit breakers and switch-disconnectors can be interlocked. Devices must be either all fixed or all plug-in versions, with or without earth-leakage protection or measurement modules.

An adaptation kit is required to interlock:

- Two plug-in devices
- A ComPacT NSX100 to NSX250 with an NSX400 to NSX630.

Connection to the downstream installation can be made easier using a coupling accessory.

Interlocking of Devices by Keylocks (Captive Keys)

Interlocking using keylocks is very simple and makes it possible to interlock two or more devices that are physically distant or that have very different characteristics, for example medium-voltage and low-voltage devices or a ComPacT NSX100 to NSX630 switch-disconnector and circuit breaker.

Interlocking system

Each device is equipped with an identical keylock and the key is captive on the closed (ON) device. A single key is available for all devices. It is necessary to first open (OFF position) the device with the key before the key can be withdrawn and used to close another device.

A system of wall-mounted captive key boxes makes a large number of combinations possible between many devices.

Combinations of Normal and Replacement devices

All rotary-handle ComPacT NSX100 to NSX630 circuit breakers and switch-disconnectors can be interlocked between each other or with any other device equipped with the same type of keylock.



Interlocking of two or three toggle-controlled devices



Interlocking of two devices by rotary handles



Interlocking on a base plate

> TransferPacT
(Source-changeover systems)



LVPED216028EN



ComPacT NSX Accessories and Auxiliaries

Mechanical and Electrical Interlocking for Source-Changeover Systems

PB113419.eps



Remote-operated source-changeover system

- A** Circuit breaker QS1 equipped with a motor mechanism and auxiliary contacts, connected to the N source
- B** Circuit breaker QS2 equipped with a motor mechanism and auxiliary contacts, connected to the R source
- C** Base plate with mechanical interlocking
- D** Electrical interlocking unit IVE
- E** Coupling accessory (downstream connection)

DB41733.eps

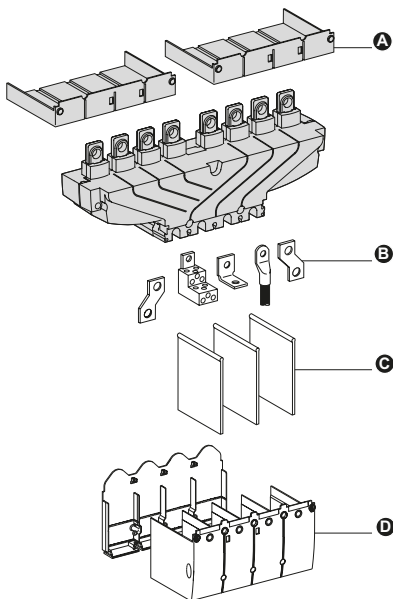

- A** Short terminal shields
- B** Terminals
- C** Interphase barriers
- D** Long terminal shields

It is made up of two devices with motor mechanisms, mounted on a base plate and combined with:

- An electrical interlocking unit
- Optional mechanical interlocking system.

Electrical interlocking unit (IVE)

Interlocks two devices equipped with motor mechanisms and auxiliary contacts. The IVE unit is mandatory to ensure the necessary time-delays required for safe switching.

Mechanical interlocking system

The mechanical interlocking system is strongly recommended to limit the effects of design or wiring errors and to avoid manual switching errors.

DB423006.ai

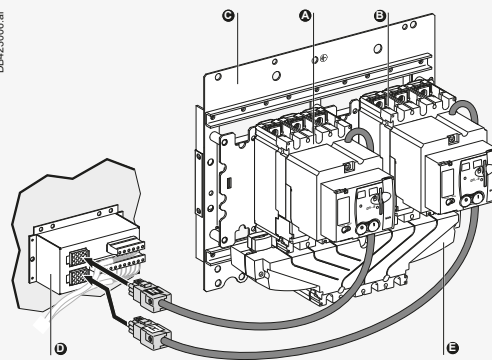

Downstream Coupling Accessory

This accessory simplifies connection to bars and cables with lugs. It may be used to couple two circuit breakers of the same size.

Pitch between outgoing terminals:

- ComPacT NSX100 to NSX250: 35 mm
- ComPacT NSX400 to NSX630: 45 mm.

For ComPacT NSX circuit breakers, the downstream coupling accessory can be used only with **fixed versions**.

Connection and Insulation Accessories

The coupling accessory can be fitted with the same connection and insulation accessories as the circuit breakers.

Possible uses	Downstream coupling	
	Possible mounting	Outgoing pitch (mm)
Remote-operated source-changeover systems		
NSX100 to NSX250	●	35
NSX400 to NSX630	●	45

ComPacT NSX Accessories and Auxiliaries

Automatic Source-Changeover Systems with Controller

By combining a remote-operated source-changeover system with an integrated BA or UA automatic controller, it is possible to automatically control source transfer according to user-selected sequences. These controllers can be used on source-changeover systems comprising 2 circuit breakers. For source-changeover systems comprising 3 circuit breakers, the automatic control diagram must be prepared by the installer as a complement to diagrams provided in the “electrical diagrams” section of the catalog source-changeover systems.

Functions of the BA and UA Controllers



BA controller



UA controller



TransferPacT ACP control plate

Controller		BA	UA					
Compatible circuit breakers		ComPacT NSX100 to 630 circuit breakers						
4-position switch								
Automatic operation		<input checked="" type="radio"/>	<input checked="" type="radio"/>					
Forced operation on Normal source		<input checked="" type="radio"/>	<input checked="" type="radio"/>					
Forced operation on Replacement source		<input checked="" type="radio"/>	<input checked="" type="radio"/>					
Stop (both Normal and Replacement sources OFF)		<input checked="" type="radio"/>	<input checked="" type="radio"/>					
Automatic operation								
Monitoring of the Normal source and automatic transfer from one source to the other		<input checked="" type="radio"/>	<input checked="" type="radio"/>					
Engine generator set start-up control			<input checked="" type="radio"/>					
Delayed shutdown (adjustable) of engine generator set			<input checked="" type="radio"/>					
Load shedding and reconnection of non-priority loads			<input checked="" type="radio"/>					
Transfer to Replacement source if one of the Normal source phases is absent			<input checked="" type="radio"/>					
Test								
By opening the P25M circuit breaker upstream of the controller		<input checked="" type="radio"/>						
By pressing the test button on the front of the controller			<input checked="" type="radio"/>					
Indications								
Circuit-breaker status indication on the front of the controller: ON, OFF, fault trip		<input checked="" type="radio"/>	<input checked="" type="radio"/>					
Automatic-mode indication contact		<input checked="" type="radio"/>	<input checked="" type="radio"/>					
Other functions								
Selection of type of Normal source (single-phase or three-phase)			<input checked="" type="radio"/>					
Voluntary transfer to Replacement source		<input checked="" type="radio"/>	<input checked="" type="radio"/>					
Forced operation on Normal source if Replacement source is not operational			<input checked="" type="radio"/>					
Additional test contact (not part of controller)		<input checked="" type="radio"/>	<input checked="" type="radio"/>					
Transfer to Replacement source only if contact closed (e.g. for a UR frequency check)		<input checked="" type="radio"/>	<input checked="" type="radio"/>					
Setting of maximum start-up time for the Replacement-source			<input checked="" type="radio"/>					
Power supply								
Control voltages ^[1]	220 to 240 V 50/60 Hz	<input checked="" type="radio"/>	<input checked="" type="radio"/>					
	380 to 415 V 50/60 Hz	<input checked="" type="radio"/>	<input checked="" type="radio"/>					
	440 V 60 Hz	<input checked="" type="radio"/>	<input checked="" type="radio"/>					
Operating thresholds								
Undervoltage	0.35 Un ≤ voltage ≤ 0.7 Un	<input checked="" type="radio"/>	<input checked="" type="radio"/>					
Phase failure	0.5 Un ≤ voltage ≤ 0.7 Un		<input checked="" type="radio"/>					
Voltage presence	voltage ≥ 0.85 Un	<input checked="" type="radio"/>	<input checked="" type="radio"/>					
Characteristics of output contacts (dry, volt-free contacts)								
Rated thermal current (A)	8							
Minimum load	10 mA at 12 V							
		AC				DC		
		AC12	AC13	AC14	AC15	DC12	DC13	
Utilization category (IEC 60947-5-1)	Operational current (A)	24 V	8	7	5	6	8	2
		48 V	8	7	5	5	2	-
		110 V	8	6	4	4	0.6	-
		220/240 V	8	6	4	3	-	-
		250 V	-	-	-	-	0.4	-
		380/415 V	5	-	-	-	-	-
		440 V	4	-	-	-	-	-
660/690 V	-	-	-	-	-	-		

[1] The controller is powered by the ACP control plate. The same voltage must be used for the ACP plate, the IVE unit and the circuit-breaker operating mechanisms. If this voltage is the same as the source voltage, then the “Normal” and “Replacement” sources can be used directly for the power supply. If not, an isolation transformer must be used.



ComPacT NSX Accessories and Auxiliaries

Automatic Source-Changeover Systems with Controller

By combining a TransferPacT UC Controller with a TransferPacT UC Adaptor, it is possible to automatically control source transfer according to user-selected sequences. These controllers can be used on source-changeover systems comprising 2 circuit breakers.



UC controller.

Controller		UC
Compatible circuit breakers		All ComPact NS, ComPact NSX and MasterPacT circuit breakers
HMI Operation		
Automatic operation		●
Button operation to S1		●
Button operation to S2		●
Button operation to OFF (both S1 and S2 sources off)		●
Automatic operation		
Monitoring of the Normal source and automatic transfer		●
Transfer to the Normal source if one of the phases of the Replacement phase is absent		●
Neutral lost		●
Unbalance of three phase voltage		●
Phase failure		●
Phase rotation		●
Generator set startup control		○
Delayed shutdown (adjustable) of generator set		○
Load shedding and reconnection of non-priority circuits		○
Manual transfer test		
By opening the IC65H circuit breaker supplying the controller		●
By Front HMI Button		●
Indications		
Circuit breaker status indication on the front of the controller: on, off, trip		●
Automatic mode indication		●
Alarm indication		●
Other functions		
Voluntary transfer		○
Remote test		○
Transfer inhibit		○
Source status indication		○
Communication modbus RTU		○
Communication control		○
External power supply port (auxiliary supply)		○
Load shedding and Availability Warning		○
Pincode protection		●
Event log		●
Trip inhibit		●
Source priority		●
Wrong connection of neutral warning		●
Power supply		
Breaker Control voltages ^[1]	208 to 230 V 50/60 Hz ^[2]	●
	380 to 415 V 50/60Hz and 440 V 60Hz ^[3]	●
Operating thresholds		
Voltage lost	voltage ≤ 30 V	●
Undervoltage	0.7 Un ≤ voltage threshold ≤ 0.95 Un	●
Overvoltage	1.05 Un ≤ voltage threshold ≤ 1.35 Un	●
Under Frequency	0.8 Fn ≤ frequency threshold ≤ 0.98 Fn	●
Over Frequency	1.01 Fn ≤ frequency threshold ≤ 1.2 Fn	●
Unbalance of three phase voltage	2% to 30%	●
Controller		UC
IP degree of protection (EN 60529) and IK degree of protection against external mechanical impacts (EN 50102)		
Front	IP55	●
Side	IP30	●
Connectors	IP20	●
Front	IK07	●

Note: ● Standard ○ Optional

[1] Note: The controller is powered by the Adaptor. The voltage of the circuit breaker control auxiliaries that forms the ATS with the adapter should be consistent with the adapter voltage. Incorrect selection may result in product failure.

[2] Note: 2 references , one for 220 -240 VAC network (L-L), the other for 380-440VAC networks (L-L) with auxiliaries supplied from L-N voltage.

[3] Note: The voltage for use in 380-440VAC networks (L-L) with auxiliaries supplied from L-L voltage

ComPacT NSX Accessories and Auxiliaries

Additional Measurement Module: PowerLogic PowerTag Monoconnect 250 A and 630 A for NSX

PowerTag Energy M250/M630 is designed for Molded Case Circuit Breakers and Switches (ComPacT and TeSys) for 3P and 3P+N electrical networks. This PowerTag Energy is mounted directly on the bottom side of the circuit breaker or the Vigi add-on if any. Thanks to its integrated design, it does not require any specific wiring, and is compatible with the same connection accessories than the device it is mounted on.

Functions

PowerTag Energy M250/M630 measures the following values in accordance with the IEC 61557-12 standard PMD-II/DD/K70/1:

- Energy (4 quadrants):
 - Active energy (kWh): total and partial, delivered and received
 - Active energy per phase (kWh): total
 - Reactive energy (VARh): partial, delivered and received.
- Voltages (V): phase-to-phase (U12, U23, U31) and phase-to-neutral (V1N, V2N, V3N)
- Currents (A): per phase (I1, I2, I3)
- Power:
 - Active power (W): total and per phase
 - Reactive power (VAR): total.
 - Apparent power (VA): total.
- Frequency (Hz).
- Power factor.
- Voltage loss alarms:
 - PowerTag Energy sends a “voltage loss” alarm and the current-per-phase value before being de-energized.
 - At “voltage loss”, PowerTag Energy adds an overload alarm if the current is higher than the rated current of the associated protective device.

Installation

The module is self-powered and is installed for fixed devices directly on the bottom side of the circuit breaker or VigiPacT add-on terminals. For plug-in devices, it has to be installed on the base itself.

PowerTag Energy M250/M630 3P has to be used with 3P devices, and an external neutral voltage tap is provided in case of the installation has a neutral to provide phase-to-neutral voltages, active energy per phase and power per phase.

PowerTag Energy M250/M630 3P+N has to be used with 4P devices and with ComPacT INS/INV 3P/4P switches.

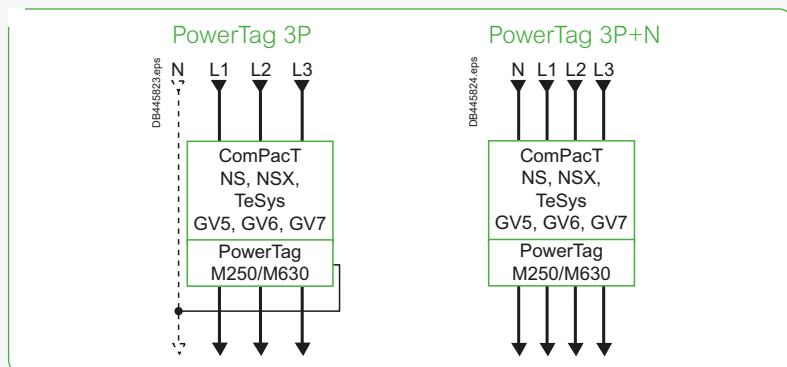

PowerTag M250/M630 modules are compatible with ComPacT NSX100/160/250, ComPacT NSX400/630, ComPacT INS250-100A to 250A, ComPacT INS320/400/500/630, ComPacT INV100/160/200/250, ComPacT INV320/400/500/630, ComPacT NS100/160/250 and ComPacT NS400/630.

In case of retrofit, following points have to be checked:

- Clearance to be able to add PowerTag module (see dimensions in chapter E) and to respect bending radius of cables.
- Condition of power connectors: to be replaced if damaged.
- Tightening torques depending of the connector used.



PowerLogic PowerTag Energy M250



ComPacT NSX Accessories and Auxiliaries

Additional Measurement Module: PowerLogic PowerTag

Monoconnect 250 A and 630 A for NSX

How to Monitor
PowerTag NSX
Sensors in FDM128
Local Display



Integration with Panel Server

For more information on the Panel Server, see "Wireless Communication Architectures With EcoStruxure Panel Server Design Guide" [DOCA0289EN-00](#).



Technical Specifications

Main characteristics			
Rated voltage	Un	Phase-to-neutral	230 VAC ± 20 %
		Phase-to-phase	400 VAC ± 20 %
Frequency			50/60 Hz
Maximum current	I _{max}		250 A/630 A
Maximum operating current			1.2 x I _{max}
Saturation current			2 x I _{max}
Maximum consumption			3.7 VA
Starting current	I _{st}		160 mA/400 mA
Basic current	I _b		40 A/100 A
Additional characteristics			
Operating temperature			-25 °C to +70 °C
Storage temperature			-50 °C to +85 °C
Overvoltage category		As per IEC 61010-1	Cat. IV
Measuring category		As per IEC 61010-2-030	Cat. III
Pollution degree			3
Altitude			Up to 2000 m without derating ^[1]
Degree of protection device			IP20 IK07
Radio-frequency communication			
ISM band 2.4 GHz			2.4 GHz to 2.4835 GHz
Channels		As per IEEE 802.15.4	11 to 26
Isotropic Radiated Power		Equivalent (EIRP)	0 dBm
Maximum transmission time			< 5 ms
Channel occupancy		For 1 device	Messages sent every 5 seconds
Characteristics of measuring functions			
Function	Symbol	Performance category as per IEC 61557-12	Measuring range (250 A/630 A)
		Class	
Total active power (Active power per phase)	P	1	88 W (29 W) to 416 kW/ 222 W (74 W) to 1048 kW
Total reactive power	Q _A	2	88 VAR to 416 kVAR/ 221 VAR to 1048 kVAR
Total apparent power	S _A	2	88 VA to 416 kVA/221 VA to 1048 kVA
Active energy: per phase, total, partial	E _a	1	0 to 281.10 ⁹ kWh
Partial reactive energy	E _{rA}	2	0 to 281.10 ⁹ kVARh
Phase current	I	1	160 mA to 500 A/400 mA to 1260 A
Voltages (Line to Line)	U	0.5	320 to 480 VAC
Power factor	PF _A	1	-1 to 1

[1] Above 2000 m, please consult Schneider Electric.



ComPacT NSX Accessories and Auxiliaries

Additional Measurement Module: PowerLogic PowerTag Monoconnect 250 A and 630 A for NSX

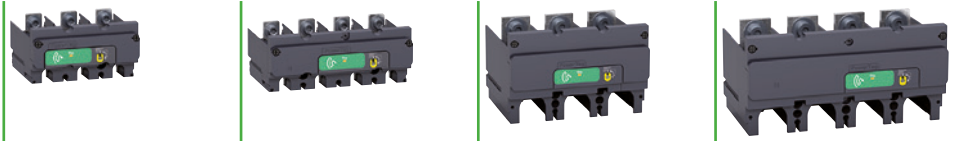

Products (AC network)	Mounting position	250 3P	250 3P+N	630 3P	630 3P+N
ComPacT					
Circuit breakers					
NSX100/160/250	3P	Bottom	☑	-	-
B/F/N/H/S/L/R Fixed	4P	Bottom	-	☑	-
NSX400/630	3P	Bottom	-	☑	-
F/N/H/S/L/R Fixed	4P	Bottom	-	-	☑
NSX100/160/250	3P	Top/Bottom	☑	-	-
B/F/N/H/S/L/R Plug-In (mounted on the base)	4P	Top/Bottom	-	☑ [1]	-
NSX400/630	3P	Top/Bottom	-	☑ [2]	-
F/N/H/S/L/R Plug-In (mounted on the base)	4P	Top/Bottom	-	-	☑ [1] [2]
NS100/160/250	3P	Bottom	☑	-	-
N/SX/H/L Fixed	4P	Bottom	-	☑	-
NS400/630	3P	Bottom	-	☑	-
N/H/L Fixed	4P	Bottom	-	-	☑
NS100/160/250	3P	Top/Bottom	☑	-	-
N/SX/H/L Plug-in (mounted on the base)	4P	Top/Bottom	-	☑ [1]	-
NS400/630	3P	Top/Bottom	-	☑ [2]	-
N/H/L Plug-in (mounted on the base)	4P	Top/Bottom	-	-	☑ [1] [2]
Circuit breakers equipped with Vigi block					
NSX100/160/250	3P	Bottom	☑	-	-
B/F/N/H/S/L/R Fixed	4P	Bottom	-	☑	-
NSX400/630	3P	Bottom	-	☑	-
F/N/H/S/L/R Fixed	4P	Bottom	-	-	☑
NSX100/160/250	3P	Top	☑	-	-
B/F/N/H/S/L/R Plug-In (mounted on the base)	3P	Top	-	☑ [2]	-
NSX400/630	3P	Top	-	☑ [2]	-
F/N/H/S/L/R Plug-In (mounted on the base)	3P	Top	-	☑ [2]	-
Switches					
INS250/INV - 100/160/200/250	3P	Bottom	-	☑	-
	4P	Top/Bottom	-	☑ [1]	-
INS/INV - 320/400/500/630	3P	Bottom	-	-	☑
	4P	Top/Bottom	-	-	☑ [1]

[1] Neutral on the right when mounted on top side

[2] When plate mounted, need to add an intercalary wedging plate under the PowerTag module with following dimensions:

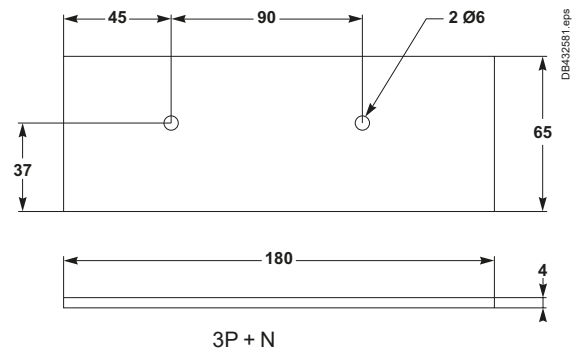
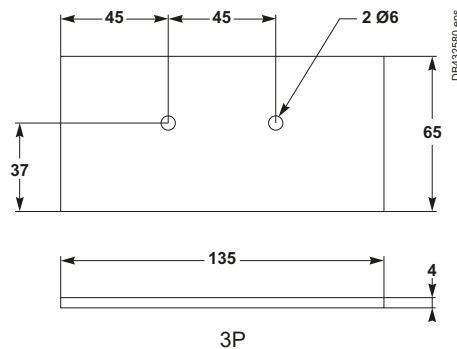

ComPacT NSXm Accessories and Auxiliaries

Additional Measurement Module: PowerLogic PowerTag Flex 160 A for NSXm

With its flex design this PowerTag Energy can be used on many products or group of loads up to 160 A on 3P or 3P+N networks. Its removable spring connector for voltage picking facilitates its installation, and shapes for brackets allows to mount and maintain it where needed in a panel.

AGMEM11950.eps



PowerTag Energy Flex 160 A



> PowerTag Energy

Main Characteristics

PowerTag Energy Flex 160 A measures the following values in accordance with the IEC 61557-12 standard PMD-II/DD/K70/1:

- Energy (4 quadrants):
 - Active energy (kWh): total and partial, delivered and received.
 - Active energy per phase (kWh): total and partial, delivered and received.
 - Reactive energy (kVARh): total and partial, delivered and received.
 - Reactive energy per phase (kVARh): total and partial, delivered and received.
 - Apparent energy (kVAh): total and partial.
 - Apparent energy per phase (kVAh): total and partial.

- Real-time measurement values:
 - Voltages (V): phase-to-phase (U12, U23, U31) and phase-to-neutral (V1N, V2N, V3N).
 - Currents (A): per phase (I1, I2, I3), calculated neutral current when connected (IN).
 - Power:
 - Active power (W): total and per phase.
 - Reactive power (VAR): total and per phase.
 - Apparent power (VA): total and per phase.
 - Frequency (Hz).
 - Power factor: total and per phase.

- Voltage loss alarms:
 - PowerTag Energy Flex sensor sends a “voltage loss” alarm and the current-per-phase value before being de-energized.
 - At “voltage loss”, PowerTag Energy Flex adds an overload alarm if the current is higher than the rated current of the associated protective device.

Note: Functions listed above depends on Concentrator/Gateway.

ComPacT NSXm Accessories and Auxiliaries

Additional Measurement Module: PowerLogic PowerTag Flex 160 A for NSXm

Technical Specifications

Main characteristics (as per IEC 61557-12)			
Rated voltage	Un	Phase-to-neutral Phase-to-phase	100...277 VAC ± 20 % 173...480 VAC ± 20 %
Frequency			50/60 Hz
Maximum current	I _{max}		160 A
Maximum operating current			1.2 x I _{max}
Saturation current			2 x I _{max}
Maximum consumption			3 VA
Starting current	I _{st}		100 mA
Basic current	I _b		25 A

Additional characteristics			
Operating temperature			-25 °C to +70 °C
Storage temperature			-40 °C to +85 °C
Overvoltage category		As per IEC 61010-1	Cat. IV
Measuring category		As per IEC 61010-2-030	Cat. IV
Pollution degree			3
Altitude			Up to 2000 m without derating ^[1]
Degree of protection device			IP20 IK05

Radio-frequency communication			
ISM band 2.4 GHz			2.4 GHz to 2.4835 GHz
Channels		As per IEEE 802.15.4	11 to 26
Isotropic Radiated Power		Equivalent (EIRP)	0 dBm
Maximum transmission time			< 5 ms
Channel occupancy		For 1 device	Messages sent every 5 seconds

Characteristics of measuring functions			
Function	Symbol	Performance category as per IEC 61557-12 (PMD-II/DD/K70/1)	Measuring range
		Class	
Total active power (Active power per phase)	P	1	24 W (8 W) to 192 kW
Total reactive power (Reactive power per phase)	Q _A	2	30 VAR (10 VAR) to 192 kVAR
Total apparent power (Apparent power per phase)	S _A	2	38 VA (13 VA) to 192 kVA
Active Energy: per phase, total, partial, delivered and received	E _a	1	0 to 281.109 kWh
Reactive energy: per phase, total, partial, delivered and received	E _{trA}	2	0 to 281.109 kVARh
Apparent energy: per phase, total, partial	E _{spA}	2	0 to 281.109 kVAh
Frequency	f	1	45 to 65 Hz
Phase current	I	1	100 mA to 320 A
Neutral current	I _{NC}	2	
Voltages (Line to Line)	U	0.5	138 to 576 VAC
Power factor (per phase, total)	P _{FA}	1	-1 to 1

[1] Above 2000 m, please consult us.



ComPacT NSX Accessories and Auxiliaries

Additional Measurement and Indication Modules

Current-Transformer Module with Voltage Measurement Outputs

This module enables direct connection of a digital measurement device such as a PowerLogic PM5000 series, PowerLogic PM8000 series etc. (not supplied).

Installation

- The module is installed directly on the downstream circuit-breaker terminals.
- Degree of protection IP40, IK04.
- Class II insulation between front and the power circuits.
- Built-in connectors for cables from 1.5 to 2.5 mm².

Electrical characteristics

- Insulation voltage $U_i = 690$ V.
- Rated operational voltage $U_e = 500$ V.
- Frequencies of measured values: 50...60 Hz.
- Three CTs with 5 A secondary windings for the rated primary current I_n :
 - Class 0.5 to 1 for rated power consumption values at the output:
 - 125 A, 150 A and 250 A ratings: Class 1 for 1 VA
 - 400/600 A rating: class 0.5 for 2 VA
 - Connection using a 2.5 mm² cable up to 2.5 m long.
- Four voltage measurement outputs including protection with automatic reset.
 - Voltage measurement output resistance $3500 \Omega \pm 25 \%$, maximum current 1 mA
 - The voltage measurement outputs are intended only for measurements (1 mA max.) and may not be used to supply the display.

Maintenance

The current transformer block has a lifetime of 20 years. It should be replaced after 20 years of use.

VigiPacT Add-on Alarm

This module detects and indicates an insulation drop on a load circuit (TN-S or TT systems).

Operation is identical to that of a VigiPacT add-on, but without circuit-breaker tripping.

Indication by a red LED in front.

An auxiliary contact may be installed for remote insulation-drop indications. When insulation drops below a minimum, user-set threshold, the LED goes on and the auxiliary contact switches. The fault indication cannot be cancelled except by pressing the manual reset button.

Installation

- The module is installed directly on the downstream circuit-breaker terminals.
- Degree of protection IP40, IK04.
- Double insulation of the front face.

Electrical characteristics

- Settings: 100 - 200 - 500 - 1000 mA.
- Accuracy: $-50 +0 \%$.
- Time delay following insulation drop: 5 to 10 seconds.
- AC-system voltage: 200 to 440 V AC.



ComPacT NSX with current-transformer module

PB105123_0_eps



VigiPacT add-on alarm

PB123301_L50_eps

Customize Circuit Breakers with Accessories

ComPacT NSX Accessories and Auxiliaries

Locks

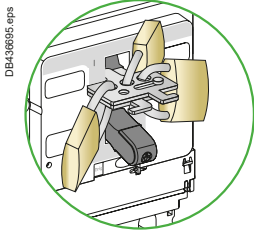

Toggle locking using padlocks and an accessory:
Removable device

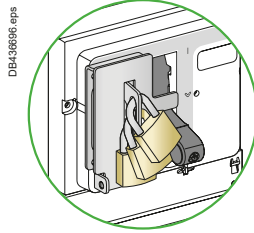

Fixed device attached to the case ^[3]

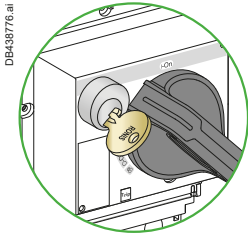

Rotary-handle locking using a keylock

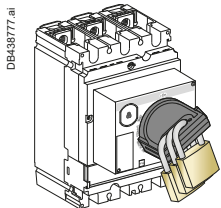

Rotary-handle locking using a padlock or a keylock

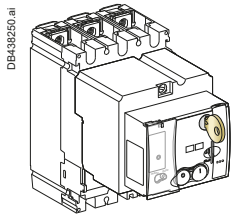
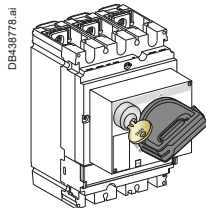

Motor-mechanism locking using a padlock or a keylock

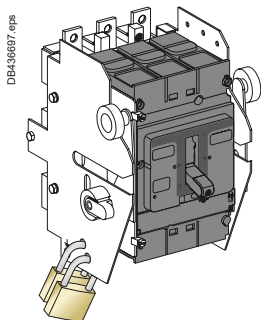
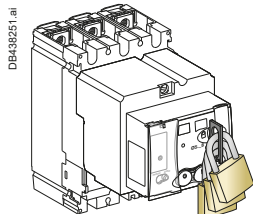

Chassis locking in the connected position

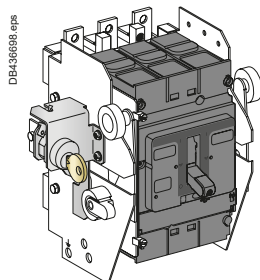

Locking in the OFF position guarantees isolation as per IEC 60947-2. Padlocking systems can receive up to three padlocks with shackle diameters ranging from 5 to 8 mm (padlocks not supplied). Certain locking systems require an additional accessory.

Important: For toggle locking with padlock accessories, using other accessories than the Schneider Electric recommended accessories may have an impact on the performance.

Control device	Function	Means	Required accessories	
Toggle	Lock in OFF position	Padlock	Removable device	
	Lock in OFF or ON position	Padlock	Fixed device	
Direct rotary handle	Standard	Lock in ■ OFF position	Padlock	
		■ OFF or ON position ^[1]	Keylock	
	MCC	Lock in ■ OFF position ■ OFF or ON position ^[1]	Padlock	-
Extended rotary handle	CNOMO	Lock in ■ OFF position ■ OFF or ON position ^[1]	Padlock	-
	Lock in ■ OFF position ■ OFF or ON position ^[1] with door opening prevented ^[2]	Padlock	-	
Lock in OFF position		Padlock	UL 60947-4-1 control accessory	
■ OFF or ON position ^[1] inside the switchboard		Keylock	Locking device + keylock	
Motor mechanism	Lock in OFF position remote operation disabled	Padlock	-	
		Keylock	Locking device + keylock	
Withdrawable circuit breaker	Lock in ■ disconnected position	Padlock	-	
		Keylock	Locking device + keylock	
	■ connected position	Keylock	Locking device + keylock	

[1] Following a simple modification of the mechanism.

[2] Unless door locking has been voluntarily disabled.

[3] Only for 3P-4P.



ComPacT NSX Accessories and Auxiliaries

Sealing Accessories

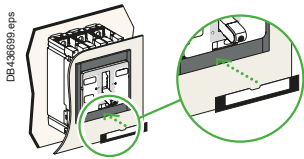

Identification accessories

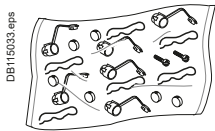

Sealing accessories

Outgoing-Circuit Identification

ComPacT NSX100 to 630 can be equipped with label holders supplied in sets of ten (cat. no. LV429226). They are compatible with escutcheons.

Sealing Accessories

Sealing accessories are available. Each bag of accessories contains all the parts required for the types of sealing indicated below.

A bag contains:

- 6 sealing accessories
- 6 lead seals
- 0.5 m of wire
- 2 screws.

Types of Seals and Corresponding Functions

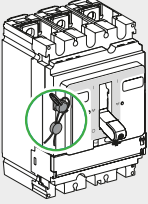
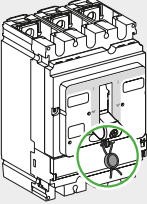
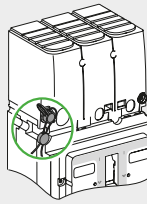
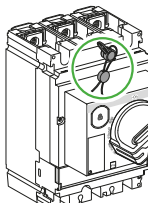
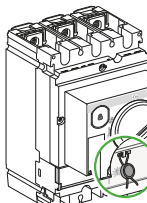
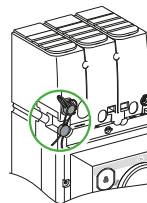
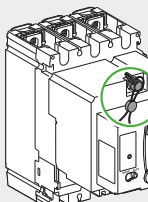
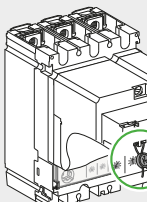
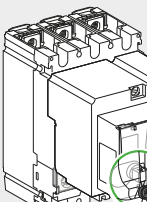
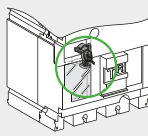
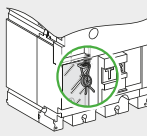
<p>Toggle control</p>			
<p>Rotary handle</p>			
<p>Motor mechanism</p>			
<p>Types of seals</p> <p>Protected operations</p>	<p>Front-cover fixing screw</p> <ul style="list-style-type: none"> ■ Front removal ■ Access to auxiliaries ■ Trip-unit removal. 	<p>Trip-unit transparent cover</p> <ul style="list-style-type: none"> ■ Modification of settings ■ Access to test connector. 	<p>Motor-mechanism transparent cover</p> <ul style="list-style-type: none"> ■ Access to manual/auto mode selection switch: depending on its position, manual ^[1] or automatic operation is not possible. <p>[1] In this case, local operation is not possible.</p>
<p>Access to VigiPacT add-on settings</p>			
<p>Types of seals</p> <p>Protected operations</p>	<p>VigiPacT add-on fixing device</p> <ul style="list-style-type: none"> ■ Removal of the VigiPacT add-on. 	<p>Protection cover for settings</p> <ul style="list-style-type: none"> ■ Modification of settings. 	

Customize Circuit Breakers with Accessories

ComPacT NSX Accessories and Auxiliaries

Escutcheons and Protection Collars

Escutcheons are an optional feature mounted on the switchboard door. They increase the degree of protection to IP40, IK07. Protection collars maintain the degree of protection, whatever the position of the device (connected, disconnected).



IP30 escutcheon



IP30 escutcheon with access to the trip unit

IP30 or IP40 Escutcheons for Fixed Devices

IP30

The three types are glued to the cut-out in the front door of the switchboard:

- Escutcheon for all control types (toggle, rotary handle or motor mechanism)
 - Without access to the trip unit
 - With access to the trip unit
- For VigiPacT add-on, can be combined with the above.

IP40

The four types, with a gasket, are screwed to the door cut-out:

- Three escutcheons identical to the previous, but IP40
- A wide model for Vigi modules that can be combined with the above.

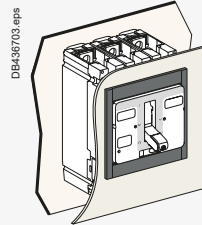

DE436703.eps

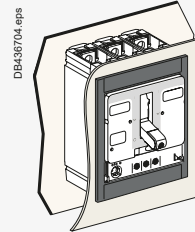

DE436704.eps

Escutcheon for toggle without and with access to the trip unit

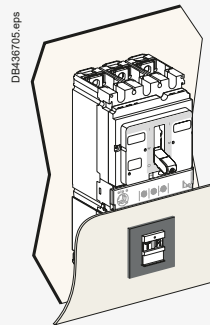

DE436705.eps

Escutcheon for VigiPacT add-on



ComPacT NSX Accessories and Auxiliaries

Escutcheons and Protection Collars

IP40 Escutcheons for Withdrawable Devices

IP40 for Withdrawable Devices

The two types, with a gasket, are screwed to the door cut-out:

- For rotary handle or motor mechanism: standard IP40 escutcheon
- For toggle with extension: standard escutcheon + collar for withdrawal.

DB438791.ai

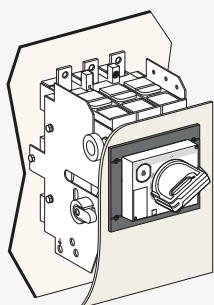

Standard escutcheon with rotary handle

DB112295.eps

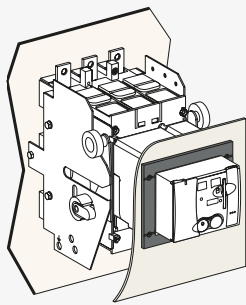

Standard escutcheon for motor mechanism

DB112296.eps

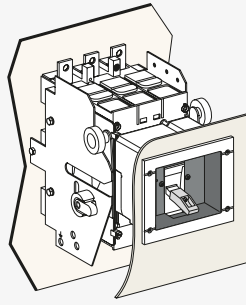

Standard escutcheon with collar for withdrawal, for toggle

IP40 for VigiPacT Add-on on Withdrawable Devices

The two types, with a gasket, are screwed to the door cut-out:

- For rotary handle or motor mechanism: standard IP40 escutcheon
- For toggle: standard escutcheon + collar for withdrawal.

DB438792.ai

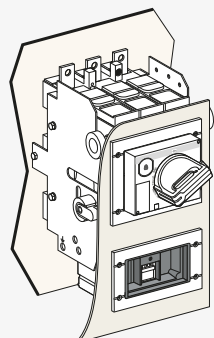

DB112298.eps

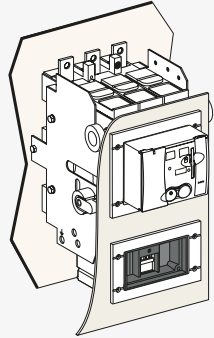

DB112299.eps

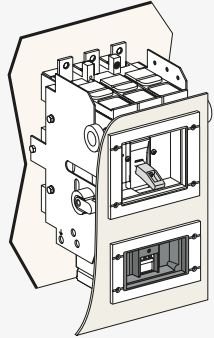

Escutcheon for VigiPacT add-on, with escutcheons for the three types of control

IP43 Toggle Cover

Available only for devices with toggles. Fits over toggle and front cover of the device.

- Mounted on the front of the circuit breaker.
- Degree of protection IP43, IK07.

DB112216.eps



Toggle cover

Retrofit Front Covers

These replacement front covers make it possible to install NSX devices in existing switchboards containing NS devices by installing the NS-type retrofit covers on the NSX devices.

- NS100 to 250 cover.
- NS400/630 cover.



Toggle cover



NS retrofit front cover

PE103775-40.eps

PE103820_35.eps

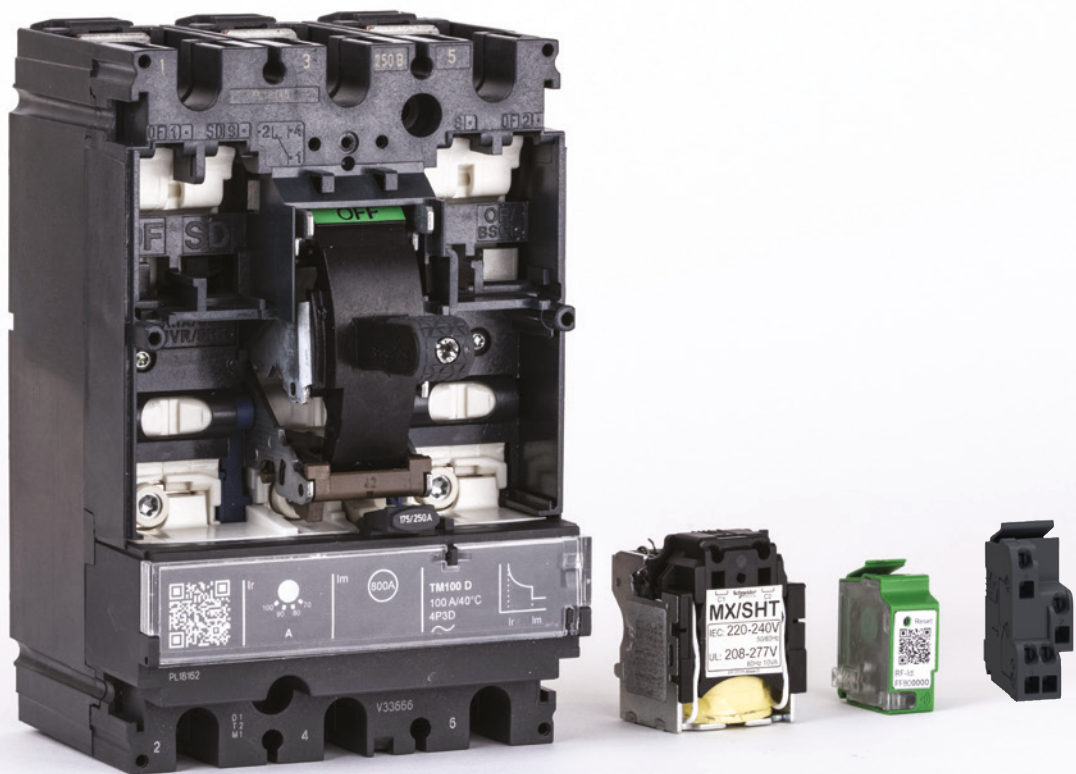

Smart Panel Integration

- Enerlin'X Functions**
 - Communication Wiring System..... D-2
 - Overview of Functions..... D-3
- Smart Panel**
 - Overview D-5
- Architecture Overview.....D-6**
- Enerlin'X Digital System**
 - Upgrade..... D-7
- Architecture Components**
 - FDM121 Display Unit D-8
 - FDM128 Display Unit D-10
- Customer Engineering Tool:**
 - EcoStruxure Power Commission Software D-12



Other Chapters	
Select Circuit Breakers and Switch-Disconnectors	A-1
Select Protection	B-1
Customize Circuit Breakers with Accessories.....	C-1
Switchboard Integration.....	E-1
Catalog Numbers	F-1
Glossary	G-1
Additional Characteristics.....	H-1



Get Circuit Breaker Status and Electrical Values Available Information and Functions

PB124126.ai



C25S8E250 eps

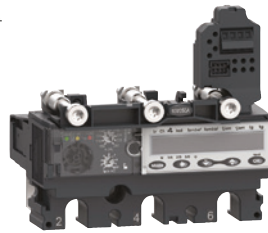

C25H4E250 eps



MicroLogic trip units for 3 poles, 4 poles ComPacT circuit breakers

ComPacT NSX MicroLogic E trip unit offers basic LSI protection (MicroLogic 5) or LSI and ground-fault protection G (MicroLogic 6), in addition to measurement, alarms, and communication functions.

MicroLogic E Functions

Measurements

- Instantaneous rms measurement
- Maximeter/minimeter
- Energy metering
- Power and current demand
- Power quality (voltage/current)

Operating Assistance

- Protection and alarm settings
- Histories
- Time stamped event tables
- Maintenance indicators

MicroLogic E Equipped with Motor Mechanism MTc

Controls

- Open
- Close

MicroLogic E Equipped with BSCM SL/ULP

Status Indications

- ON/OFF (O/F)
- Fault-trip SDE
- Connected/disconnected/test position CE/CD/CT
 (I/O module only connected to withdrawable kit)

All ComPacT circuit breakers may be equipped with a MicroLogic trip unit. This adjustable unit is mainly designed for tripping the circuit breaker in case of necessity and monitoring the downstream circuit. Alarms may be programmed for remote indications. Electrical measurements, operation data for predictive maintenance, are provided for local display or distant monitoring.

D

For Fixed Breakers

BSCM Modbus SL Mode Only

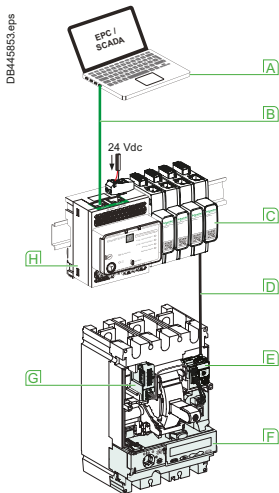

- A** Modbus TCP client
- B** Ethernet cable
- C** Modbus SL hub (LV434224)
- D** Modbus SL cord (LV434221, LV434222 or LV434223)
- E** BSCM Modbus SL/ULP module (LV434220)
- F** MicroLogic 5, 6 or 7 trip unit

BSCM ULP Mode Only

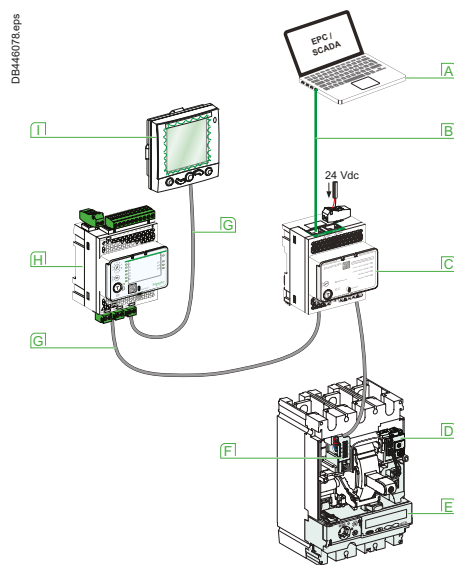

- A** Modbus TCP client
- B** Ethernet cable
- C** IFE Ethernet switchboard server (LV434002)
- D** BSCM Modbus SL/ULP module (LV434220)
- E** MicroLogic 5, 6 or 7 trip unit
- F** NSX cord (LV434200, LV434201, LV434202 or LV434203)
- G** ULP cord (LV434195, LV434196, LV434197 or LV434198)
- H** I/O module (LV434063)
- I** FDM121 display (TRV00121)

BSCM Modbus SL and ULP Mode

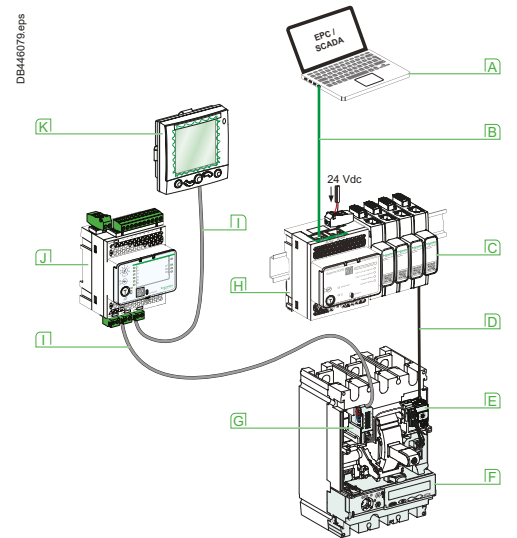

- A** Modbus TCP client
- B** Ethernet cable
- C** Modbus SL hub (LV434224)
- D** Modbus SL cord (LV434221, LV434222 or LV434223)
- E** BSCM Modbus SL/ULP module (LV434220)
- F** MicroLogic 5, 6 or 7 trip unit
- G** NSX cord (LV434200, LV434201, LV434202 or LV434203)
- H** IFE Ethernet switchboard server (LV434002)
- I** ULP cord (LV434195, LV434196, LV434197 or LV434198)
- J** I/O module (LV434063)
- K** FDM121 display (TRV00121)



Smart Panel Integration

Enerlin'X Functions

Overview of Functions

For Withdrawable Breakers

In order to keep the device address when changing a withdrawable circuit breaker, it is necessary to use an IFM or IFE linked to the device through ULP. The device must be equipped with an NSX Cord and a BSCM in ULP mode. Concerning the communication wiring, it is possible to use an automatic or manual auxiliary connector.

BSCM ULP Mode Only

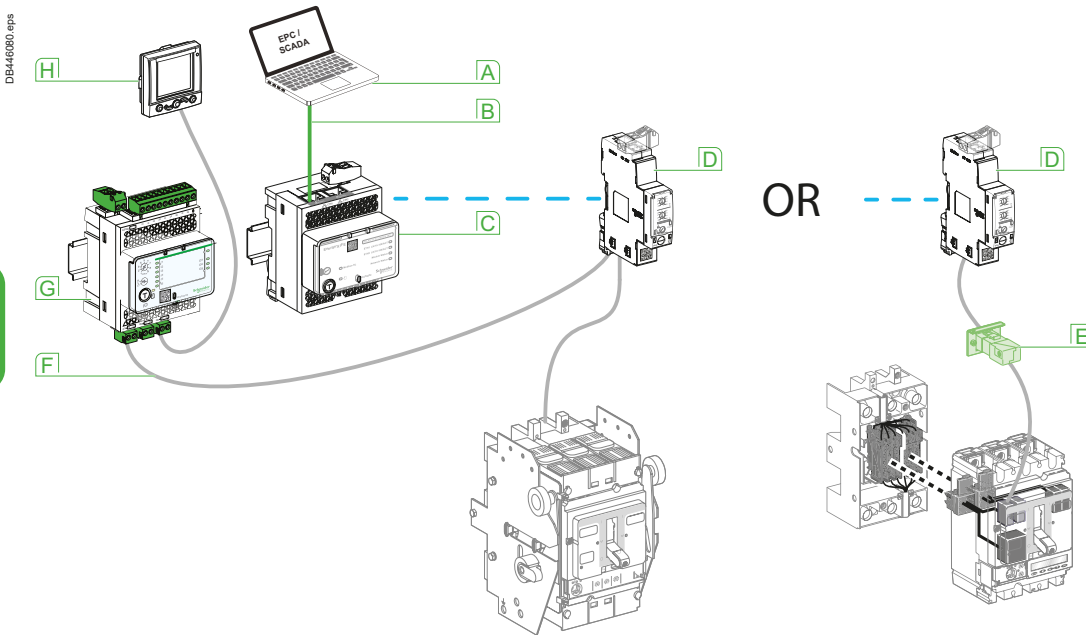

- A** Modbus TCP client
- B** Ethernet cable
- C** IFE Ethernet switchboard server (LV434002)
- D** IFM Modbus interface (LV434000)
- E** Manual auxiliary connector (LV429272)
- F** ULP cord (LV434195, LV434196, LV434197 or LV434198)
- G** I/O module (LV434063)
- H** FDM121 display (TRV00121)

Smart Panels can provide access to status, electrical values and devices control using wireless and/or wired communication.

There are several different ways to connect a panel.

DB44590.ai

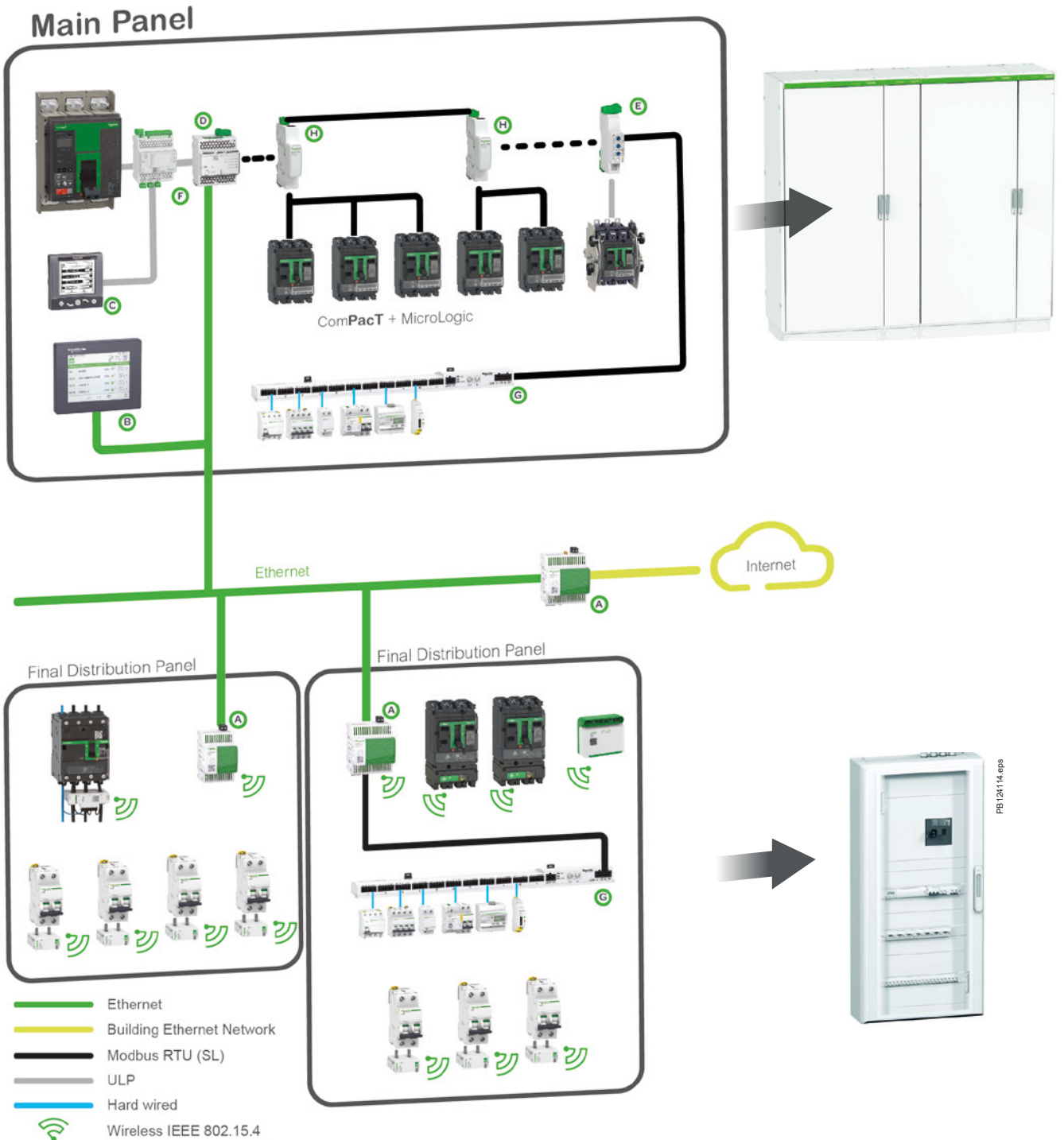

PB124113.eps

D

PB124114.eps

Note: Universal and Advanced PAS can also take in Modbus RTU.

Enerlin'X digital devices and displays									
	Name	Function	Protocol		Bin. Input	Analog. Input	Bin. Output	Comercial Reference	
			(to device)	(to server)					
A		Panel Server	Gateway	IEEE802.15.4	Modbus TCP/IP or Wi-Fi	-	-	-	PAS400
				Modbus SL, Modbus TCP/IP or IEEE802.15.4	Modbus TCP/IP or Wi-Fi	2 (PAS600L only)			PAS600L, PAS600
		Gateway and data logging	Modbus SL, Modbus TCP/IP or IEEE802.15.4	Modbus TCP/IP or Wi-Fi	2 (PAS800L only)	-	-	PAS800L, PAS800, PAS800P	
B		FDM128	Ethernet LCD color touch display	Modbus TCP/IP	-	-	-	LV434128	
C		FDM121	ULP LCD grey display	ULP	-	-	-	TRV00121	
D		IFE switchboard server	Ethernet interface and Gateway	ULP, Modbus SL or TCP/IP	Modbus TCP/IP	-	-	-	LV434002
E		IFM interface	Modbus interface for circuit breakers	ULP	Modbus SL	-	-	-	LV434000
F		I/O	Input/Output application module for circuit breaker	ULP	-	6	1	3	LV434063
G		I/O Smart Link	Modbus interface with Input/Output functions	-	Modbus RTU (SL)	22	-	11	A9XMSB11
H		Modbus SL Hub	Daisy chain ComPacT equipped with BSCM	Modbus SL	Modbus SL	3xModbus 0V;24V; -D;+D	1	3	LV434224

Ethernet Gateway or Interface: routes the internal traffic (ULP or other protocole) to the Internet: the outgoing messages are coded with Modbus TCP/IP protocol.

Server (Switchboard, Energy): routes the internal traffic to the Internet. Includes complementary functions such as data logging and storage. Provides device status and energy trends via internal web pages.

Note: For more information, see *ULP System for MasterPacT and ComPacT (IEC Standard) - User Guide* [DOCA0093EN](#) and *EcoStruxure Power for Commercial & Industrial Buildings - Smart Panels Assembly Guide* [ESXP1G003EN](#).

Communicating Accessories Selection Table

	Modbus SL mode				Modbus SL and ULP mode together	ULP mode ^[1]			
	Status indication only	Status indication				Status indication only	Status indication		Status indication
Type of information communicated									
	Control		Control			Control			Control
	Measurement					Measurement			
				Display					
Accessories									
BSCM Modbus SL/ULP	○ ^[2]	○ ^[2]	○ ^[2]	○ ^[2]	○	○	○		○
Com Modbus SL cord	○	○	○	○	○				
Modbus SL hub (mandatory for 24 V DC power supply of the trip unit and power supply of BSCM Modbus SL/ULP) ^[1]	○	○	○	○	○				
Indication auxiliary (LV434210)		○ ^[3]		○ ^[3]					
NSX Cord (ULP communication interface/24V DC power supply of TU and power supply of BSCM ULP / Indication auxiliary)					○ ^[4]	○ ^[4]	○ ^[4]	○ ^[4]	○ ^[4]
Communicating motor mechanism (delivered with a cable for connection to a BSCM)		○		○	○		○		○
Communicating Micrologic Trip Unit			○	○	○			○	○
FDM121/FDM128									
Compatibility									
Compatible for fix ComPacT NSX	○	○	○	○	○	○	○	○	○
Compatible with withdrawable ComPacT NSX						○	○	○ ^[5]	○
Compatible with non communicating motor mechanism								○	
Communication protocol out of the ComPacT NSX	Modbus SL	Modbus SL	Modbus SL	Modbus SL	Modbus SL ^[6]	ULP	ULP	ULP	ULP
IFM					○	○	○	○	○
IFE					○	○	○	○	○
IFE Gateway					○	○	○	○	○
Gateway	○	○	○	○	○	○	○	○	○

[1] Up to 4 Modbus SL hubs in daisy chain and up to 3 ComPacT NSX breakers per Modbus SL hub.
 [2] BSCM is located on OF/SDE slots, it retrieves information from the contacts.
 [3] Indication auxiliary is located on the SD slot, it retrieves information from the contact.
 [4] An insulated NSX Cord must be used for if U > 480 V.
 [5] Compatible as the SDE slot is available.
 [6] ULP communication between BSCM and FDM121/FDM128.



Architecture Components

FDM121 Display Unit

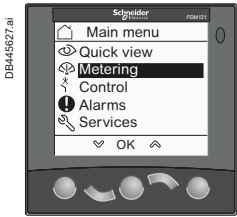

FDM121 display.

FDM121 display

The FDM121 is a display device. It collects the data from devices via the network. It connects to individual breakers:

- MasterPact MTZ1, MTZ2, MTZ3
- ComPact NS, NSX

Display of measurements and trips

The FDM121 is intended to display measurements, trips, and operating information.

It cannot be used to modify the protection settings.

Measurements are easily accessed via a menu.

Trips are automatically displayed.

A pop-up window displays the time-stamped description of the trip.

Status indications

When the circuit breaker is equipped with the Command Module, the FDM121

display can also be used to view circuit breaker status conditions:

- OF: ON/OFF
- SDE: Fault-trip indication (overload, short-circuit, ground fault)

Remote control

When the circuit breaker is equipped with motor mechanism, the FDM121 display can also be used to control the circuit breaker (issuing of open/close commands).

Key characteristics

- 96x96 mm display 128 x 128 pixels
- Monochrome, LED backlight
- Wide viewing angle: 60 x 30°
- Operating temperature range -10 °C to +55 °C
- CE/UL/CSA marking
- 24 V DC power supply
- Consumption 21 mA
- Two RJ45 Jack for ULP

Mounting and Protection

- The FDM121 is easily installed in a switchboard
- The FDM121 degree of protection is IP54

Main menu



General view

The Quick view menu provides quick access to the information essential for operation.



Metering

The Metering menu displays the data made available by the MicroLogic trip unit:



Control

The Control menu is used to control a circuit breaker equipped with a communicating motor mechanism from the FDM121 display.



Alarms

The Alarms menu.



Services

The Services menu contains all the FDM121 display setup functions and the operating assistance information.

Sub menus

Quick view

The Quick view menu provides quick access to the information essential for operation.

Metering

The Metering menu displays the data made available by the MicroLogic trip unit:

- Current, voltage, power, energy, power factor, frequency, and harmonic distortion measurements
- Minimum and maximum metering values

Control

The Control menu is used to control a circuit breaker equipped with a communicating motor mechanism from the FDM121 display.

The proposed commands are:

- Circuit breaker opening
- Circuit breaker closing with or without self-timer
- Circuit breaker reset after trip
- I/O module lighting control
- I/O module load control

Alarms

The Alarms menu is used to display:

- The event log file for the last 40 events and alarms detected by the devices connected to the FDM121 display since the last power-up of the FDM121 display.
- The alarm history (for example, alarms, trips, maintenance, and control status) for the device connected to the FDM121 display

Services

The Services menu contains all the FDM121 display setup functions and the operating assistance information:

- Reset (peak demand values, energy meters, minimum and maximum values)
- Setup (display module date and time, parameters, display settings, date and time, units)
- Maintenance (operation counters, load profile)
- Product version (identification of the intelligent modular units)
- Language (choice of language display)
- Monitoring and controlling the IO modules (IO status, forcing command, pulse counters, and temperature)
- Setup of the IP address of the IFE Ethernet interface for one circuit breaker

Architecture Components

FDM128 Display Unit



FDM128 display.

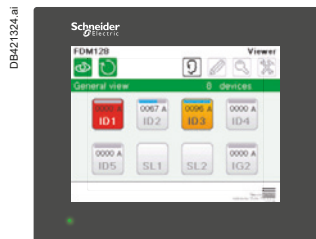

General view

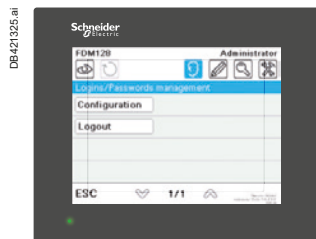

Role base access control

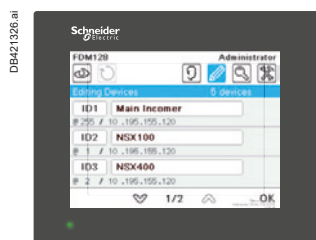

Editing devices

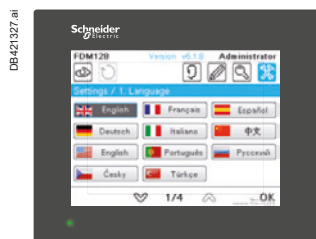

General setting

FDM128 switchboard display

The FDM128 is an intelligent Ethernet touch screen. It collects the data from devices via Ethernet network. It is designed to manage up to 8 devices such as:

- MasterPact MTZ1, MTZ2, MTZ3
- ComPact NS
- ComPact NSX
- Panel server

The FDM128 switchboard display unit can be connected to a ComPact NSX with MicroLogic 5, 6 or 7 via an IFE module. It is easy to use and requires no special software or programming.

The FDM128 has a large screen. It requires very little depth. The anti-glare graphic screen has a backlight for very easy reading even under poor ambient lighting and at sharp angles.

Display of measurements and trips

The FDM128 is intended to display measurements, trips and operating information. It cannot be used to modify the protection settings.

Measurements are easily accessed via a menu.

Trips are automatically displayed.

A pop-up window displays the time-stamped description of the trip.

Status indications

When the circuit breaker is equipped with the Command Module, the FDM128 display can also be used to view circuit breaker status conditions:

- OF: ON/OFF
- SDE: Fault-trip indication (overload, short-circuit, ground fault)

Remote control

When the circuit breaker is equipped with motor mechanism, the FDM128 display can also be used to control the circuit breaker (issuing of open/close commands).

Key characteristics





- 115.2 x 86.4 mm with 5.7" QVGA display 320 x 240 pixels
- Color TFT LCD, LED backlight
- Wide viewing angle: vertical $\pm 80^\circ$, horizontal $\pm 70^\circ$
- High resolution: excellent reading of graphic symbols
- Operating temperature range -10°C to $+55^\circ\text{C}$
- CE/UL/CSA marking
- 24 V DC power supply
- Consumption $\leq 6.8\text{ W}$
- One RJ45 Ethernet jack

Mounting and Protection

- The FDM128 is easily installed in a switchboard
- Standard door hole $\varnothing 22\text{ mm}$
- The FDM128 degree of protection is IP65

Smart Panel Integration Architecture Components FDM128 Display Unit

Main menu

- 
General view
 The Quick view menu provides quick access to the information essential for operation.
- 
Role base access control
 Manage logins and passwords.
- 
Editing devices
 Specify the devices monitored by the FDM128.
- 
Communication setting
 Set the communication parameters.
- 
General setting
 Select the language and to set the other parameters of FDM128.

Sub menus

Quick view
 Provides access to five screens that display a summary of essential operating information (I, U, f, P, E, THD, circuit breaker On/off), protection settings.

Measures
 Display all the measurements (I, U, V, f, P, Q, S, E, THD, PF) with the corresponding min/max values.

Alarms history
 Display tripping and alarms histories.

Control
 Display the status of the devices (Open/Closed) and to initiate control commands (Open/Close/Reset)

Maintenance
 Display all circuit breaker health status indications and all the information generated by the diagnostic functions (number of operations, contact wear, operating time, internal temperature etc.)

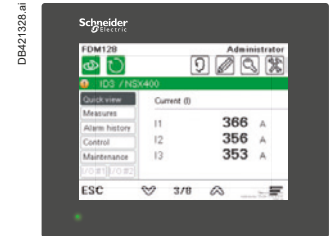

Quick view

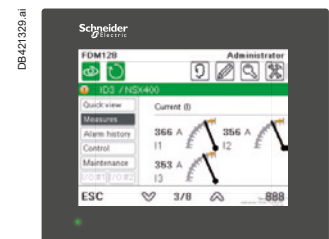

Measures



Alarm history



Control



Maintenance



Customer Engineering Tool: EcoStruxure Power Commission Software

EcoStruxure PowerCommission Experience Project Lifecycle

PB124126.ai



Maintain

Facility managers
Software to track
installation changes
& diagnostic fea-
tures for preventive
maintenance

D

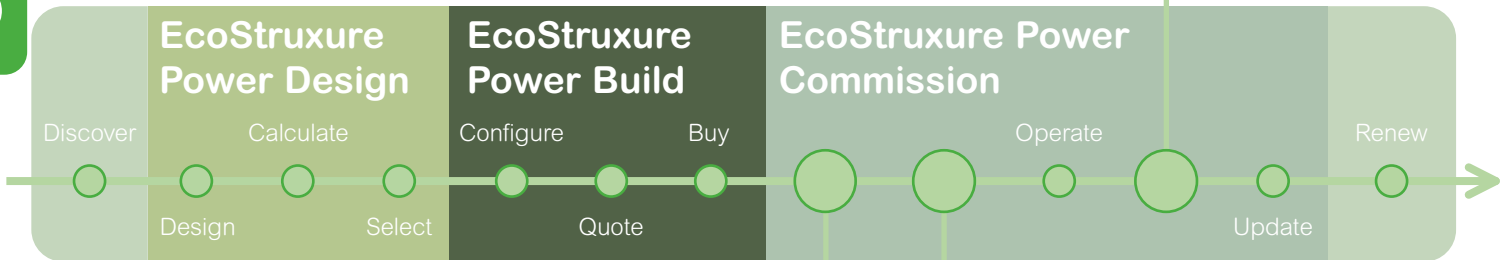

Build

Panel builders
Simple & easy
software to set
up and test a
panelboard



Commission

Electrical contrac-
tors & system
integrator
Shorten commision-
ing time and speed
up SAT delivery with
easy-to-use software

Key Features

Build

I want to test & deliver a “ready to commission” panel

- Device Discovery
- Switchboard setting & testing
- Communication Test & Reports
- Save my project & reports
- Circuit Breaker Functional Tests

Commission

I want to “shorten” my commissioning time

- Device Discovery
- Multi Device Configuration
- Communication Test & Reports
- Save my project & reports

Maintain

I want to ensure “continuity” of services in “safe conditions”

- Settings consistency check
- Device checkup
- Firmware upgrade
- Standard Diagnostic data
- Save my project & reports
- Circuit Breaker Functional Tests

Smart Panel Integration Customer Engineering Tool: EcoStruxure Power Commission Software

Operation and Maintenance

- Devices monitoring and control.
- Measurement parameter logs.
- Log reports.
- Download of current devices settings, compare with previous settings saved in EcoStruxure Power Commission.
- Firmware upgrade and compatibility matrix.

Compatibility

Devices

Configuration of below devices through the range of Enerlin'X interfaces devices.

- Circuit breakers: MasterPact MTZ, ComPact NSX ranges.
- Circuit breakers and control components.

EcoStruxure Power Commission software for PC

- Compatible with Windows 10.

Example of EcoStruxure Power Commission Window

Browsing tabs

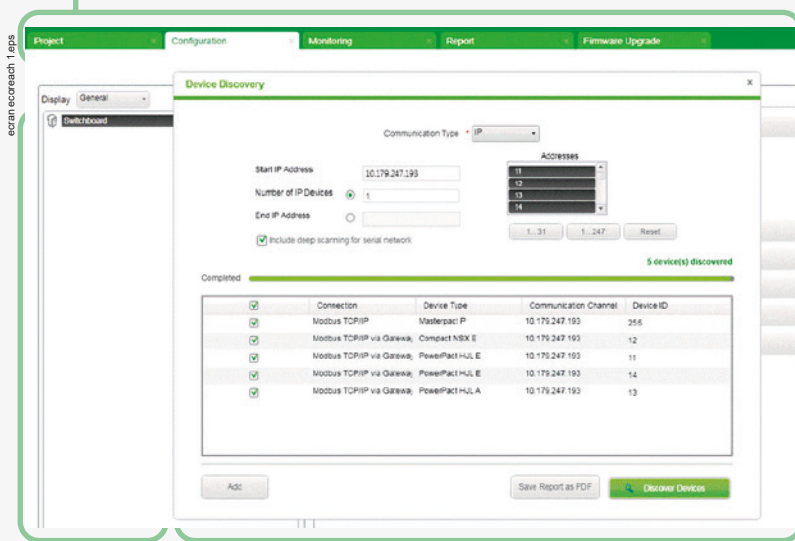

Smart Panels architecture

Contextual window, for monitoring, settings...

Key Features

- **Device Discovery**
EcoStruxure Power Commission helps the user to discover the communicating devices in a switchboard either through Ethernet or a serial network. Once the devices in the switchboard are discovered, the user can add those devices to the project area.
- **Communication Test**
When a user has installed communicating devices in a switchboard, EcoStruxure Power Commission offers the capability to test the communication network. Once a communication test is done, the user can generate a time stamped communication test report.
- **Reports**
EcoStruxure Power Commission offers the following reports to the users
- **Firmware Upgrade**
EcoStruxure Power Commission offers the compatibility check and firmware upgrade for the following devices.



Customer Engineering Tool: EcoStruxure Power Commission Software

Screen: Device homepage

The user can connect to the device from the device home page and configure the settings, check the device, view maintenance information, upgrade the device with the latest firmware.

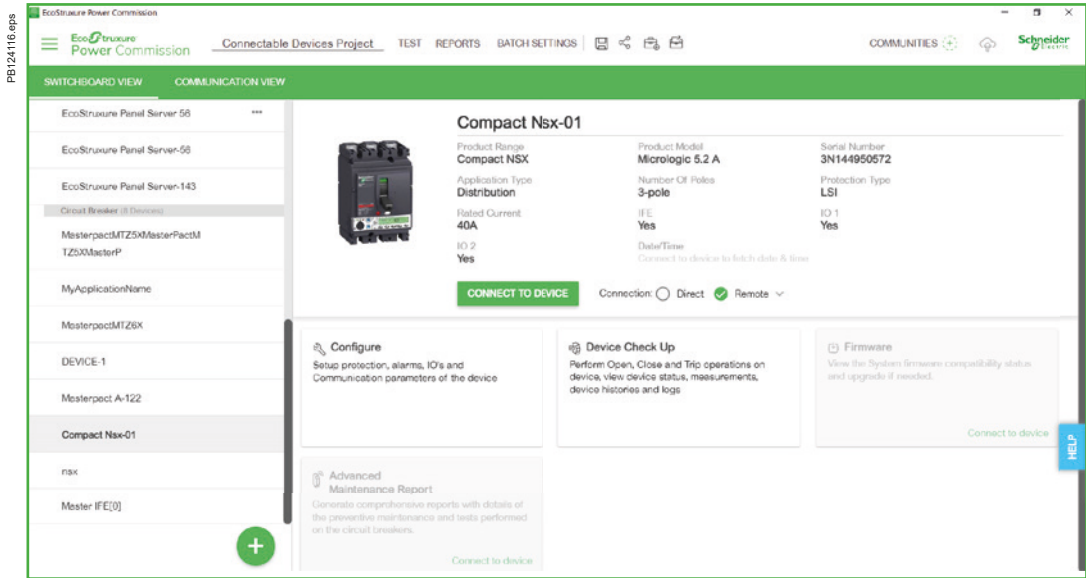

Screen: Device Configure

Once the user clicks on **Configure**, the below screens appear, through which the user can set up protection, alarms, IO's and Communication parameters of the device.

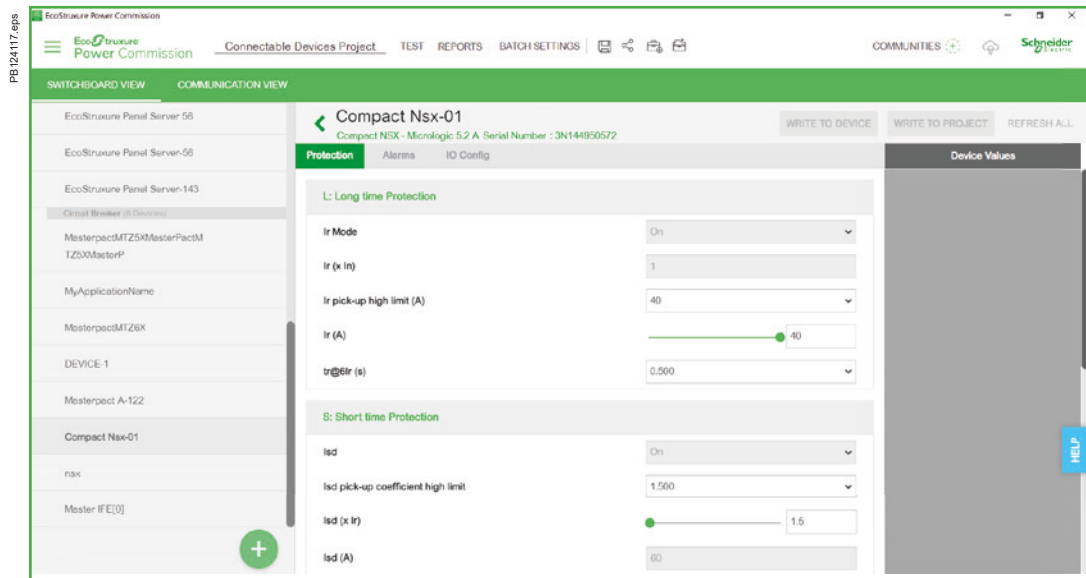

Smart Panel Integration Customer Engineering Tool: EcoStruxure Power Commission Software

Screen: Device Check up

On clicking **Device Check Up**, the below screens appear, through which the user can perform Open, Close and Trip Operations on device, view device status, measurements, device histories and logs.

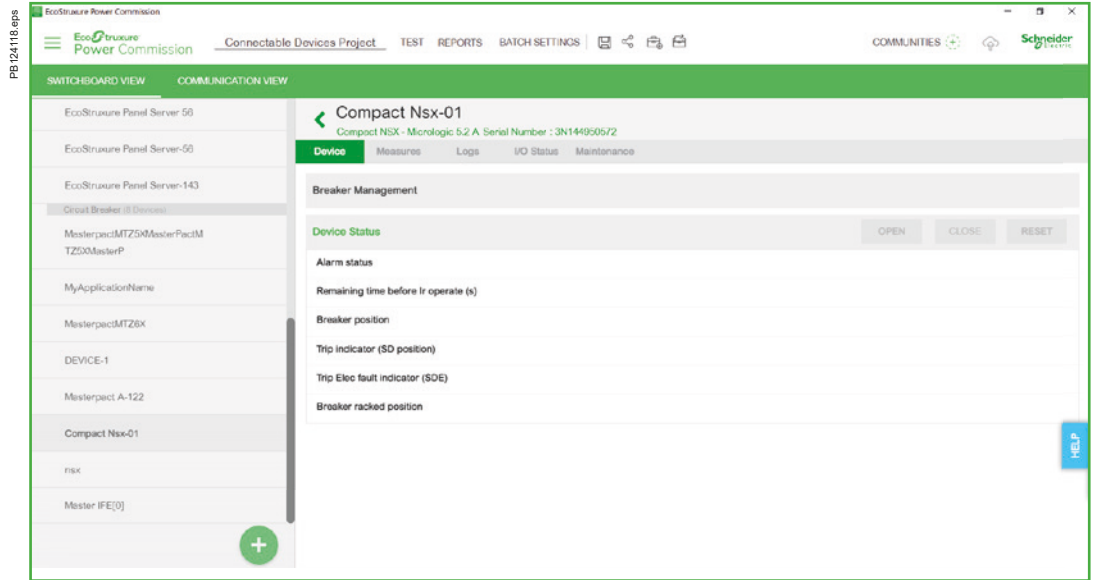

Screen: Firmware upgrade

Through the **Firmware Upgrade** screen, a user can check the compatibility of the firmware versions of the devices and modules connected and upgrade them when needed with the device firmware baseline file.

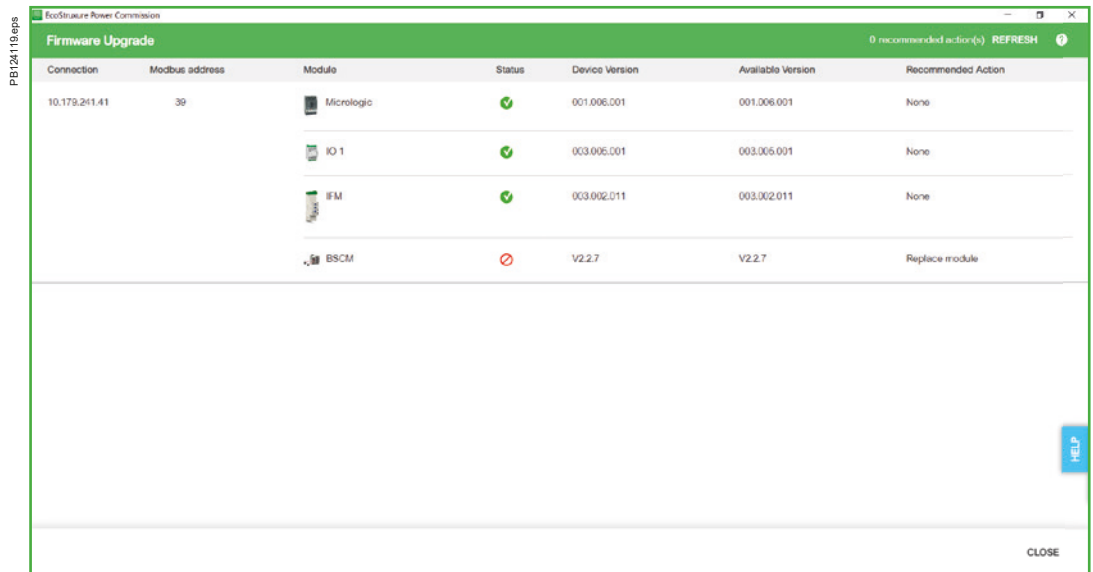

D

Switchboard Integration

ComPacT NSX & NSXm

Operating and Installation Conditions	E-4
Minimum Clearance Distances.....	E-10
Voltage Release Wiring Rules	E-11
Power Loss.....	E-12

ComPacT NSX Temperature Derating

Equipped with Thermal-Magnetic Trip Units	E-13
Equipped with Electronic Trip Units.....	E-15

ComPacT NSX Power Loss

Equipped with Thermal-Magnetic Trip Units	E-17
Equipped with Electronic Trip Units.....	E-18

ComPacT NSX Installation in Switchboards

Safety Clearances and Minimum Distances	E-19
Control Wiring.....	E-20

Service Interface and Power Supplies

.....	E-21
Power Supplies.....	E-22



Other Chapters	
Select Circuit Breakers and Switch-Disconnectors	A-1
Select Protection	B-1
Customize Circuit Breakers with Accessories.....	C-1
Smart Panel Integration	D-1
Catalog Numbers	F-1
Glossary	G-1
Additional Characteristics.....	H-1

Switchboard Integration

ComPacT NSXm Dimensions and Mounting

Circuit Breaker and Switch-DisconnecterE-24

ComPacT NSX Dimensions and Mounting

ComPacT NSX100 to NSX250 Fixed Version, 1P-2PE-33

ComPacT NSX100 to 630 Fixed VersionE-35

ComPacT NSX100 to 630 VigiPacT Add-on Fixed VersionE-36

ComPacT NSX100 to 630 Plug-in Version.....E-37

ComPacT NSX100 to 630 Withdrawable VersionE-39

ComPacT NSX100 to 630 VigiPacT Add-on Plug-in and
Withdrawable Versions.....E-41

Visu Function for ComPacT NSX100 to 250 Fixed VersionE-42

Visu Function for ComPacT NSX400/630 Fixed VersionE-43

Motor Mechanism Module for ComPacT NSX100 to 630E-44

Direct Rotary Handle for ComPacT NSX100 to 630.....E-45

MCC and CNOMO Type Direct Rotary Handles for ComPacT
NSX100 to 630 Fixed VersionE-46

Extended Rotary Handle for ComPacT NSX100 to 630.....E-47

Indication and Measurement Modules for ComPacT NSX100
to 630 Fixed Version.....E-48

One-Piece Spreader for ComPacT NSX100 to 250 Fixed VersionE-49

External ModulesE-50

FDM121 Switchboard DisplayE-51

FDM128 Switchboard DisplayE-52

ComPacT NSX Front-Panel Accessories

ComPacT NSX100 to 630E-53

ComPacT NSX Front-Panel Cutouts

ComPacT NSX100 to 630 Fixed VersionE-55

ComPacT NSX100 to 630 VigiPacT Add-on Fixed VersionE-57

ComPacT NSX100 to 630 Plug-in and Withdrawable Versions....E-59

ComPacT NSX100 to 630 VigiPacT Add-on Plug-in and
Withdrawable Versions.....E-60

Visu Function for ComPacT NSX100 to 630 Fixed VersionE-61

Motor Mechanism Module for ComPacT NSX100 to 630 with/without
VigiPacT Add-onE-62

Direct Rotary Handle for ComPacT NSX100 to 630 with/without

VigiPacT Add-onE-63

Other Chapters

Select Circuit Breakers and Switch-DisconnectorsA-1

Select ProtectionB-1

Customize Circuit Breakers with Accessories.....C-1

Smart Panel IntegrationD-1

Catalog NumbersF-1

GlossaryG-1

Additional Characteristics.....H-1

Switchboard Integration

ComPacT NSX Power Connections

ComPacT NSX100 to 630 with/without
VigiPacT Add-on Fixed VersionE-65
ComPacT NSX100 to 630 with/without
VigiPacT Add-on Plug-in and Withdrawable VersionsE-69
Connection of Insulated Bars or Cables with Lugs to
ComPacT NSX100 to 630 with/without VigiPacT Add-on.....E-73

ComPacT NSX Main Power Connections.....E-74

ComPacT NSXm

AuxiliariesE-75
SDx Module for MicroLogic Vigi 4.1 (ELCB).....E-76

ComPacT NSX

Fixed Circuit Breakers.....E-77
Plug-in/Withdrawable Circuit BreakersE-79
Motor MechanismE-81
SDx Module with MicroLogic.....E-83
SDTAM Module with MicroLogic ME-84
CommunicationE-85



Other Chapters	
Select Circuit Breakers and Switch-Disconnectors	A-1
Select Protection	B-1
Customize Circuit Breakers with Accessories.....	C-1
Smart Panel Integration	D-1
Catalog Numbers	F-1
Glossary	G-1
Additional Characteristics.....	H-1

ComPacT NSX & NSXm

Operating and Installation Conditions

ComPacT NSXm may be mounted vertically, horizontally or flat on their back or on their side without any derating of characteristics.



ComPacT NSXm

Fixed Circuit Breakers

ComPacT NSXm may be mounted vertically, horizontally or flat on their back or on their side without any derating of characteristics. These devices can be mounted on a DIN rail using the integrated DIN rail mounting feature.

For backplate mounting, the devices are supplied with two mounting screws (M4), washers and nuts. These mounting screws can be inserted through mounting holes molded into the device case and threaded into the mounting enclosure, rails or plate.

DB438709.eps

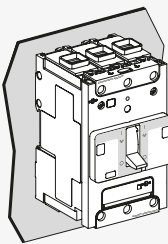

Mounting on a backplate

DB438710.eps

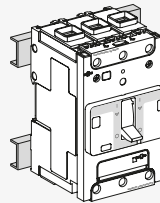

Mounting on rails

DB438711.eps

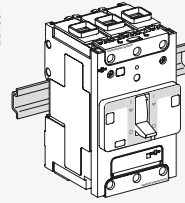

Mounting on DIN rail

E

DB438712.eps

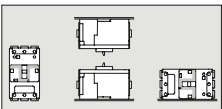

Fixed device installation positions

DB438713.eps

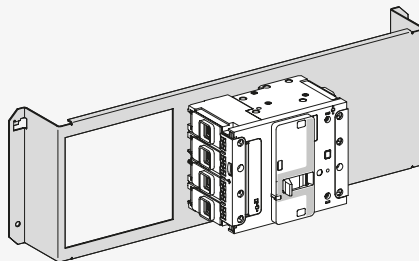

Mounting on a Prisma mounting plate

Switchboard Integration

ComPacT NSX & NSXm

Operating and Installation Conditions

ComPacT NSX circuit breakers may be installed horizontally, vertically or flat on their back, without derating performance levels.

There are three installation versions:

- Fixed
- Plug-in (on a base)
- Withdrawable (on a chassis).

For the last two, components must be added (base, chassis) to the fixed version. Many connection components are shared by the three versions.

Fixed Circuit Breakers

Fixed circuit breakers are designed for standard connection using bars or cables with lugs. Bare-cable connectors are available for connection to bare copper or aluminium cables.

For connection of large cables, a number of solutions with spreaders may be used for both cables with lugs or bare cables.

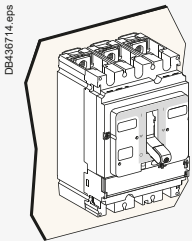

Mounting on a backplate

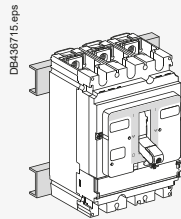

Mounting on rails

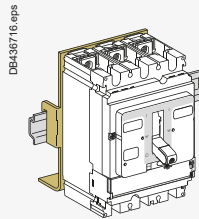

Mounting on DIN rail (with adapter)

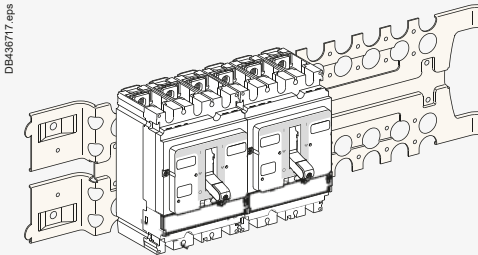

Mounting on a Prisma mounting plate

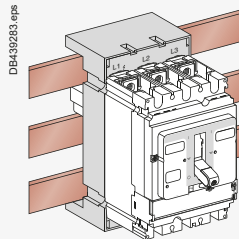

Mounting on busbars with an adapter



Fixed ComPacT NSX250

C250W35E250.eps

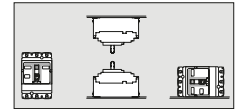

Fixed device installation positions

DB438719.eps



Plug-in ComPacT NSX250

PB-05121-Q.eps

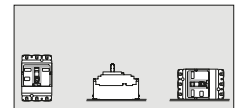

Withdrawable device installation positions

DB438720.eps



ComPacT NSX & NSXm

Operating and Installation Conditions

DB4-36800.ai

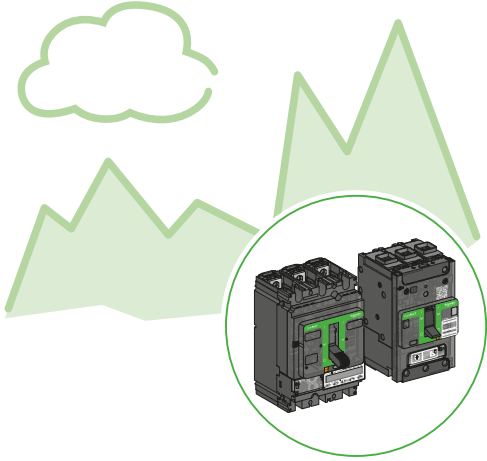

DB4-36801.ai

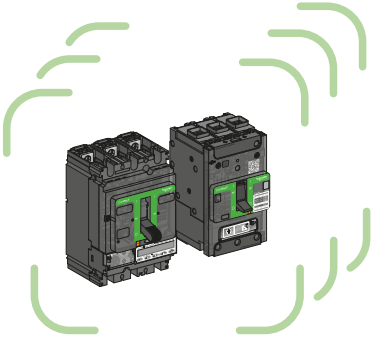

E

DB4-36802.ai

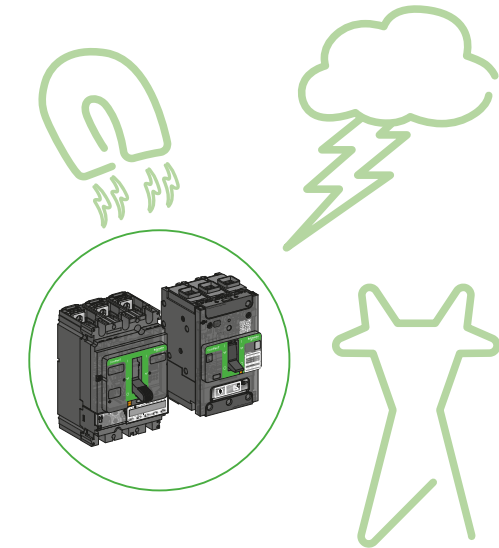

Altitude Derating

Altitude does not significantly affect the characteristics of ComPacT NSX and NSXm circuit breakers up to 2000 m. Above this altitude, it is necessary to take into account the decrease in the dielectric strength and cooling capacity of air. The following table gives the corrections to be applied for altitudes above 2000 m. The breaking capacities remain unchanged.

Altitude (m)		2000	3000	4000	5000	6000	
Impulse withstand voltage	U _{imp} (kV)	8	7.1	6.4	5.6	4.9	
	Insulation voltage	for ComPacT NSX400K	1000	890	795	700	610
for ComPacT NSXm and NSX		800	710	635	560	490	
for ComPacT NSXm with MicroLogic 4		500	445	400	350	350	
Maximum operating voltage 50/60 Hz	for ComPacT NSX 400K	1000	890	795	700	610	
	for ComPacT NSX and NSXm [1]	690	690	635	560	490	
	for ComPacT NSXm or with MicroLogic 4 & 7	440	440	400	350	305	
	for ComPacT NSX + VigiPacT Add-on ELCB [2]	550	550	500	440	385	
Average current capacity	at 40°C	In x	1.0	0.98	0.96	0.94	0.92

[1] Up to 63 A.

[2] Earth Leakage Circuit Breaker.

Vibrations

ComPacT NSX and NSXm devices resist mechanical vibrations. They meet IEC 60068-2-6:

- 2.0 to 13.2 Hz and amplitude ±1 mm
- 13.2 to 100 Hz acceleration ±0.7 g.

Excessive vibration may cause tripping, breaks in connections or damage to mechanical parts.

Electromagnetic Disturbances

ComPacT NSX and NSXm devices are protected against:

- Overvoltages caused by circuit switching
- Overvoltages caused by an atmospheric disturbances or by a distribution-system outage (e.g. failure of a lighting system)
- Devices emitting radio waves (radios, walkie-talkies, radar, etc.)
- Electrostatic discharges produced directly by users.

ComPacT NSX and NSXm devices have successfully passed the electromagnetic-compatibility tests (EMC) defined by the international standards listed [page A-15](#). These tests ensure that:

- No nuisance tripping occurs
- Tripping times are respected.

[1] 640 for ComPacT NSX.

[2] 0.99 for ComPacT NSX.

[3] Earth Leakage Circuit Breaker.



Switchboard Integration

ComPacT NSX & NSXm

Operating and Installation Conditions

Protection Degree

Protection degree of the product, according to IEC 60529, depends of its configuration:

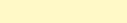
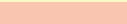
Colors	Definition
	IP54/65: side/front extended rotary handle
	IP40: front cover, side, back, long terminal shield, direct rotary handle
	IP20: power connection cover
	may be IP20 or less depending of the kind of power connections and cable size used

Power Supply from the Top or Bottom

ComPacT NSXm circuit breakers can be supplied from either the top or the bottom, even when equipped with a MicroLogic Vigi 4.1 with integrated earth leakage protection, without any reduction in performance. This capability facilitates connection when installed in a switchboard.

All connection and insulation accessories can be used on circuit breakers supplied either from the top or bottom.

Power Supply from the Top or Bottom^[1]

ComPacT NSX circuit breakers can be supplied from either the top or the bottom, even when equipped with a VigiPacT add-on, without any reduction in performance. This capability facilitates connection when installed in a switchboard.

All connection and insulation accessories can be used on circuit breakers supplied either from the top or bottom.

^[1] All R, HB1, and HB2 circuit breakers are restricted for use as line-load connection. They can not have power fed into the bottom of the circuit breaker. They will be marked with Line and Load markings.

Weight

The table below presents the weights (in kg) of the circuit breakers and the main accessories, which must be summed to obtain the total weight of complete configurations. The values are valid for all performance categories.

Type of device	Circuit breakers	Base	Chassis	VigiPacT add-on	Visu module	Motor mech.	
NSX100	3P/3D	2.05	0.8	2.2	0.87	2	1.2
	4P/4D	2.4	1.05	2.2	1.13	2.2	1.2
NSX160	3P/3D	2.2	0.8	2.2	0.87	2	1.2
	4P/4D	2.58	1.05	2.2	1.13	2.2	1.2
NSX250	3P/3D	2.4	0.8	2.2	0.87	2	1.2
	4P/4D	2.78	1.05	2.2	1.13	2.2	1.2
NSX400/630	3P/3D	6.19	2.4	2.2	2.8	4.6	2.8
	4P/4D	8.13	2.8	2.2	3	4.9	2.8

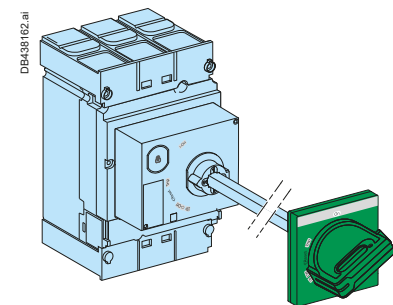
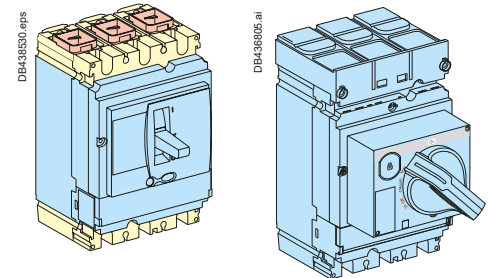
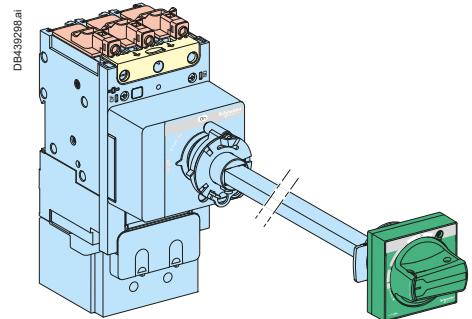
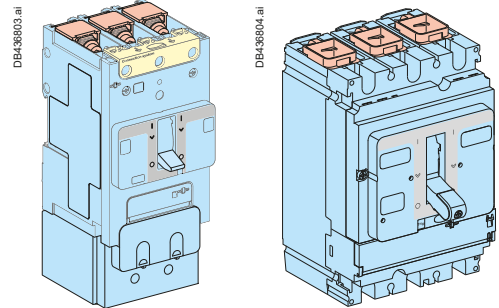

ComPacT NSXm

Operating and Installation Conditions

Derating and Correction Factor Depending of Temperature

The overload protection is calibrated at 40 °C in the lab. This means that when the ambient temperature is less or greater than 40 °C, the Ir protection pick-up is slightly modified.

Choosing the Right Rating Depending on the Temperature:

Over the reference temperature of 40 °C, the circuit breaker has to be derated following the table below:

Temperature derating for thermal-magnetic (TM-D) NSXm at In

Temperature °C						
40	45	50	55	60	65	70
Rating (A) In						
16	16	15	15	14	14	13
25	24	24	23	23	22	21
32	31	30	30	29	28	27
40	39	38	37	36	34	33
50	49	48	46	45	44	42
63	61	60	58	56	54	53
80	77	73	70	67	64	60
100	96	94	90	87	83	80
125	120	117	113	109	104	100
160	155	149	144	139	133	126

Temperature derating for NSXm with MicroLogic Vigi 4.1 at In

Temperature °C						
40	45	50	55	60	65	70
Rating (A) In						
25	25	25	25	25	25	25
50	50	50	50	50	50	50
100	100	100	100	100	100	100
160	155	150	145	140	135	130

Doing the Setting or Calculating the Tripping Time for a Given Temperature:

After having determine the corrected ratio I/I_n , the tripping time at 40 °C is defined with the tripping curves (see pages H-2 to H-3).

To obtain the right setting or the tripping time at a different temperature, the ratio I/I_n has to be corrected with the correction factor below:

Correction factor table for thermal magnetic (TM-D) NSXm to determine setting or tripping time at I_n

Rating (A) I_n	Temperature °C												
	10	15	20	25	30	35	40	45	50	55	60	65	70
16	1.16	1.13	1.11	1.08	1.05	1.03	1.00	0.97	0.94	0.91	0.88	0.85	0.81
25	1.13	1.11	1.09	1.07	1.05	1.02	1.00	0.98	0.95	0.93	0.90	0.88	0.85
32	1.14	1.11	1.09	1.07	1.05	1.02	1.00	0.98	0.95	0.93	0.90	0.87	0.84
40	1.15	1.12	1.10	1.08	1.05	1.03	1.00	0.97	0.95	0.92	0.89	0.86	0.83
50	1.13	1.11	1.09	1.07	1.05	1.02	1.00	0.98	0.95	0.93	0.90	0.87	0.85
63	1.14	1.12	1.10	1.07	1.05	1.02	1.00	0.97	0.95	0.92	0.89	0.86	0.83
80	1.21	1.18	1.14	1.11	1.07	1.04	1.00	0.96	0.92	0.88	0.83	0.80	0.75
100	1.18	1.16	1.12	1.10	1.06	1.04	1.00	0.96	0.94	0.90	0.87	0.83	0.80
125	1.17	1.14	1.11	1.08	1.06	1.03	1.00	0.96	0.93	0.90	0.87	0.84	0.80
160	1.17	1.15	1.12	1.09	1.06	1.03	1.00	0.97	0.93	0.90	0.87	0.83	0.79

Doing the right setting depending of the temperature:

Example: What is the setting to obtain a real I_r of 105 A, taking into account the temperature, for a ComPacT NSXm 125 A?

The necessary dial setting, in amperes, is shown below.

- At 40 °C, $I_r = 105/1 = 105$ A
- At 20 °C, $I_r = 105/1.11 = 95$ A
- At 60 °C, $I_r = 105/0.87 = 121$ A.

Calculating the tripping time at $I_r = I_n$ for a given temperature:

Example: What is the tripping time of a ComPacT NSXm 100A at $I_r = I_n$ for an overload of 500 A?

- At 40 °C, $I/I_r = 5$, tripping time is between 6 and 60 seconds
- At 20 °C, $I/I_r = 5/1.12 = 4.46$, tripping time is between 8 and 80 seconds
- At 60 °C, $I/I_r = 5/0.87 = 5.75$, tripping time is between 5 and 50 seconds

For $I_r = 0.7$ to $0.9 I_n$, additional correction factor need to be applied - please consult us.

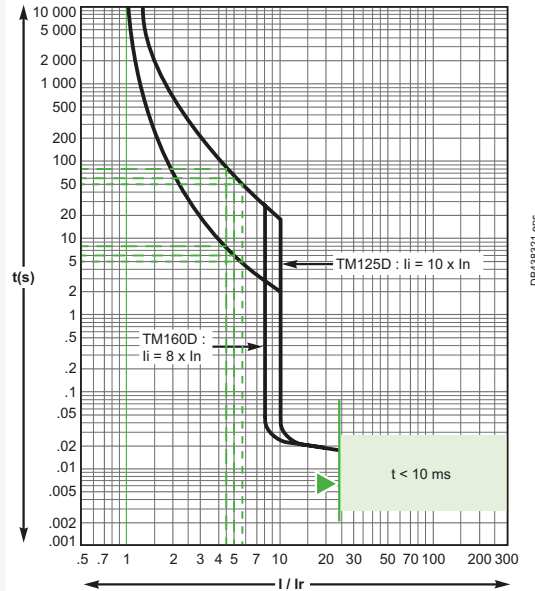

ComPacT NSXm

Minimum Clearance Distances

General Rules

When installing a circuit breaker, minimum clearance distances must be maintained between the device and panels, bars and other protection devices installed nearby. These distances, which depend on the ultimate breaking capacity, are defined by tests carried out in accordance with standard IEC 60947-2.

If installation conformity is not checked by type tests, it is also necessary to:

- Use insulated bars for circuit-breaker connections
- Segregate the busbars using insulating screens.

For ComPacT NSXm devices, terminal shields and interphase barriers are recommended and may be mandatory depending on the kind of power connections of the device and type of installation.

Power Connections

The table below indicates the rules to be respected for ComPacT NSXm devices to ensure insulation of live parts for the various types of connection.

Connection accessories such as crimp lugs, power distribution connectors, and spreaders are supplied with interphase barriers.

Long terminal shields provide a degree of protection of IP40 (ingress) and IK07 (mechanical impact).

The rules to ensure insulation of live parts are described in the following instruction sheets.



For more details on NSXm/NSXm100-160, see [NNZ4764707](#)

E

Clearance Distances

The clearance distances are given in Instruction sheet NNZ4764707 following Schneider Electric tests, they comply with IEC 60947-2.

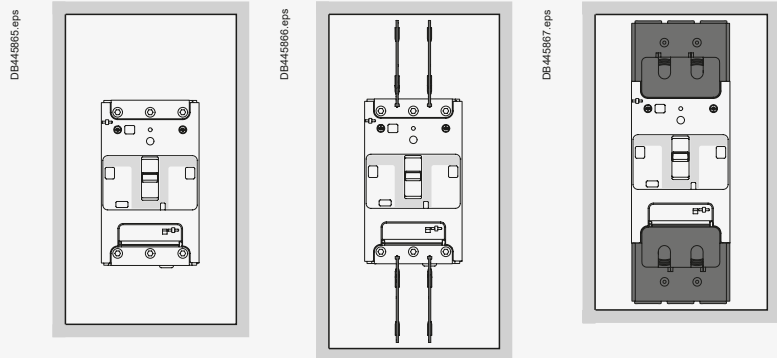

Installation Information on Safety Perimeter

During planning and installing, you must observe the safety perimeters(IEC 61439) taking these recommendations into account:

- Observe the distances between the busbars.
- Do not block the safety perimeter with any object.
- Keep ventilation opening free.
- Check that gases are not directed to connecting terminals, or non-insulated busbars.

Shunt Trip (MX) and Undervoltage Release (MN)

Recommended maximum cable lengths

In certain circumstances, high cable capacitance due to an excessive cable length could prevent an undervoltage release MN from dropping out resulting in safety issues. In case of a shunt trip MX, an untimely trip may occur due to capacitive current leak.

To avoid these dysfunction due to cable capacitance C, the maximum cable length (L) is defined by the following table for a 1.5 mm² cable.

Power supply voltage (Un)	Maximum cable length undervoltage trip (MN) [1]	Shunt trip (MX) [1]
24 V AC	1 243 m	3 653 m
24 V DC	unlimited	> 3653 m
48 V AC	583 m	1 667 m
48 V DC	unlimited	> 1667 m
110...130 V AC	126 m	913 m
110...130 V DC	unlimited	> 913 m
208-240 V AC	109 m	160 m
250 V DC	unlimited	> 160 m
277 V AC	98 m	120 m
380-415 V AC	86 m	80 m
440-480 V AC	56 m	67 m

[1] Make sure auxiliaries supply voltage is within working range (0.85 Un mini...1.1 Un maxi).

If a longer cable length is required, several solutions are possible to counteract excessive cable capacitance:

- Use DC operated auxiliaries
- Use lower control voltage (make sure auxiliaries supply voltage is within working range: 0.85 Un minimum...1.1 Un maximum)
- If high voltage and long control cables are required for an AC undervoltage release (MN), add a rectifier bridge (ref LV426899 – DIN rail compatible) in the control circuit. It will prevent drop out problems but increase operating time.

Electrical Characteristics of MN/MX

Characteristics			AC	DC
Rated voltage (V)			24, 48, 110...130, 208...240, 277, 380...415, 440...480	24, 48, 125, 250
Power requirements	MX	Pickup (< 50 ms)	< 6 VA	< 10 W
		Seal-in	< 4 VA	< 1 W
	MN		< 7 VA	< 2 W
Clearing time (ms)			< 50	< 50
Operating range			up to 1.1 Un	

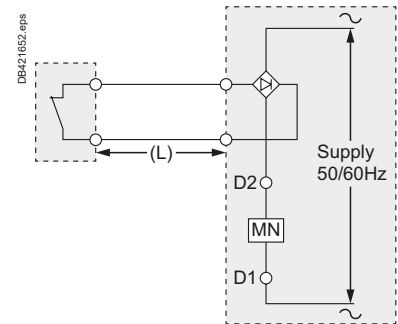
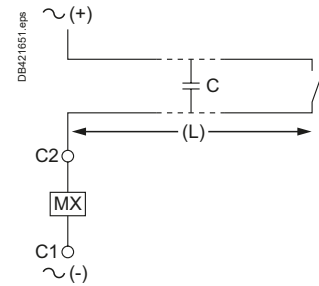
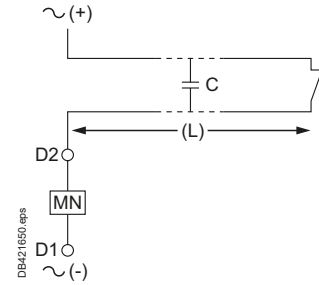

ComPacT NSXm

Power Loss

ComPacT NSXm thermal power loss values are used to calculate total temperature rise in the switchboard in which the circuit breakers are installed.

The values indicated in the tables below are typical values for a device at full rated load and 50/60 Hz.

Power loss per pole (P/pole) in Watts (W)

The value indicated is the power loss at I_n , 50/60 Hz, for a three-pole or four-pole circuit breaker. Measurement and calculation of power loss are carried out in compliance with the recommendations of Annex G of standard IEC 60947-2.

Note: This measurement is not sufficient to determine the quality of the contacts, i.e. the capacity of the circuit breaker to carry its rated current.

Calculation of total power loss

Total power loss at full rated load and 50/60 Hz is equal to power losses per pole multiplied by the number of poles (3 or 4).

ComPacT NSXm with TM-D

Rating (A)	P/Pole (W)
16	2.3
25	2.8
32	3.17
40	3.68
50	4.6
63	5.7
80	5.8
100	7.5
125	9.3
160	13.57

ComPacT NSXm with MicroLogic Vigi 4.1

Rating (A)	P/Pole (W)
25	1.5
50	1.2
100	4.8
160	12.3

ComPacT NSX Temperature Derating Equipped with Thermal-Magnetic Trip Units

When thermal-magnetic trip units are used at ambient temperatures other than 40 °C, the Ir pick-up is modified.

Derating and Correction Factor Depending of Temperature

The overload protection is calibrated at 40 °C in the lab. This means that when the ambient temperature is less or greater than 40 °C, the Ir protection pick-up is slightly modified.

Choosing the Right Rating Depending of the Temperature:

Over the reference temperature of 40 °C, the circuit breaker has to be derated following the table below:

Temperature derating for thermal-magnetic (TM-D) NSX at In							
Temperature °C							
40	45	50	55	60	65	70	
Rating (A) In							
16	15.6	15.2	14.8	14.5	14	13.8	
25	24.5	24	23.5	23	22	21	
32	31.3	30.5	30	29.5	29	28.5	
40	39	38	37	36	35	34	
50	49	48	47	46	45	44	
63	61.5	60	58	57	55	54	
80	78	76	74	72	70	68	
100	97.5	95	92.5	90	87.5	85	
125	122	119	116	113	109	106	
160	156	152	148	144	140	136	
200	195	190	185	180	175	170	
250	244	238	231	225	219	213	
400	390	379.3	368.5	357.3	345.8	334	
630	614.8	599.2	583.3	566.8	549.9	532.4	

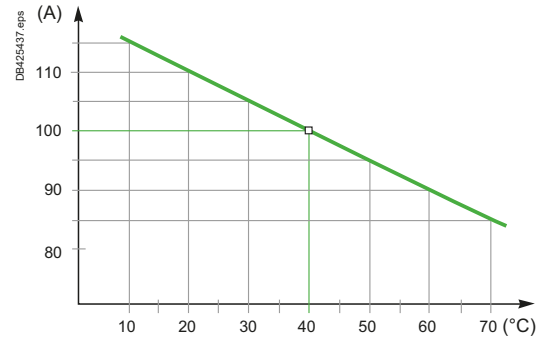

Temperature derating curve for ComPacT NSX100

Doing the Setting or Calculating the Tripping Time for a Given Temperature:

After having determine the corrected ratio I/In, the tripping time at 40 °C is defined with the tripping curves (see pages H-5 to H-7).

To obtain the right setting or the tripping time at a different temperature, the ratio I/In has to be corrected with the correction factor below:

Correction factor table for thermal magnetic (TM-D) NSX to determine setting or tripping time at In													
Rating Temperature °C													
(A) In	10	15	20	25	30	35	40	45	50	55	60	65	70
16	1.15	1.17	1.13	1.13	1.06	1.04	1.00	0.98	0.95	0.93	0.91	0.88	0.86
25	1.15	1.12	1.10	1.08	1.05	1.02	1.00	0.98	0.96	0.94	0.92	0.88	0.84
32	1.15	1.13	1.10	1.07	1.05	1.03	1.00	0.98	0.95	0.94	0.92	0.91	0.89
40	1.15	1.13	1.10	1.08	1.05	1.03	1.00	0.98	0.95	0.93	0.9	0.88	0.85
50	1.15	1.12	1.10	1.08	1.05	1.02	1.00	0.98	0.96	0.94	0.92	0.90	0.88
63	1.14	1.13	1.10	1.08	1.05	1.03	1.00	0.98	0.95	0.92	0.90	0.87	0.86
80	1.15	1.13	1.10	1.08	1.05	1.03	1.00	0.98	0.95	0.93	0.90	0.88	0.85
100	1.15	1.13	1.10	1.08	1.05	1.03	1.00	0.98	0.95	0.93	0.90	0.88	0.85
125	1.15	1.128	1.10	1.07	1.05	1.02	1.00	0.98	0.95	0.93	0.90	0.87	0.85
160	1.15	1.125	1.10	1.08	1.05	1.03	1.00	0.98	0.95	0.93	0.90	0.88	0.85
200	1.15	1.125	1.10	1.08	1.05	1.03	1.00	0.98	0.95	0.93	0.90	0.88	0.85
250	1.15	1.124	1.11	1.08	1.05	1.02	1.00	0.98	0.95	0.92	0.90	0.88	0.85
400	1.15	1.125	1.10	1.08	1.05	1.03	1.00	0.98	0.95	0.93	0.90	0.88	0.85
630	1.15	1.125	1.10	1.08	1.05	1.03	1.00	0.98	0.95	0.93	0.90	0.88	0.85

For Ir = 0.7 to 0.9 In, additional correction factor need to be applied - please consult us.



ComPacT NSX Temperature Derating Equipped with Thermal-Magnetic Trip Units

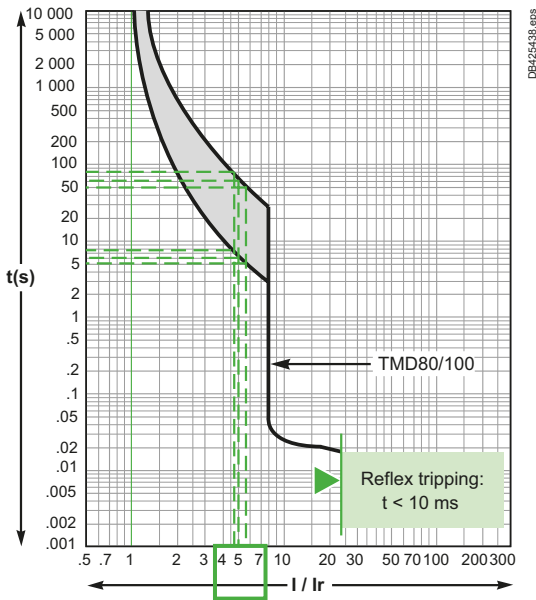

DB925438.eps

Example 1. Fault I = 500 A

I/Ir	4.5	5	5.5
T°C	20 °C	40 °C	60 °C
t min.	8 s	6 s	5 s
t max.	80 s	60 s	50 s

Thermal-protection curve with minimum and maximum values

Example 1. What is the tripping time of a ComPacT NSX100 equipped with a TM100D trip unit set to 100 A, for an overload I = 500 A? The overload I/Ir is calculated as a function of the temperature. Use the above values and the curve on page H-6 (shown on the left) to determine the corresponding time.

- At 40 °C, Ir = 100 A, I/Ir = 5 and the tripping time is between 6 and 60 seconds.
- At 20 °C, Ir = 110 A, I/Ir = 4.54 and the tripping time is between 8 and 80 seconds.
- At 60 °C, Ir = 90 A, I/Ir = 5.55 and the tripping time is between 5 and 50 seconds.

Example 2. What is the setting to obtain a real Ir of 210 A, taking into account the temperature, for a ComPacT NSX250 equipped with a TM250D trip unit? The necessary dial setting, in amperes, is shown below.

- At 40 °C, Ir = (210/250) x 250 A = 210 A
- At 20 °C, Ir = (210/277) x 250 A = 189.5 A
- At 60 °C, Ir = (210/225) x 250 A = 233 A

Additional Derating Coefficient

For NSX100, 160 and 250A, the value indicated in the previous tables are valid for **fixed** circuit breakers equipped with one of the following modules:

- VigiPacT add-on
- VigiPacT add-on alarm
- Current-transformer module.

They also apply for **plug-in or withdrawable** circuit breakers equipped with:

- Current-transformer module.

However, for **plug-in or withdrawable** circuit breakers equipped with a VigiPacT add-on or a VigiPacT add-on alarm, the coefficient 0.84 must be applied.

The table below sums up the situation for add-on modules.

Type of device	Circuit breaker	TM-D trip-unit rating	VigiPacT add-on or VigiPacT add-on alarm	Current transformer module [1], or PowerTag NSX
Fixed	NSX100	16 to 100	1	1
	NSX160 to 250	125 to 160		
	NSX250	200 to 250		
Plug-in or withdrawable	NSX100	16 to 100	0.84	
	NSX160	125 to 160		
	NSX250	200 to 250		

[1] Apply a derating value of 0.84 when associating the CT module with NSX100/160/250 fit with TMD with Ir setting = 0.7 In.

For NSX 400 and NSX 630, the values indicated in the previous table are valid for fixed circuit breakers.

When installed in plug-in or withdrawable versions, a coefficient of 0.84 must be applied.

Please consult us for the derating coefficient when installed in plug-in or withdrawable versions with any add-on module.

ComPacT NSX Temperature Derating Equipped with Electronic Trip Units

Changes in temperature do not affect measurements by electronic trip units.

- The built-in CT sensors with Rogowski toroids measure the current.
- The control electronics compare the value of the current to the settings defined for 40 °C.

Because temperature has no effect on the toroid measurements, the tripping thresholds do not need to be modified.

However, the temperature rise caused by the flow of current and the ambient temperature increase the temperature of the device. To avoid reaching the thermal withstand level of the equipment, it is necessary to limit the current flowing through the device, i.e. the maximum I_r setting as a function of the temperature.

ComPacT NSX100/160/250

The table below indicates the maximum long-time (LT) protection setting I_r (A) depending on the ambient temperature.

Type of device	Rating (A)	Temperature (°C)						
		40	45	50	55	60	65	70
NSX100/160								
Fixed, plug-in or withdrawable	100	no derating						
	160	no derating						
NSX250 + MicroLogic 2.2/5.2/6.2								
Fixed	250	250	250	250	245	237	230	225
Plug-in or withdr.	250	250	245	237	230	225	220	215
NSX250 + MicroLogic Vigi 4.2/7.2								
Fixed	250	250	250	245	237	230	225	218
Plug-in or withdr.	250	225	220	215	210	205	198	190

ComPacT NSX400 and 630

The table below indicates the maximum long-time (LT) protection setting I_r (A) depending on the ambient temperature.

Type of device	Rating (A)	Temperature (°C)						
		40	45	50	55	60	65	70
NSX400 + MicroLogic 2.3/5.3/6.3								
Fixed	400	400	400	400	390	380	370	360
Plug-in/withdr.	400	400	390	380	370	360	350	340
NSX400 + MicroLogic Vigi 4.3/ 7.3								
Fixed	400	400	400	390	380	370	360	350
Plug-in/withdr.	400	400	390	380	370	360	350	340
NSX630 + MicroLogic 2.3/5.3/6.3								
Fixed	630	630	615	600	585	570	550	535
Plug-in/withdr.	630	570	550	535	520	505	490	475
NSX630 + MicroLogic Vigi 4.3/7.3								
Fixed	630	570	555	540	530	515	500	485
Plug-in/withdr.	630	480	470	457	445	435	420	405

Example A fixed ComPacT NSX400 equipped with a MicroLogic can have a maximum I_r setting of:

- 400 A up to 50 °C
- 380 A up to 60 °C.



ComPacT NSX Temperature Derating Equipped with Electronic Trip Units

Additional Derating Coefficient for an Add-on Module

For **fixed** or **plug-in/withdrawable** circuit breakers, the addition of a:

- VigiPacT add-on
- VigiPacT add-on alarm
- Current-transformer module can modify the derating values.
Apply the coefficients shown below.

Derating of a ComPacT NSX equipped with a MicroLogic trip unit

Type of device	Circuit breaker	MicroLogic type	VigiPacT add-on or VigiPacT add-on alarm	PowerTag NSX	Coupling busbar	Current transformer	
Fixed	NSX100	2.2/5.2/6.2	1	1	1	1	
		4.2/7.2	-		1		
	NSX160	2.2/5.2/6.2	1		1		
		4.2/7.2	-		1		
	NSX250	2.2/5.2/6.2	1		1		
		4.2/7.2	-		0.95		
Plug-in or withdrawable	NSX100	2.2/5.2/6.2	1	-	-		
		4.2/7.2	-		-		
	NSX160	2.2/5.2/6.2	1		-		
		4.2/7.2	-		-		
	NSX250	2.2/5.2/6.2	0.86		-		
		4.2/7.2	-		-		
Fixed	NSX400	2.3/5.3/6.3	0.97	0.97	1	1	
		4.3/7.3	-		0.97		
	NSX630	2.3/5.3/6.3	0.9	0.9	1		
		4.3/7.3	-		0.9		
	Plug-in or withdrawable	NSX400	2.3/5.3/6.3	0.97	1		-
			4.3/7.3	-			-
NSX630		2.3/5.3/6.3	0.9	-			
		4.3/7.3	-	-			

Note:

- Coupling busbar is forbidden with VigiPacT add-on.
- Current transformer is forbidden with VigiPacT add-on and coupling busbar.
- Coupling busbar is forbidden with withdrawable installation.
- To provide the Visu function, ComPacT NSX circuit breakers, with or without a VigiPacT add-on, are combined with INV switch-disconnectors.
Tripping values for the selected combination are indicated in the ComPacT INS/INV catalog.

E

ComPacT NSX Power Loss Equipped with Thermal-Magnetic Trip Units

ComPacT NSX thermal power loss values are used to calculate total temperature rise in the switchboard in which the circuit breakers are installed.

The values indicated in the tables below are typical values for a device at full rated load and 50/60 Hz.

Power loss per pole (P/pole) in Watts (W)

The value indicated is the power loss at I_N , 50/60 Hz, for a three-pole or four-pole circuit breaker. Measurement and calculation of power loss are carried out in compliance with the recommendations of Annex G of standard IEC 60947-2.

Note: This measurement is not sufficient to determine the quality of the contacts, i.e. the capacity of the circuit breaker to carry its rated current.

Additional power loss

Additional power loss is equal to the sum of the power dissipated by the following:

- VigiPacT add-on: note that the deviation of the N and L3 bars required to pass through the toroid results in higher power losses compared to those of the L1 and L2 bars (diagram opposite). When calculating total power loss, use L1, L2, L3 for a 3P device and N, L1, L2, L3 for a 4P device
- Disconnecting contacts (plug-in and withdrawable devices)
- Transformer module.

Calculation of total power loss

Total power loss at full rated load and 50/60 Hz is equal to the sum of the device and additional power losses per pole multiplied by the number of poles (2, 3 or 4).

If a Vigi is installed, it is necessary to differentiate between N and L3 on one hand and L1 and L2 on the other.

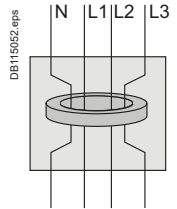

With a VigiPacT add-on, the deviation of the N and L3 bars required to pass through the toroid results in higher power losses compared to those of the L1 and L2 bars

ComPacT NSX 100 to 630 Equipped with TM-D and TM-G Trip Units

Type of device	Fixed device		Additional power/pole					
	3/4 poles	Rat. (A)	P/pole	VigiPacT add-on (N, L3)	VigiPacT add-on (L1, L2)	Plug-in/ withdr.	Transfo. module	PowerTag NSX module
NSX100	16	2.92	0	0	0	0	0	0
	25	4.01	0	0	0.1	0	0	0
	32	4.03	0.06	0.03	0.15	0.1	0	0
	40	5.47	0.10	0.05	0.2	0.1	0	0
	50	4.11	0.15	0.08	0.3	0.1	0.1	0.1
	63	8.61	0.3	0.15	0.4	0.1	0.1	0.1
	80	8.77	0.4	0.2	0.6	0.1	0.1	0.1
	100	8.8	0.7	0.35	1	0.2	0.2	0.2
NSX160	80	8.06	0.4	0.2	0.6	0.1	0.1	0.1
	100	7.7	0.7	0.35	1	0.2	0.2	0.2
	125	10.78	1.1	0.55	1.6	0.3	0.3	0.3
	160	14.08	1.8	0.9	2.6	0.5	0.5	0.5
NSX250	125	9.53	1.1	0.55	1.6	0.3	0.3	0.3
	160	11.78	1.8	0.9	2.6	0.5	0.5	0.5
	200	15.6	2.8	1.4	4	0.8	0.8	0.8
	250	18.75	4.4	2.2	6.3	1.3	1.3	1.3
NSX400	320	12.8	3.2	1.6	6.14	1.54	1.43	1.43
NSX630	500	25.6	13.99	7	15	3.75	3.5	3.5

ComPacT NSX100 to 630 Equipped with MA/1.3-M Trip Units

Type of device	Fixed device		Additional power/pole					
	3 poles	Rat. (A)	P/pole	VigiPacT add-on (N, L3)	VigiPacT add-on (L1, L2)	Plug-in/ withdr.	Transfo. module	PowerTag NSX module
NSX100	2.5	0.93	0	0	0	0	0	0
	6.3	3.93	0	0	0	0	0	0
	12.5	0.63	0	0	0	0	0	0
	25	1.12	0	0	0	0.1	0	0
	50	1.68	0.2	0.1	0.3	0.1	0.1	0.1
	100	5.2	0.7	0.35	1	0.2	0.2	0.2
NSX160	150	8.55	1.35	0.68	2.6	0.45	0.5	0.5
NSX250	220	14.52	2.9	1.45	4.89	0.97	1	1
NSX400	320	12.29	3.2	1.6	6.14	1.54	1.43	1.43
NSX630	500	25	13.99	7	15	3.75	3.5	3.5



ComPacT NSX Power Loss

Equipped with Electronic Trip Units

The values indicated in the table below are typical values for a device at full rated load and 50/60 Hz. The definitions and information are the same as that for circuit breakers equipped with thermal-magnetic trip units.

ComPacT NSX100 to 630 Equipped with MicroLogic Trip Units

Type of device 3/4 poles	Rating (A)	Fixed device		Additional power (W)/ pole				
		P/Pole (w)		VigiPacT add-on (N/ L3)	VigiPacT add-on (L1/L2)	Plug-In	Transfo Module	PowerTag NSX module
NSX + MicroLogic 2.2/5.2/6.2								
NSX100	<40 A	1.3		0.1	0.06	0.2	0.1	0
	40 A ≤ 100 A	4.7		0.7	0.35	1	0.2	0.2
NSX160	<40 A	1.2		0.4	0.2	0.6	0.1	0
	40 A ≤ 160 A	9.2		1.8	0.9	2.6	0.5	0.5
NSX250	<40 A	0.43		1.1	0.55	1.6	0.2	0
	40 A ≤ 250 A	17.6		4.4	2.2	6.3	1.3	1.3
NSX + MicroLogic 2.3/5.3/6.3								
NSX400	<400 A	19.2		3.2	1.6	9.6	2.4	2.24
NSX630 ^[1]	<630 A	39.7		6.5	3.25	19.49	5.95	5.56
NSX + MicroLogic 4.2/7.2			N/L1/L3	L2				
NSX100	<100 A	5.8	4.9	-	-	1	0.2	0.2
NSX160	<160 A	12.3	10.0	-	-	2.6	0.5	0.5
NSX250	<250 A	25	20.6	-	-	6.3	1.3	1.3
NSX + MicroLogic 4.3/7.3								
NSX400	<400 A	25.6	22.4	-	-	9.6	2.4	2.24
NSX630 ^[1]	<630 A	45.5	39	-	-	19.49	5.95	5.56

Power loss values presented above are not contractual.

[1] The power loss values for VigiPacT add-on and withdrawable circuit breakers are given for 570 A.

ComPacT NSX Installation in Switchboards

Safety Clearances and Minimum Distances

General Rules

When installing a circuit breaker, minimum clearance distances must be maintained between the device and panels, bars and other protection devices installed nearby. These distances, which depend on the ultimate breaking capacity, are defined by tests carried out in accordance with standard IEC 60947-2.

If installation conformity is not checked by type tests, it is also necessary to:

- Use insulated bars for circuit-breaker connections
- Segregate the busbars using insulating screens.

For ComPacT NSX100 to 630 devices, terminal shields and interphase barriers are recommended and may be mandatory depending on the operating voltage of the device and type of installation (fixed, withdrawable, etc.).

Power Connections

The table below indicates the rules to be respected for ComPacT NSX100 to 630 devices to ensure insulation of live parts for the various types of connection.

- Fixed devices with front connection (FC) or rear connection (RC).
- Plug-in or withdrawable devices.

Connection accessories such as crimp lugs, bare-cable connectors, terminal extensions (straight, right-angle, double-L and 45°) and spreaders are supplied with interphase barriers.

Long terminal shields provide a degree of protection of IP40 (ingress) and IK07 (mechanical impact).

The rules to ensure insulation of live parts are described in the following instruction sheets.

Clearance Distances

The clearance distances are given in Instruction sheet NNZ4764707 following Schneider Electric tests, they comply with IEC 60947-2.

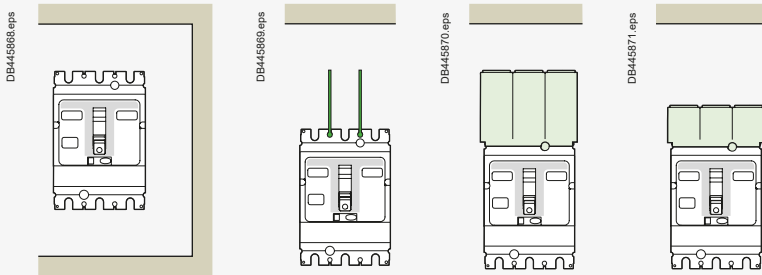

Installation Information on Safety Perimeter

During planning and installing, you must observe the safety perimeters (IEC 61439) taking these recommendations into account:

- Observe the distances between the busbars.
- Do not block the safety perimeter with any object.
- Keep ventilation opening free.
- Check that gases are not directed to connecting terminals, or non-insulated busbars.



For more details on NSX100-250, see [NNZ4765407](#)



For more details on NSX400-630, see [NNZ4765507](#)



For more details on NSX400 K, see [NNZ5517107](#)

For ComPacT NSX High Performance, see the [User Guide](#)



DOCA0187EN



ComPacT NSX Control Wiring

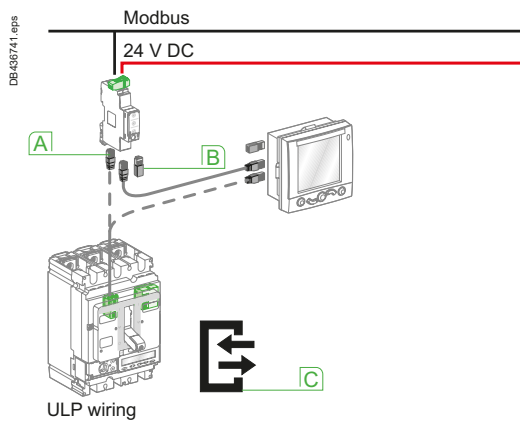
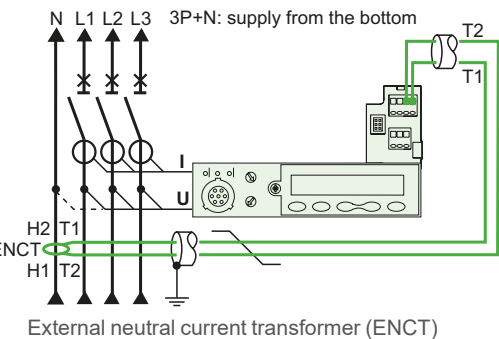
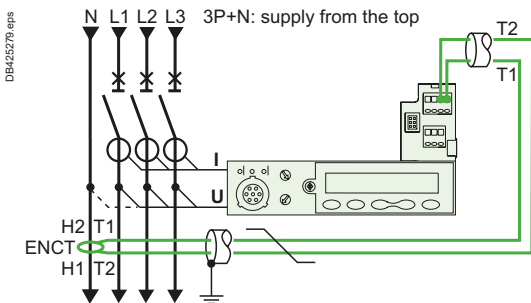
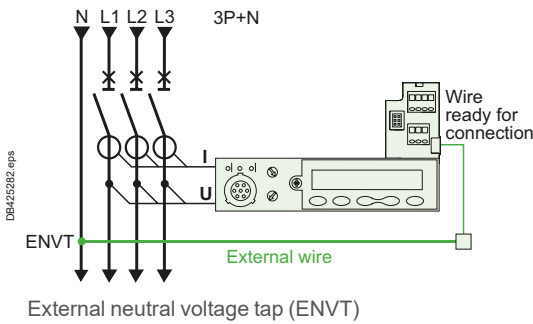

Remote Tripping by MN or MX Release

Power consumption is approximately:

- 30 VA for pick-up of the MN and MX releases
- 300 VA to 500 VA for the motor mechanism.

The table below indicates the maximum permissible cable length for different supply voltages and cable cross-sectional areas.

Recommended maximum cable lengths (in metres)

Power supply voltage (V DC)		12 V		24 V		48 V	
Cable cross-section (mm ²)		1.5	2.5	1.5	2.5	1.5	2.5
MN	U source 100 %	15	–	160	–	640	–
	U source 85 %	7	–	40	–	160	–
MX	U source 100 %	60	–	240	–	960	–
	U source 85 %	30	–	120	–	480	–
Motor mechanism	U source 100 %	–	–	10	16	65	110
	U source 85 %	–	–	2	4	17	28

Note: The indicated length is that of each of the two wires.

External Neutral Voltage Tap (ENVT)

This connection is required for accurate power measurements on 3-pole circuit breakers equipped with MicroLogic 5/6 E trip units in installations with a distributed neutral. It can be used to measure phase-neutral voltages and calculate power using the 3 wattmeter method.

ComPacT NSX 3-pole circuit breakers come with a wire installed on the device for the connection to the ENVT.

This wire is equipped with a connector for connection to an external wire with the following characteristics:

- Cross-sectional area of 1 mm² to 2.5 mm²
- Maximum length of 10 metres.

External Neutral Current Transformer (ENCT)

This connection is required to protect the neutral on 3-pole circuit breakers equipped with MicroLogic 5/6 E trip units in installations with a distributed neutral. For MicroLogic 6 E, it is required for type G ground-fault protection.

The ENCT is connected in the same way for fixed, plug-in or withdrawable devices:

- Fixed devices are connected via terminals T1 and T2 of the internal terminal block.
- Plug-in and withdrawable devices are not connected via the auxiliary terminals. The wires must be connected/disconnected inside the device via terminals T1 and T2.

The ENCT must be connected to the MicroLogic trip unit by a shielded twisted pair. The shielding should be connected to the switchboard earth only at the CT end, no more than 30 cm from the CT.

- The power connections of the CT to the neutral (H2 and H1) must be made in the same way for power supply from the top or the bottom (see figure). Make sure they are not reversed for devices with power supply from the bottom.
- Cross-sectional area of 0.4 mm² to 1.5 mm²
- Maximum length of 10 metres.

ULP Connection System between MicroLogic, FDM121 Switchboard Display and Modbus Interface

The ULP (Universal Logic Plug) wiring system used by ComPacT NSX for connections through to the Modbus network requires neither tools nor settings. The prefabricated cords are used for both data transfer and distribution of 24 V DC power. Connectors on each component are identified by ULP (Universal Logic Plug) symbols, ensuring total compatibility between each component.

Available cords

All connections are made with prefabricated cords:

- NSX cord for connection of the internal terminal block to the Modbus interface or the FDM121 display via an RJ45 connector. The cord is available in three lengths, 0.35 m, 1.3 m and 3 m
- ULP cords with RJ45 connectors at each end for the other connections between components. The cord is available in six lengths, 0.3 m, 0.6 m, 1 m, 2 m, 3 m and 5 m. For greater distances, two cords can be interconnected using the RJ45 female/female accessory.

Maximum length of 10 m between 2 modules and 30 m in all.

A line terminator must be fitted to all components with an unused RJ45 connector.

Service Interface and Power Supplies

MicroLogic power supply

The external power-supply module makes it possible:

- To use the display even if the circuit breaker is open or not supplied (for the exact conditions of use, see the “electrical diagrams” part of this catalog)
- To display fault currents after tripping
- To modify settings when the circuit breaker is open (OFF position)

An external 24 V DC power supply is required for installation with communication, whatever the type of trip unit.

This module is not designed to power on 24 V DC voltage releases and electric motor mechanism.

We recommend using the MicroLogic power supply due to its low stray primary secondary capacitance. Good operation of the MicroLogic control unit in noisy environment is not guaranteed with other power supplies.

Characteristics

- Power supply AC-to-DC or DC-to-DC
- Output voltage: 24 V DC ±5 %.
- Output current: 1 A.
- DIN rail or platine Fixing with Acti9 form factor
- Conducted emissions power line: class B per IEC/EN 61000-6-3

Service Interface [1]

The Service Interface is a portable instrument designed for field testing.

The Service Interface is to be used together with EPC software for testing and configuration of MicroLogic trip units mounted in the following low voltage circuit breakers:

- ComPacT NS 630b-1600 circuit breakers
- ComPacT NS 1600b-3200 circuit breakers
- PowerPacT P- and R- frame circuit breakers
- MasterPact NT/NW circuit breakers

EcoStruxure Power Commission (EPC) is a global software with test functions features for testing the circuit breakers and communication accessories through the Service Interface.

EPC software allows you to perform the following actions on communicating MicroLogic trip unit through the Service Interface:

1. Automatic trip curve tests
2. Device check up (Force trip test)
3. Zone-selective interlocking test (ZSI)
4. Preparation for primary injection tests

The main features of Service Interface are:

- Single connector interface for testing different circuit breakers.
- 24 Vdc at 120 mA power output for external devices.
- 12 kV safety impulse protection between user interface and test port.
- Magnet mountable.
- EPC user interface for test and configuration.

[1] Please consult Schneider Electric Services.



External 24 V DC power supply module (AD)

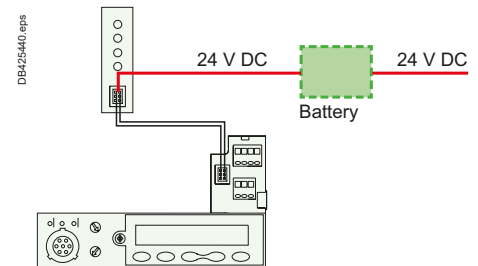

Power supply, without the Communication function, via the terminal block with a backup battery



BTM (Breaker Test Module)



PF106348SE_ABL8RPS24030.eps



ABL8 RPS power supply

24 V DC Universal Phaseo™ ABL8 Power Supplies

The Universal Phaseo ABL8 RPS 24050 and ABL8 RPS 24030 power supplies can be connected phase-to-neutral or phase-to-phase.

They deliver a voltage that is precise to 3%, whatever the load and whatever the value of the AC supply, within the ranges 85 to 132 V AC and 170 to 550 V AC.

The Universal Phaseo ABL8 powers:

- Circuit breaker communication module and interface
- Programmable MicroLogic.

Characteristics

- Power supply AC-to-DC
- Network frequency: 50/60 Hz (±5 %)
- Output voltage: 24 V DC ±3%.
- Output current: 3 or 5 A
- DIN rail or platine Fixing
- Conducted emissions power line: class B per IEC/EN 61000-6-3

To assist cooling there must be sufficient clearance around the Universal range Phaseo power supplies:

- 50 mm above and below
- 10 mm on the side.

		ABL8RPS●●●●	MicroLogic Power Supply
Over Voltage Category		Cat I per VDE 0106-1	Cat IV per IEC 62477-1 (AC model) Cat III per IEC 62477-1 (DC model) Cat III per UL 61010-1
Degree of pollution as per IEC 60664-1		2	3
Input supply voltage AC		100...120 V AC and 200...500 V AC	110-130 or 200-240 V AC
Input supply voltage DC		N/A	24-30 or 48-60 or 100-125 V DC
Dielectric	Input/Output	4 kV rms - 1 mn.	3 kV rms - 1 mn. (110-130 V AC and 200-240 V AC model)
			3 kV rms - 1 mn. (110-125 V DC model)
			2 kV rms - 1 mn. (24-30 V DC and 48-60 V DC model)
	Input/Ground	3.5 kV rms - 1 mn.	3 kV rms - 1 mn.
	Output /Ground	0,5 kV rms - 1 mn.	1.5 kV rms - 1 mn.
Temperature		■ 50 °C	70 °C
		■ 60 °C with 80 % of the rated current maximum	
Output current		3 A (ABL8RPS24030) 5 A (ABL8RPS24050)	1 A
Inrush current for 2 ms		< 30 A	< 20 A
Ripple		200 mV peak-peak	200 mV peak-peak
Output voltage limits		24 to 28.8 V DC	22.8 to 25.2 V DC
Protection degree		IP20	IP4x front face/IP2x terminals/ IP3x other

Note: For the applications requiring an over voltage category higher than 2, a surge arrester shall be associated to ABL8 RPS power supplies. The iQuick20prd type 2 surge arrester is recommended.

Wiring (See Page E-86)

MicroLogic 5/6/7 not using the Communication function

The external 24 V DC supply is connected via the circuit breaker terminal block. Use of a 24 V DC battery provides backup power for approximate 3 hours (100 mA) in the event of an interruption in the external supply.

MicroLogic 5/6/7 using the Communication function

The external 24 V DC supply is connected via the Modbus interface using a five-pin connector, including two for the power supply. Stacking accessories (see page D-2) can be used to supply a number of interfaces by fast clip-on connection. The 24 V DC power is distributed downstream by the ULP (Universal Logic Plug) communication cords with RJ45 connectors. This system ensures both data transfer and power distribution to the connected modules.

Recommendations for 24 V DC wiring

- Do not connect the positive terminal to earth.
- Do not connect the negative terminal to earth.
- The maximum length for each conductor (+/-) is ten metres.
- For connection distances greater than ten metres, the plus and minus conductors of the 24 V DC supply must be twisted to improve EMC.
- The 24 V DC conductors must cross the power cables perpendicularly. If this is difficult or impossible, the plus and minus conductors must be twisted.

Only one device can be powered through the ULP cord. This device must be at the end of the ULP line. It can be done only for the following devices:

- FDM121 display
- BSCM module and MicroLogic trip unit for ComPacT NSX circuit breakers
- BSCM module for ComPacT NSX DC circuit breakers.

For more information, see the ULP Guide ([DOCA0093EN](#)), and page E-85 for an example.

Modbus (See Page E-86)

Each ComPacT NSX circuit breaker equipped with MicroLogic 5/6/7 and an FDM121 display is connected to the Modbus network via the Modbus interface module.

Connection of all the circuit breakers and other Modbus devices in the switchboard to a Modbus bus is made much easier by using a Modbus RJ45 junction block installed in the switchboard.

Recommendations for Modbus wiring

- The shielding may be earthed.
- The conductors must be twisted to improve immunity (EMC).
- The Modbus conductors must cross the power cables perpendicularly.

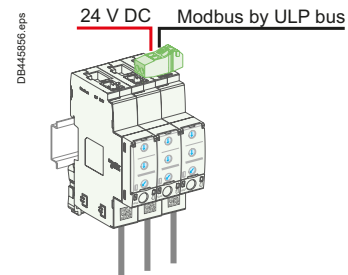

Power supply, with the Communication function, via the Modbus interface

ComPacT NSXm Dimensions and Mounting

Circuit Breaker and Switch-Disconnecter

Circuit Breaker

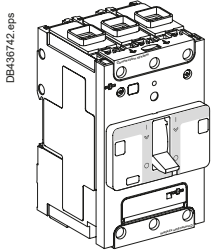

3P

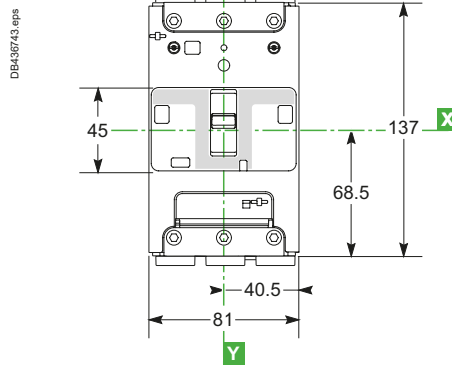

4P

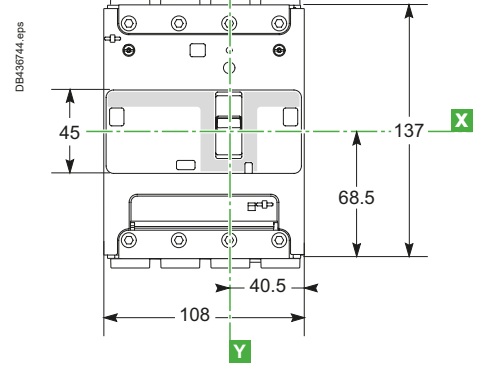

Circuit Breaker with MicroLogic Vigi 4.1

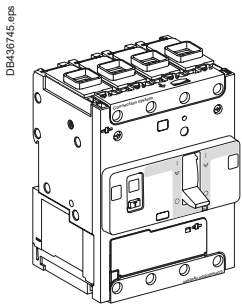

3P

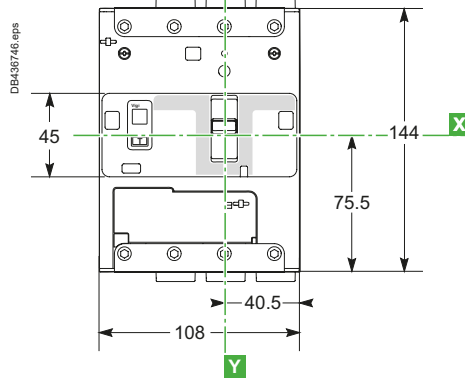

4P

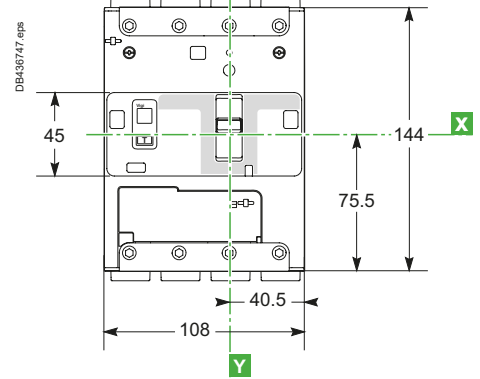

E

Side View

With SDx Module

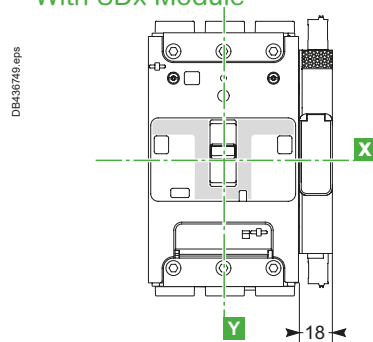
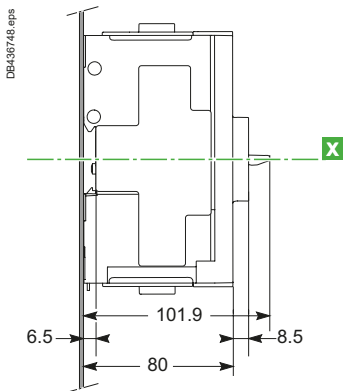

Front-Panel Cutouts

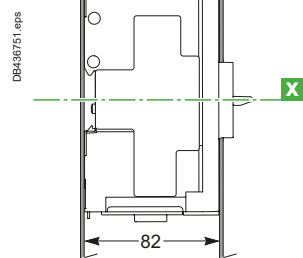
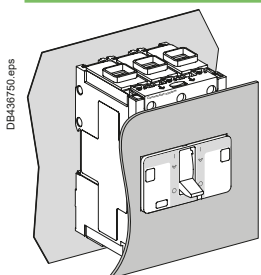

3P

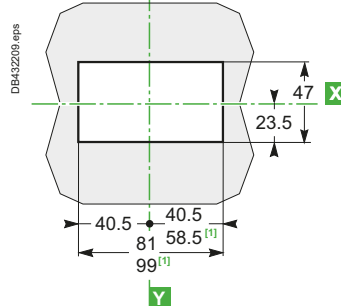

4P

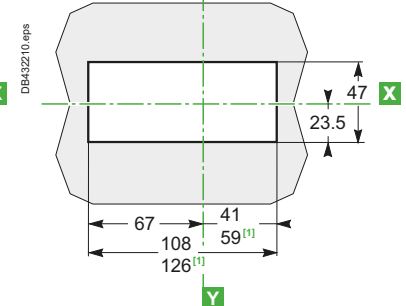

[1] With SDx module.

ComPacT NSXm Dimensions and Mounting Circuit Breaker and Switch-Disconnect

Connectors

EverLink with Control Wire Terminal Connector

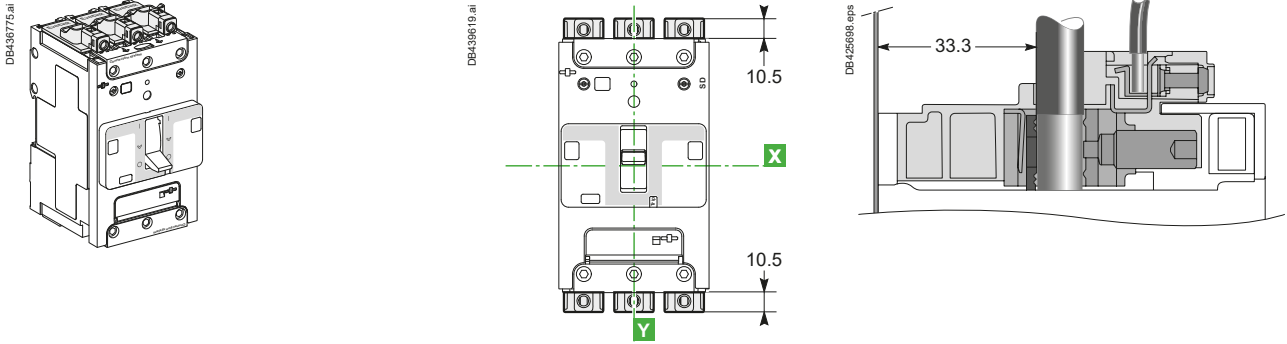

EverLink without Control Wire Terminal Connector

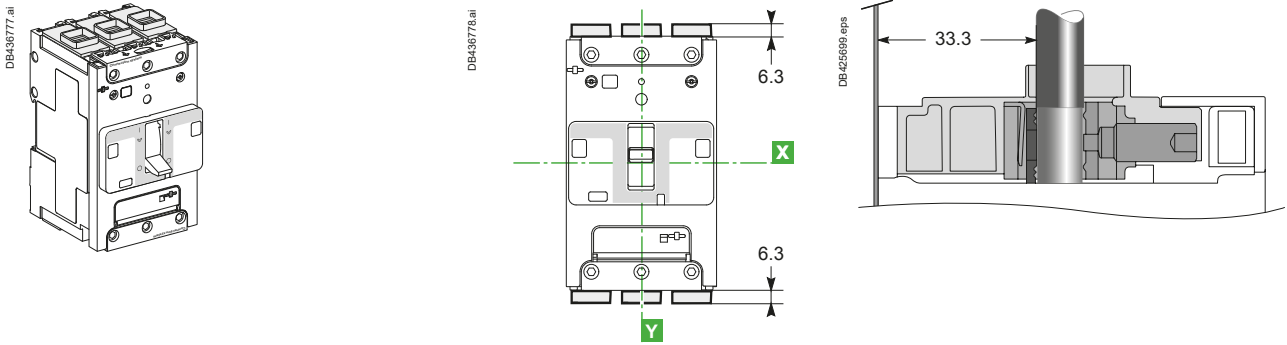

Mechanical Lug Connector

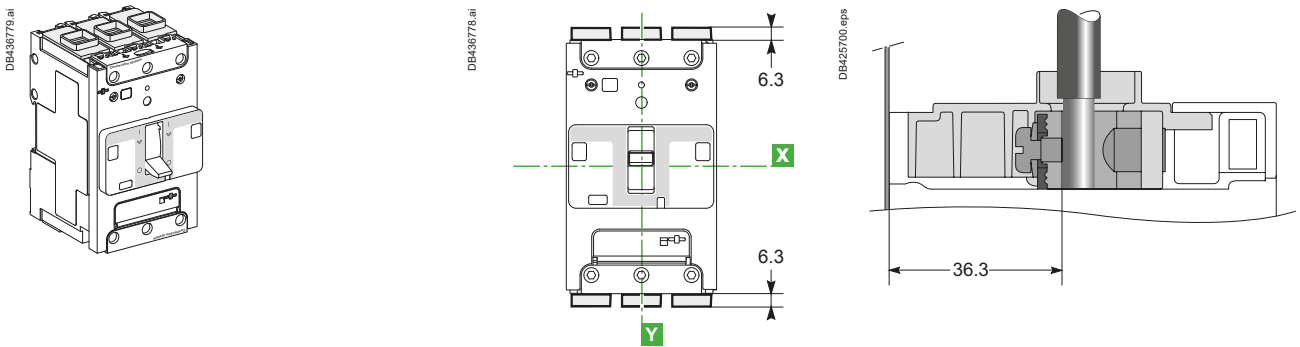

Compression Lug/Busbar Connector

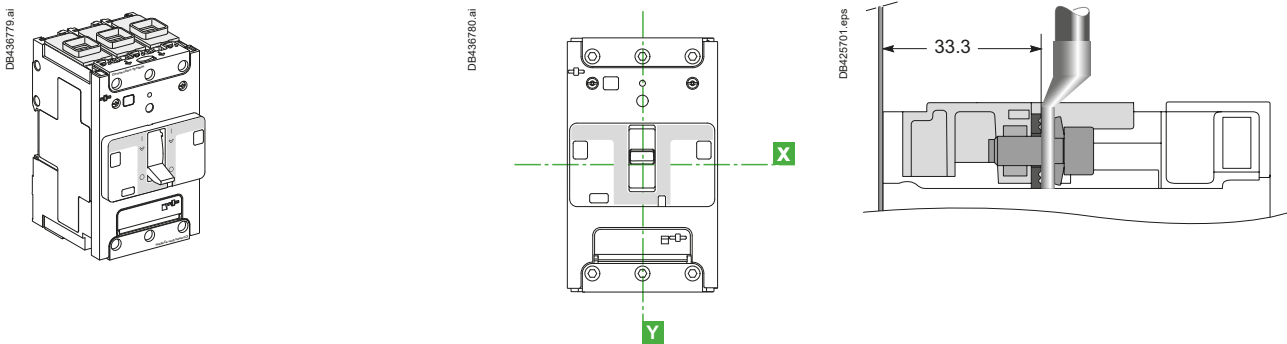

ComPacT NSXm Dimensions and Mounting

Circuit Breaker and Switch-Disconnecter

Insulation of Live Parts

Long Terminal Shields

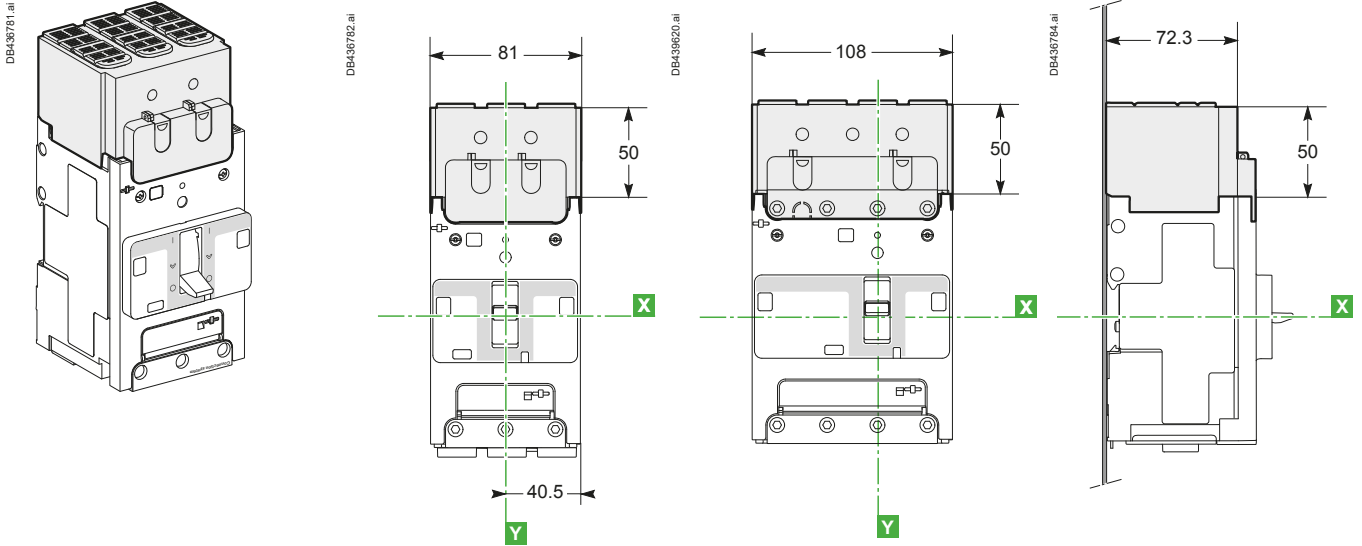

Interphase Barriers

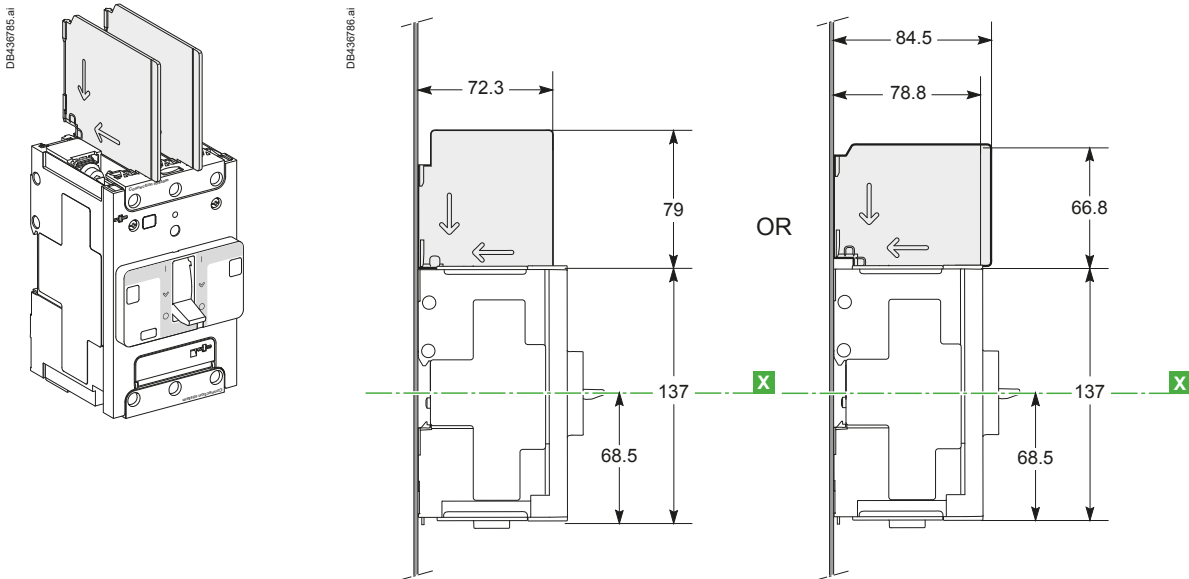

E

ComPacT NSXm Dimensions and Mounting

Circuit Breaker and Switch-Disconnecter

Rear Insulating Screens

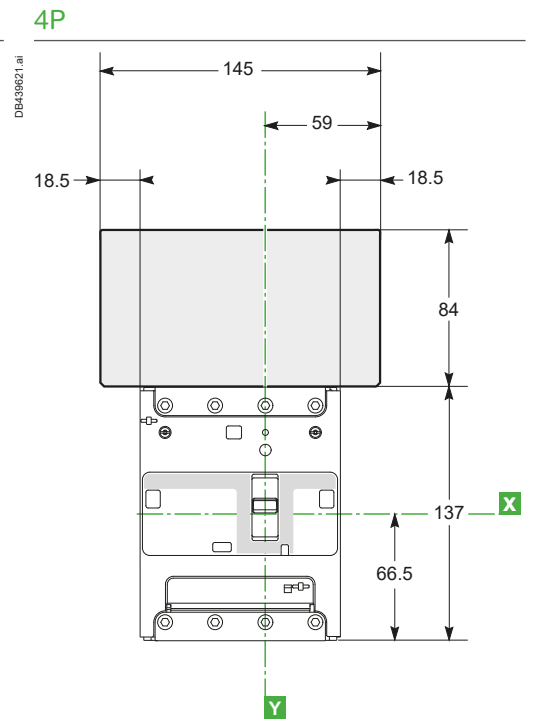
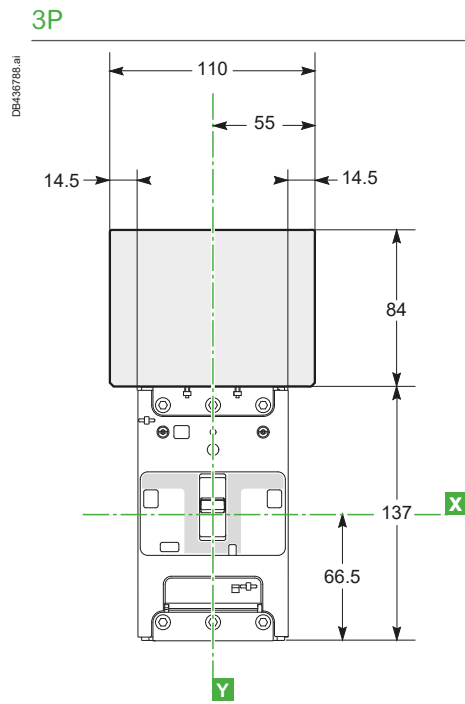
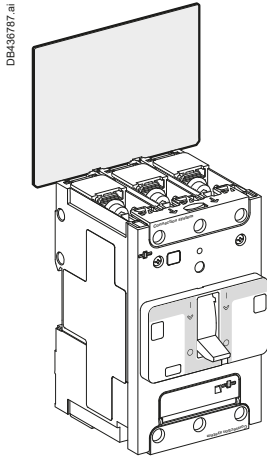

ComPacT NSXm Dimensions and Mounting

Circuit Breaker and Switch-Disconnecter

Mounting on Backplate

3P/4P

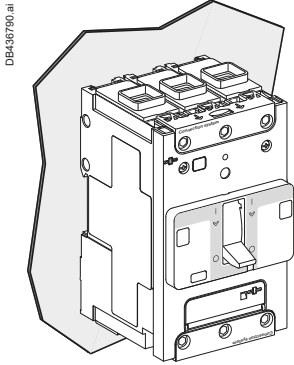

3P

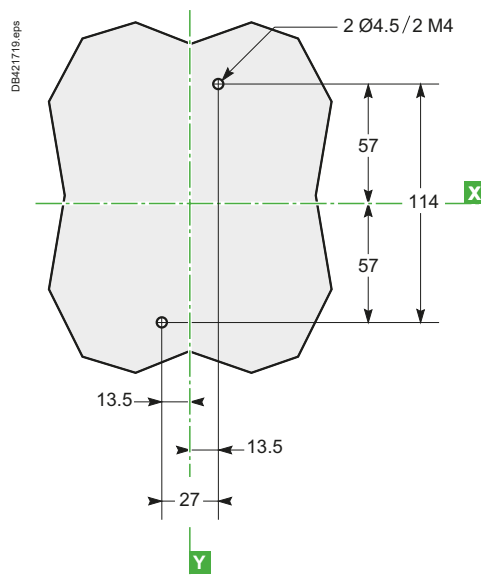

4P

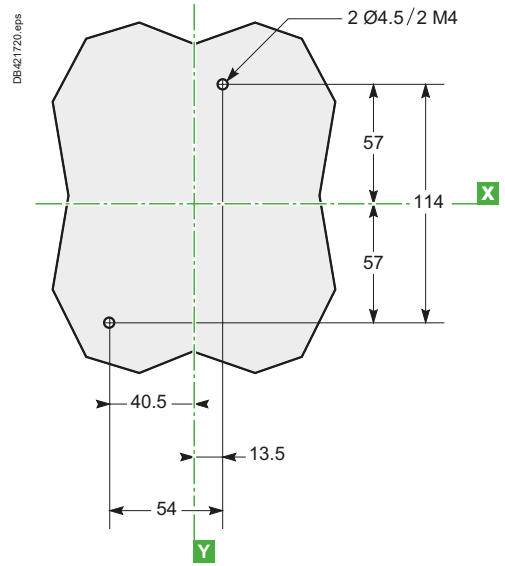

3P/4P Circuit Breaker with MicroLogic Vigi 4.1

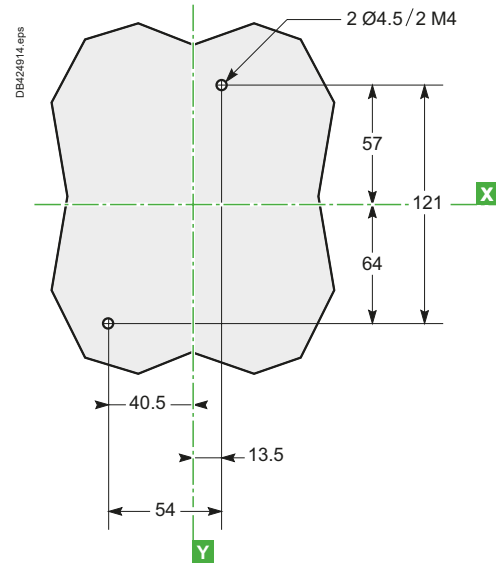

E

Mounting on DIN Rail

3P

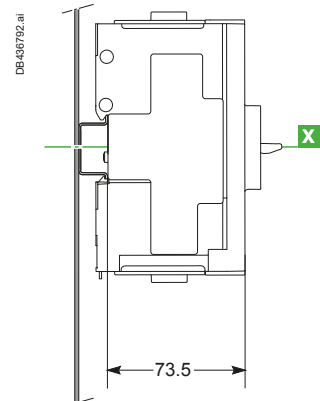
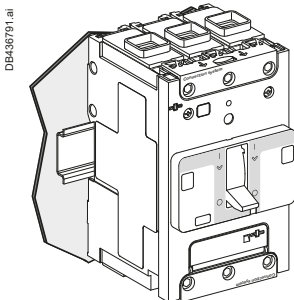

ComPacT NSXm Dimensions and Mounting

Circuit Breaker and Switch-Disconnect

Direct Rotary Handle

3P

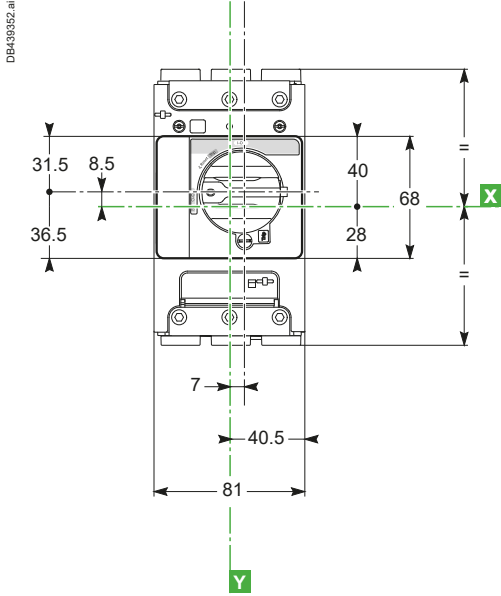

4P

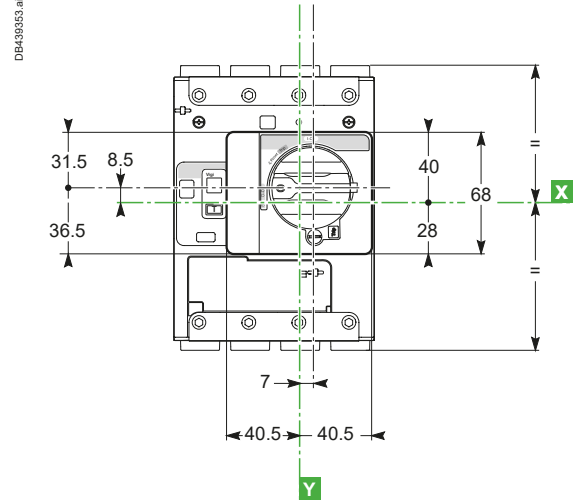

Side View

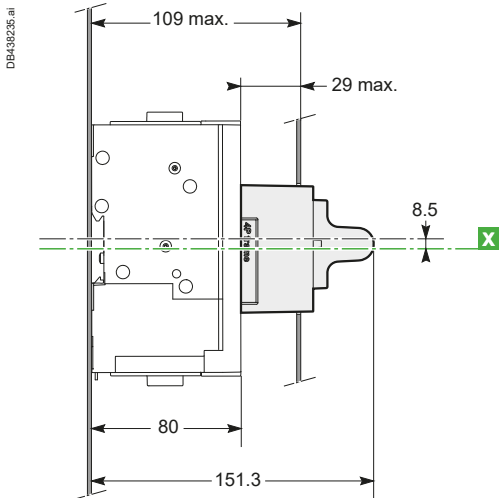

Door Cutout for 3P/4P

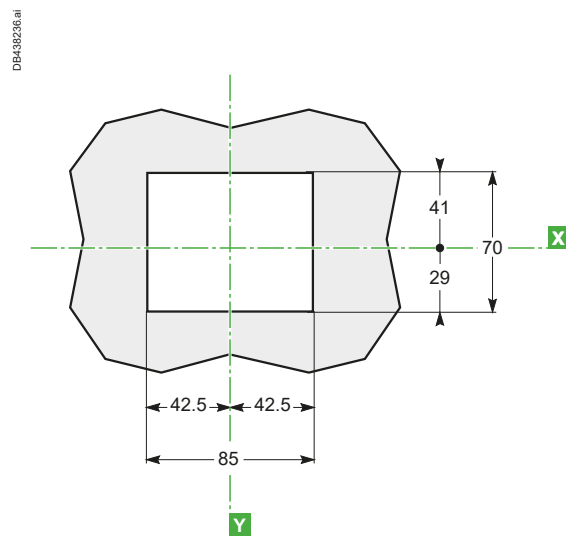

ComPacT NSXm Dimensions and Mounting

Circuit Breaker and Switch-Disconnecter

Extended Rotary Handle

3P

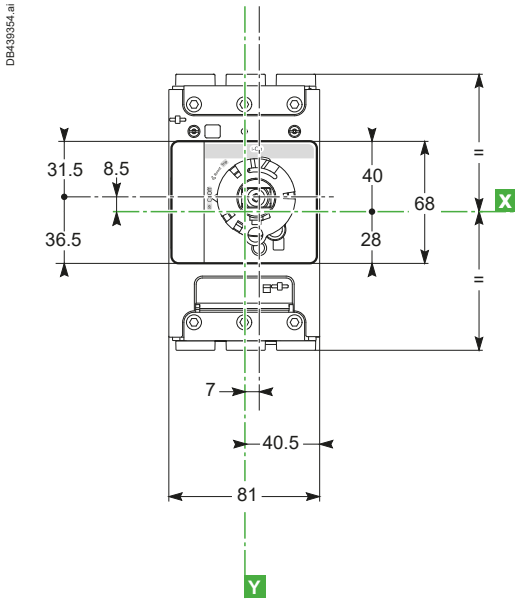

4P

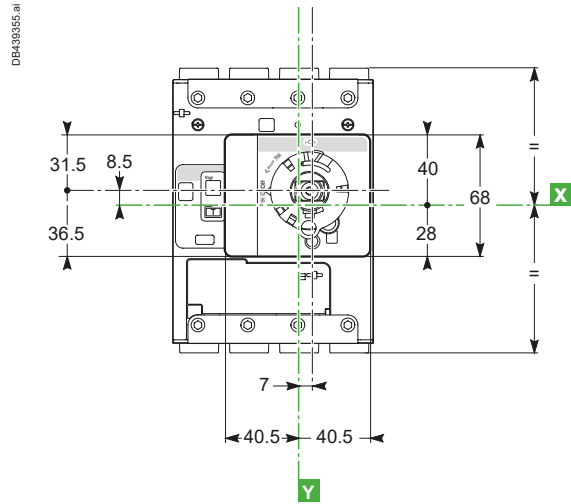

3P/4P

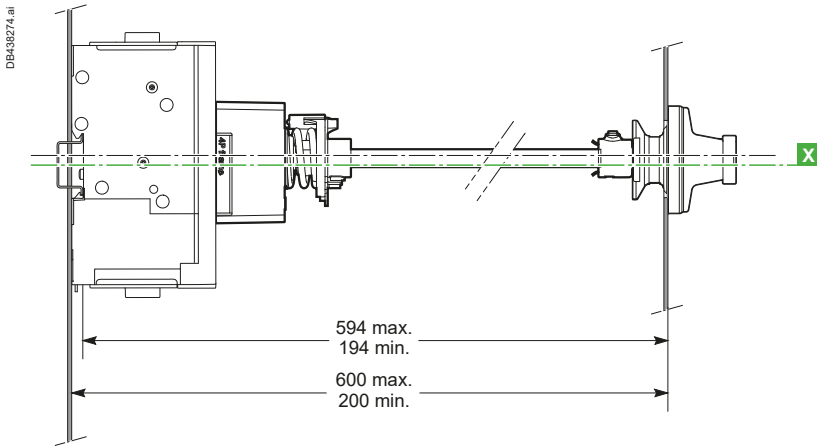

Dimensions and Front-Panel Cutout

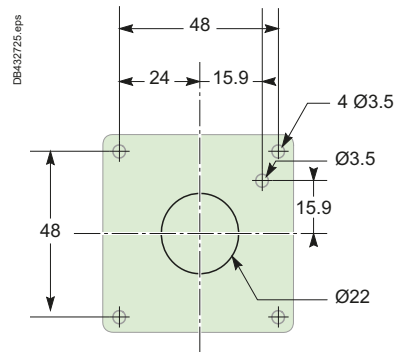
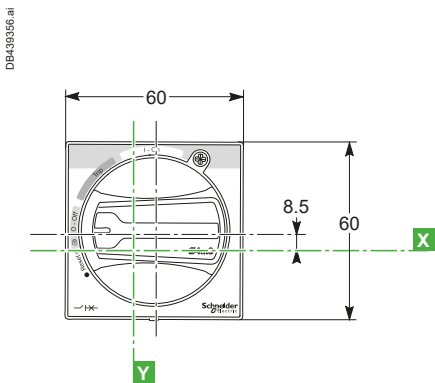

ComPacT NSXm Dimensions and Mounting Circuit Breaker and Switch-Disconnect

Side Rotary Handle

3P - Extended

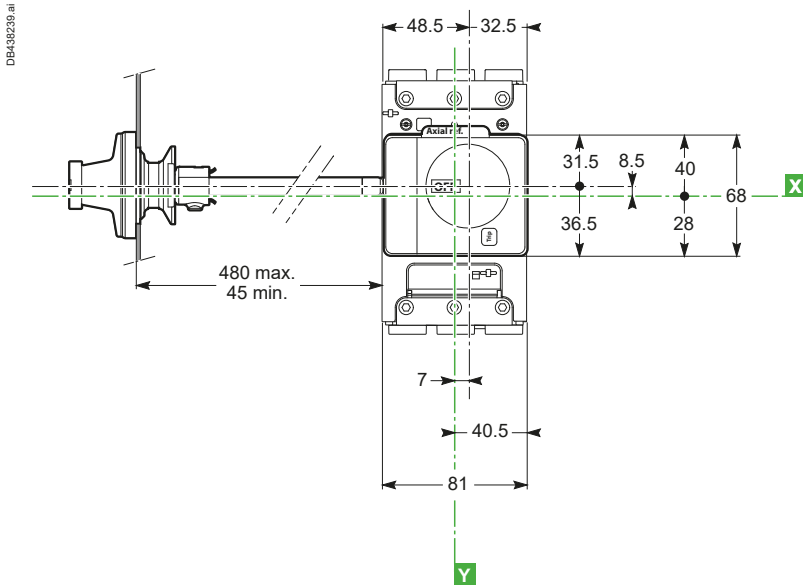

4P - Extended

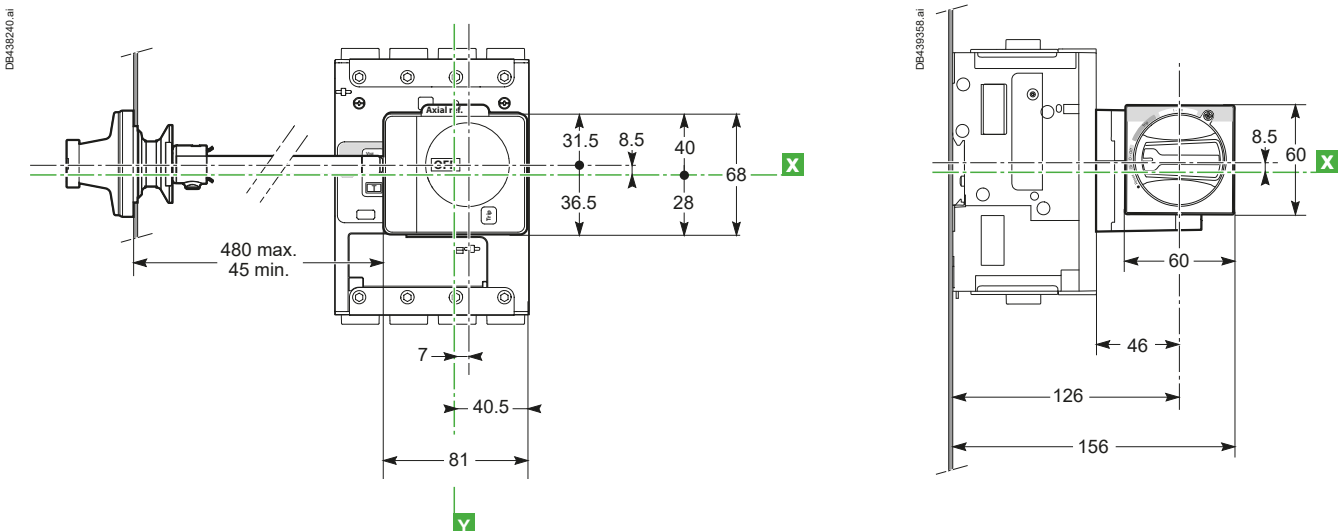

Dimensions Side Rotary Handle Cutout

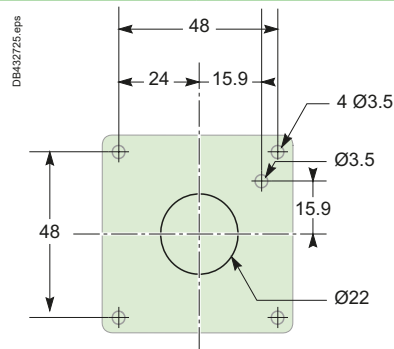
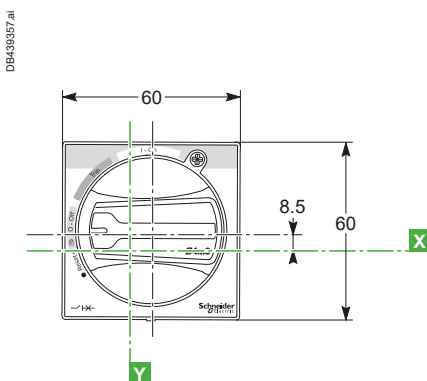

ComPacT NSXm Dimensions and Mounting

Circuit Breaker and Switch-Disconnecter

Connection with Accessories

Spreaders

3P

4P

Side View

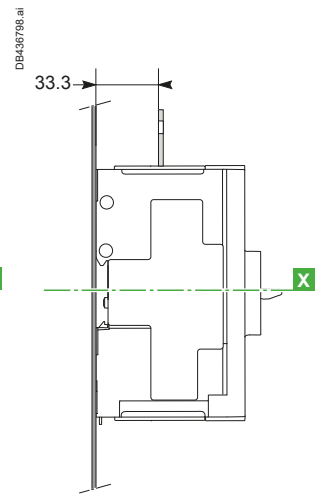
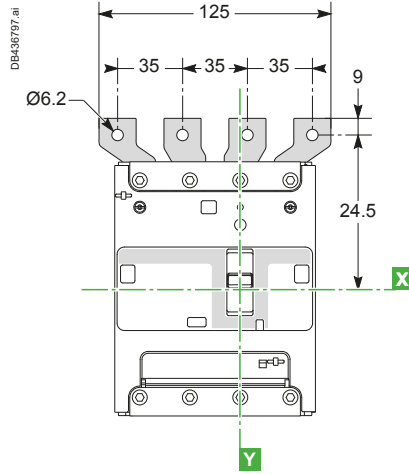
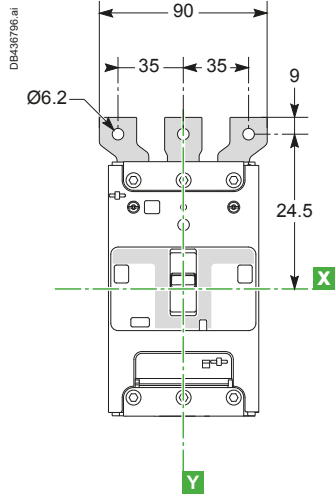
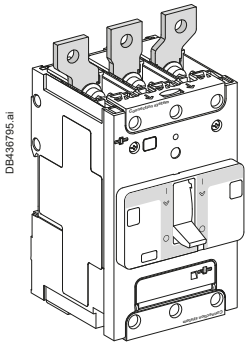

ComPacT NSX Dimensions and Mounting

ComPacT NSX100 to NSX250 Fixed Version, 1P-2P

Dimensions

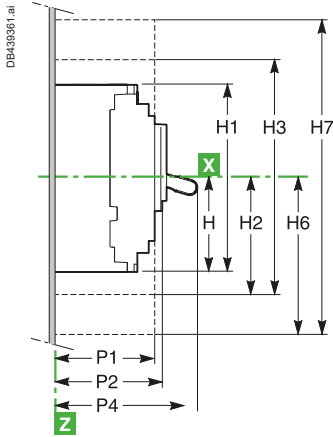

1 pole

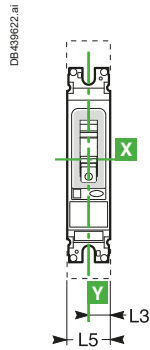

2 poles

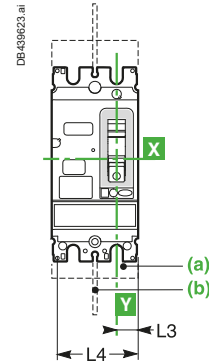

(a) Short terminal shields.
(b) Interphase barriers.

Mounting

On Backplate

1 pole

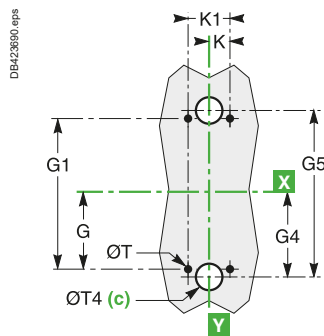

(c) For rear connection only.

2 poles

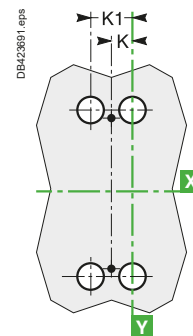

On Rails

1 pole

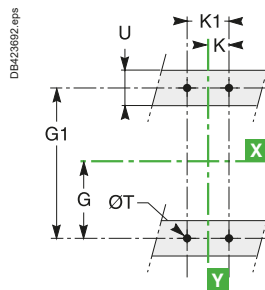

2 poles

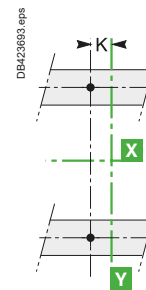

ComPacT NSX Dimensions and Mounting

ComPacT NSX100 to NSX250 Fixed Version, 1P-2P

Front-Panel Cutout

On Backplate

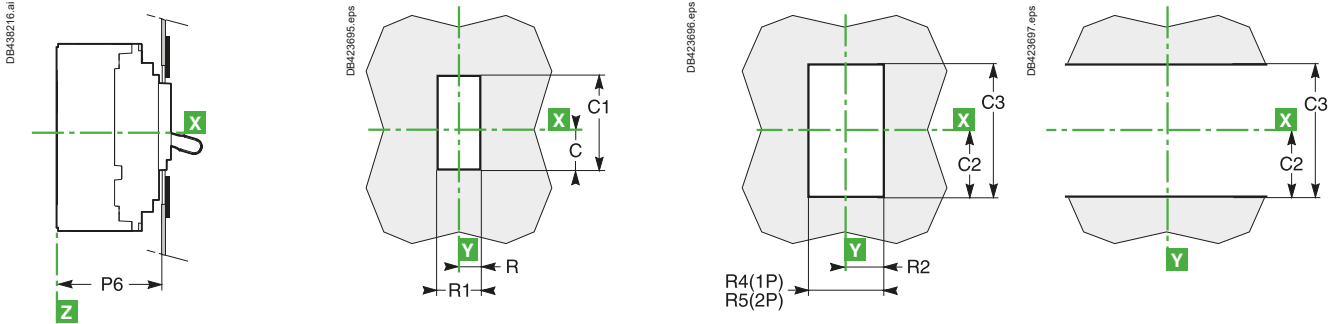

With Escutcheon

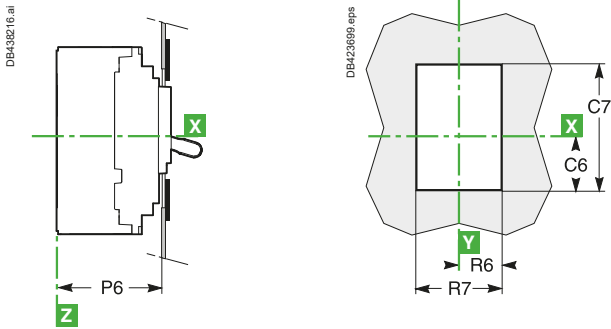

E

Dimensions (mm)

Type	C	C1	C2	C3	C6	C7	G	G1	G4	G5	H
NSX100/250	29	76	54	108	43	104	62.5	125	70	140	80.5
Type	H1	H2	H3	H4	H6	H7	K	K1	L3	L4	L5
NSX100/250	161	94	188	160.5	178.5	357	17.5	35	17.5	70	35
Type	P1	P2	P4	P5	P6	R	R1	R2	R4	R5	R6
NSX100/250	81	86	111	83	88	14.5	29	19	38	73	29
Type	R7	ØT	ØT4	U							
NSX100/250	58	6	22	≤ 32							

ComPacT NSX Dimensions and Mounting

ComPacT NSX100 to 630 Fixed Version

Dimensions

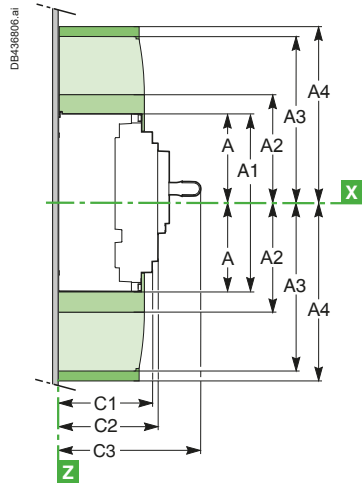
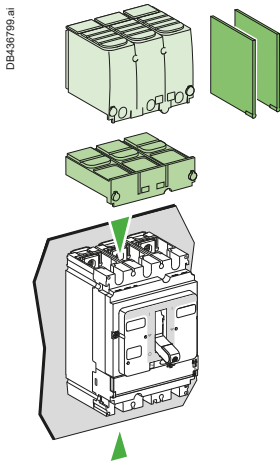

3P

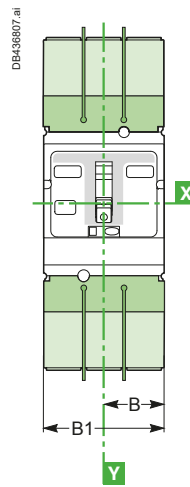

4P

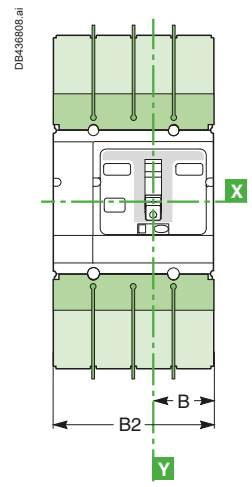

Interphase barriers.
 Long terminal shields (also available for NSX400/630 spreaders with 52.5 mm pitch:
 Short terminal shields.

B1 = 157.5 mm, B2 = 210 mm.

Mounting

NSX100 to 250

NSX400/630 [2]

NSX100 to 630 [2]

On Backplate

3P

3P

4P

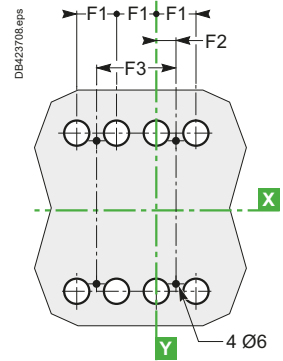
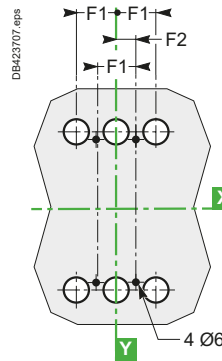
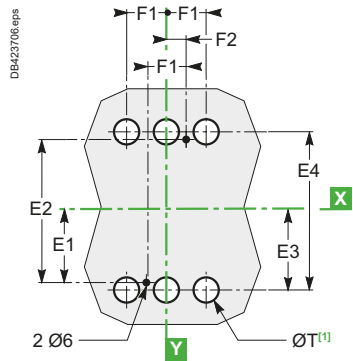
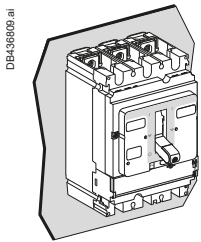

[2] For 630 A only:

[1] The ØT holes are required for rear connection only. For two-pole circuit breakers, the middle holes are not required.

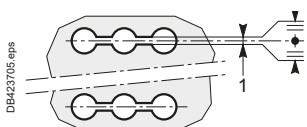

On Rails

3P

3P

4P

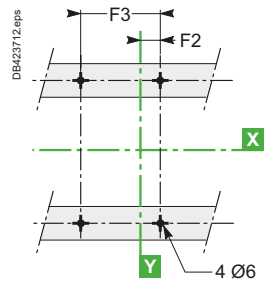
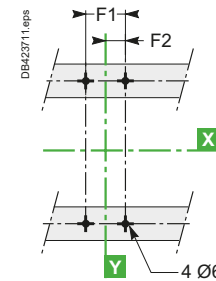
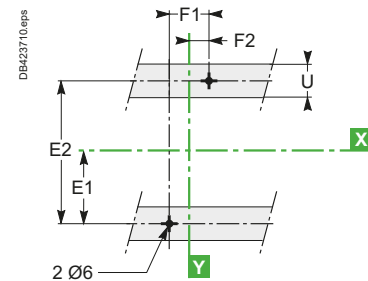
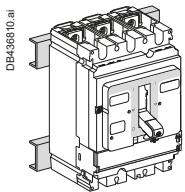

On DIN Rail with Adapter Plate (NSX100 to 250)

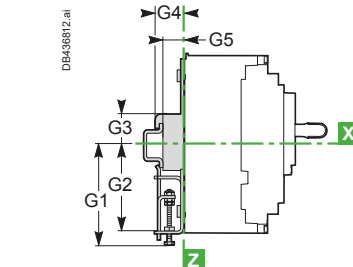
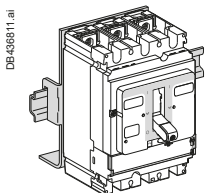

ComPacT NSX Dimensions and Mounting

ComPacT NSX100 to 630 VigiPacT Add-on Fixed Version

Dimensions

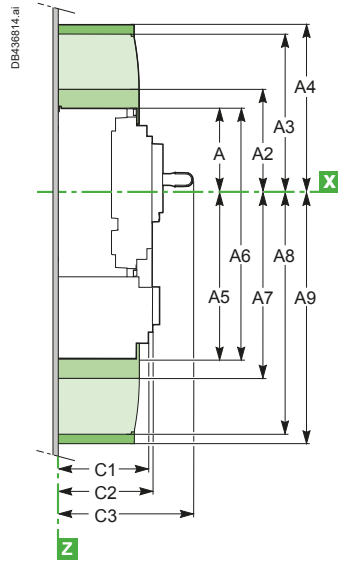
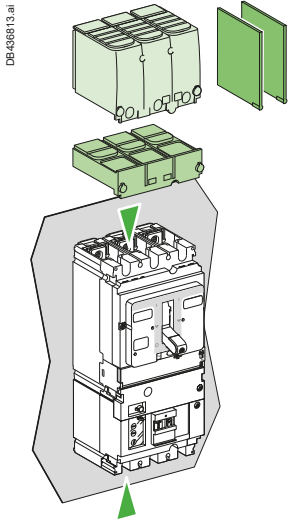

3/4P NSX100 to 250

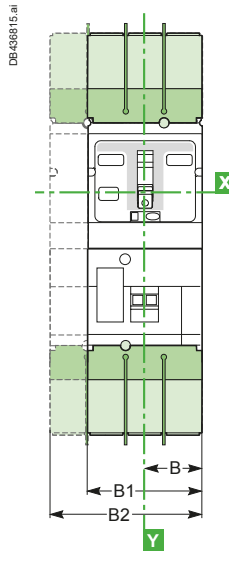

3/4P NSX400/630

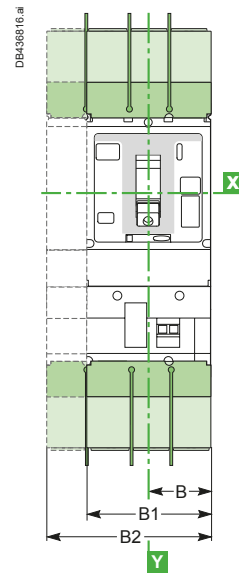

Mounting

On Backplate

NSX100 to 250

3P

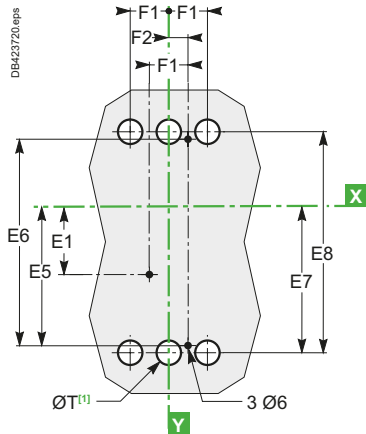
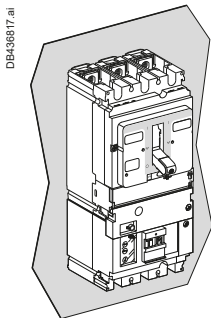

NSX400/630 [2]

3P

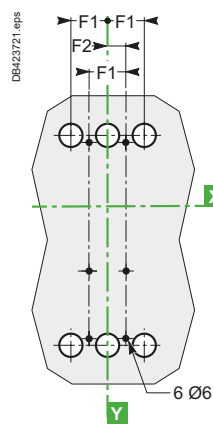

NSX100 to 630 [2]

4P

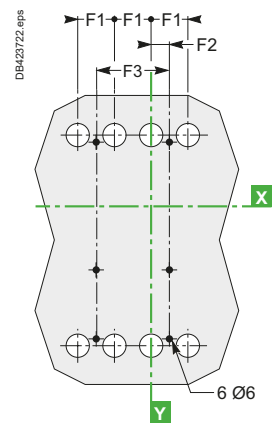

[2] For 630 A only:

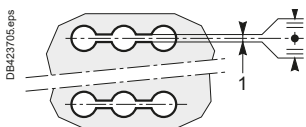

[1] The ØT holes are required for rear connection only.
For two-pole circuit breakers, the middle holes are not required.

On Rails

3P

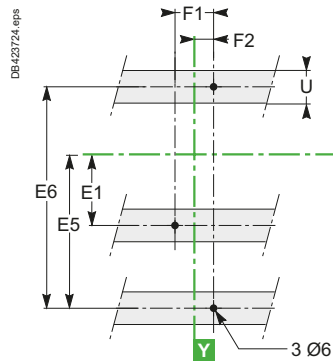
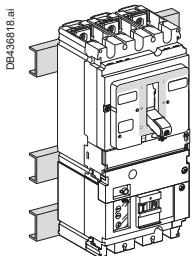

3P

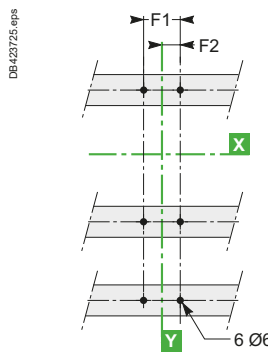

4P

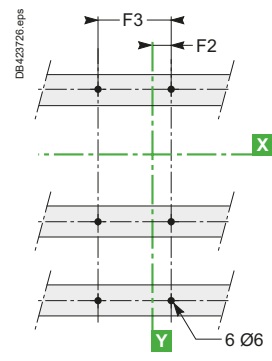

Type	A	A1	A2	A3	A4	A5	A6	A7	A8	A9	B	B1	B2	C1	C2	C3	E1
NSX100/160/250	80.5	161	94	145	178.5	155.5	236	169	220	253.5	52.5	105	140	81	86	126	62.5
NSX400/630	127.5	255	142.5	200	237	227.5	355	242.5	300	337	70	140	185	105	110	168	100
Type	E2	E3	E4	E5	E6	E7	E8	F1	F2	F3	G1	G2	G3	G4	G5	ØT	U
NSX100/160/250	125	70	140	137.5	200	145	215	35	17.5	70	95	75	13.5	23	17.5	24	≤ 32
NSX400/630	200	113.5	227	200	300	213.5	327	45	22.5	90	-	-	-	-	-	32	≤ 35

ComPacT NSX Dimensions and Mounting

ComPacT NSX100 to 630 Plug-in Version

Dimensions

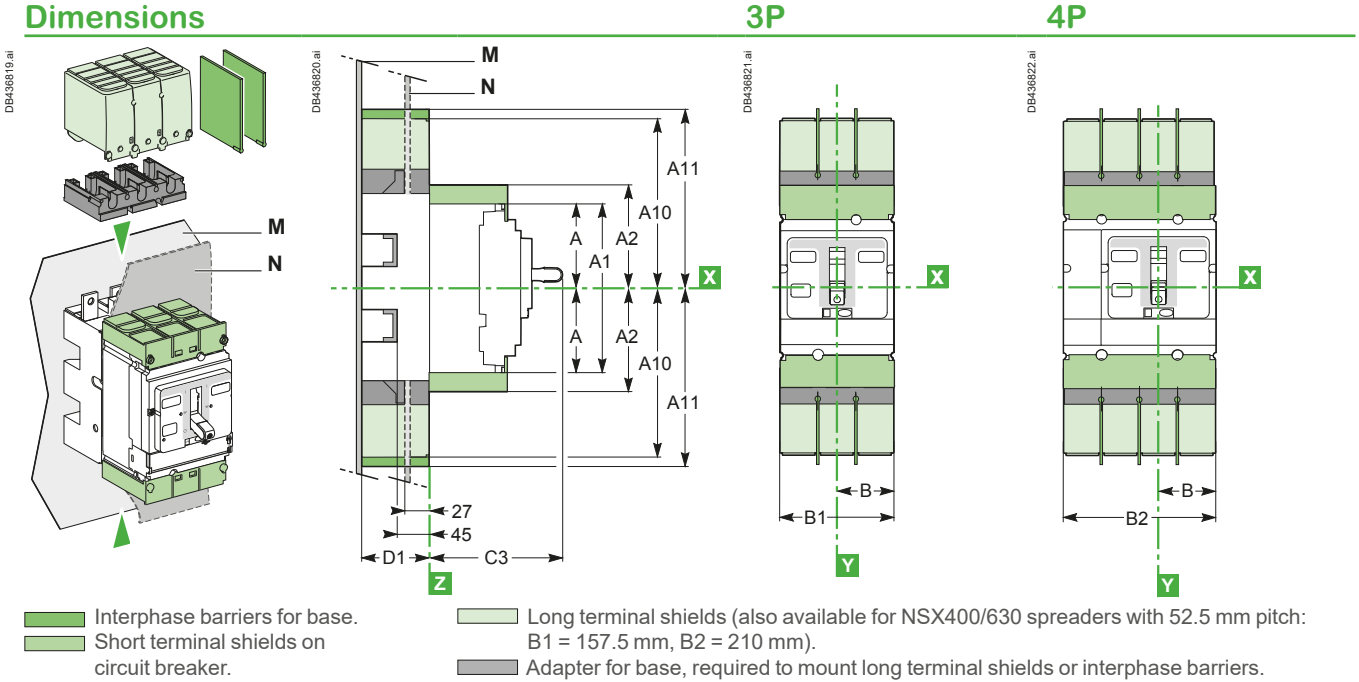

Mounting

Through Front Panel (N)

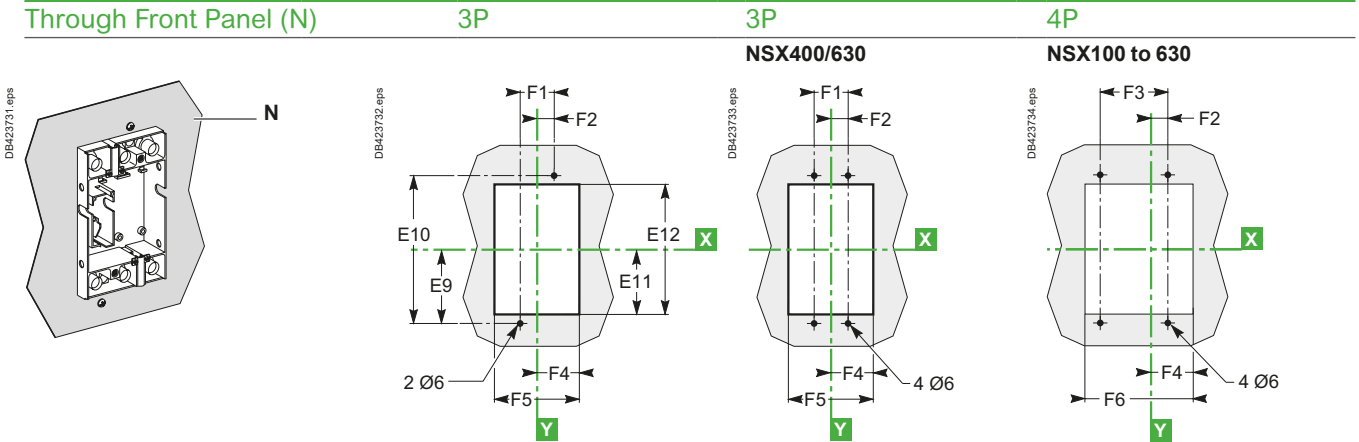

ComPacT NSX Dimensions and Mounting

ComPacT NSX100 to 630 Plug-in Version

On Backplate (M)

Front connection (an insulating screen is supplied with the base and must be fitted between the base and the backplate)

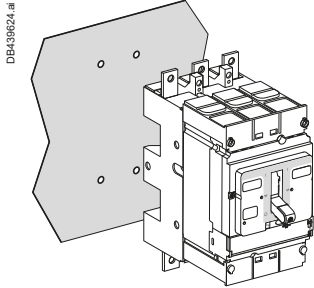

3P

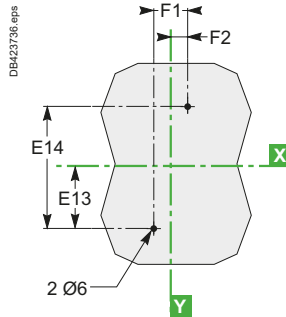

4P

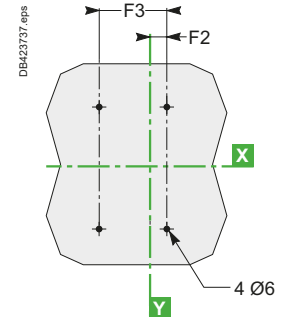

Connection by exterior-mounted rear connectors

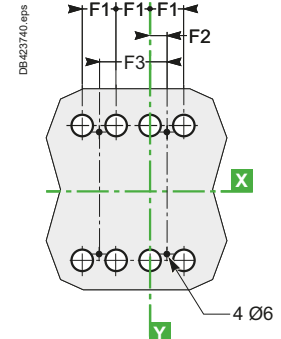
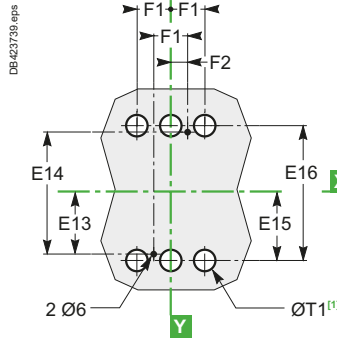
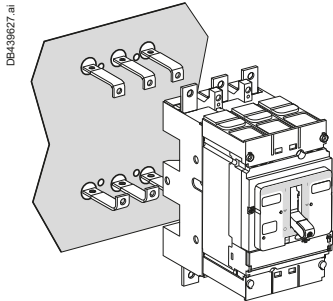

[1] The ØT1 holes are required for rear connection only (for two-pole circuit breakers, the middle holes are not required).

Connection by interior-mounted rear connectors

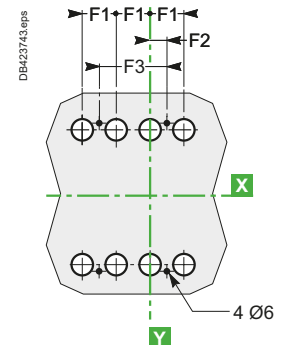
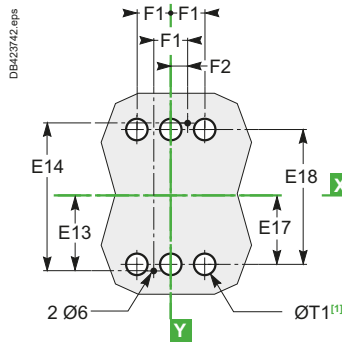
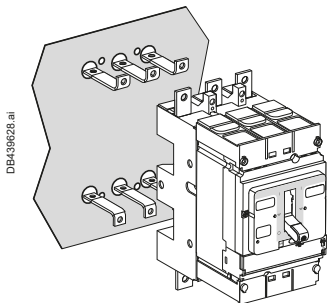

[1] The ØT1 holes are required for rear connection only (for two-pole circuit breakers, the middle holes are not required).

On Rails

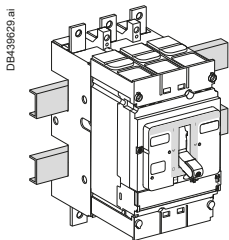

3P

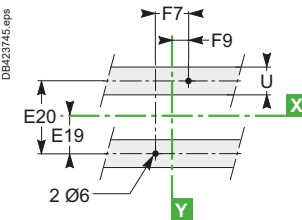

4P

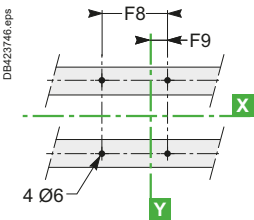

Type	A	A1	A2	A10	A11	B	B1	B2	C3	D1	E9	E10	E11	E12	E13	E14	E15
NSX100/160/250	80.5	161	94	175	210	52.5	105	140	126	75	95	190	87	174	77.5	155	79
NSX400/630	127.5	255	142.5	244	281	70	140	185	168	100	150	300	137	274	125	250	126
Type	E16	E17	E18	E19	E20	F1	F2	F3	F4	F5	F6	F7	F8	F9	ØT1	U	
NSX100/160/250	158	61	122	37.5	75	35	17.5	70	54.5	109	144	70	105	35	24	≤ 32	
NSX400/630	252	101	202	75	150	45	22.5	90	71.5	143	188	100	145	50	33	≤ 35	

ComPacT NSX Dimensions and Mounting

ComPacT NSX100 to 630 Withdrawable Version

Dimensions

3P

4P

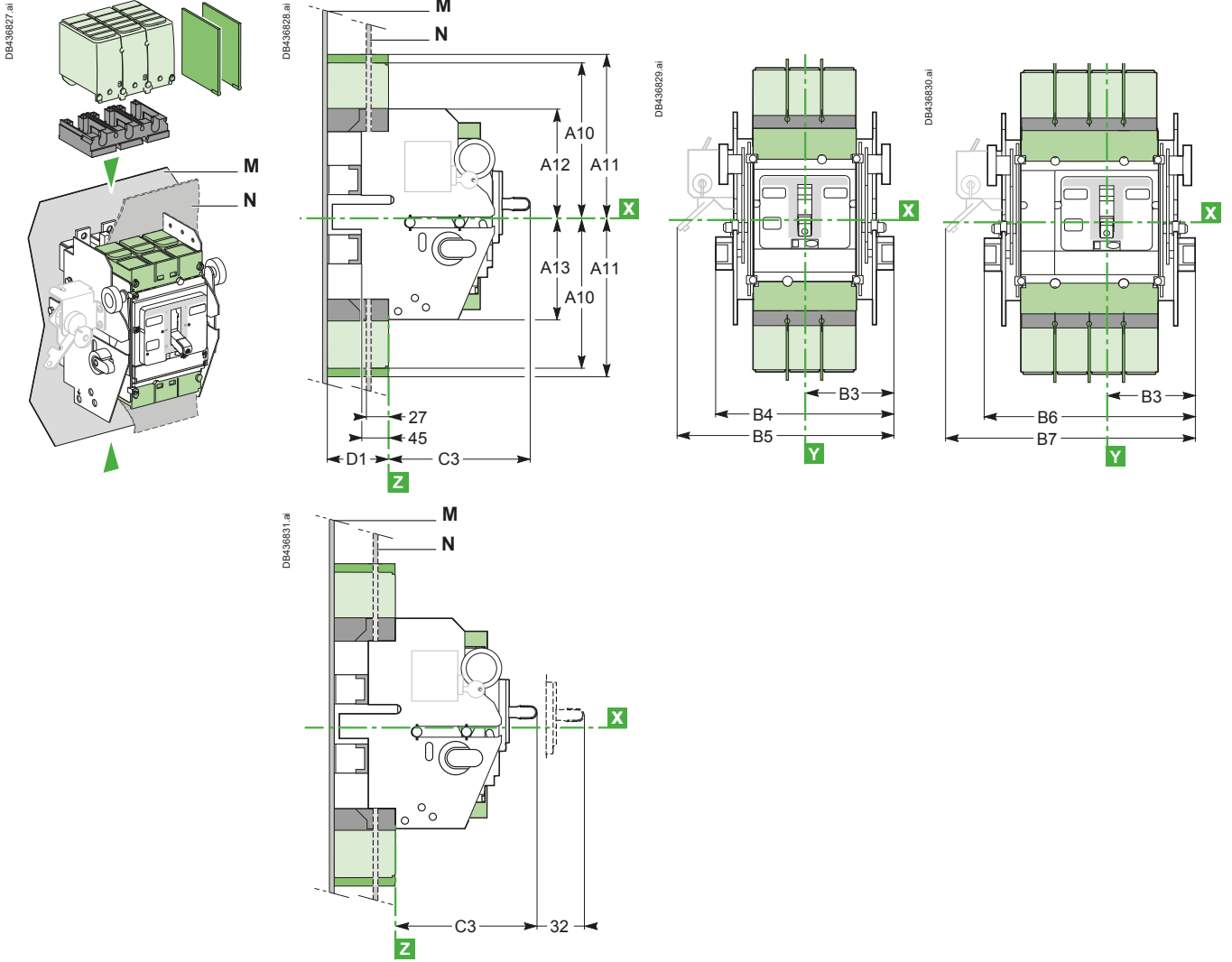

- Interphase barriers for base.
- Short terminal shields on circuit breaker.
- Long terminal shields.
- Adapter for base, required to mount long terminal shields or interphase barriers.

Mounting

Through Front Panel (N)

2/3P

3P

4P

NSX100 to 250

NSX400/630

NSX100 to 630

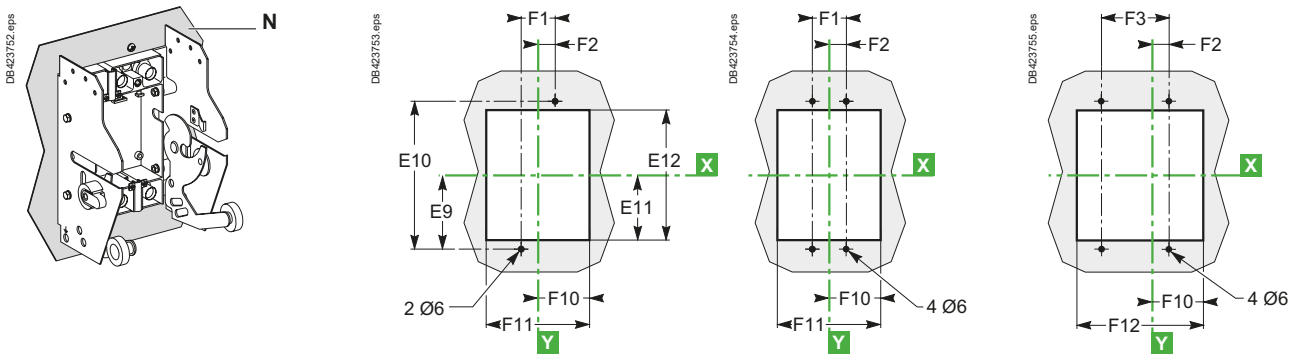

ComPacT NSX Dimensions and Mounting

ComPacT NSX100 to 630 Withdrawable Version

On Backplate (M)

3P

4P

Front connection (an insulating screen is supplied with the base and must be fitted between the base and the backplate)

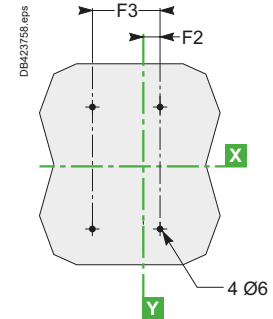
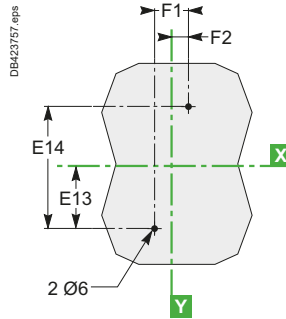
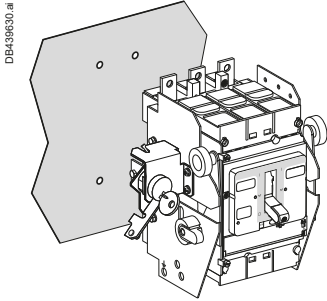

Connection by exterior-mounted rear connectors

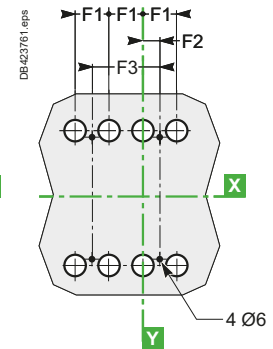
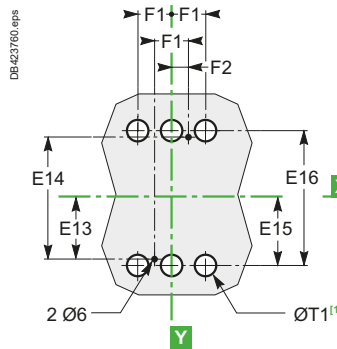
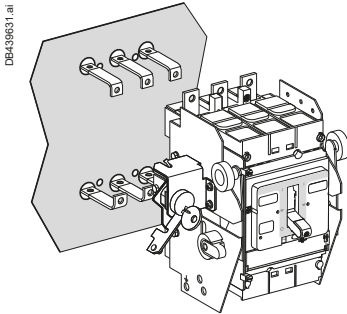

[1] The ØT1 holes are required for rear connection only (for two-pole circuit breakers, the middle holes are not required).

Connection by interior-mounted rear connectors

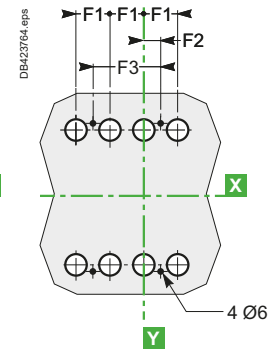
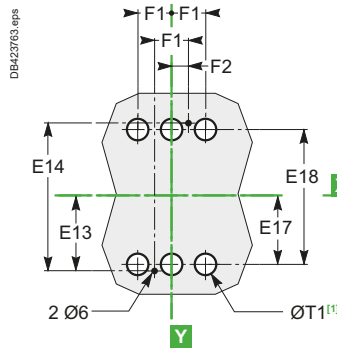
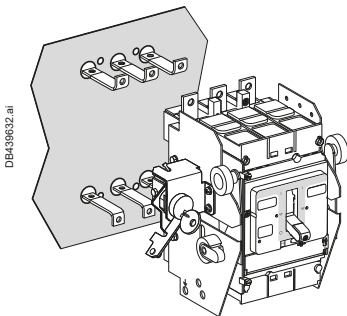

[1] The ØT1 holes are required for rear connection only (for two-pole circuit breakers, the middle holes are not required).

On Rails

3P

4P

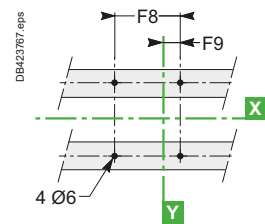
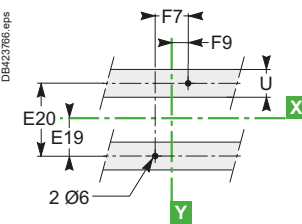
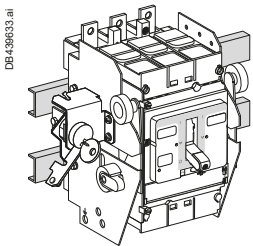

Type	A10	A11	A12	A13	B3	B4	B5	B6	B7	C3	D1	E9	E10	E11	E12	E13	E14
NSX100/160/250	175	210	106.5	103.5	92.5	185	216	220	251	126	75	95	190	87	174	77.5	155
NSX400/630	244	281	140	140	110	220	250	265	295	168	100	150	300	137	274	125	250
Type	E15	E16	E17	E18	E19	E20	F1	F2	F3	F7	F8	F9	F10	F11	F12	ØT1	U
NSX100/160/250	79	158	61	122	37.5	75	35	17.5	70	70	105	35	74	148	183	24	≤ 32
NSX400/630	126	252	101	202	75	150	45	22.5	90	100	145	50	91.5	183	228	33	≤ 35

ComPacT NSX Dimensions and Mounting

ComPacT NSX100 to 630 VigiPacT Add-on Plug-in and Withdrawable Versions

Dimensions - Plug-in Version

NSX100 to 250
3/4P

NSX400/630
3/4P

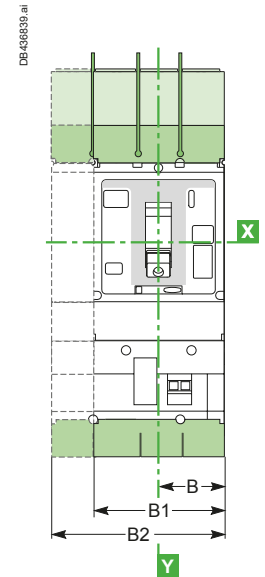
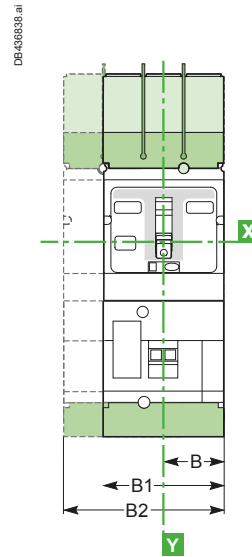
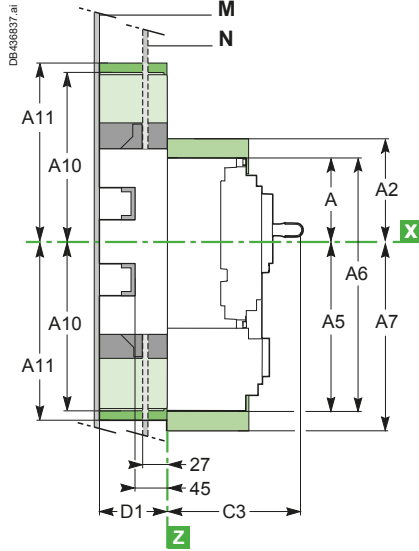
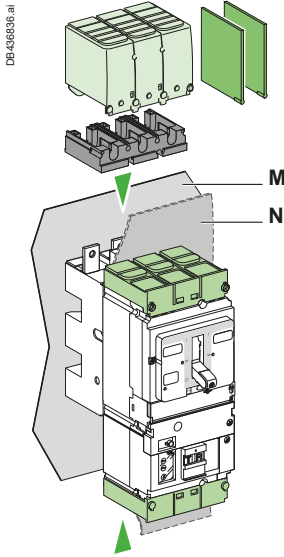

Interphase barriers for base.
Short terminal shields on circuit breaker.

Long terminal shields (also available for NSX400/630 spreaders with 52.5 mm pitch: B1 = 157.5 mm, B2 = 210 mm).
Adapter for base, required to mount long terminal shields or interphase barriers.

Dimensions - Withdrawable Version

NSX100 to 630
3P

4P

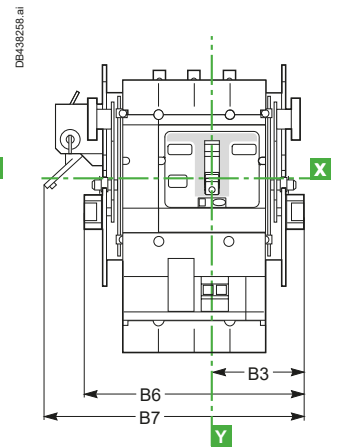
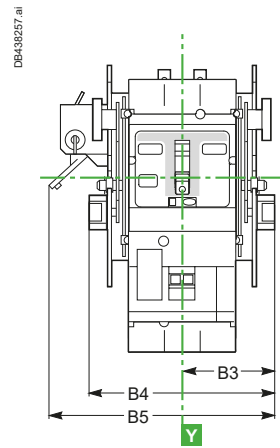
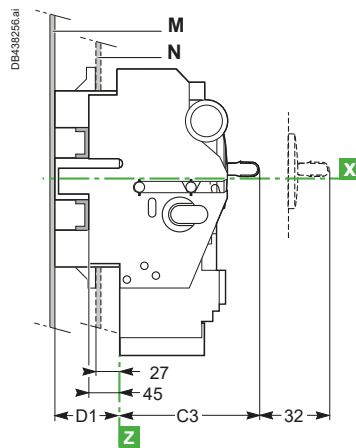
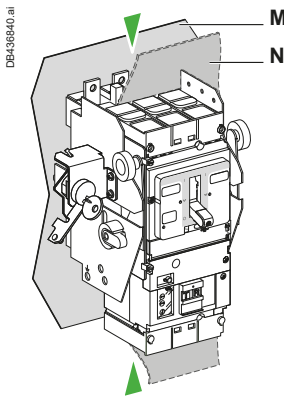

Mounting

Through front panel (N)

See ComPacT NSX100 to 630 plug-in version, [page E-37](#), or withdrawable version, [page E-39](#)

On backplate (M)

See ComPacT NSX100 to 630 plug-in version, [page E-38](#), or withdrawable version, [page E-40](#)

On rails

See ComPacT NSX100 to 630 plug-in version, [page E-38](#), or withdrawable version, [page E-40](#)

Type	A	A2	A5	A6	A7	A10	A11	B	B1	B2	B3	B4	B5	B6	B7	C3	D1
NSX100/160/250	80.5	94	155.5	236	169	175	210	52.5	105	140	92.5	185	216	220	251	126	75
NSX400/630	127.5	142.5	227.5	355	242.5	244	281	70	140	185	110	220	250	265	295	168	100

ComPacT NSX Dimensions and Mounting

Visu Function for ComPacT NSX100 to 250 Fixed Version

Dimensions - Combination with ComPacT INV100 to 250

3P

4P

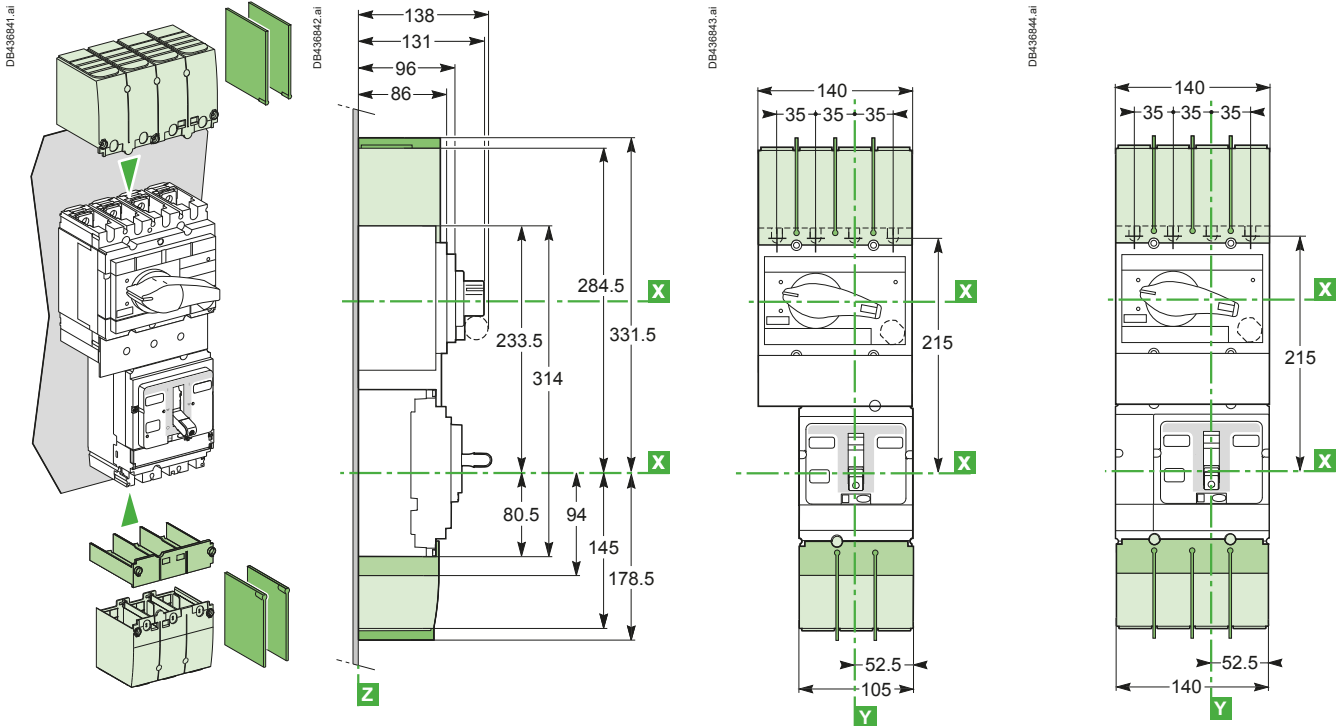

E

- Interphase barriers.
- Short terminal shields.
- Long terminal shields.

Mounting On Rails or Backplate

3P

4P

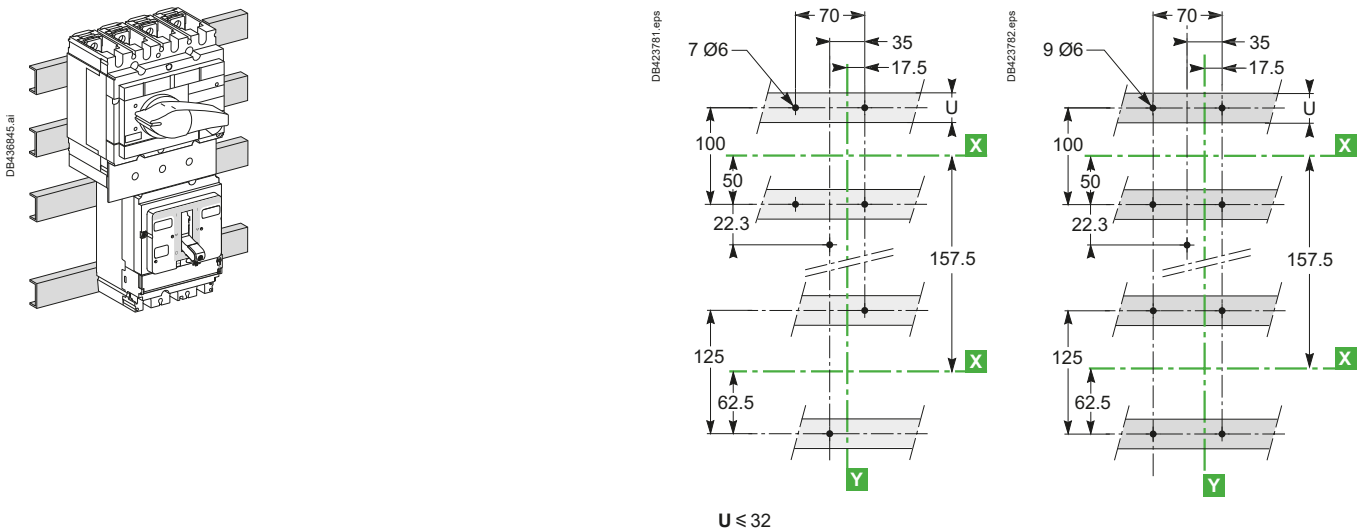

ComPacT NSX Dimensions and Mounting

Visu Function for ComPacT NSX400/630 Fixed Version

Dimensions - Combination with ComPacT INV400 to 630

3P

4P

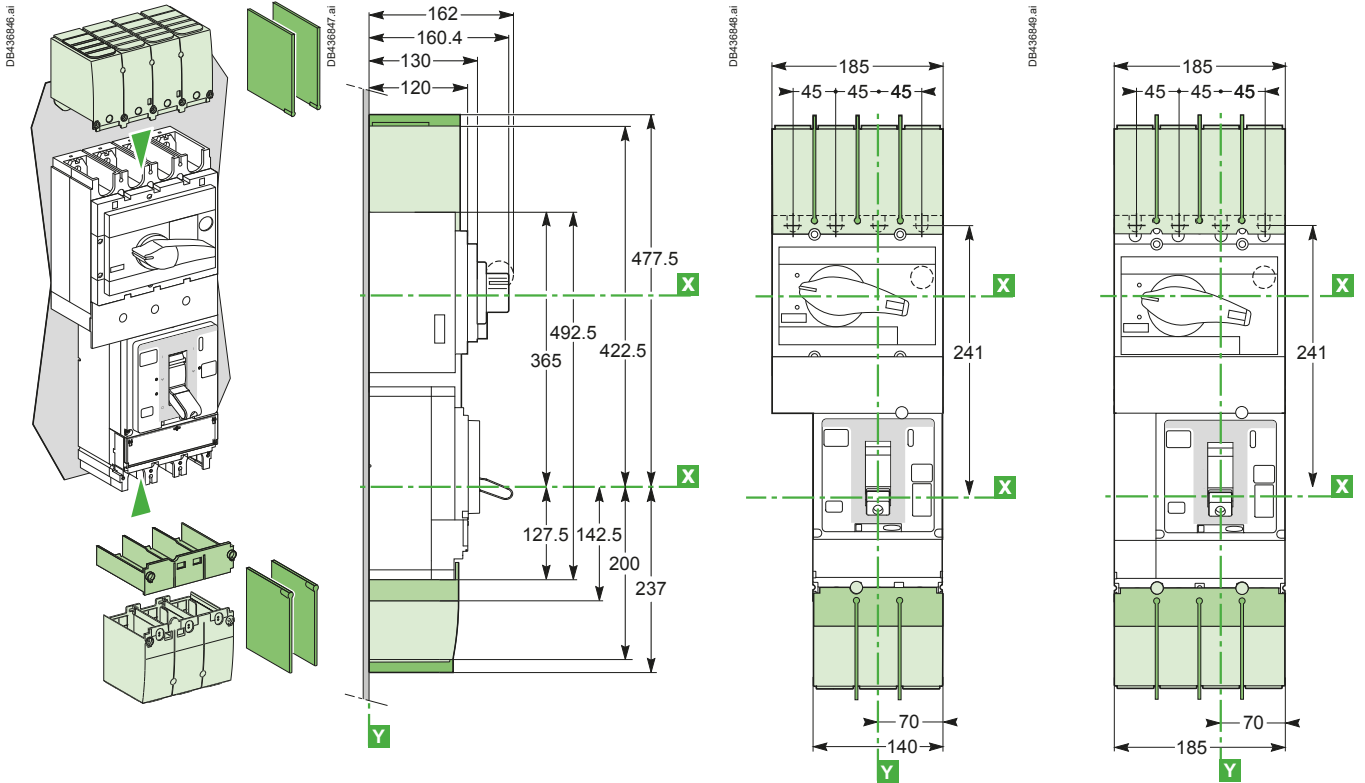

- Interphase barriers for base.
- Short terminal shields.
- Long terminal shields.

Mounting

On Rails or Backplate

3P

4P

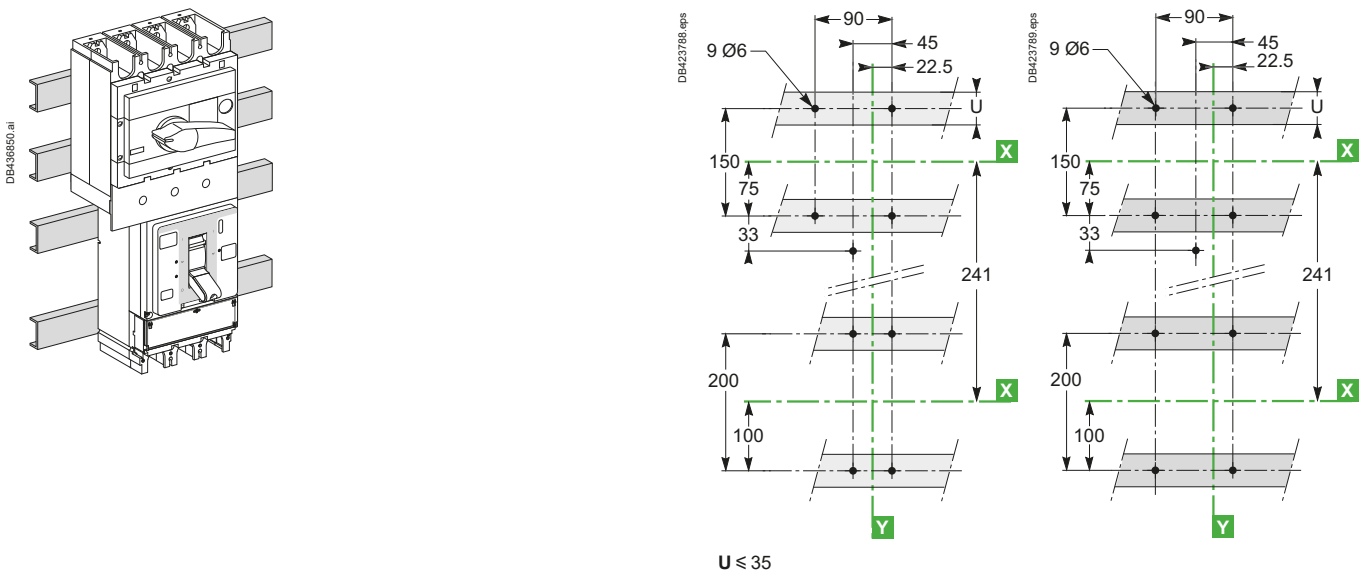

ComPacT NSX Dimensions and Mounting

Motor Mechanism Module for ComPacT NSX100 to 630

Dimensions

3P

4P

Fixed Circuit Breaker

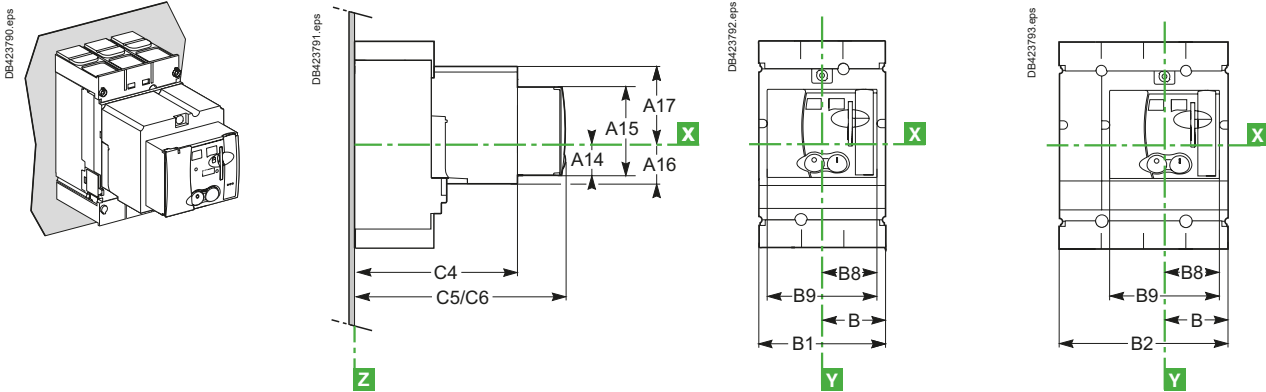

C5: without keylock
C6: with keylock

Plug-in Circuit Breaker

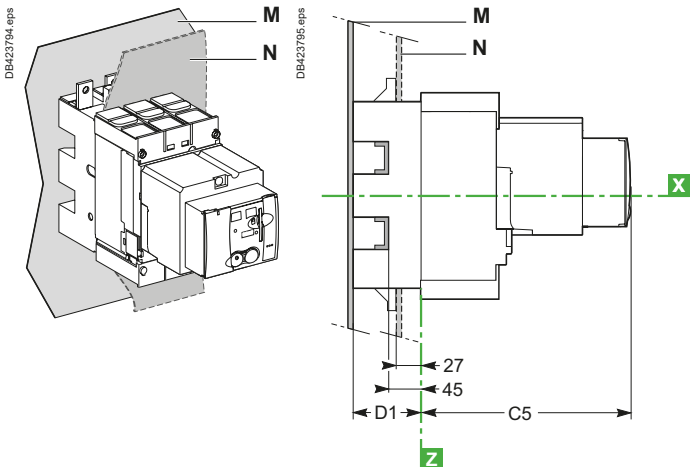

E

Withdrawable Circuit Breaker

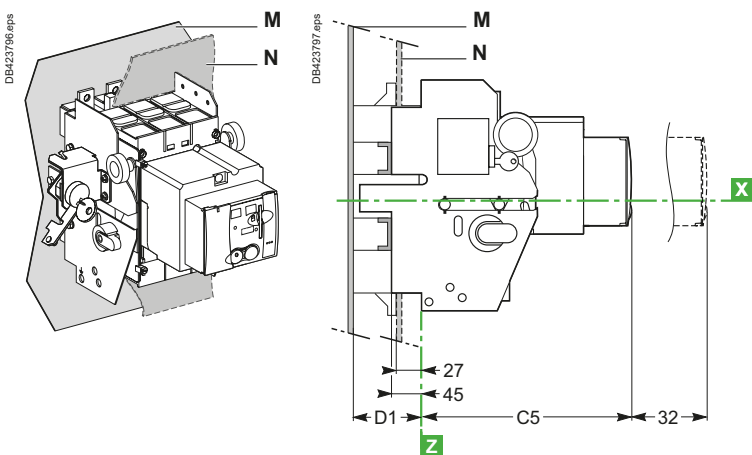

Type	A14	A15	A16	A17	B	B1	B2	B8	B9	C4	C5	C6	D1
NSX100/160/250	27.5	73	34.5	62.5	52.5	105	140	45.5	91	143	182	209.5	75
NSX400/630	40	123	52	100	70	140	185	61.5	123	215	256	258	100

ComPacT NSX Dimensions and Mounting

Direct Rotary Handle for ComPacT NSX100 to 630

Dimensions

3P

4P

Fixed Circuit Breaker

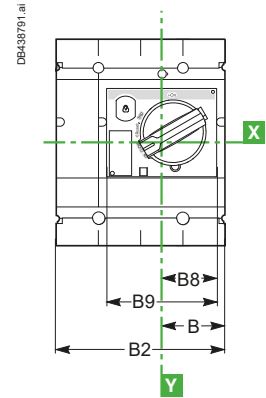
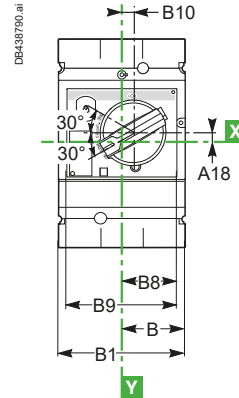
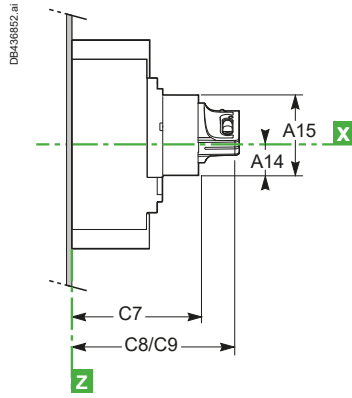
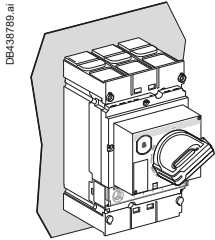

C8: without keylock
C9: with keylock

Plug-in Circuit Breaker

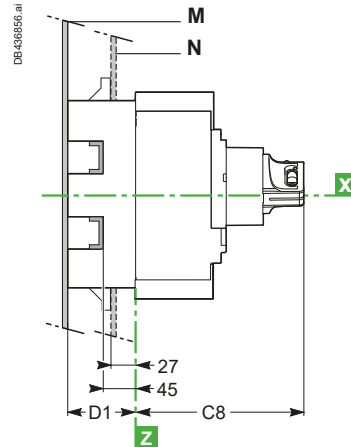
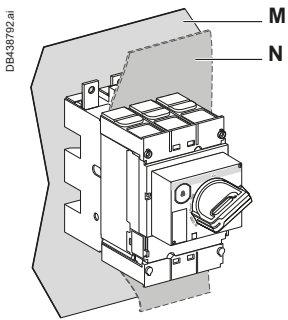

Withdrawable Circuit Breaker

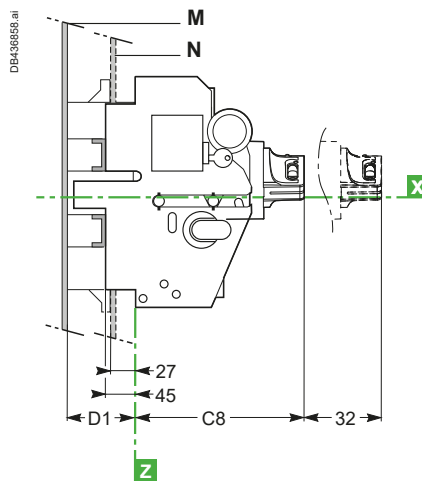
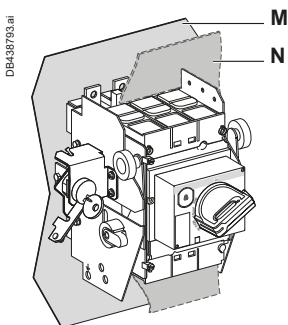

Type	A14	A15	A18	B	B1	B2	B8	B9	B10	C7	C8	C9	D1
NSX100/160/250	27.5	73	9	52.5	105	140	45.5	91	9.25	121	158.5	167.5	75
NSX400/630	40	123	24.6	70	140	185	61.5	123	5	145	182.5	191.5	100



ComPacT NSX Dimensions and Mounting

MCC and CNOMO Type Direct Rotary Handles for ComPacT NSX100 to 630 Fixed Version

Dimensions

MCC Type Direct Rotary Handle

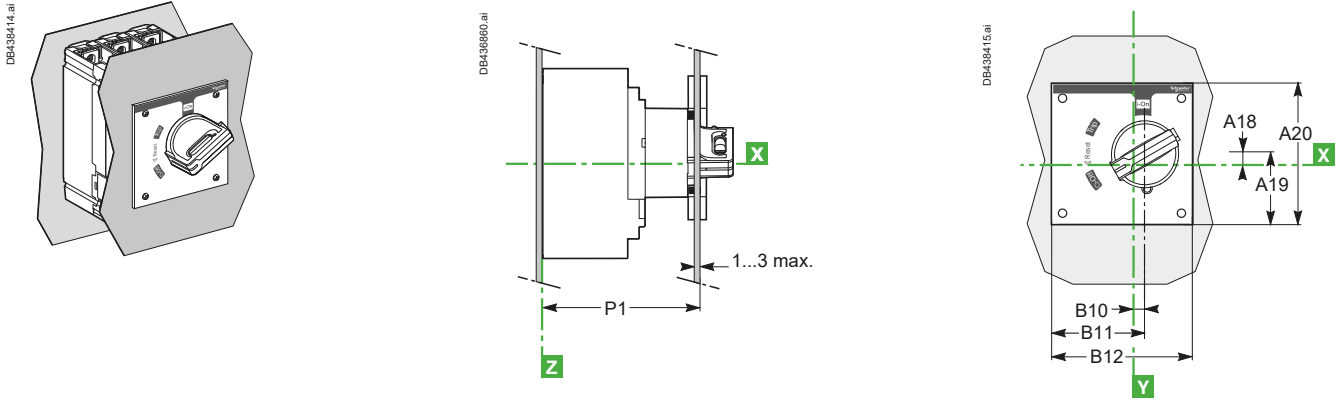

CNOMO Type Direct Rotary Handle

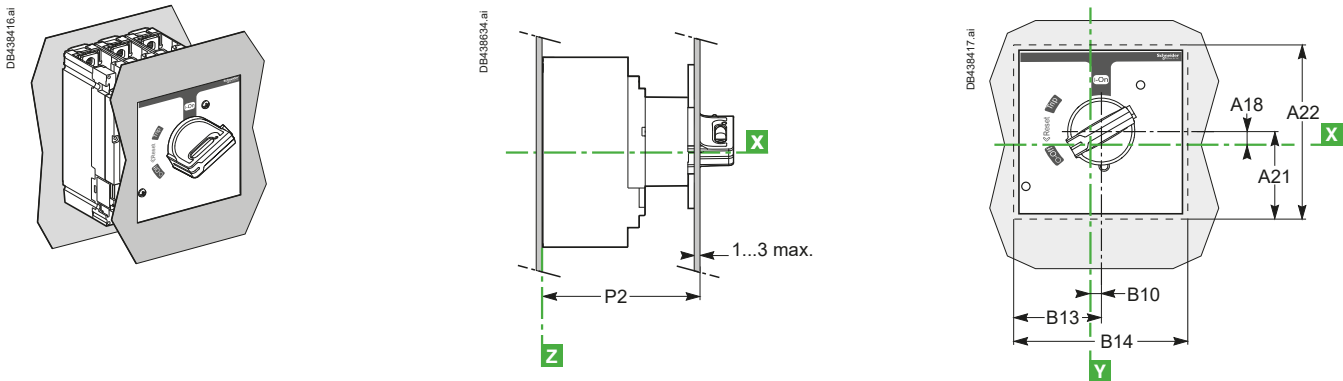

Front-Panel Cutout

NSX100 to 250

NSX400/630

MCC Type Direct Rotary Handle

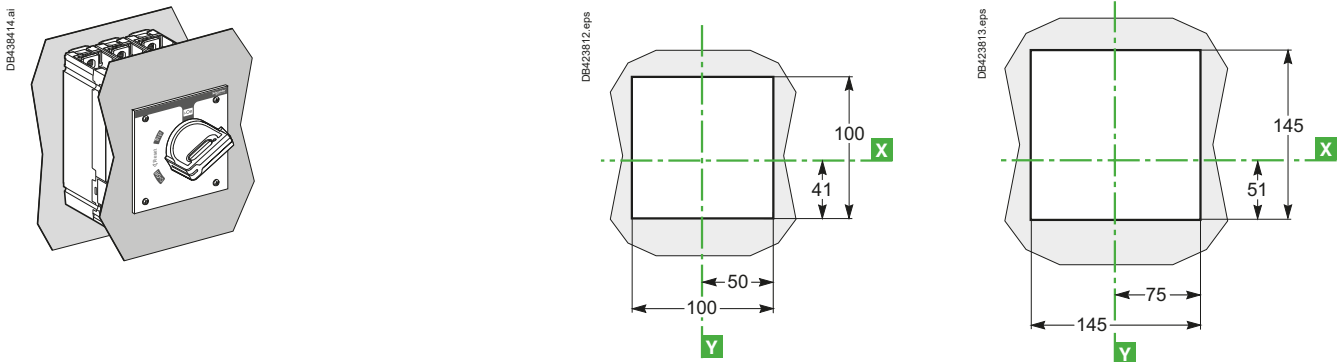

CNOMO Type Direct Rotary Handle

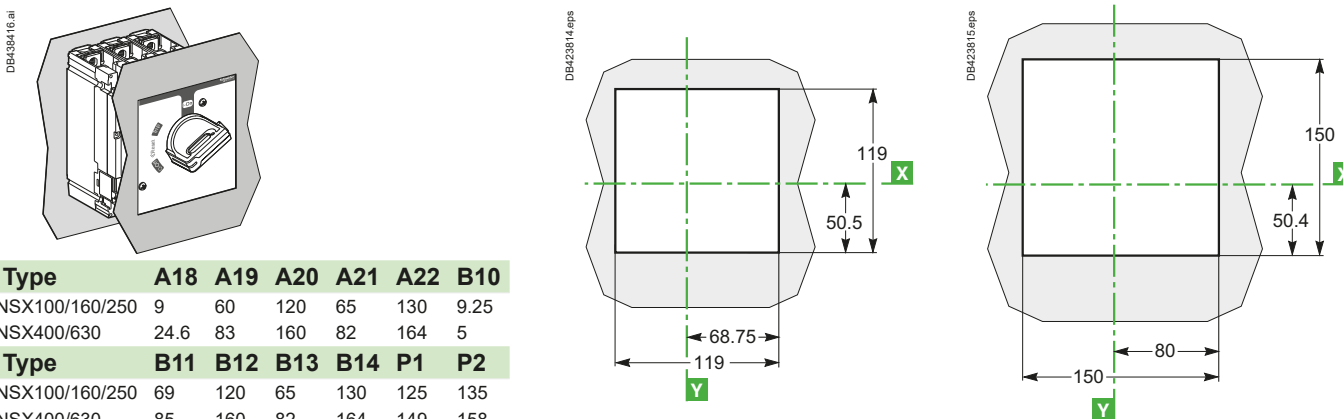

Type	A18	A19	A20	A21	A22	B10
NSX100/160/250	9	60	120	65	130	9.25
NSX400/630	24.6	83	160	82	164	5
Type	B11	B12	B13	B14	P1	P2
NSX100/160/250	69	120	65	130	125	135
NSX400/630	85	160	82	164	149	158

ComPacT NSX Dimensions and Mounting

Extended Rotary Handle for ComPacT NSX100 to 630

Dimensions

Fixed and Plug-in Circuit Breakers

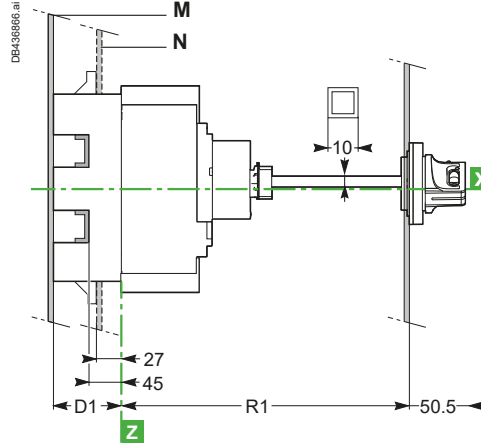
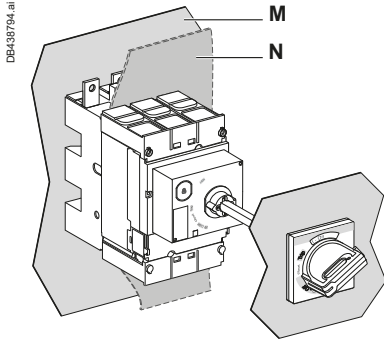

Cutout for shaft (mm)

Type	R1
NSX100/160/250	min. 171 max. 600
NSX400/630	min. 195 max. 600

Withdrawable Circuit Breaker

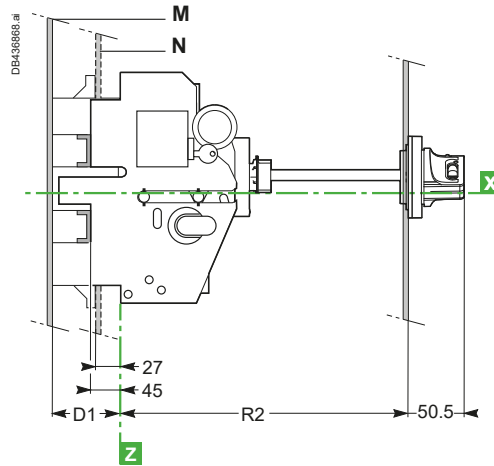
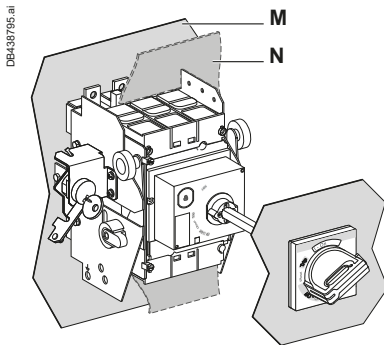

Cutout for shaft (mm)

Type	R2
NSX100/160/250	min. 248 max. 600
NSX400/630	min. 272 max. 600

Dimensions and Front-Panel Cutout

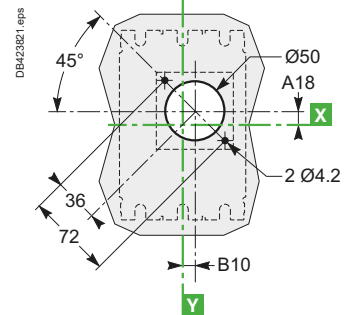
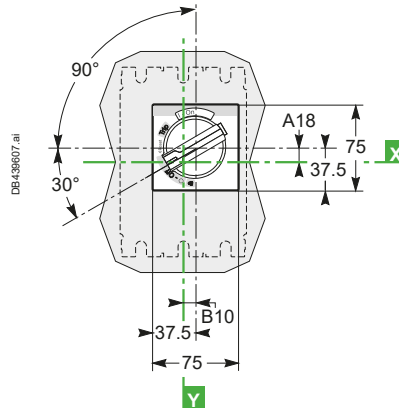

Type	A18	B10	D1
NSX100/160/250	9	9.25	75
NSX400/630	24.6	5	100



ComPacT NSX Dimensions and Mounting

Indication and Measurement Modules for ComPacT NSX100 to 630 Fixed Version

Dimensions of Circuit Breaker with Current-Transformer/PowerLogic PowerTag NSX Module

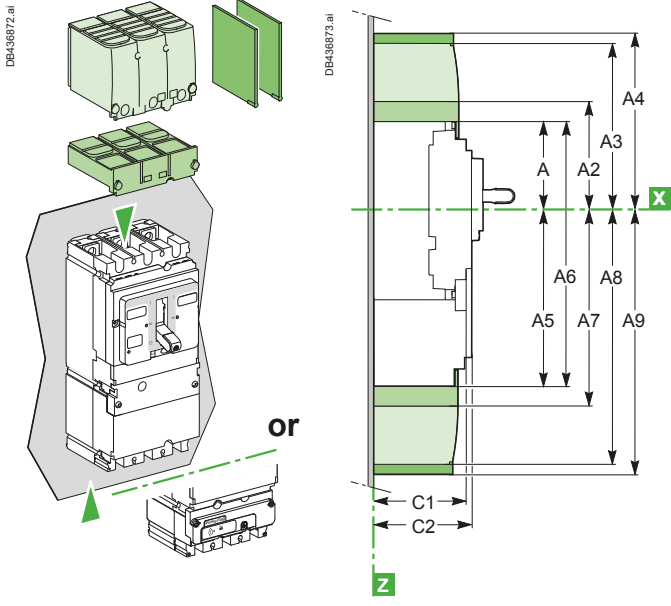

Mounting

On Backplate

NSX100 to 250 NSX400/630

2/3P

3P

NSX100 to 630

4P

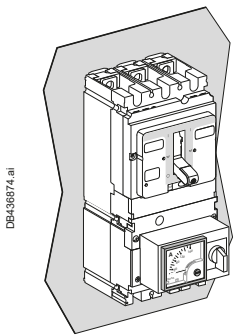

[1] The ØT holes are required for rear connection only. For two-pole circuit breakers, the middle holes are not required.

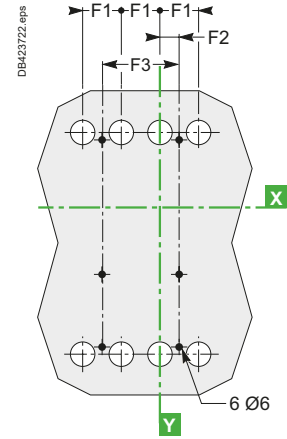
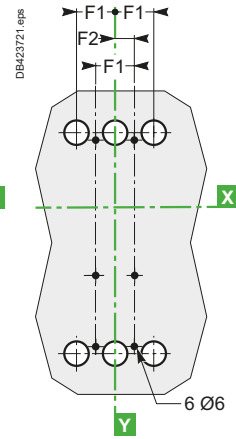
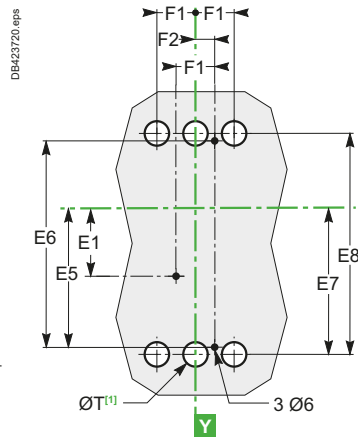

On Rails

2/3P

3P

4P

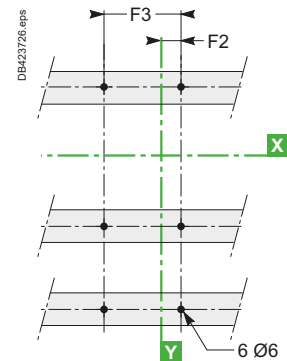
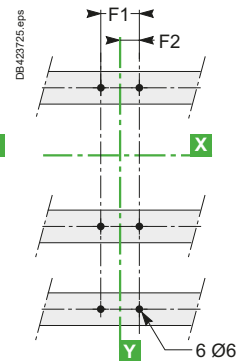
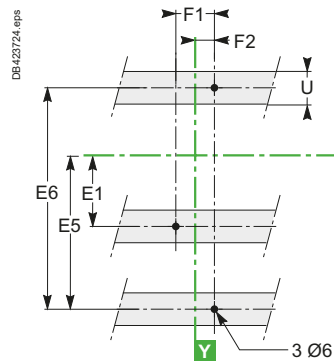
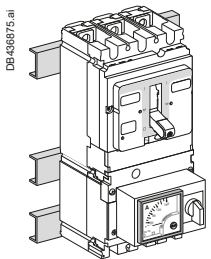

Type	A	A2	A3	A4	A5	A6	A7	A8	A9	C1	C2	C11	E1	E5	E6	E7	E8	F1
NSX100/160/250	80.5	94	145	178.5	155.5	236	169	220	253.5	81	86	137	62.5	137.5	200	145	215	35
NSX400/630	127.5	142.5	200	237	227.5	355	242.5	300	337	95.5	110	162	100	200	300	213.5	327	45
Type	F2	F3	ØT	U	Type	A5	A6	A7	A8	A9	E5	E6	E7	E8				
NSX100/160/250	17.5	70	24	≤ 32	NSX100/160/250 with PowerTag NSX	120.5	201	134	185	219.5	102.5	165	110	180				
NSX400/630	22.5	90	32	≤ 35	NSX400/630 with PowerTag NSX	192.5	320	207.5	265	302.5	165	265	178.5	192				

ComPacT NSX Dimensions and Mounting

One-Piece Spreader for ComPacT NSX100 to 250 Fixed Version

Dimensions

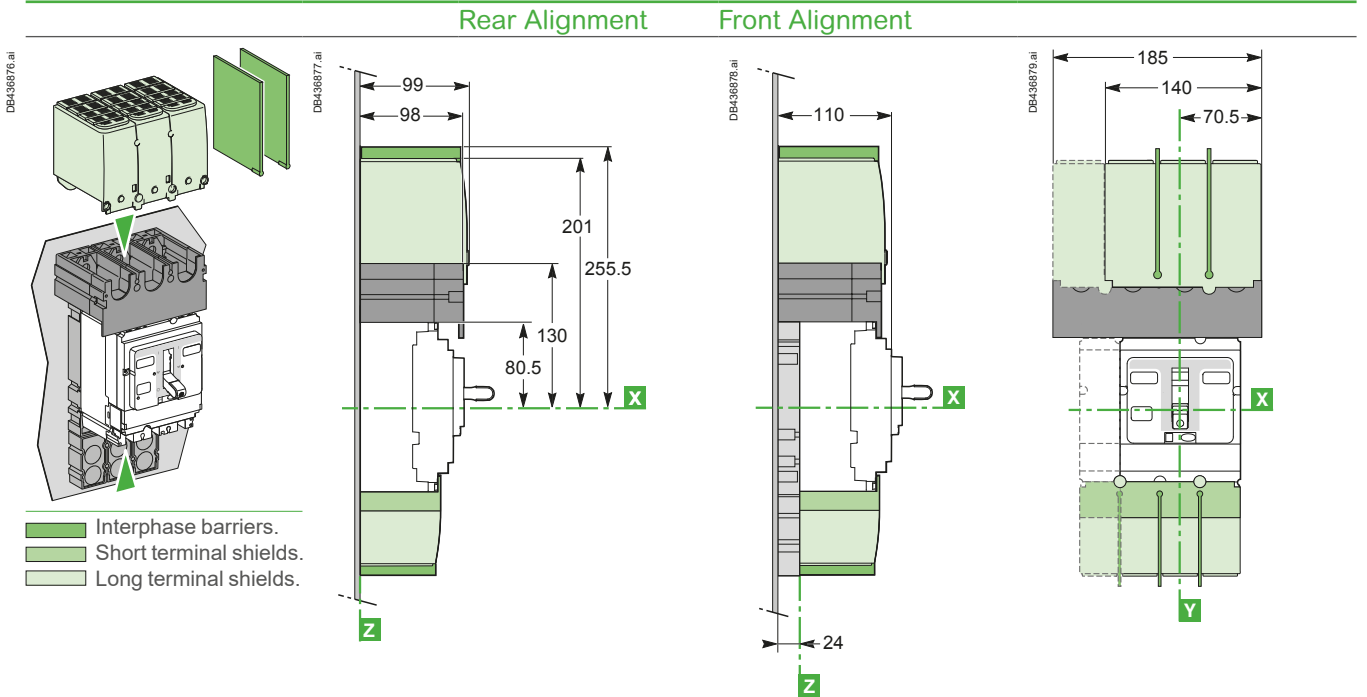

Mounting

Rear Alignment

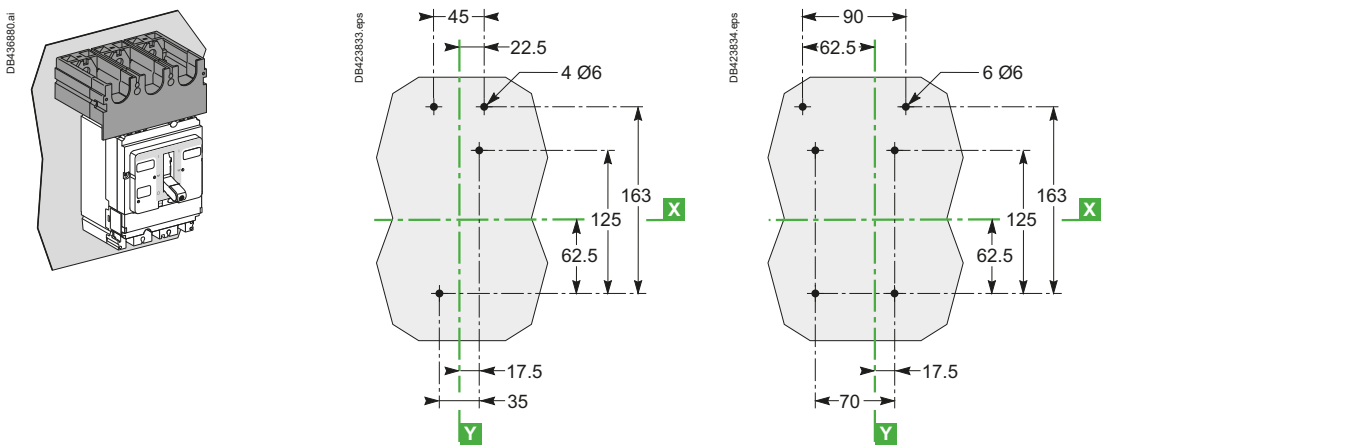

Front Alignment

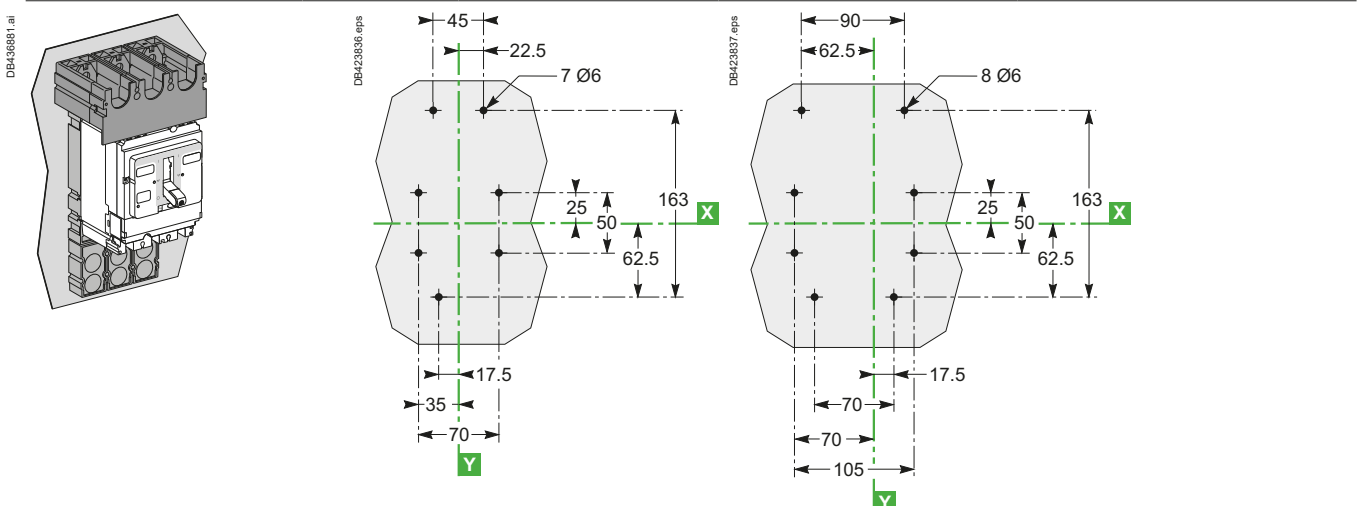

ComPacT NSX Dimensions and Mounting

External Modules

I/O (Input/Output) Application Module

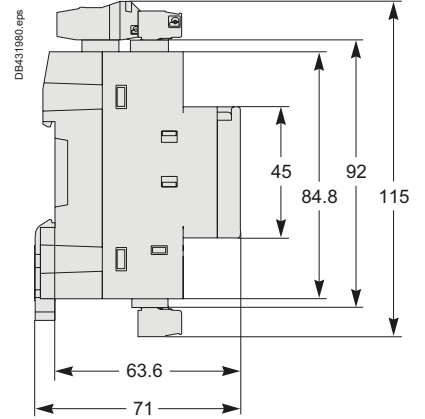
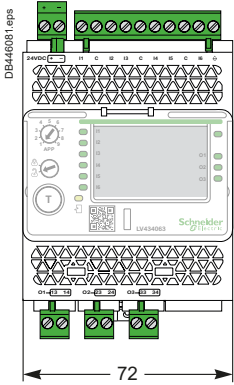

IFE - Ethernet Interface

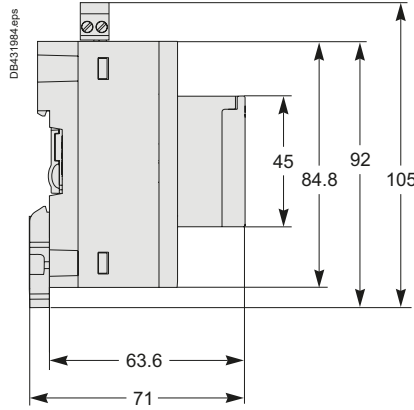
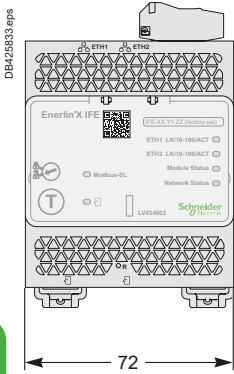

E

IFM - Modbus-SL Interface

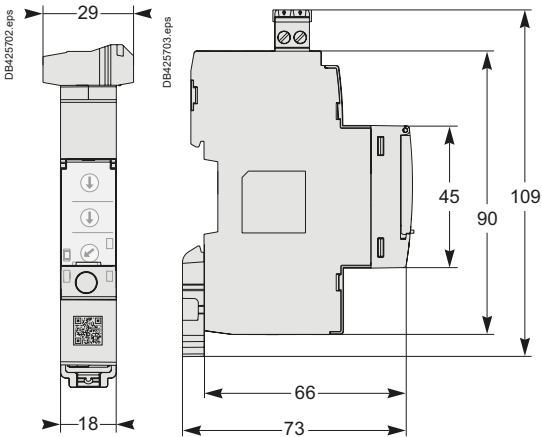

Modbus SL Hub

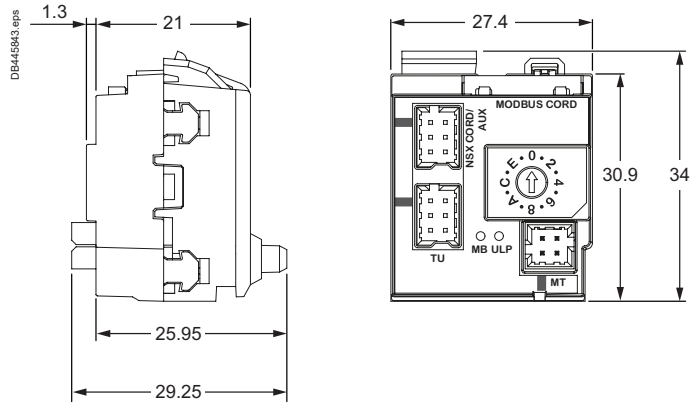

PAS600/PAS800

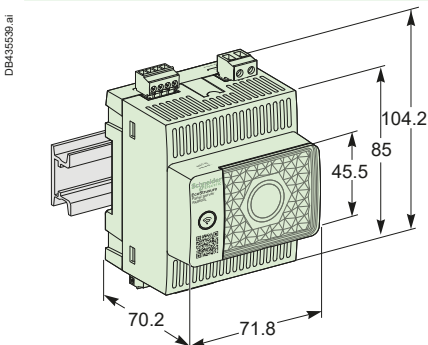

PAS400

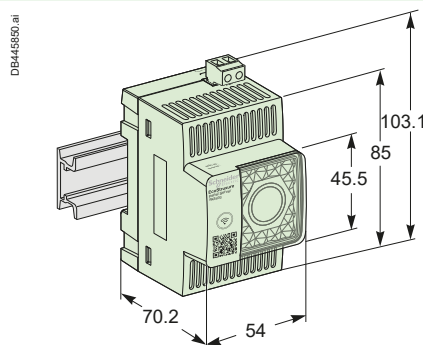

ComPacT NSX Dimensions and Mounting

FDM121 Switchboard Display

Dimensions

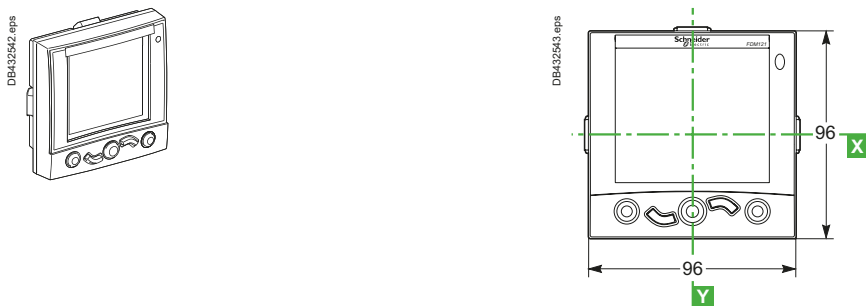

Mounting

Through Panel

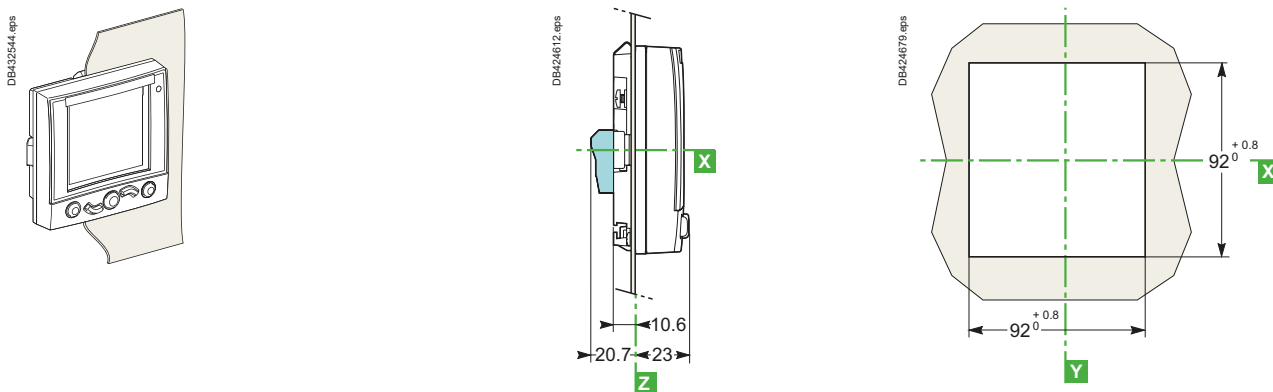

On Panel

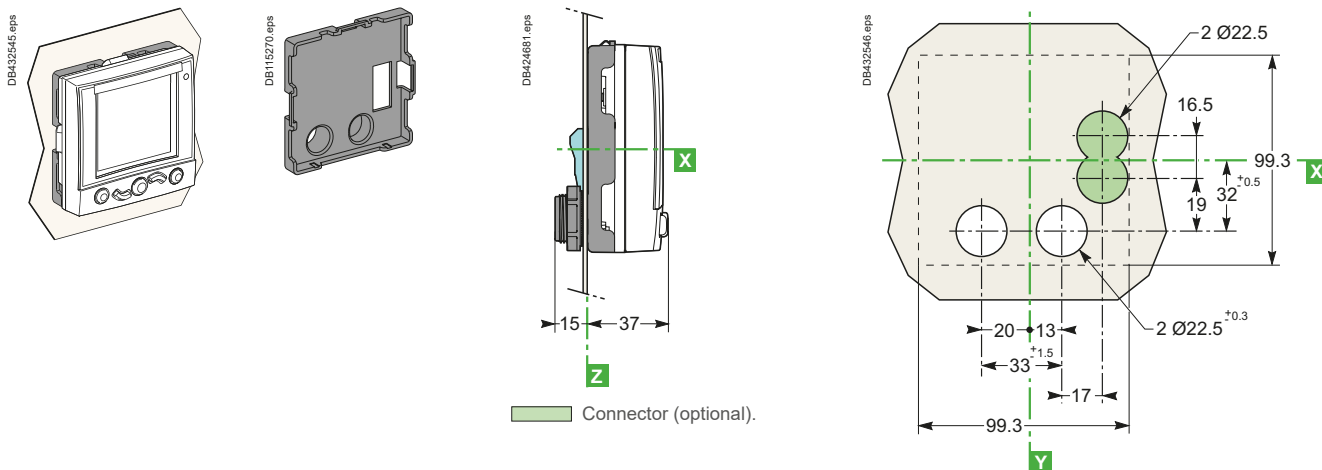

ComPacT NSX Dimensions and Mounting

FDM128 Switchboard Display

Dimensions

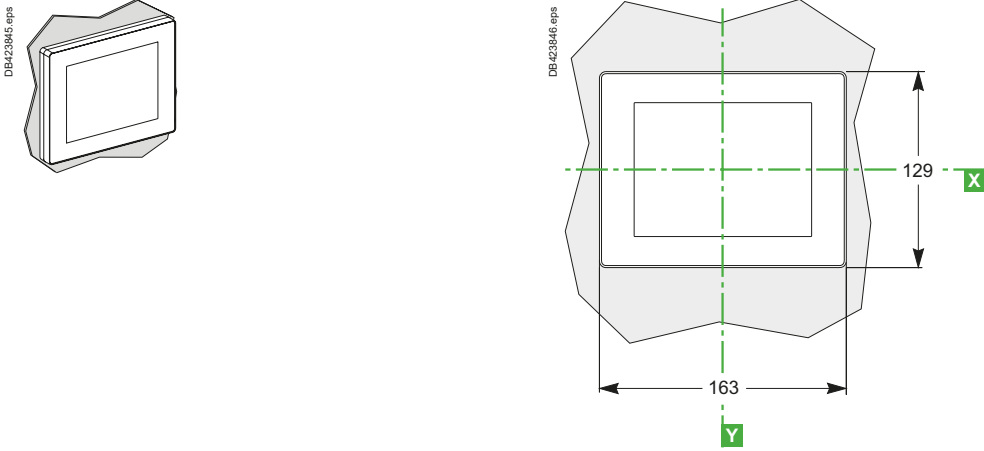

Mounting

On Panel

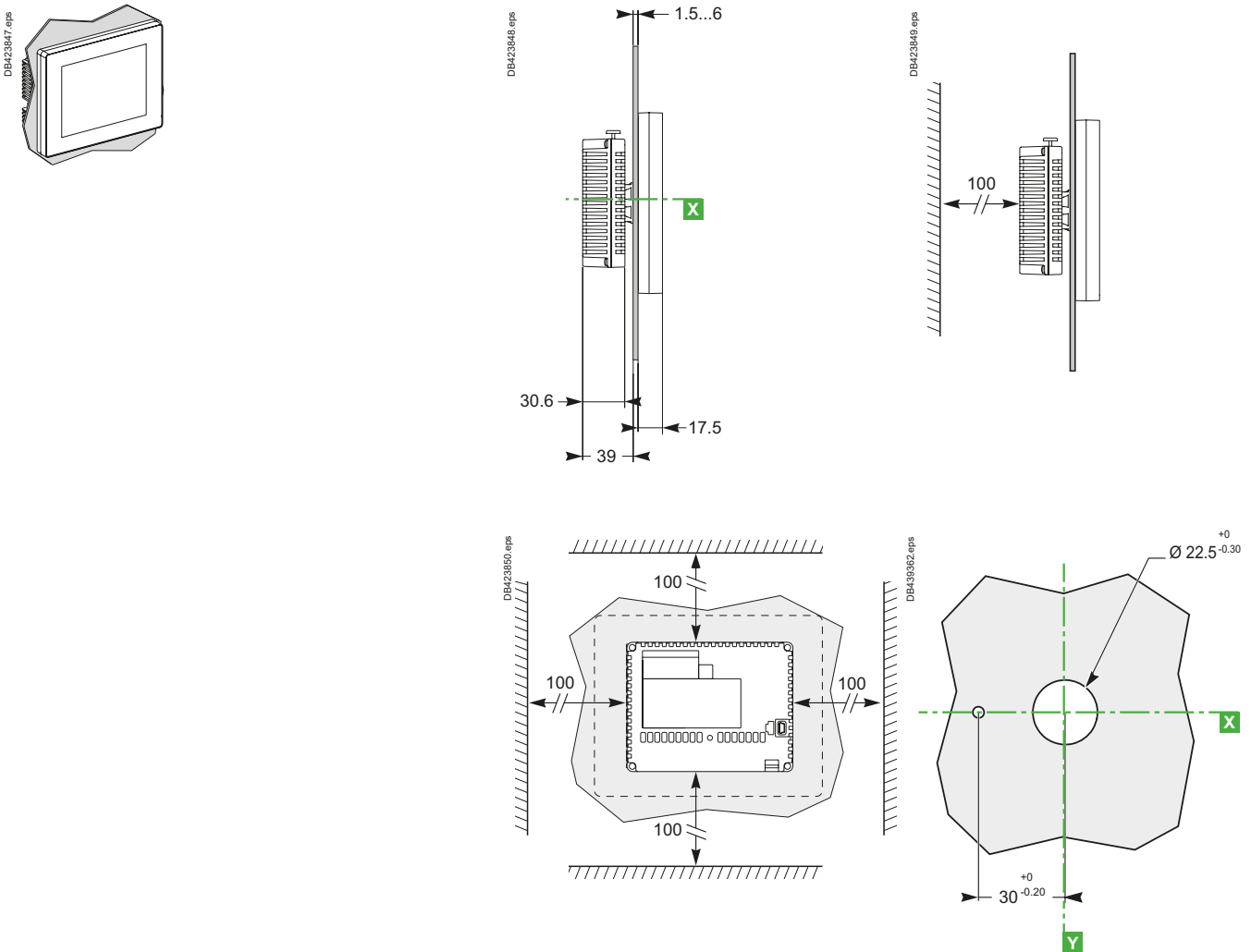

ComPacT NSX Front-Panel Accessories

ComPacT NSX100 to 630

IP30 Front-Panel Escutcheons

For Toggle, Rotary Handle or Motor Mechanism Module

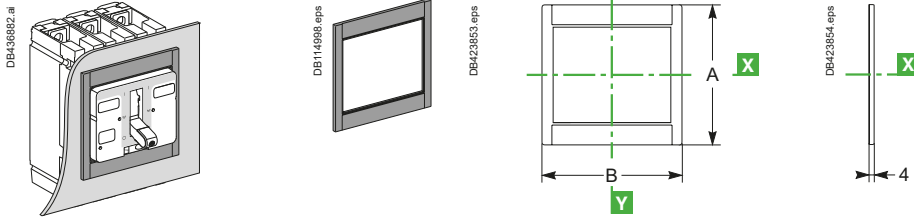

For Toggle or Rotary Handle with Access to Trip Unit

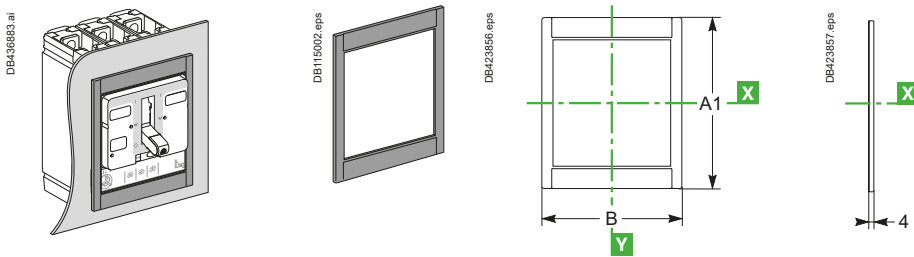

For VigiPacT Add-on

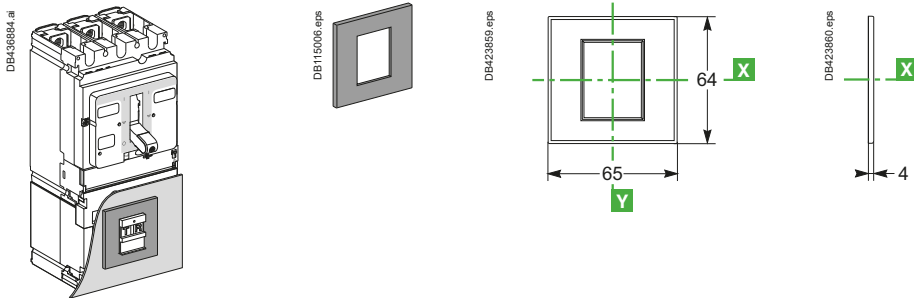

IP40 Front-Panel Escutcheons

For Toggle, Rotary Handle or Motor Mechanism Module and Protection Collar

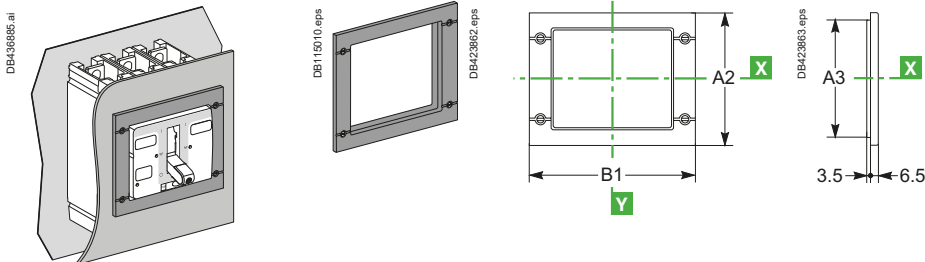

For VigiPacT Add-on with Protection Collar

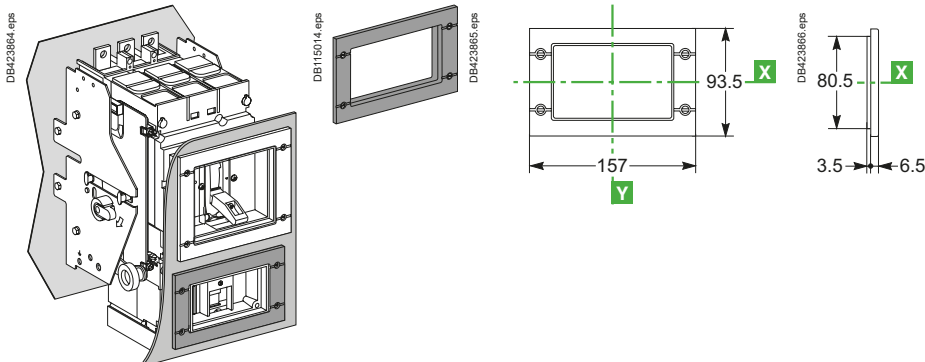

ComPacT NSX Front-Panel Accessories

ComPacT NSX100 to 630

IP40 Front-Panel Escutcheons (Cont.)

For VigiPacT Add-on

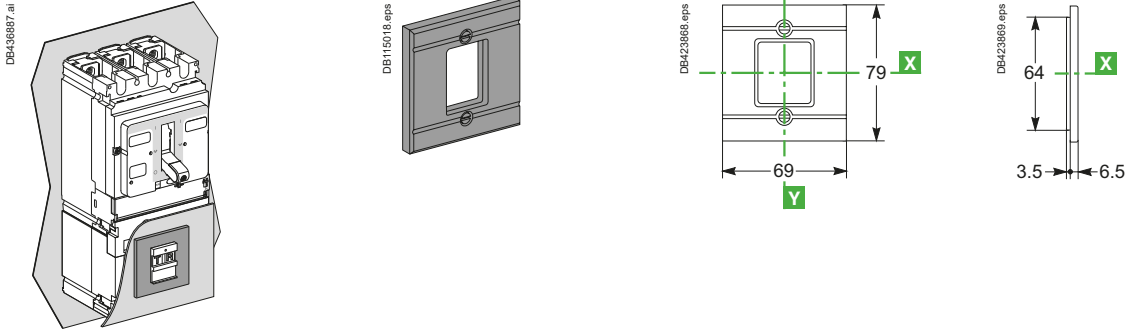

Protection Collars for IP40 Front-Panel Escutcheons

For Toggle

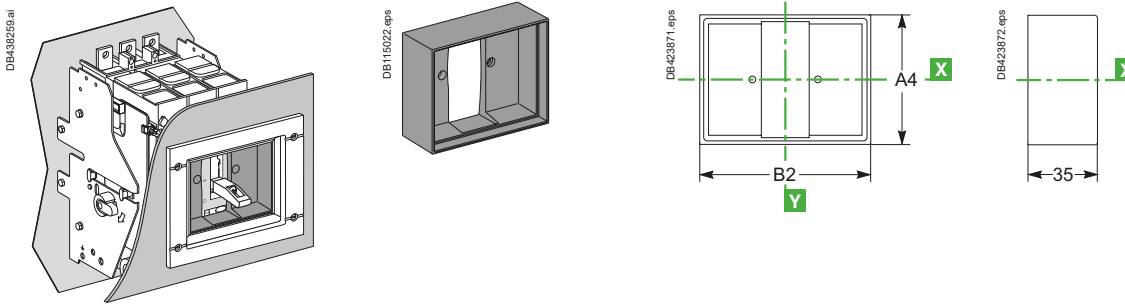

For VigiPacT Add-on

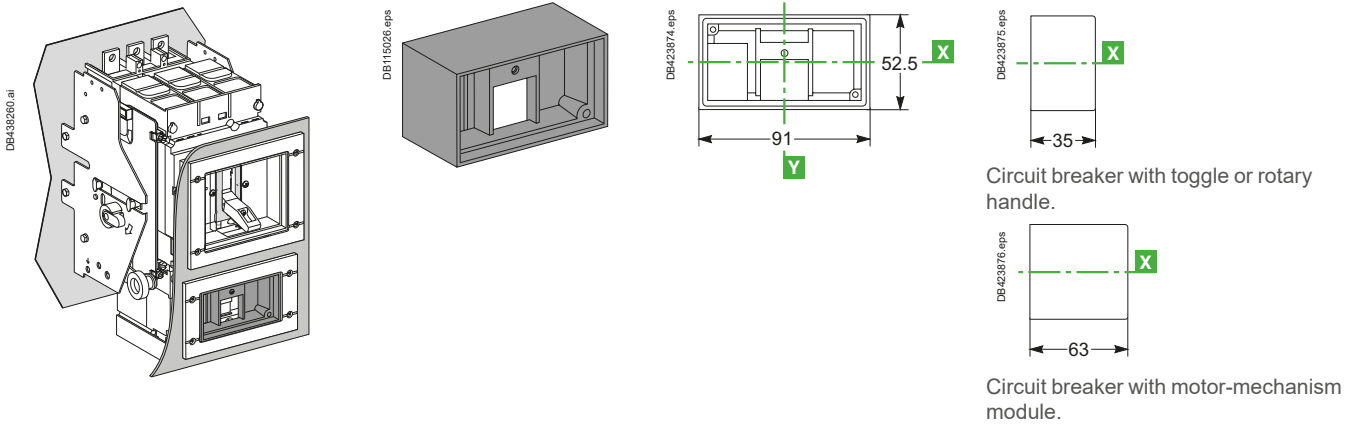

IP43 Toggle Cover

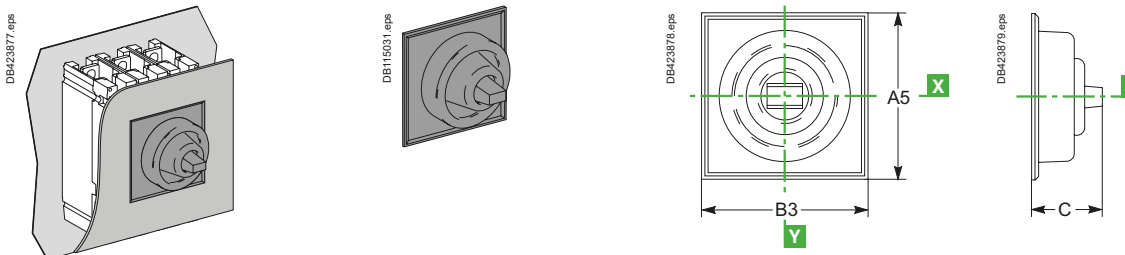

Type	A	A1	A2	A3	A4	A5	B	B1	B2	B3	C
NSX100/160/250	113	138	114	101	73	85	113	157	91	103	40
NSX400/630	163	211	164	151	122.5	138	163	189	122.5	138	60

ComPacT NSX Front-Panel Cutouts

ComPacT NSX100 to 630 Fixed Version

Bare Sheet Metal

NSX100 to 250

NSX400/630

For Toggle

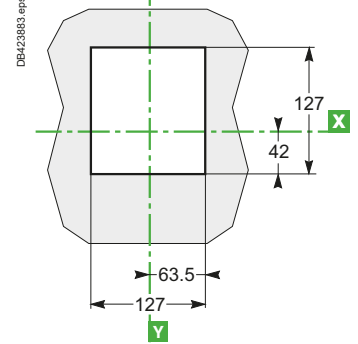
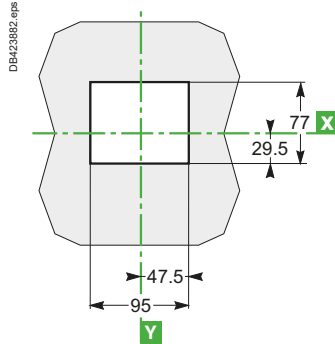
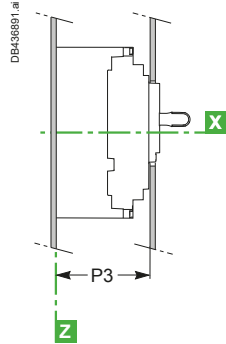
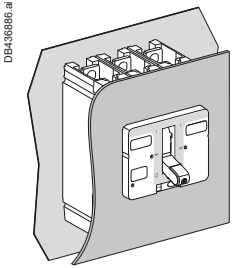

For Toggle with Access to Trip Unit

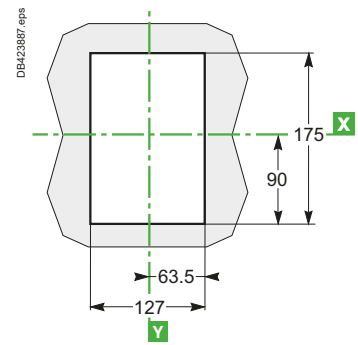
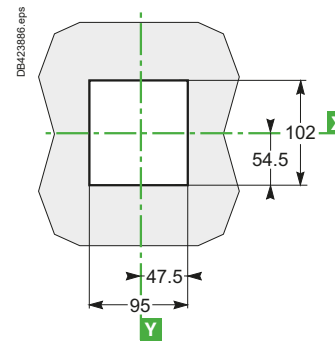
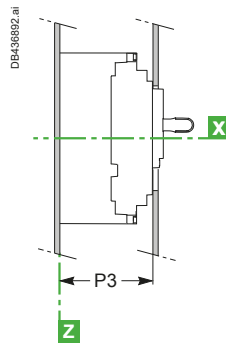
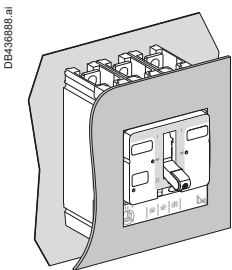

With IP30 Front-Panel Escutcheon

NSX100 to 250

NSX400/630

For Toggle

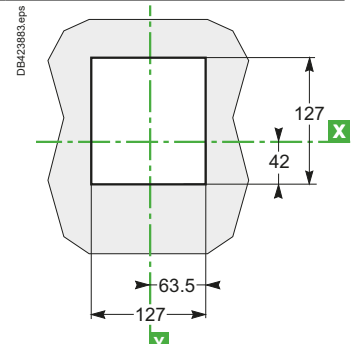
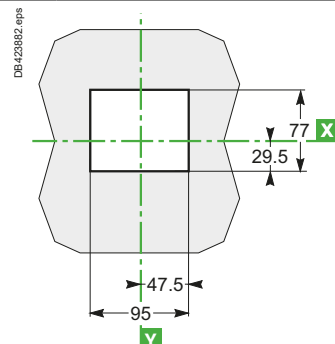
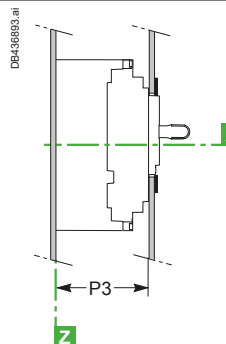
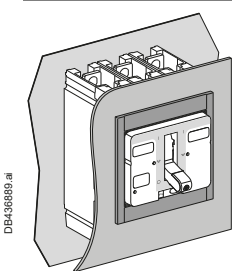

For Toggle with Access to Trip Unit

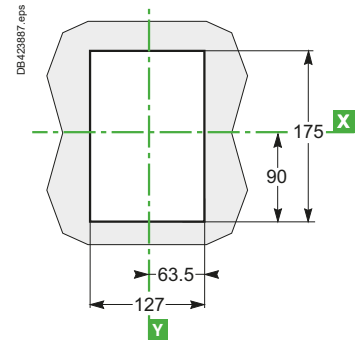
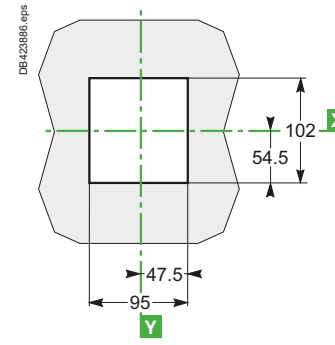
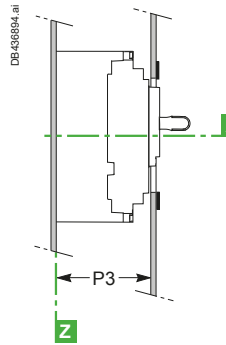
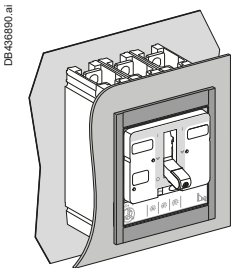

ComPacT NSX Front-Panel Cutouts

ComPacT NSX100 to 630 Fixed Version

With IP40 Front-Panel Escutcheon For Toggle

NSX100 to 250

NSX400/630

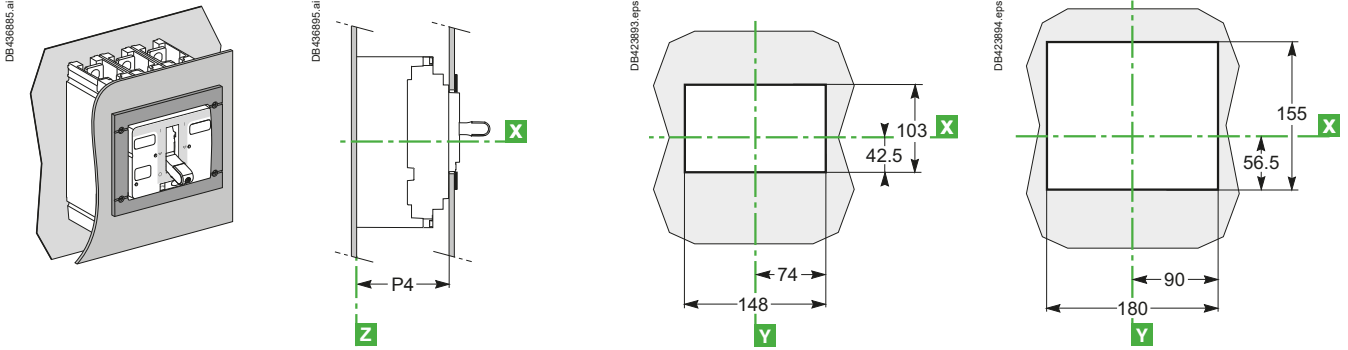

With IP43 Toggle Cover For Toggle

NSX100 to 250

NSX400/630

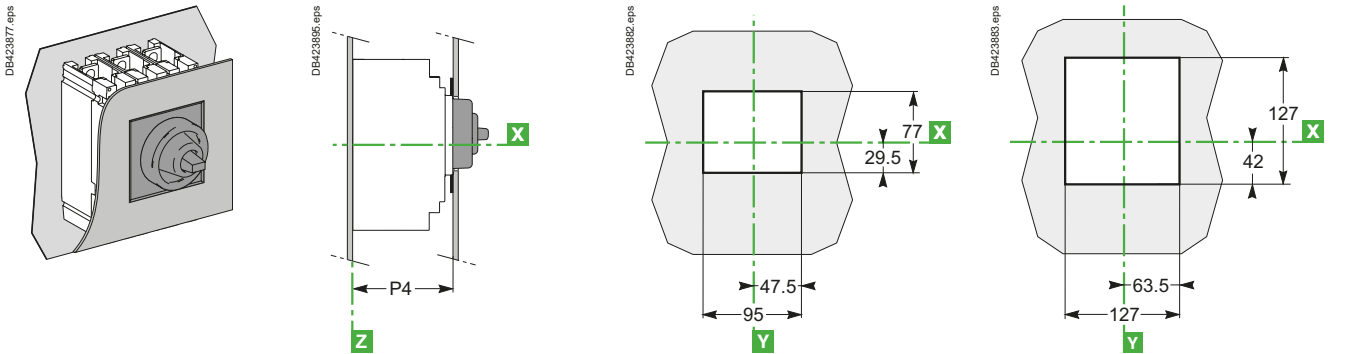

E

Type	P3	P4
NSX100/160/250	88	89
NSX400/630	112	113

Note: Door cutout dimensions are given for a device position in the enclosure where $D \geq 100 + (h \times 5)$ with respect to the door hinge.

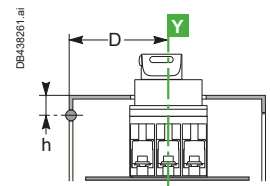

ComPacT NSX Front-Panel Cutouts

ComPacT NSX100 to 630 VigiPacT Add-on Fixed Version

Bare Sheet Metal

NSX100 to 250

NSX400/630

For Toggle

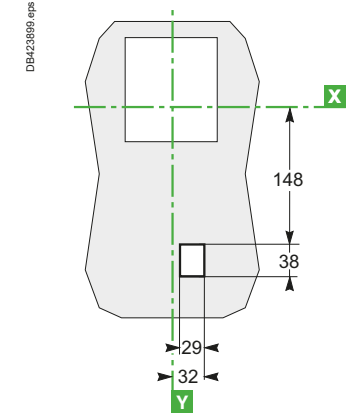
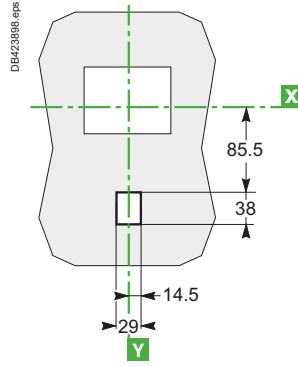
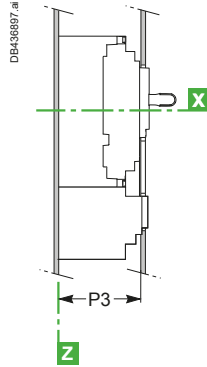
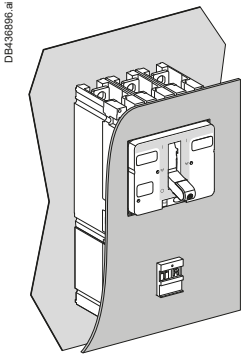

For Toggle with Access to Trip Unit

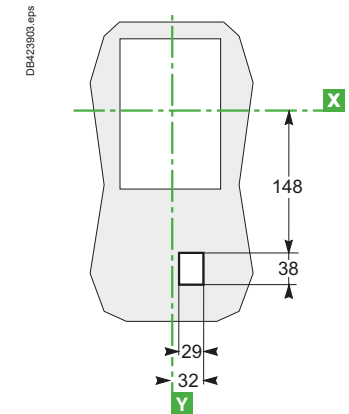
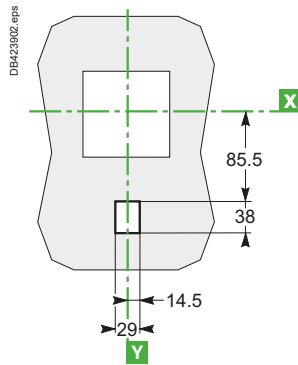
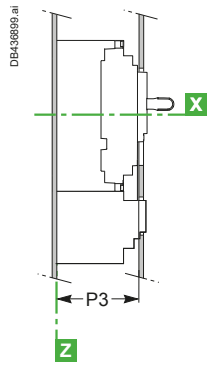
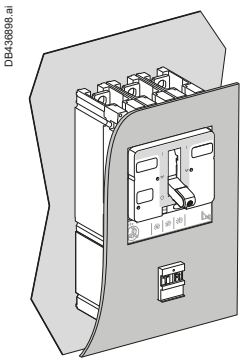

With IP30 Front-Panel Escutcheon

NSX100 to 250

NSX400/630

For Toggle

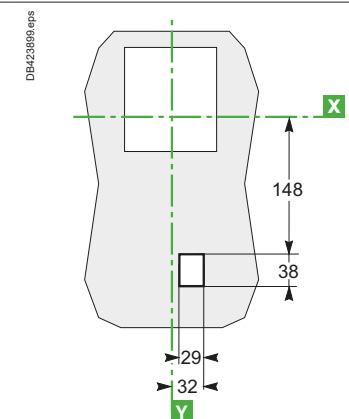
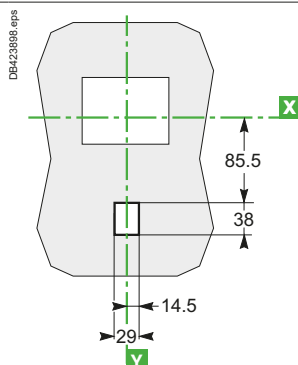
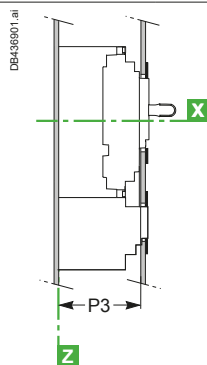
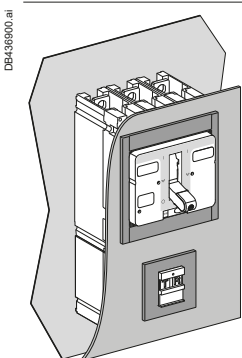

ComPacT NSX Front-Panel Cutouts

ComPacT NSX100 to 630 VigiPacT Add-on Fixed Version

With IP30 Front-Panel Escutcheon

For Toggle with Access to Trip Unit

NSX100 to 250

NSX400/630

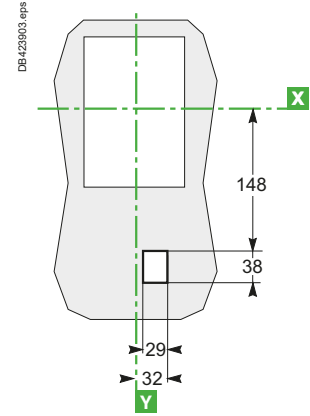
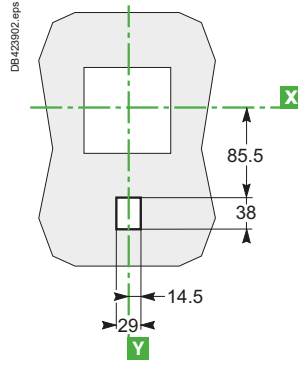
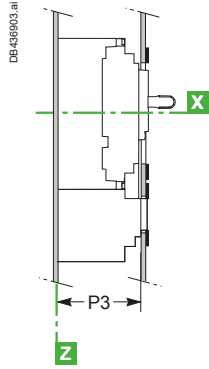
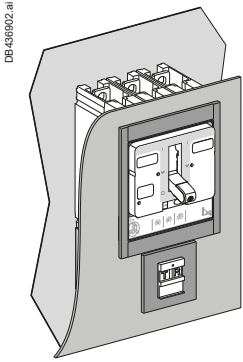

With IP40 Front-Panel Escutcheon

For Toggle

NSX100 to 250

NSX400/630

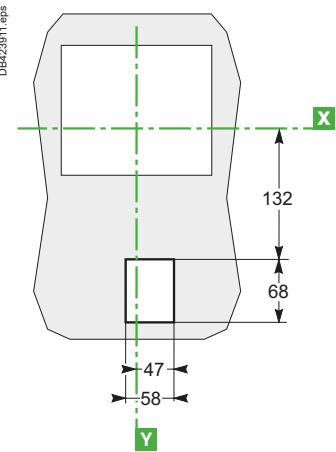
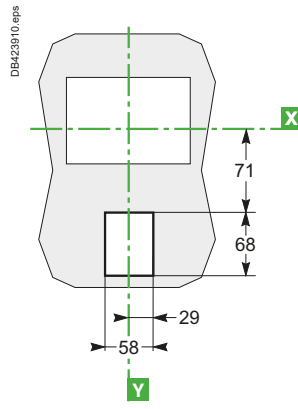
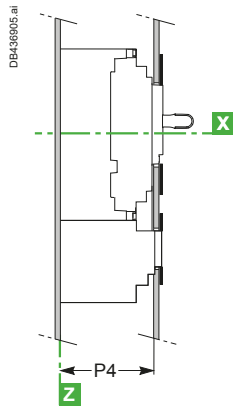
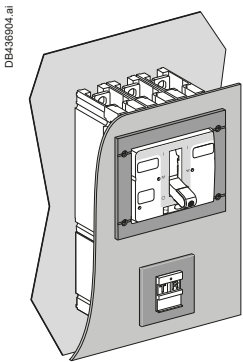

E

Type	P3	P4
NSX100/160/250	88	89
NSX400/630	112	113

Note: Door cutout dimensions are given for a device position in the enclosure where $\Delta \geq 100 + (h \times 5)$ with respect to the door hinge.

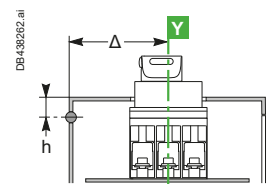

ComPacT NSX Front-Panel Cutouts

ComPacT NSX100 to 630 Plug-in and Withdrawable Versions

Plug-in Version

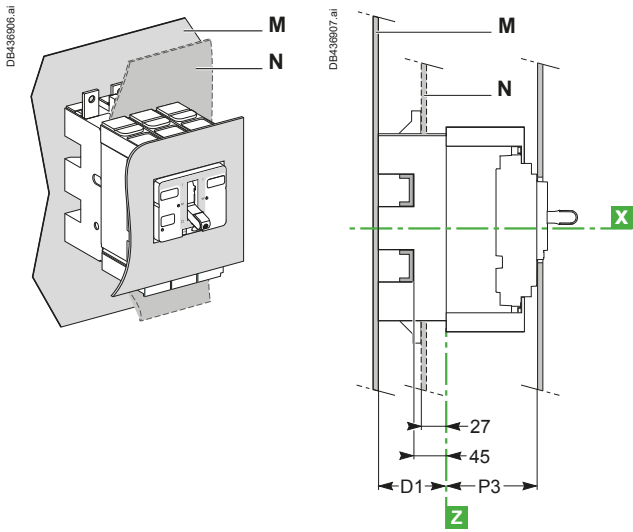

Bare sheet metal

See ComPacT NSX100 to 630 fixed version, [page E-55](#)

With IP30 front-panel escutcheon

See ComPacT NSX100 to 630 fixed version, [page E-55](#)

With IP40 front-panel escutcheon

See ComPacT NSX100 to 630 fixed version, [page E-56](#)

With toggle cover

See ComPacT NSX100 to 630 fixed version, [page E-56](#)

Withdrawable Version

NSX100 to 250

NSX400/630

With Protection Collar and IP40 Front-Panel Escutcheon

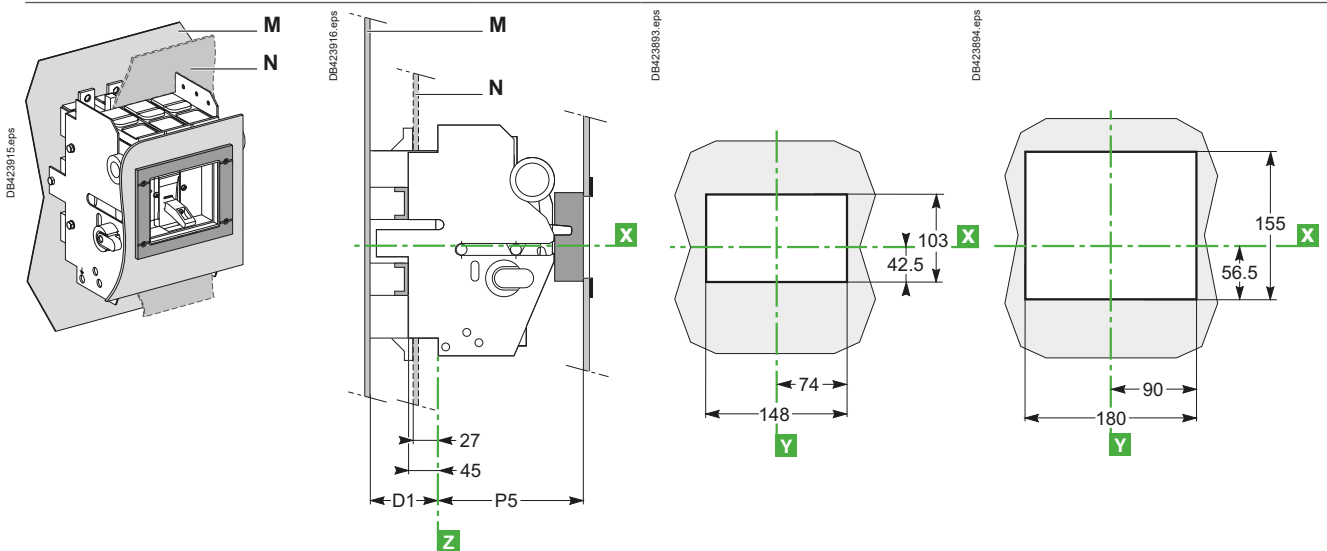

ComPacT NSX Front-Panel Cutouts

ComPacT NSX100 to 630 VigiPacT Add-on Plug-in and Withdrawable Versions

Plug-in Version

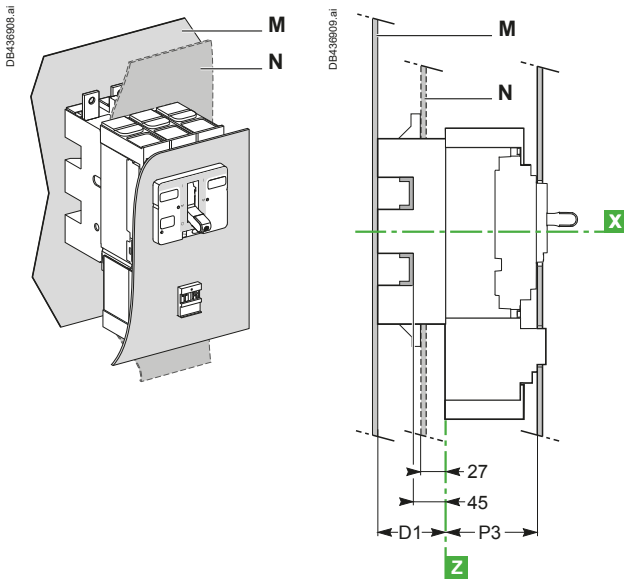

Bare sheet metal

See ComPacT NSX100 to 630 fixed version, [page E-57](#)

With IP30 front-panel escutcheon

See ComPacT NSX100 to 630 fixed version, [page E-57](#)

With IP40 front-panel escutcheon

See ComPacT NSX100 to 630 fixed version, [page E-58](#)

E

Withdrawable Version

NSX100 to 250

NSX400/630

With Protection Collar and IP40 Front-Panel Escutcheon

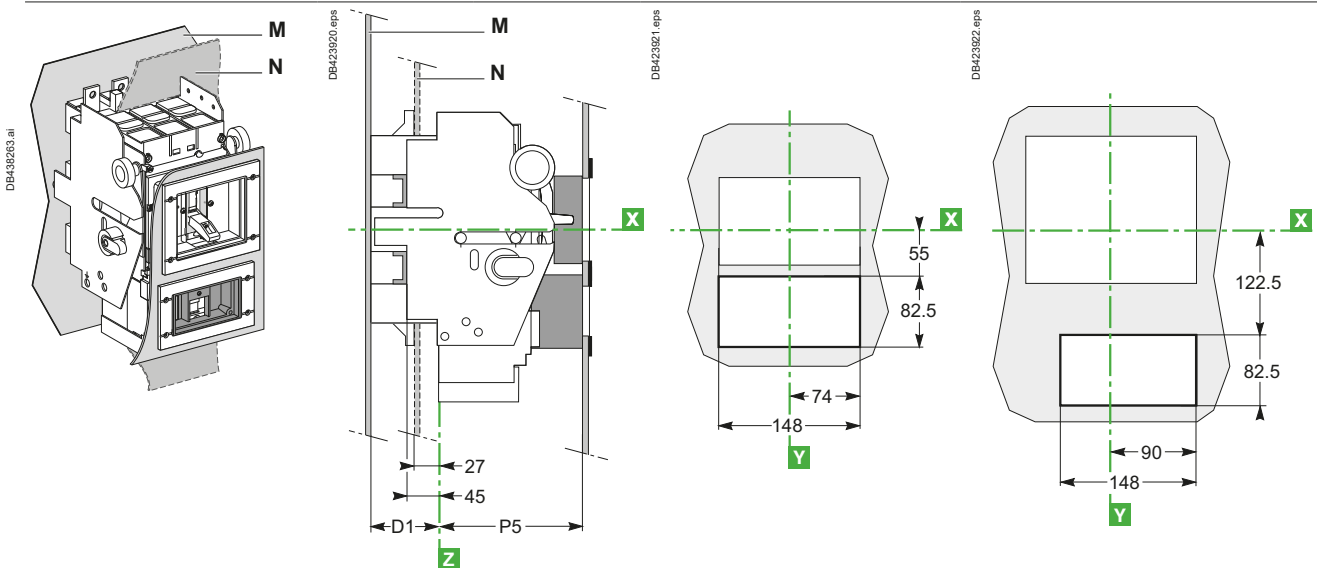

Type	D1	P3	P5
NSX100/160/250	75	88	123
NSX400/630	100	112	147

Note: Door cutout dimensions are given for a device position in the enclosure where $\Delta \geq 100 + (h \times 5)$ with respect to the door hinge.

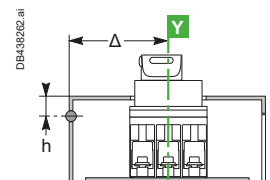

ComPacT NSX Front-Panel Cutouts

Visu Function for ComPacT NSX100 to 630 Fixed Version

ComPacT NSX100 to 250 with ComPacT INV100 to 250 Visu Function

Bare Sheet Metal

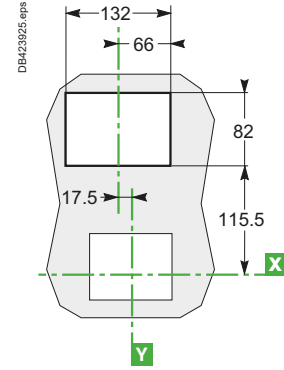
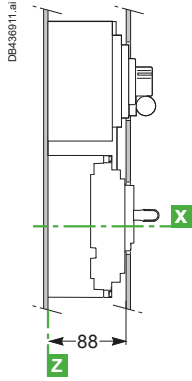
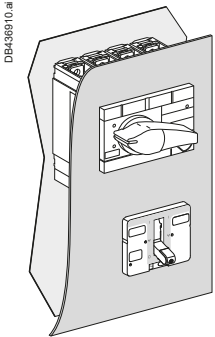

With IP40 Front-Panel Escutcheon

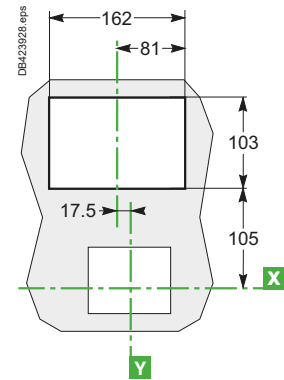
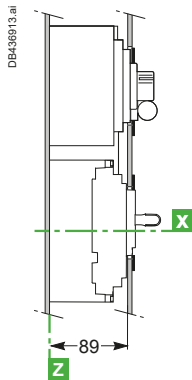
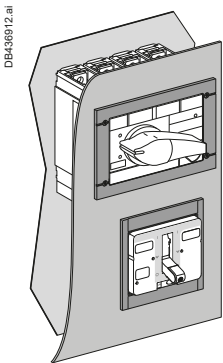

ComPacT NSX400/630 with ComPacT INV400 to 630 Visu Function

Bare Sheet Metal

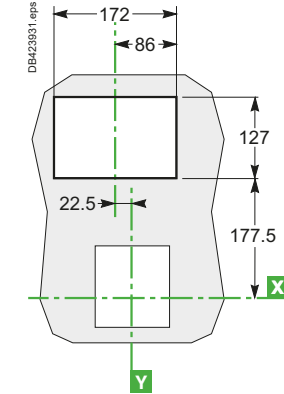
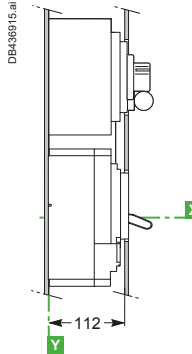
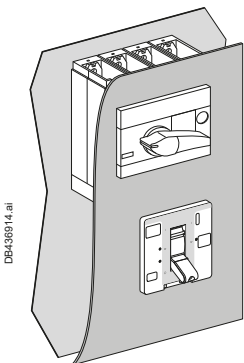

With IP40 Front-Panel Escutcheon

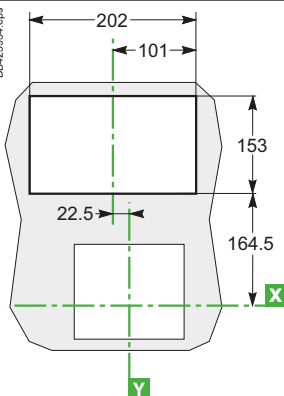
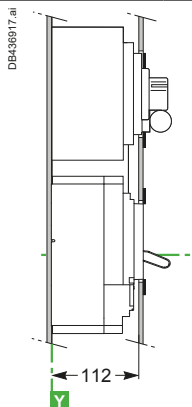
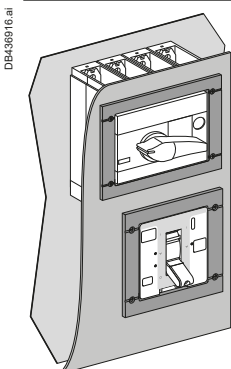

ComPacT NSX Front-Panel Cutouts

Motor Mechanism Module for ComPacT NSX100 to 630 with/without VigiPacT Add-on

Bare Sheet Metal

NSX100 to 250

NSX400/630

Fixed, Plug-in or Withdrawable Circuit Breaker

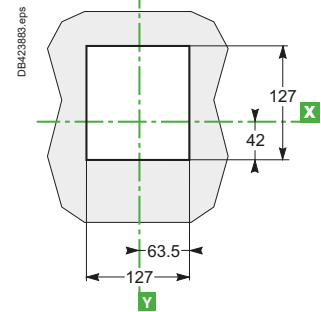
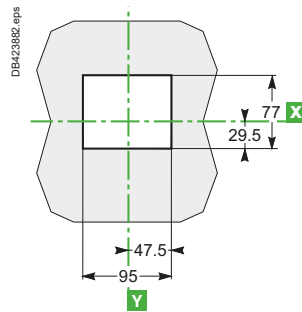
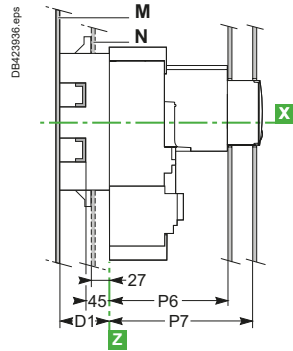
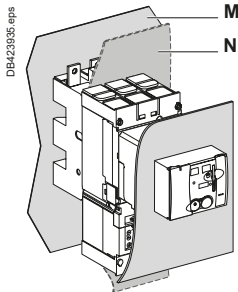

With IP30 Front-Panel Escutcheon

NSX100 to 250

NSX400/630

Fixed, Plug-in or Withdrawable Circuit Breaker

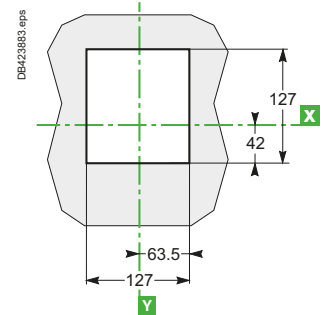
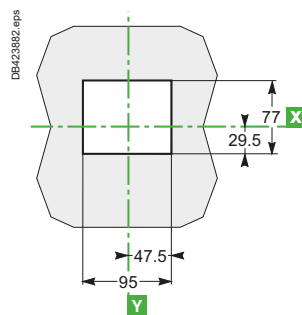
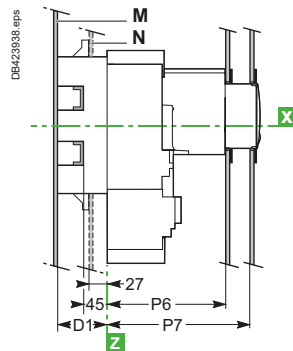
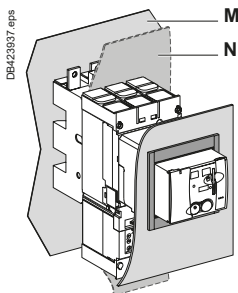

With IP40 Front-Panel Escutcheon

NSX100 to 250

NSX400/630

Fixed, Plug-in or Withdrawable Circuit Breaker without Access to VigiPacT Add-on

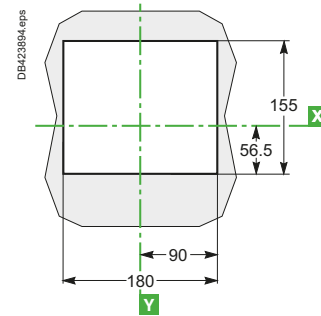
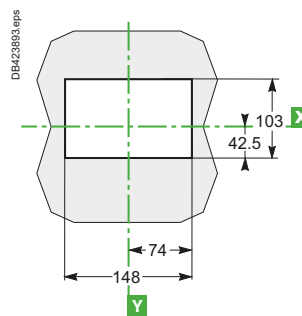
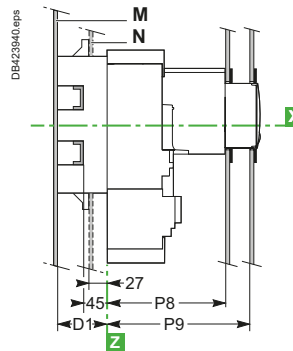
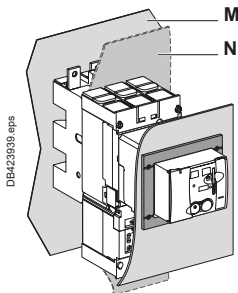

Fixed or Plug-in Circuit Breaker with Access to VigiPacT Add-on

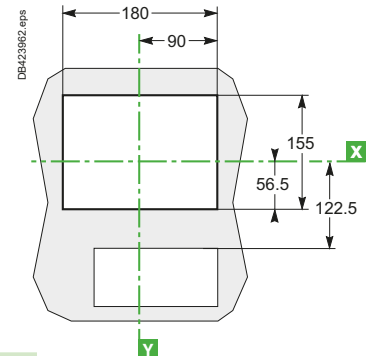
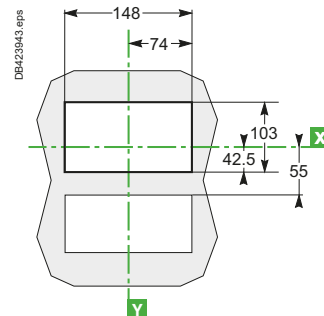
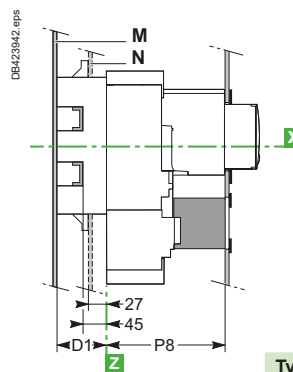
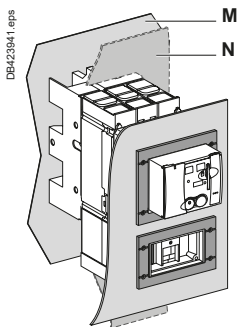

Type	D1	P6 [1]	P7 [2]	P8 [1]	P9 [2]
NSX100/160/250	75	145	177	146	178
NSX400/630	100	217	249	218	250

[1] Plug-in version.

[2] Withdrawable version.

ComPacT NSX Front-Panel Cutouts

Direct Rotary Handle for ComPacT NSX100 to 630 with/without VigiPacT Add-on

Fixed or Plug-in Circuit Breakers Bare Sheet Metal

NSX100 to 250

NSX400/630

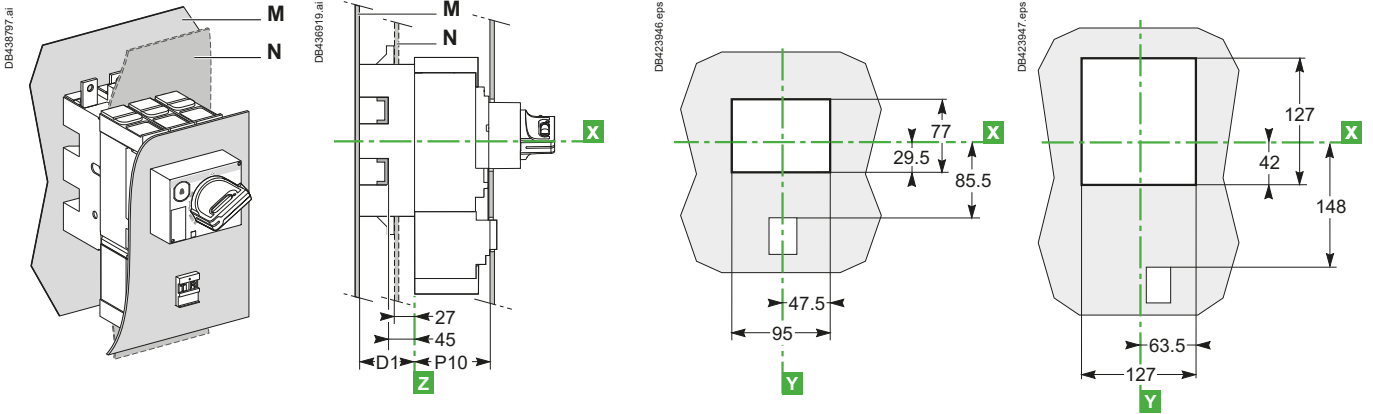

Bare Sheet Metal with Access to the Trip Unit

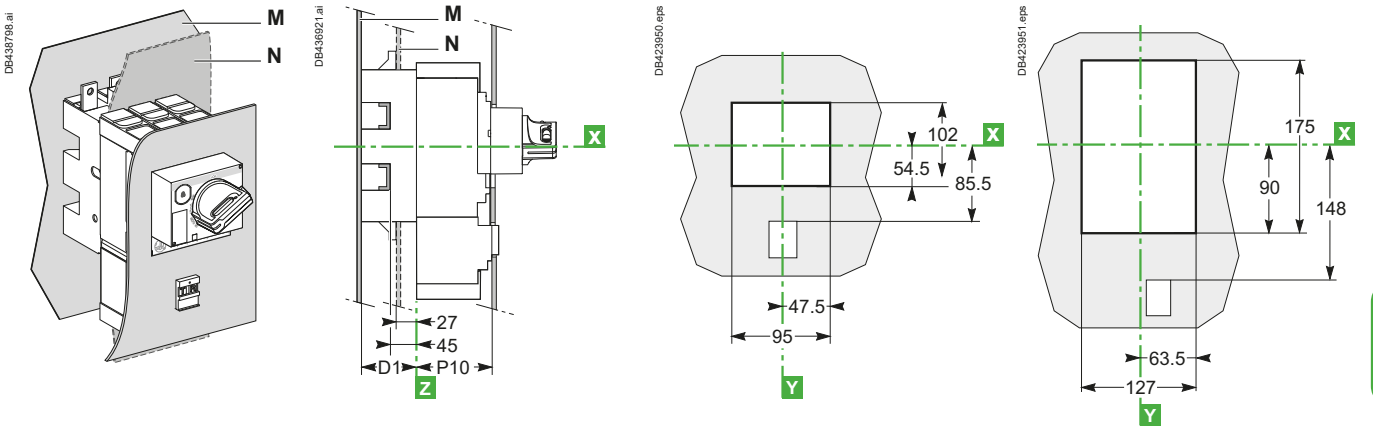

With IP30 Front-Panel Escutcheon

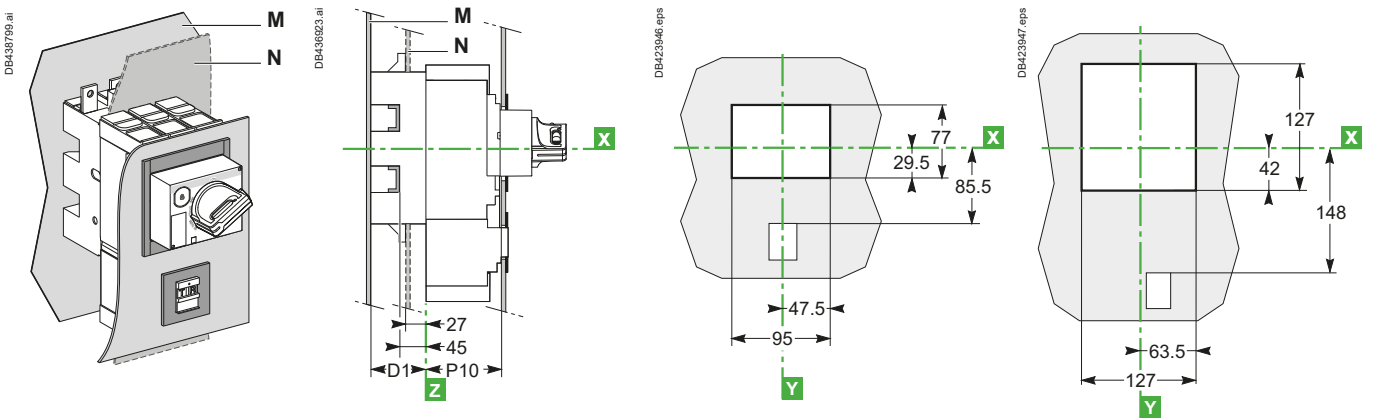

ComPacT NSX Front-Panel Cutouts

Direct Rotary Handle for ComPacT NSX100 to 630 with/without VigiPacT Add-on

Fixed or Plug-in Circuit Breakers

NSX100 to 250

NSX400/630

With IP30 Front-Panel Escutcheon with Access to the Trip Unit

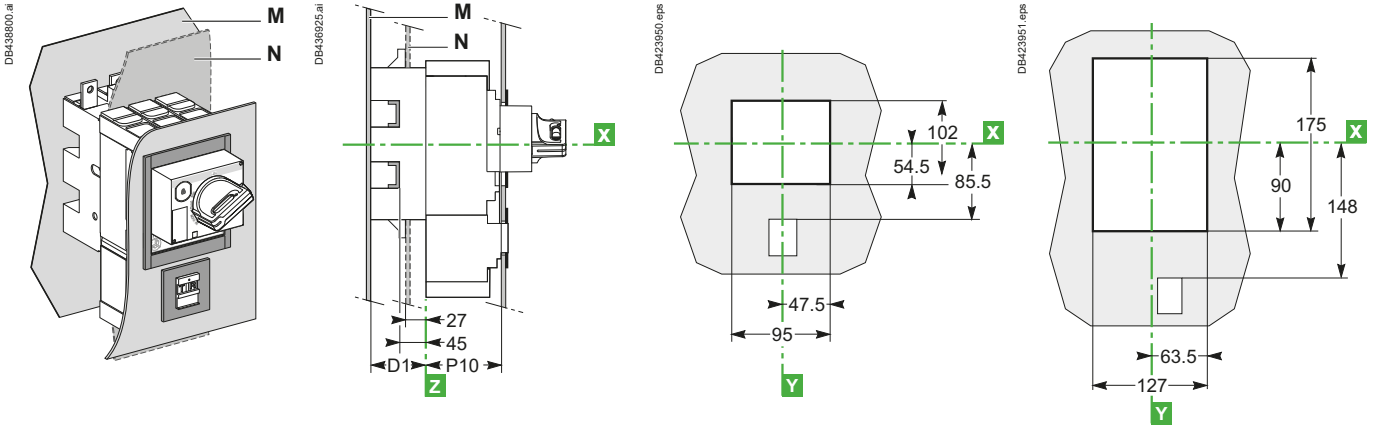

With IP40 Front-Panel Escutcheon

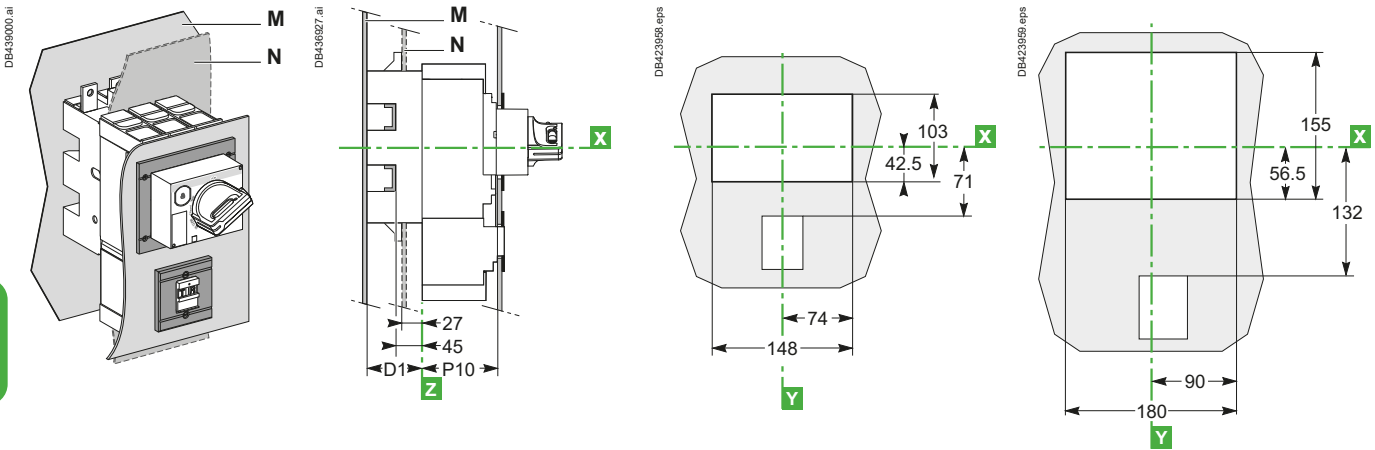

Fixed or Withdrawable Circuit Breakers

NSX100 to 250

NSX400/630

With IP40 Front-Panel Escutcheon

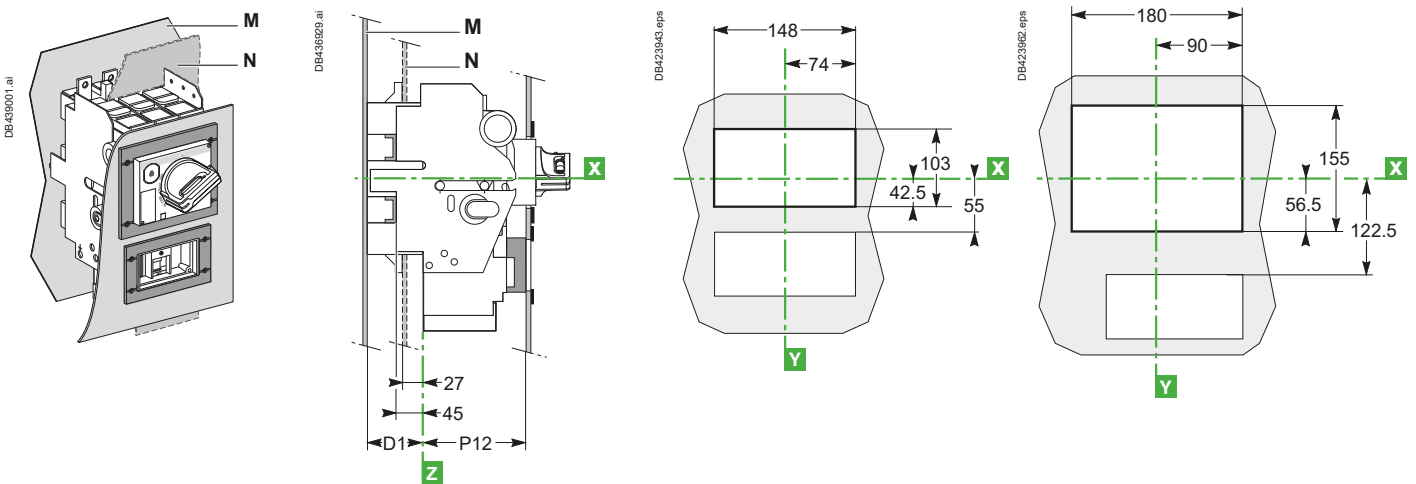

Type	D1	P10	P11	P12
NSX100/160/250	75	89	90	123
NSX400/630	100	112	113	147

ComPacT NSX Power Connections

ComPacT NSX100 to 630 with/without VigiPacT Add-on Fixed Version

Connection Locations

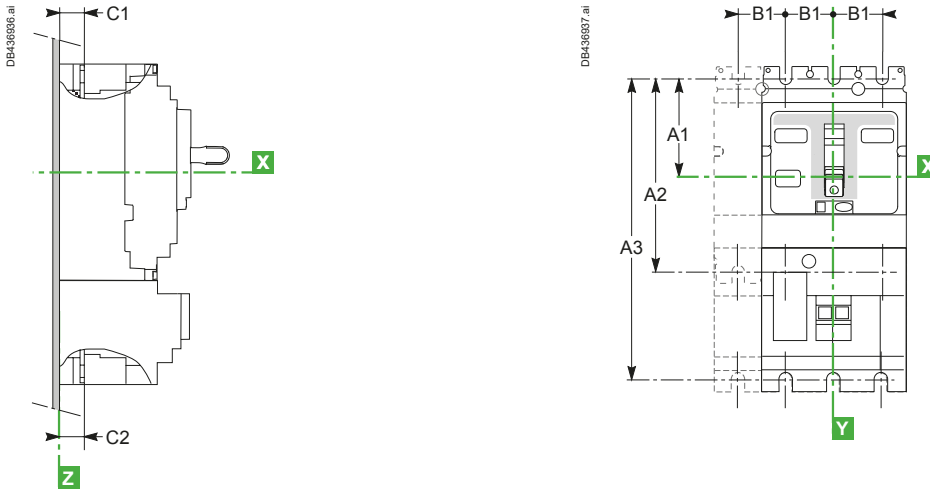

Type	A1	A2	B1	C1	C2
NSX100/160	70	140	35	19.5	19.5
NSX250	70	140	35	21.5	19.5
NSX400/630	113.5	227	45	26	26

Type	A1	A3	B1	C1	C2
NSX100/160 + Vigi	70	215	35	19.5	21.5
NSX250 + Vigi	70	215	35	21.5	21.5
NSX400/630 + Vigi	113.5	327	45	26	26

Front Connection without Accessories

NSX100 to 250

NSX400/630

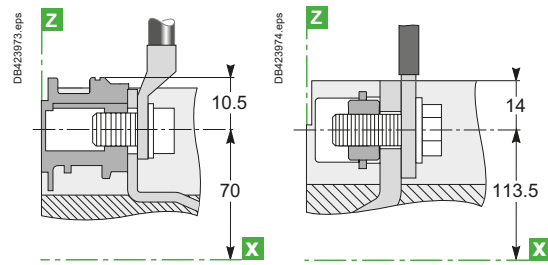
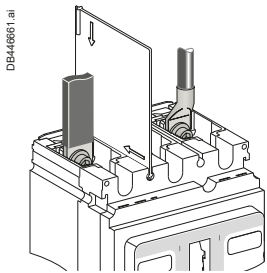

Cables with lugs/bars

Bars/cables with lugs

Connection with Accessories

Long and Short Rear Connectors

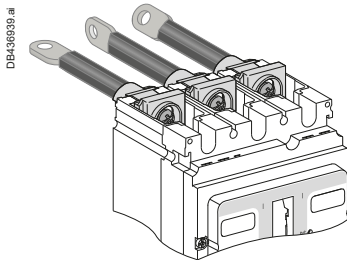

NSX100 to 250

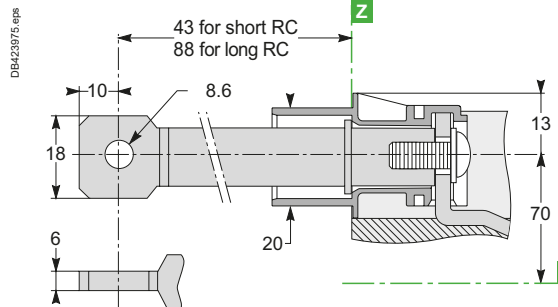

NSX400/630

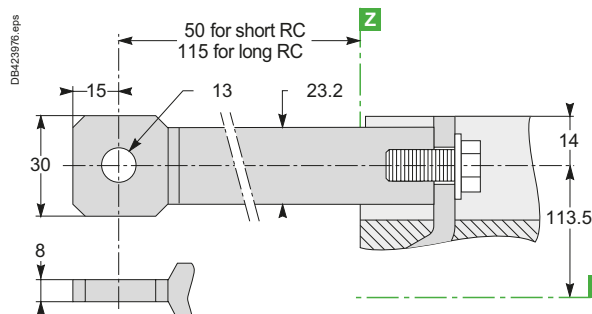

ComPacT NSX Power Connections

ComPacT NSX100 to 630 with/without VigiPacT Add-on Fixed Version

Connection with Accessories

Bare-Cable Connectors

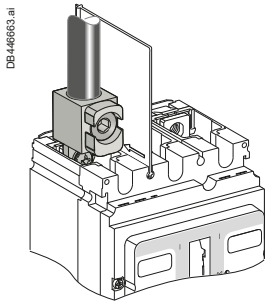
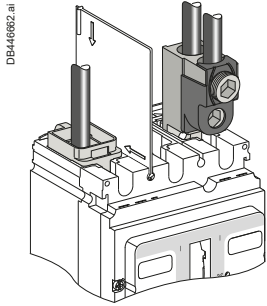

NSX100 to 250

DB423977.eps

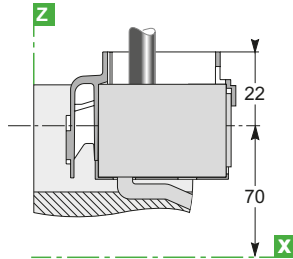

DB423978.eps

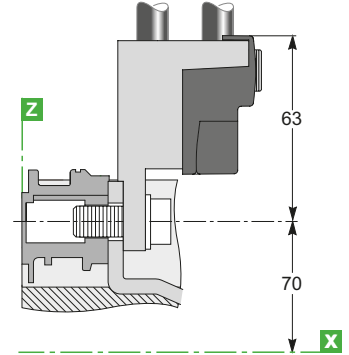

DB423935.eps

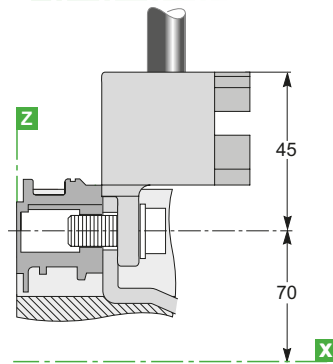

NSX400/630

DB423975.eps

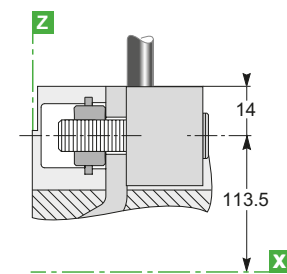

DB423980.eps

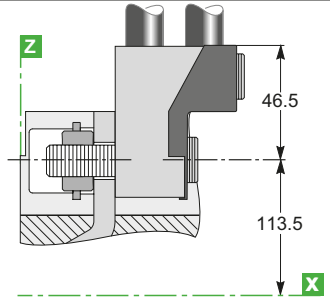

E

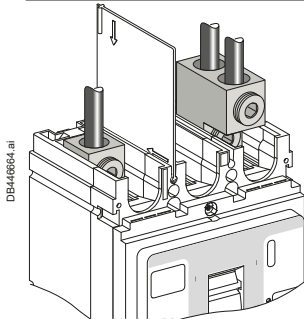

Distribution Connectors (for NSX100 to 250 Only)

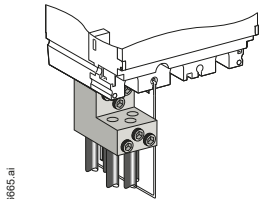

[a] VigiPacT add-on or NSX250

DB423801.eps

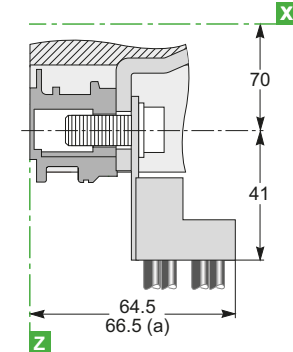

Right-Angle Terminal Extensions (Upstream Only) NSX100 to 250

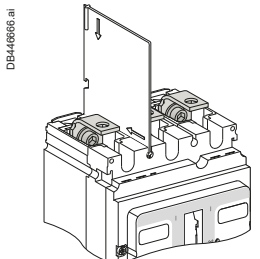

[b] NSX250

DB439634.eps

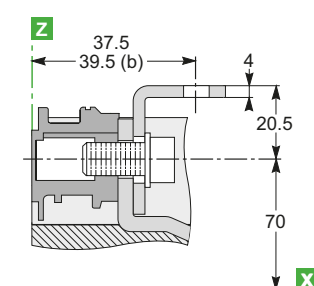

NSX400/630

DB423893.eps

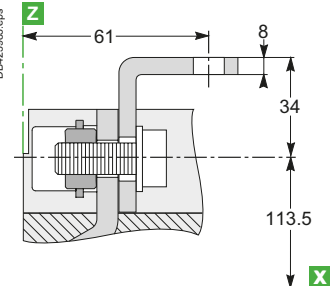

ComPacT NSX Power Connections

ComPacT NSX100 to 630 with/without VigiPacT Add-on Fixed Version

Connection with Accessories

Straight Terminal Extensions (for NSX100 to 250 Only)

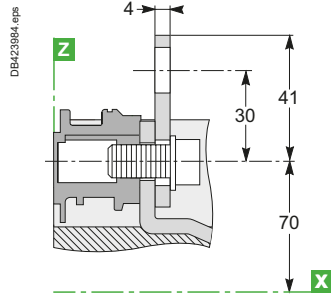
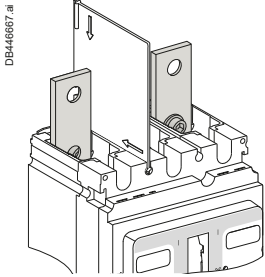

Edgewise Terminal Extensions

NSX100 to 250

NSX400/630

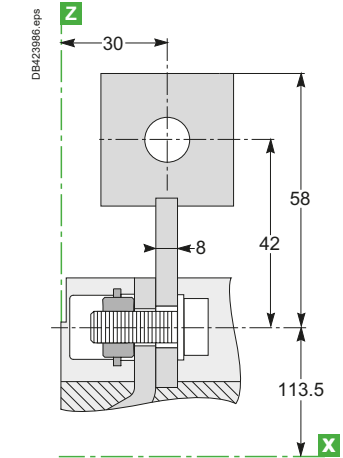
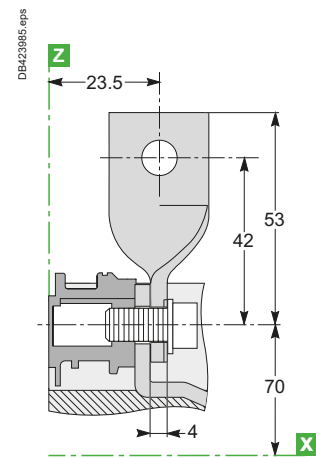
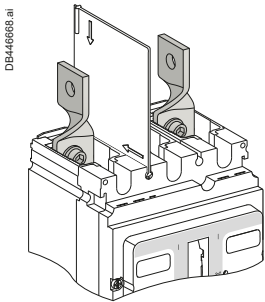

45° Terminal Extensions

NSX100 to 250

NSX400/630

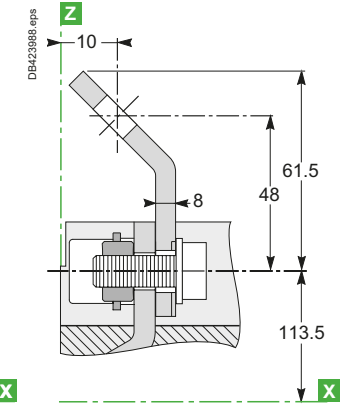
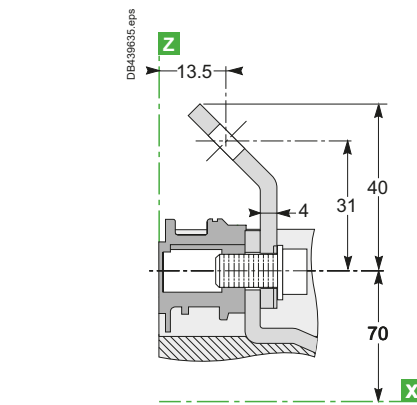
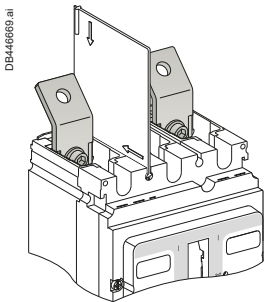

Double-L Terminal Extensions

NSX100 to 250

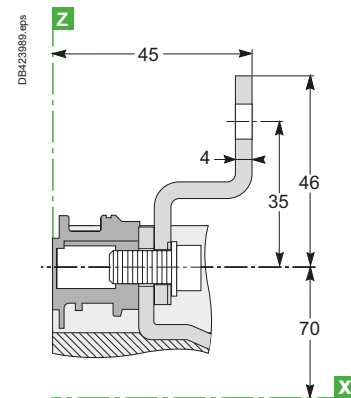
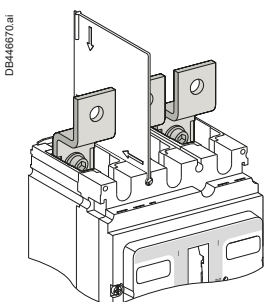

ComPacT NSX Power Connections

ComPacT NSX100 to 630 with/without VigiPacT Add-on Fixed Version

Connection with Accessories

Spreaders

3P

4P

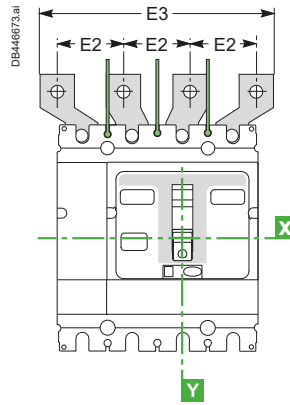
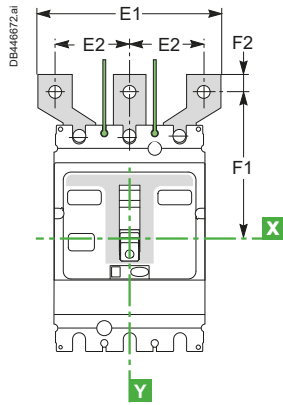
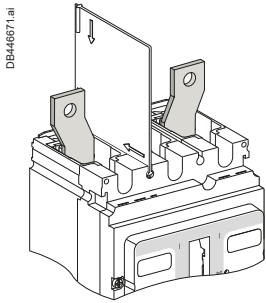

NSX100 to 250

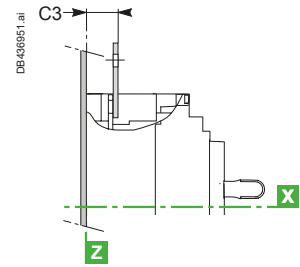

NSX400/630

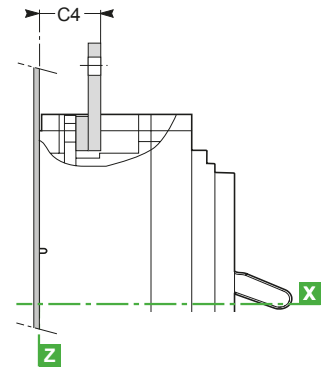

E

Type	C3	C4	E1	E2	E3	F1	F2
NSX100/160	23.5	-	114	45	159	100	11
NSX250	25.5	-	114	45	159	100	11
NSX400/630	-	44	135 170	52.5 70	187.5 240	152.5 166	15 15

One-Piece Spreader (for NSX100 to 250 Only)

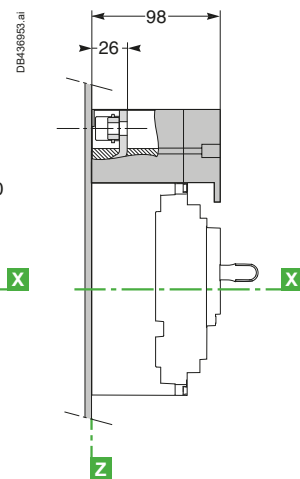
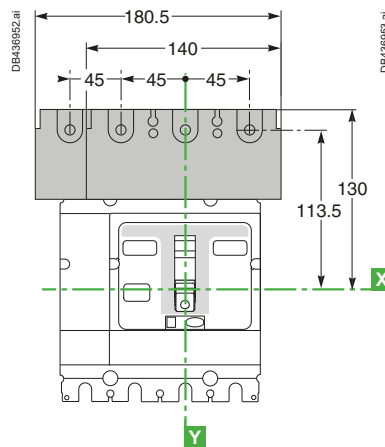
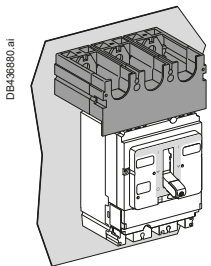

ComPacT NSX Power Connections

ComPacT NSX100 to 630 with/without VigiPacT Add-on Plug-in and Withdrawable Versions

Connection Locations

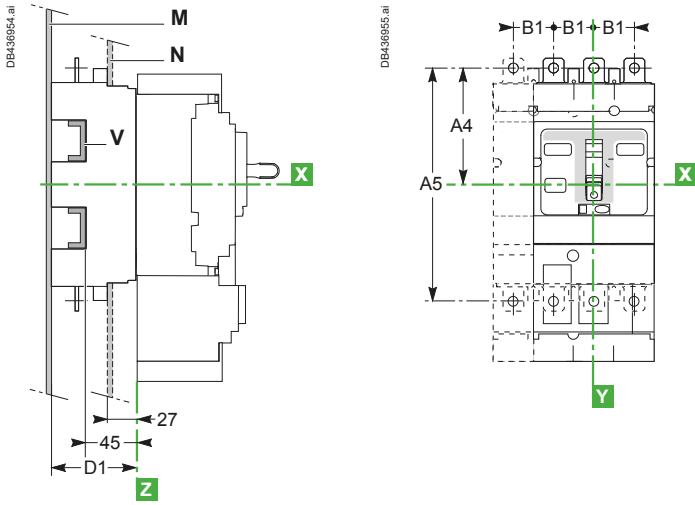

Type	A4	A5	B1	D1
NSX100 to 250	100	200	35	75
NSX400/630	156.5	313	45	100

Note:

- For mounting on a backplate, the insulating screen supplied with the plug-in base must be installed.
- For withdrawable versions, terminal shields are recommended.

Connection without Accessories

Front Connection: Mounting on Backplate (M) or Rails (V)

NSX100 to 250

NSX400/630

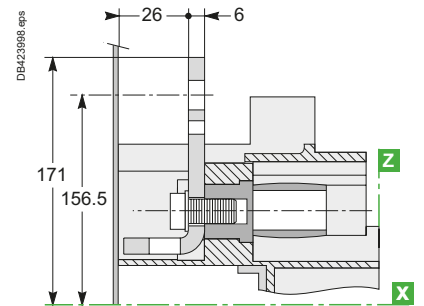
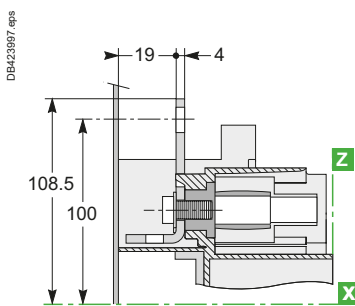
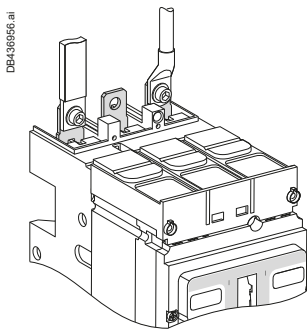

Rear Connection: Mounting Through Front Panel (N) or on Rails (V)

NSX100 to 250

NSX400/630

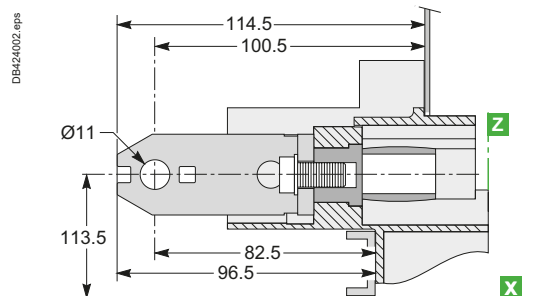
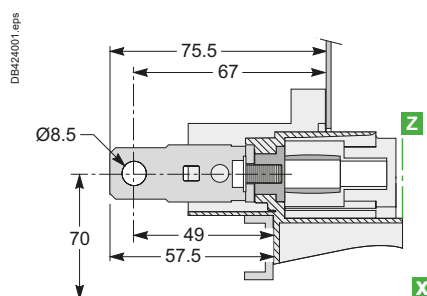
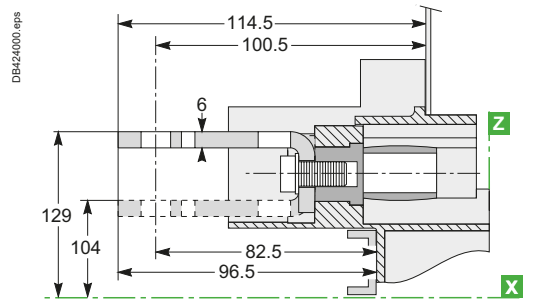
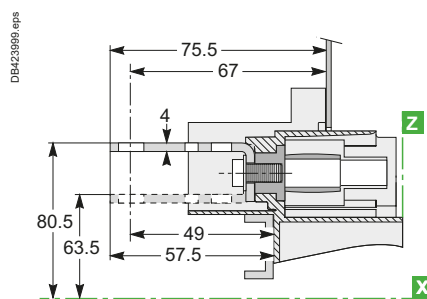
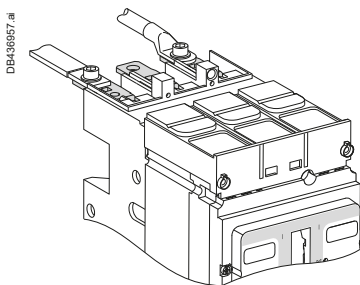

ComPacT NSX Power Connections

ComPacT NSX100 to 630 with/without VigiPacT Add-on Plug-in and Withdrawable Versions

Connection with Accessories

Bare-Cable Connectors: Mounting on Backplate (M) or Rails (V)

NSX100 to 250

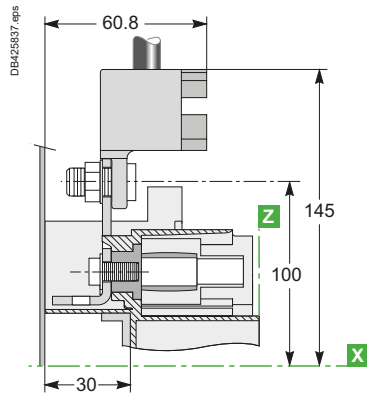
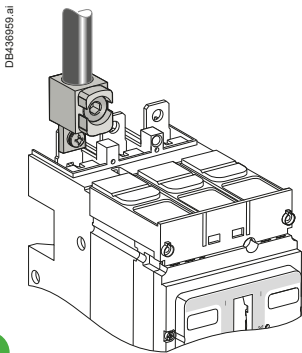
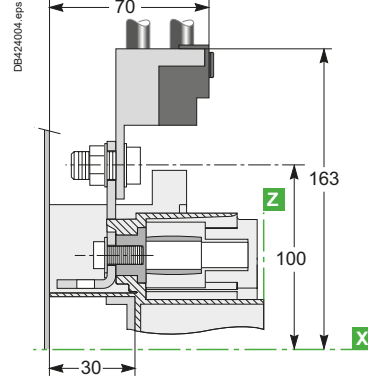
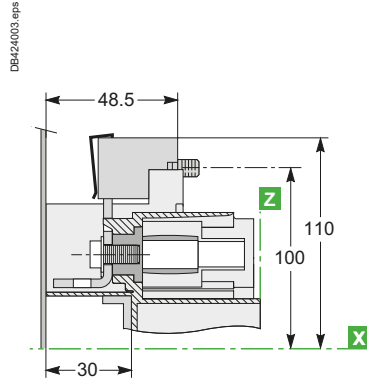
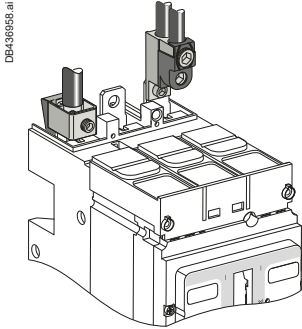

NSX400/630

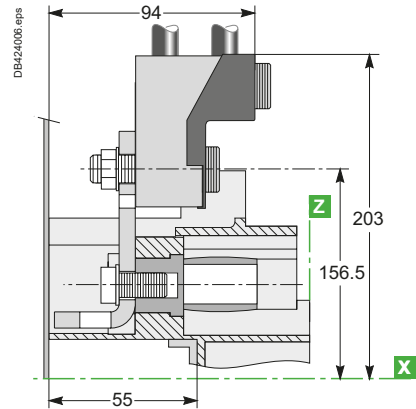
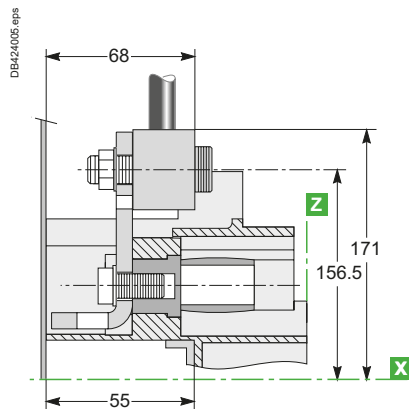
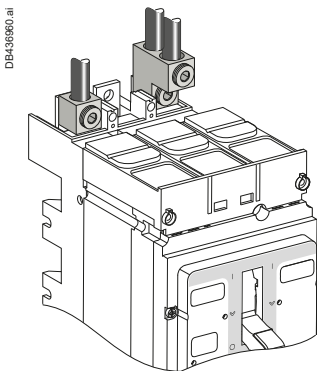

Bare-Cable Connectors: Mounting Through Front Panel (N) or on Rails (V)

NSX100 to 250

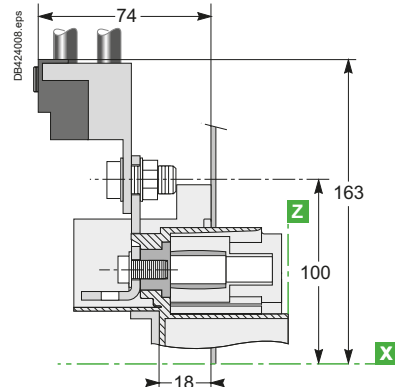
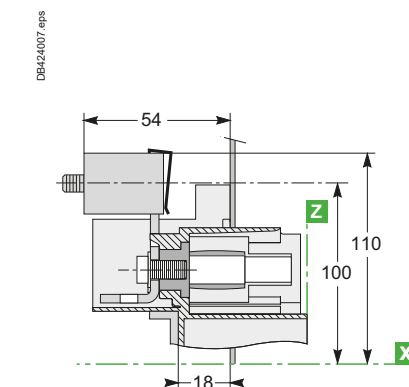
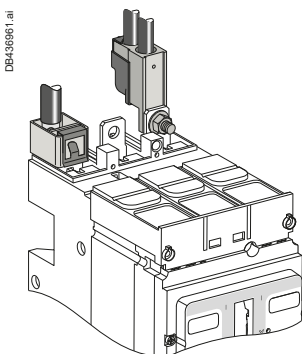

ComPacT NSX Power Connections

ComPacT NSX100 to 630 with/without VigiPacT Add-on Plug-in and Withdrawable Versions

Bare-Cable Connectors: Mounting Through Front Panel (N) or on Rails (V)

NSX400/630

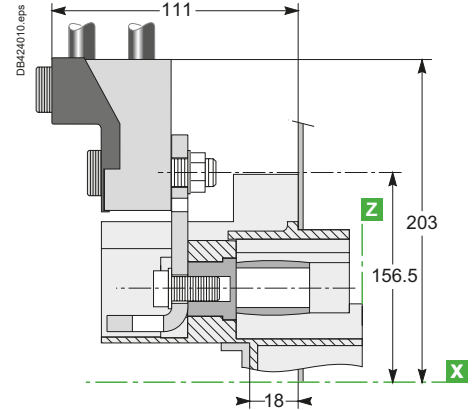
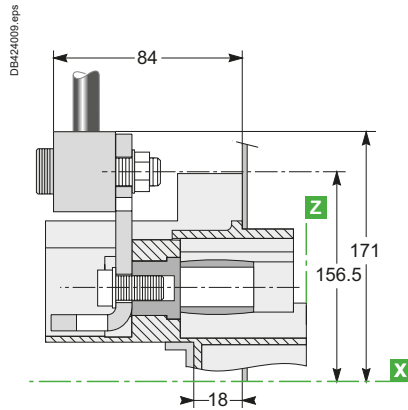
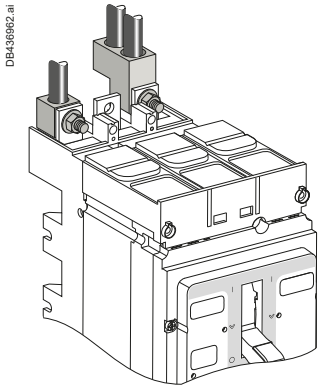

Connection with Accessories

45° Extensions: Mounting Through Front Panel (N) or on Rails (V)

NSX100 to 250

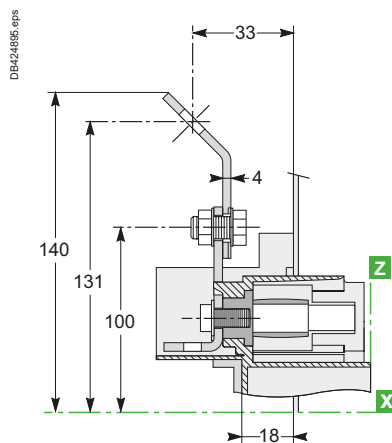
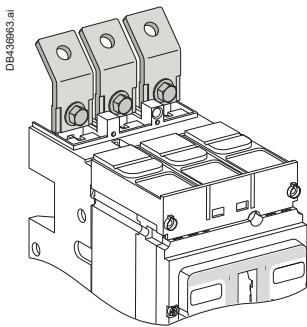

NSX400/630

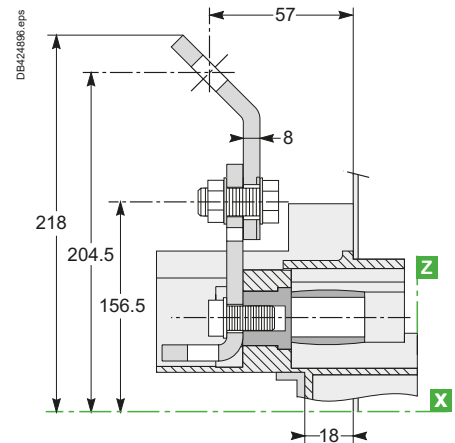

Double-L Extensions: Mounting on Backplate (M) or Rails (V)

NSX100 to 250

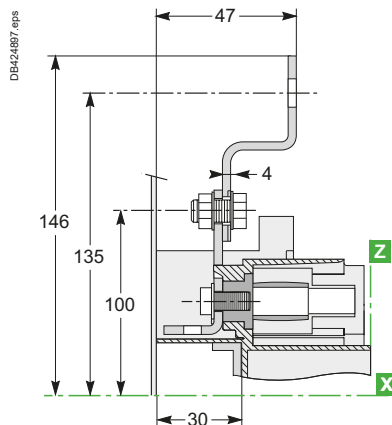
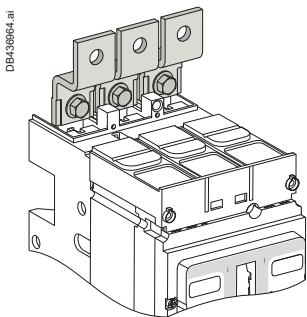

Double-L Extensions: Mounting Through Front Panel (N) or on Rails (V)

NSX100 to 250

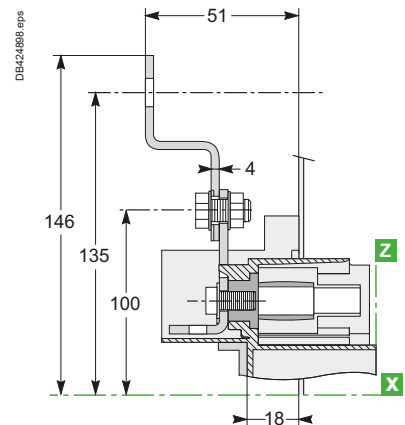

ComPacT NSX Power Connections

ComPacT NSX100 to 630 with/without VigiPacT Add-on Plug-in and Withdrawable Versions

Connection with Accessories

Spreaders: Mounting on Backplate (M) or Rails (V)

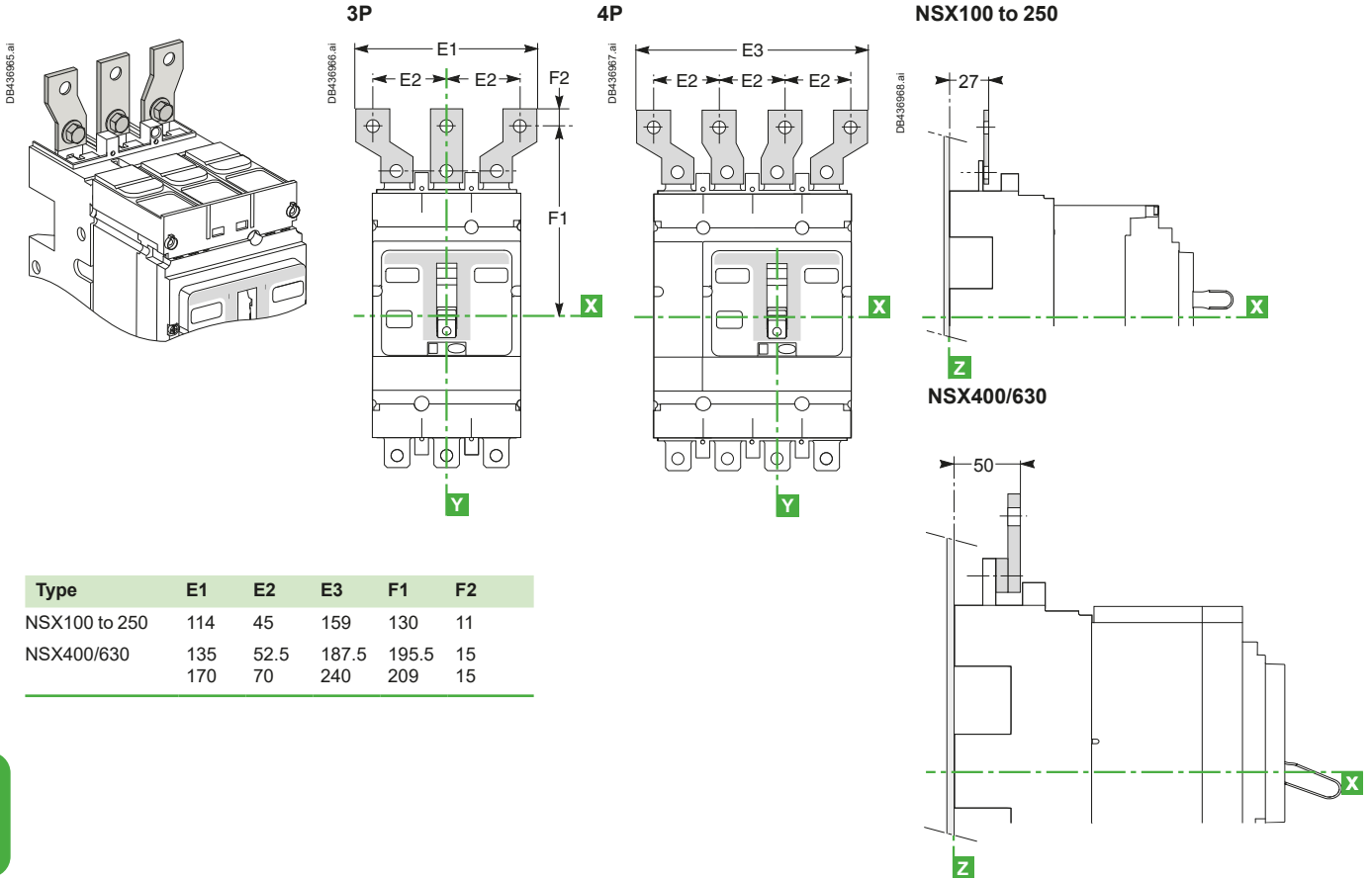

E

Long Insulated Rear Connectors: Mounting on Backplate (M) or Rails (V)

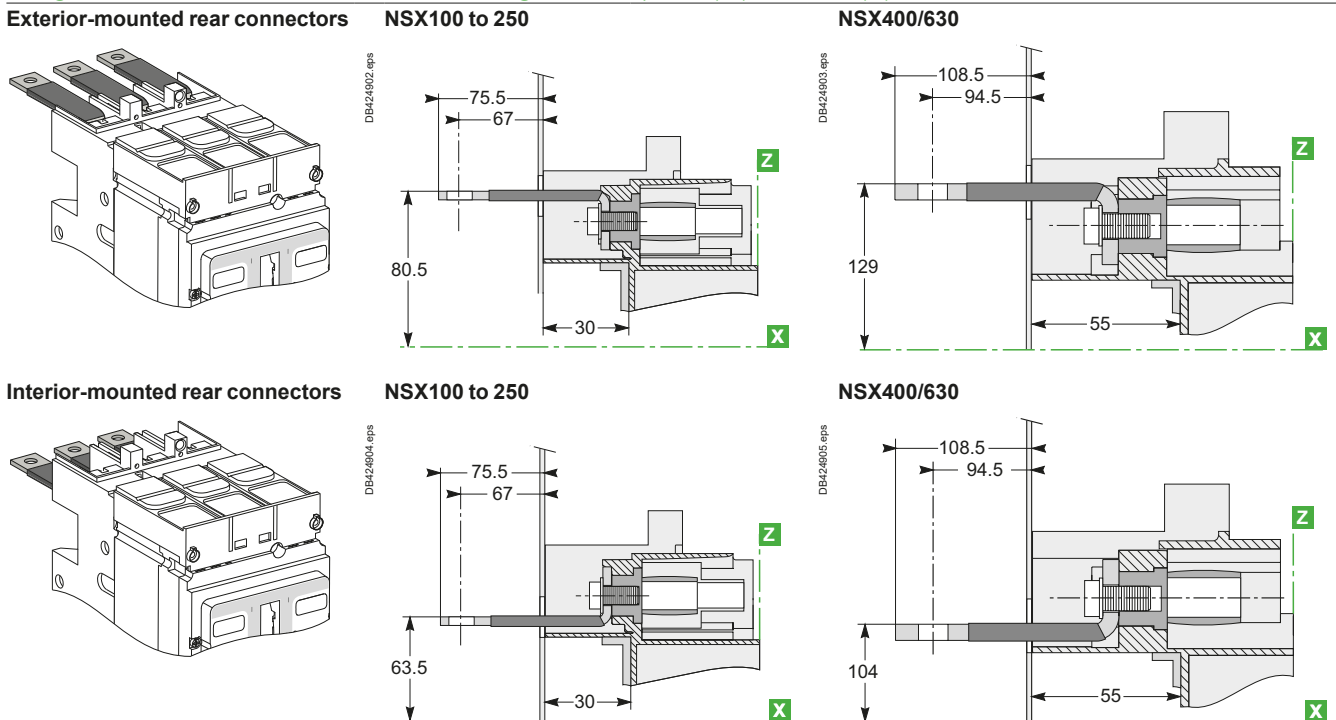

Long, insulated connectors are mandatory.

ComPacT NSX Power Connections

Connection of Insulated Bars or Cables with Lugs to ComPacT NSX100 to 630 with/without VigiPacT Add-on

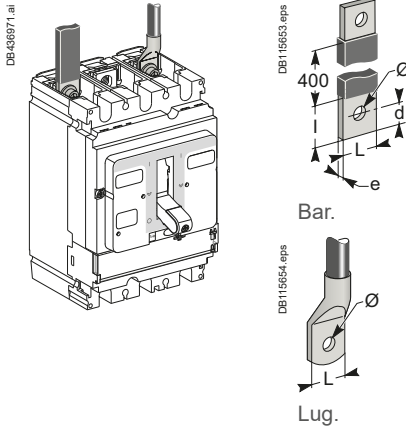

Direct Connection for NSX100 to 630

Dimensions		NSX100	NSX160/250	NSX400/630
Bars	L (mm)	≤ 25	≤ 25	≤ 32
	l (mm)	d + 10	d + 10	d + 15
	d (mm)	≤ 10	≤ 10	≤ 15
	e (mm)	≤ 6	≤ 6	3 ≤ e ≤ 10
	Ø (mm)	6.5	8.5	10.5
Lugs	L (mm)	≤ 25	≤ 25	≤ 32
	Ø (mm)	6.5	8.5	10.5
Torque (Nm) [1]		10	15	50
Torque (Nm) [2]		5/5	5/5	20/11
Torque (Nm) [3]		8	8	20

- [1] Tightening torque on the circuit breaker for lugs or bars.
- [2] Tightening torque on fixed devices for rear connectors//tightening torque on plug-in or withdrawable devices for power connectors.
- [3] Tightening torque on the plug-in base for terminal extensions.

Accessories for NSX100 to 250

Straight terminal extensions

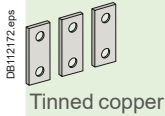

Double-L terminal extensions

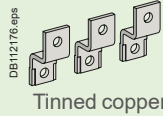

Spreaders: separate parts

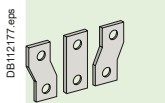

one-piece spreader

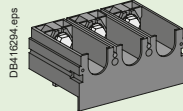

For U > 500 V, the mandatory insulation kit is not compatible with spreaders made up of separate parts. The one-piece spreader must be used.

Connection with Accessories for NSX100 to 250 (60228)

Pole pitch

Without spreaders	35 mm
With spreaders	45 mm

Dimensions		With spreaders or terminal extensions	
		NSX100	NSX160/250

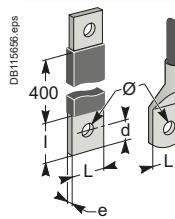

Bars	L (mm)	≤ 25	≤ 25
	l (mm)	20 ≤ l ≤ 25	20 ≤ l ≤ 25
	d (mm)	≤ 10	≤ 10
	e (mm)	≤ 6	≤ 6
	Ø (mm)	6.5	8.5
Lugs	L (mm)	≤ 25	≤ 25
	Ø (mm)	6.5	8.5
Torque (Nm) [1]		10	15
Torque (Nm) [2]		5	5

- [1] Tightening torque on the circuit breaker for spreaders or terminal extensions.
- [2] Tightening torque on the plug-in base for spreaders or terminal extensions.

Spreaders and straight, right-angle, 45°, double-L and edgewise terminal extensions are supplied with flexible interphase barriers.

Accessories for NSX400 and 630

Spreaders made up of separate parts for 52.5 and 70 mm pitch

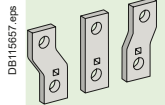

For U > 500 V, use of the 52.5 mm pitch spreaders requires a specific insulation kit. The 70 mm pitch spreaders may not be used.

Connection with Accessories for NSX400 and 630 (60228)

Pole pitch

Without spreaders	45 mm
With spreaders	52.5 or 70 mm

Dimensions		With spreaders	With terminal extensions
------------	--	----------------	--------------------------

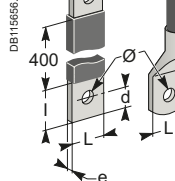

Bars	L (mm)	≤ 40	≤ 32
	l (mm)	d + 15	30 ≤ l ≤ 34
	d (mm)	≤ 20	≤ 15
	e (mm)	3 ≤ e ≤ 10	3 ≤ e ≤ 10
	Ø (mm)	12.5	10.5
Lugs	L (mm)	≤ 40	≤ 32
	Ø (mm)	12.5	10.5
Torque (Nm) [1]		50	50
Torque (Nm) [2]		20	20

- [1] Tightening torque on the circuit breaker for spreaders or terminal extensions.
- [2] Tightening torque on the plug-in base for spreaders or terminal extensions.

Spreaders and right-angle, 45° and edgewise terminal extensions are supplied with flexible interphase barriers.

Accessories for NSX100 to 630

Right-angle terminal extensions

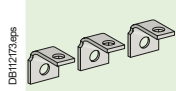

Edgewise terminal extensions



45° terminal extensions

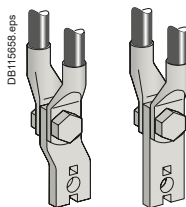

Mounting detail: 2 cables with lugs.

ComPacT NSX Main Power Connections

This information applies when connecting cables (with all types of connection/accessories) to ComPacT NSX100 to 630:

- VigiPacT add-on
- Plug-in base
- Current transformer module
- PowerTag module

Conductor Materials and Electrodynamic Stresses

ComPacT NSX circuit breakers can be connected indifferently with bare-copper, tinned-copper and tinned-aluminium conductors (flexible or rigid bars, cables).

In the event of a short-circuit, thermal and electrodynamic stresses will be exerted on the conductors. They must therefore be correctly sized and held in place by supports. It is the responsibility of panel builders to have electrodynamic stresses confirmed by Icc tests complying with IEC 61439.

Electrical connection points on switchgear devices (switch-disconnectors, contactors, circuit breakers, etc.) must not be used for mechanical support. Any partition between upstream and downstream connections of the device must be made of non-magnetic material.

Note: Having a gap when assembling the conductors is a normal behavior.

The diagram is shown with circuits de-energized, relays in normal position, and all devices open, connected, and charged. Terminal connections shown as **O** must be connected by the customer.

Indication Contacts

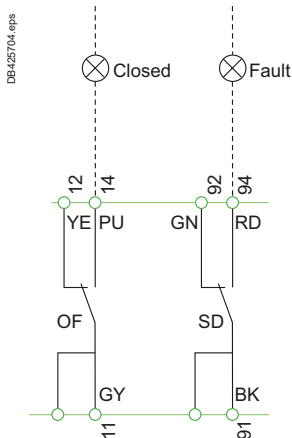

Indication Contacts

- OF** Device ON/OFF indication contacts
- SD** Trip indication contact

Color Code for Auxiliary Wiring

- BK:** Black
- GN:** Green
- GY:** Grey
- RD:** Red
- PU:** Purple
- YE:** Yellow

Remote Operation

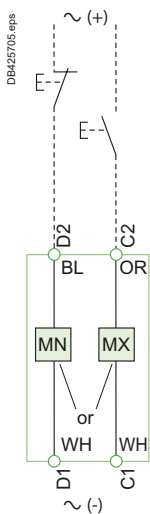

Remote Operation

- MN** Undervoltage Release
- or
- MX** Shunt trip Release

Color Code for Auxiliary Wiring

- BL:** Blue
- OR:** Orange
- WH:** White



ComPacT NSXm

SDx Module for MicroLogic Vigi 4.1 (ELCB)

The diagram is shown with circuits de-energized, all devices open, connected and charged and relays in normal position.

Connection

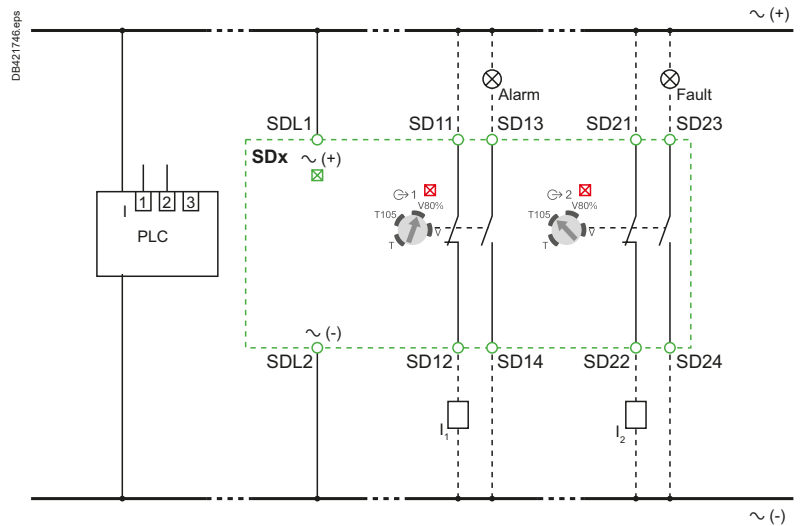

Operation

E

- I: charge current
- SDT105: overload alarm
- SDT: overload trip indication
- $I_{\Delta n}$: earth leakage current
- SDV80: earth leakage alarm
- SDV: earth leakage trip indication
- Q: circuit breaker

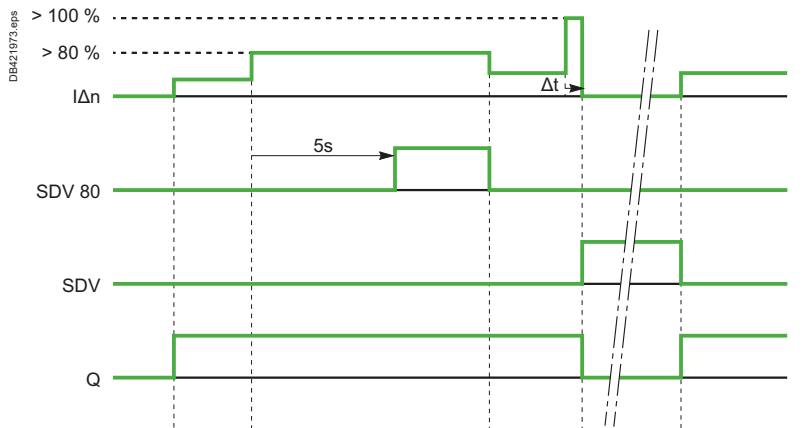
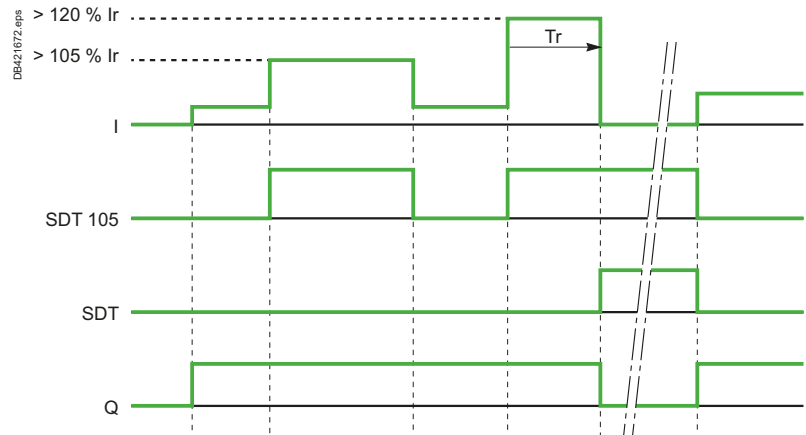

Switchboard Integration

ComPacT NSX

Fixed Circuit Breakers

Power

MicroLogic

Remote Operation

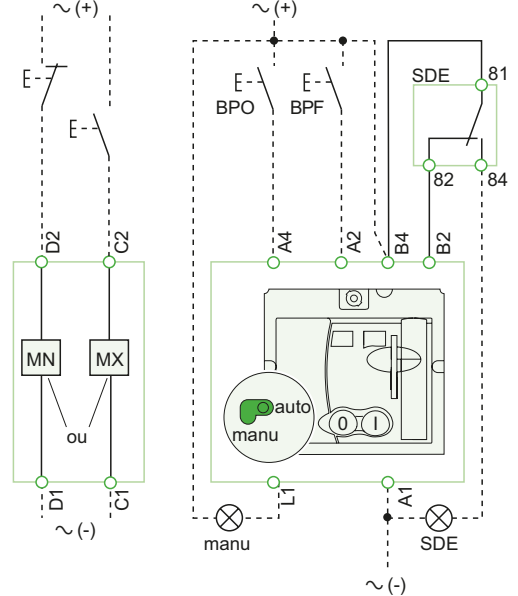
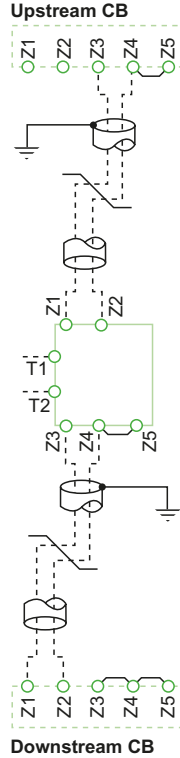
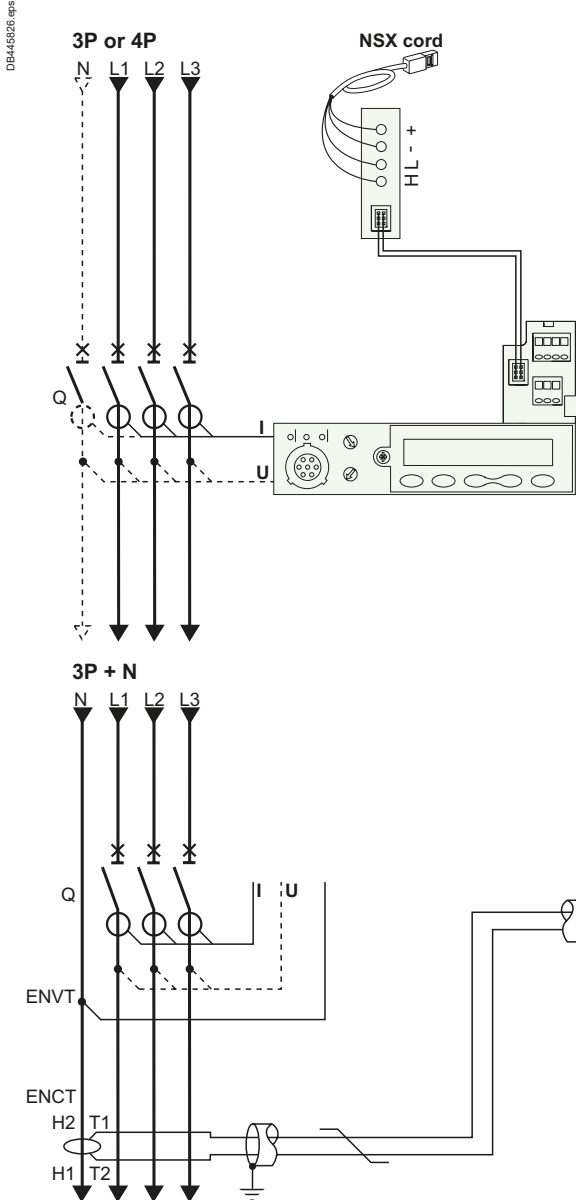

Motor mechanism (MT)

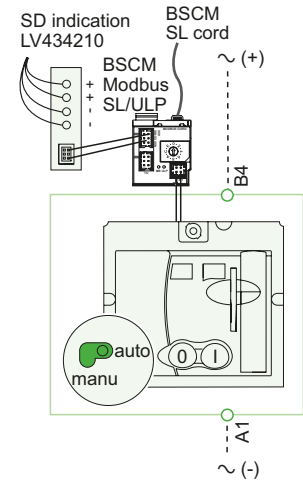

Communicating motor mechanism (MTc)

MicroLogic E

Communication

H(WH), L(BL): data
 - (BK), + (RD): 24 V DC power supply

ZSI (Zone Selective Interlocking)

- Z1: ZSI OUT SOURCE
- Z2: ZSI OUT
- Z3: ZSI IN SOURCE
- Z4: ZSI IN ST (short time)
- Z5: ZSI IN GF (ground fault)

Note: Z3, Z4, Z5 for NSX400/630 only.

ENCT: external neutral current transformer:

- shielded cable with 1 twisted pair (T1, T2)
- shielding earthed at one end only (CT end).

Connection L = 30 cm max.

- maximum length of 10 metres
- cable size 0.4 to 1.5 mm²

- recommended cable: Belden 8441 or equivalent.

ENVT: external neutral voltage tap for connection to the neutral via a 3P circuit breaker.

Remote operation

MN: undervoltage release

or

MX: shunt release

Motor mechanism (MT)

- A4:** opening order
- A2:** closing order
- B4, A1:** power supply to motor mechanism for indication purpose only
- L1:** manual position (manu) for indication purpose only
- B2:** SDE interlocking (mandatory for correct operation)
- BPO:** opening pushbutton
- BPF:** closing pushbutton

Communicating motor mechanism (MTc)

- B4, A1:** motor mechanism power supply
- BSCM Modbus SL/ULP:** breaker status and control module



Indication Contacts

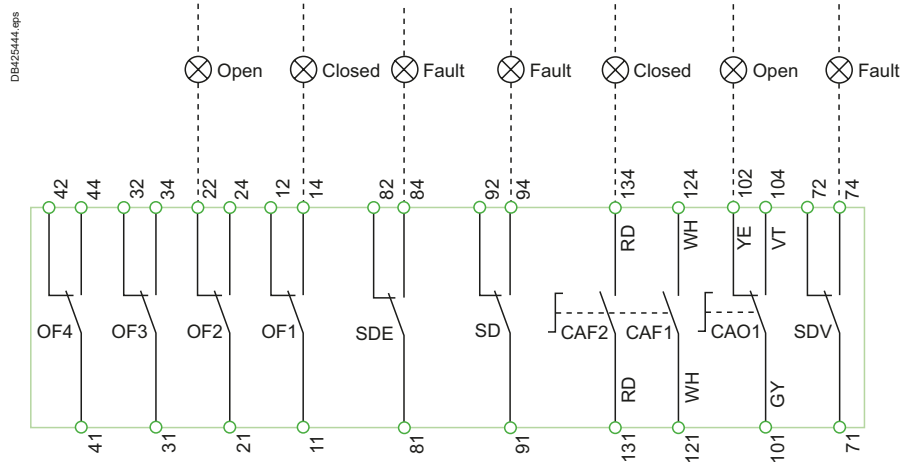

The diagram is shown with circuits de-energized, all devices open, connected and charged and relays in normal position. Terminals shown in green **O** must be connected by the customer.

Indication Contacts

- OF2/OF1:** device ON/OFF indication contacts
- OF4/OF3:** device ON/OFF indication contacts (NSX400/630)
- SDE:** fault-trip indication contact (short-circuit, overload, ground fault, earth leakage)
- SD:** trip-indication contact
- CAF2/CAF1:** early-make contact (rotary handle only)
- CAO1:** early-break contact (rotary handle only)
- SDV:** earth leakage fault trip indication contact (VigiPacT add-on)

Color Code for Auxiliary Wiring

- | | |
|-------------------|-------------------|
| RD: red | VT: violet |
| WH: white | GY: grey |
| YE: yellow | OR: orange |
| BK: black | BL: blue |
| GN: green | |

ComPacT NSX Plug-in/Withdrawable Circuit Breakers

The diagram is shown with circuits de-energized, all devices open, connected and charged and relays in normal position.

Power

MicroLogic

Remote Operation

DB445827 eps

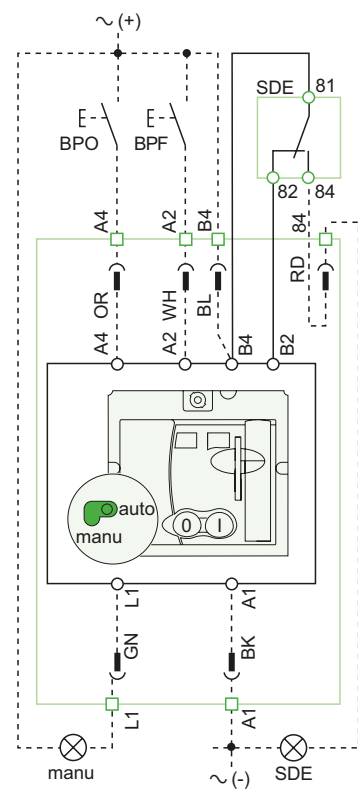
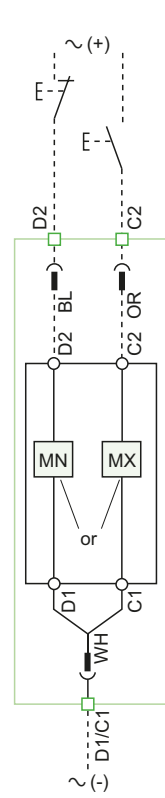
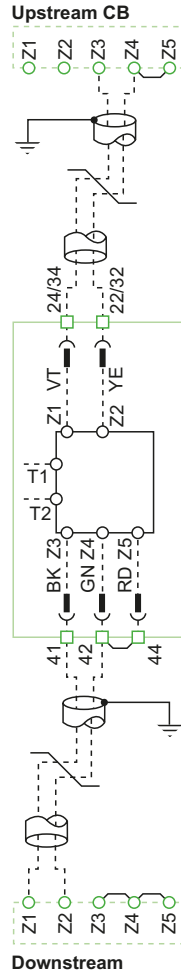
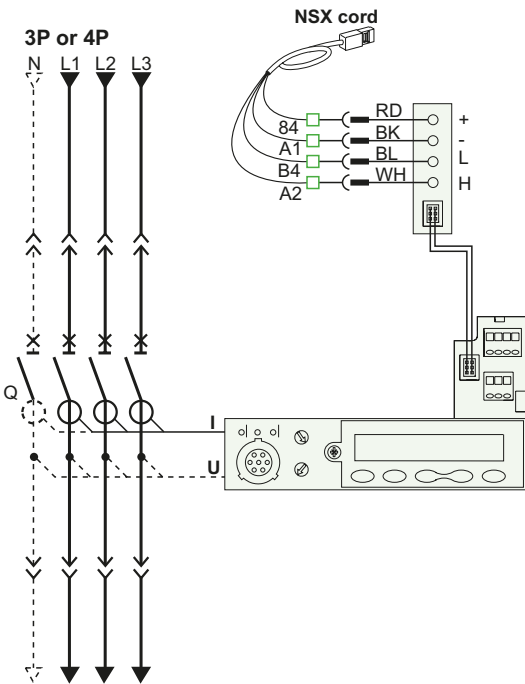

Motor mechanism (MT)

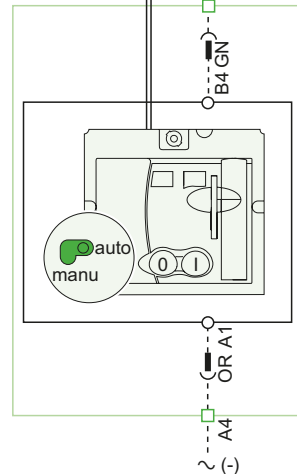
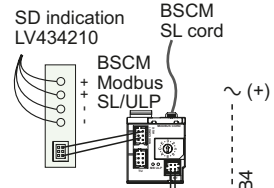

Communicating motor mechanism (MTc)

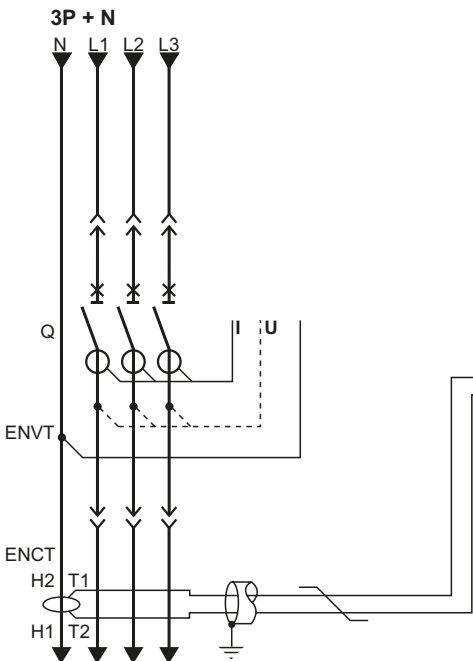

ComPacT NSX

Plug-in/Withdrawable Circuit Breakers

Indication Contacts

Carriage Switches

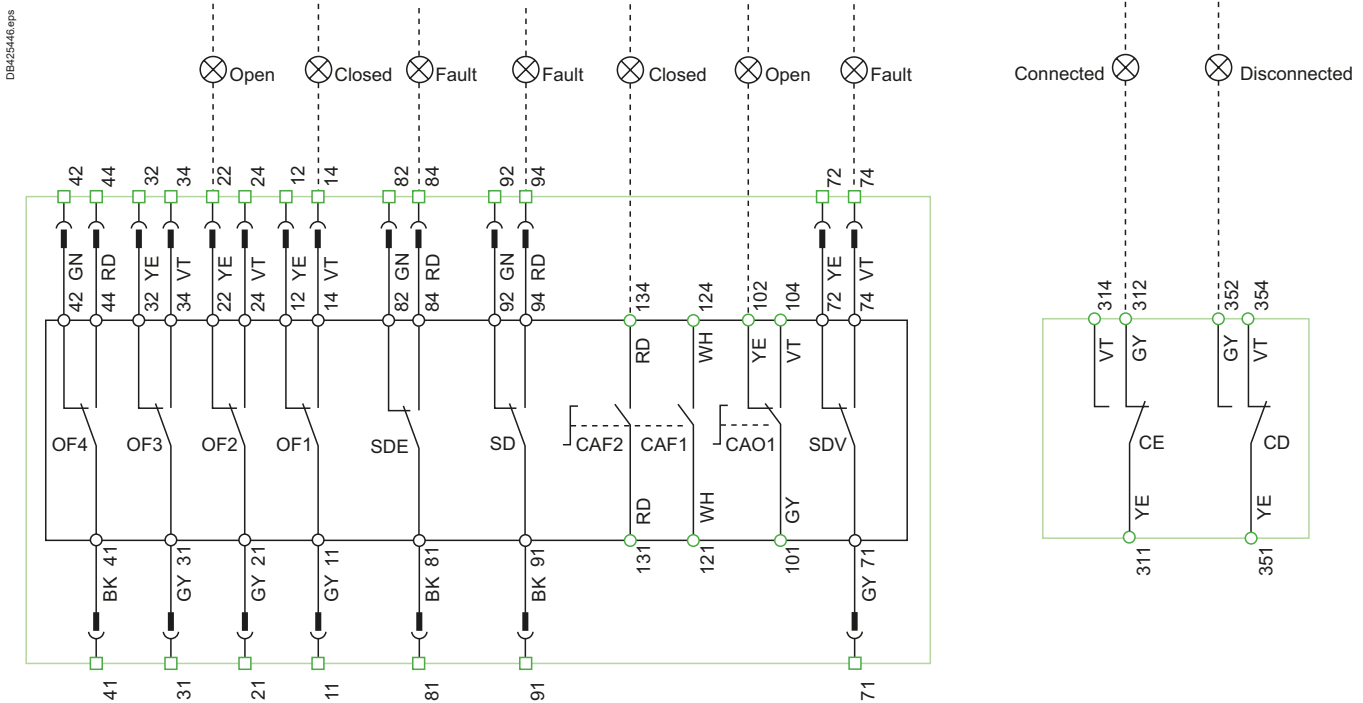

E

MicroLogic E

Communication

H(WH), L(BL): data
 - (BK), + (RD): 24 V DC power supply

ZS1 (Zone Selective Interlocking)

Z1: ZSI OUT SOURCE

Z2: ZSI OUT

Z3: ZSI IN SOURCE

Z4: ZSI IN ST (short time)

Z5: ZSI IN GF (ground fault)

Note: Z3, Z4, Z5 for NSX400/630 only.

ENCT: external neutral current transformer:

- shielded cable with 1 twisted pair (T1, T2)
- shielding earthed at one end only (CT end).

Connection L = 30 cm max.

- maximum length of 10 metres
- cable size 0.4 to 1.5 mm²
- recommended cable: Belden 8441 or equivalent.

ENVNT: external neutral voltage tap for connection to the neutral via a 3P circuit breaker.

Color code for auxiliary wiring

RD: red	VT: violet
WH: white	GY: grey
YE: yellow	OR: orange
BK: black	BL: blue
GN: green	

Terminals shown in green □/○ must be connected by the customer.

Remote operation

MN: undervoltage release

or

MX: shunt release

Motor mechanism (MT)

A4: opening order

A2: closing order

B4, A1: motor mechanism power supply

L1: manual position (manu) for indication purpose only

B2: SDE interlocking (mandatory for automatic or remote recharging)

BPO: opening pushbutton

BPF: closing pushbutton

Communicating motor mechanism (MTc)

B4, A1: motor mechanism power supply

BSCM Mobdus SL/ULP: breaker status and control module

Indication contacts

OF2/OF1: device ON/OFF indication contacts

OF4/OF3: device ON/OFF indication contacts (NSX400/630)

SDE: fault-trip indication contact

(short-circuit, overload, ground fault, earth leakage)

SD: trip-indication contact

CAF2/CAF1: early-make contact (rotary handle only)

CAO1: early-break contact (rotary handle only)

SDV: earth leakage fault trip indication contact (VigiPacT add-on)

The diagram is shown with circuits de-energized, all devices open, connected and charged and relays in normal position.

After tripping initiated by the "Push to trip" button or by the undervoltage (MN) release or the shunt (MX) release, device reset can be automatic, remote or manual.

Following tripping due to an electrical fault (with an SDE contact), reset must be carried out manually.

Motor mechanism (MT) with automatic reset

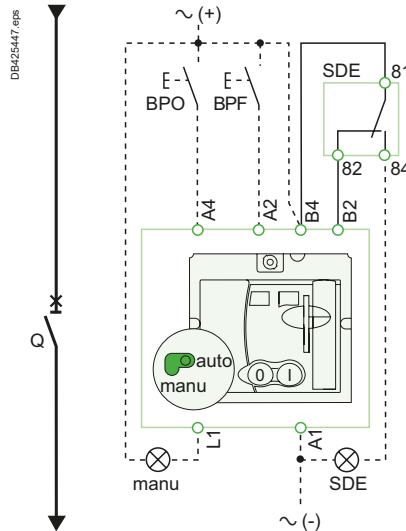

Motor mechanism (MT) with remote reset

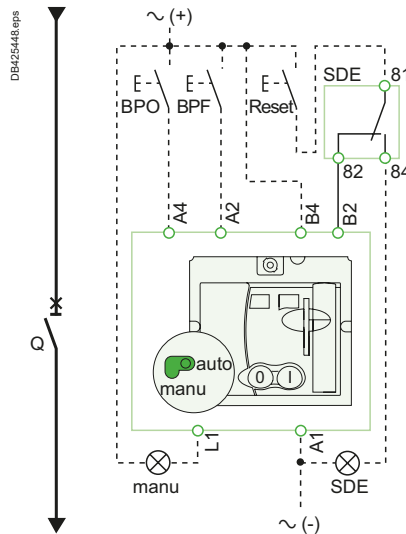

Motor mechanism (MT) with manual reset

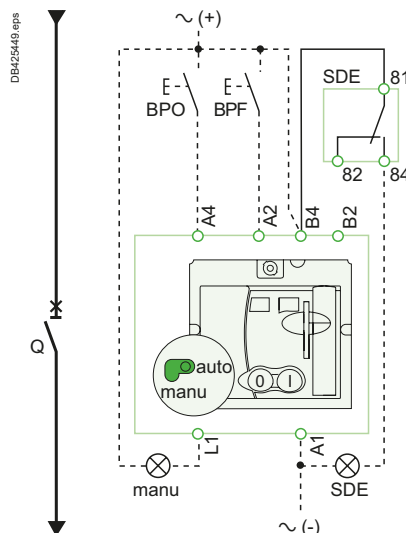

Symbols

- Q:** circuit breaker
- A4:** opening order
- A2:** closing order
- B4, A1:** motor mechanism power supply
- L1:** manual position (manu) for indication purpose only
- B2:** SDE interlocking (mandatory for correct operation)
- BPO:** opening pushbutton
- BPF:** closing pushbutton
- SDE:** fault-trip indication contact (short-circuit, overload, ground fault, earth leakage)



ComPacT NSX Motor Mechanism

Communicating motor mechanism (MTC)

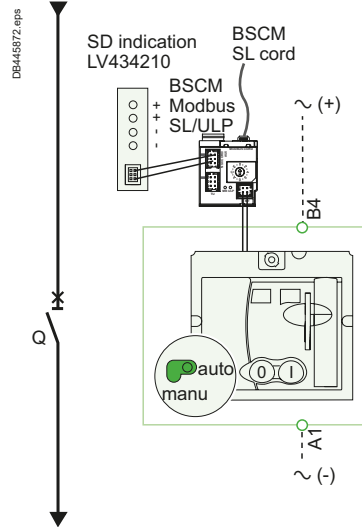

Schematic representation of the communicating motor mechanism (MT).

Single-line diagram of communicating motor mechanism

Opening, closing and reset orders are transmitted via the communication network. The "Enable automatic reset" and "Enable reset even if SDE" parameters must be set using the EcoStruxure Power Commission software via the screen by clicking the blue text.

"Auto/manu" is a switch on the front of the motor mechanism.

Symbols

Q:	circuit breaker
B4, A1:	motor mechanism power supply
BSCM Modbus SL/ULP:	breaker status and control module

Terminals shown in green ○ must be connected by the customer.



The diagram is shown with circuits de-energized, all devices open, connected and charged and relays in normal position.

Connection

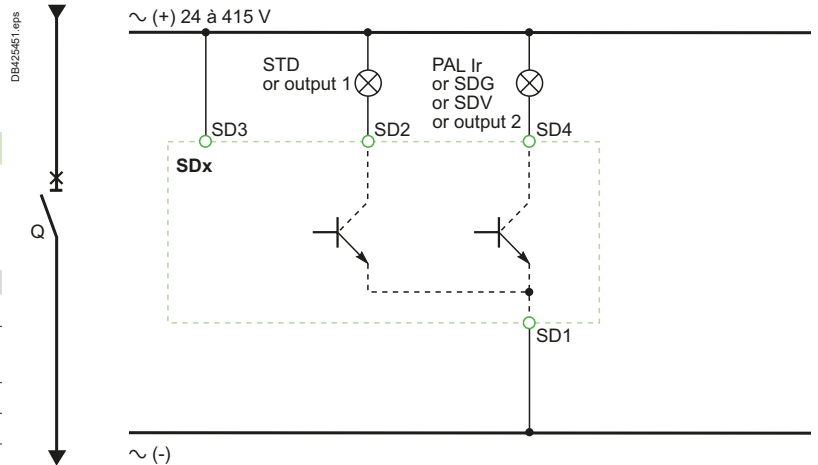

Symbols

SD1, SD3: SDx-module power supply
SD2: output 1 (80 mA max.)
SD4: output 2 (80 mA max.)

	SD2	SD4
MicroLogic 2	SDT	-
MicroLogic Vigi 4	SDT	SDV
MicroLogic 5	SDT or output 1	PAL Ir or output 2
MicroLogic 6	SDT or output 1	SDG or output 2
MicroLogic Vigi 7	SDT or output 1	SDV or output 2

Terminals shown in green **O** must be connected by the customer.

Operation

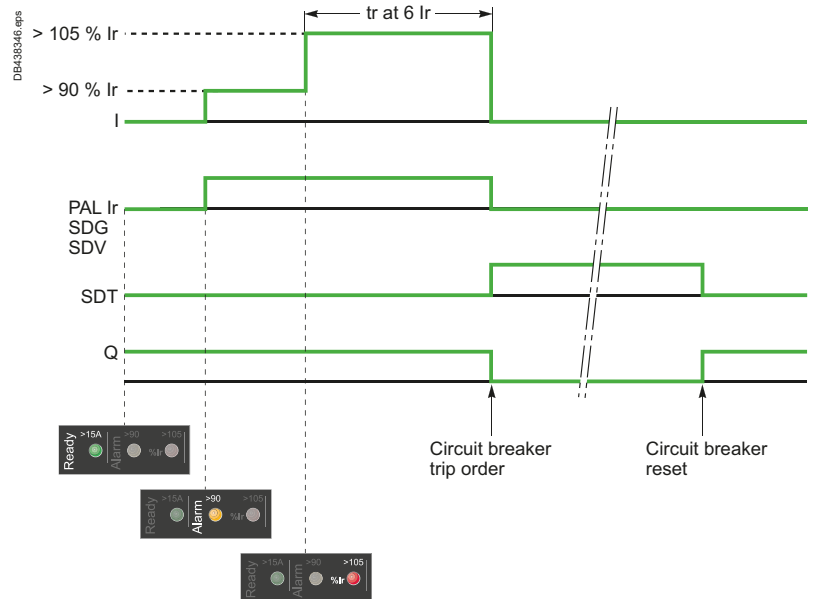

- I:** charge current
- PAL Ir:** thermal overload pre-alarm
- SDG:** ground-fault signal
- SDT:** thermal-fault signal
- SDV:** residual current trip signal
- Q:** circuit breaker



ComPacT NSX SDTAM Module with MicroLogic M

The diagram is shown with circuits de-energized, all devices open, connected and charged and relays in normal position.

Symbols

- SD1, SD3:** SDTAM-module power supply
- SD2:** thermal-fault signal output (80 mA max.)
- SD4:** contactor-control output (80 mA max.)

	SD2	SD4
MicroLogic 2-M	SDT	KA1
MicroLogic 6 E-M	SDT	KA1

Terminals shown in green ○ must be connected by the customer.

Connection

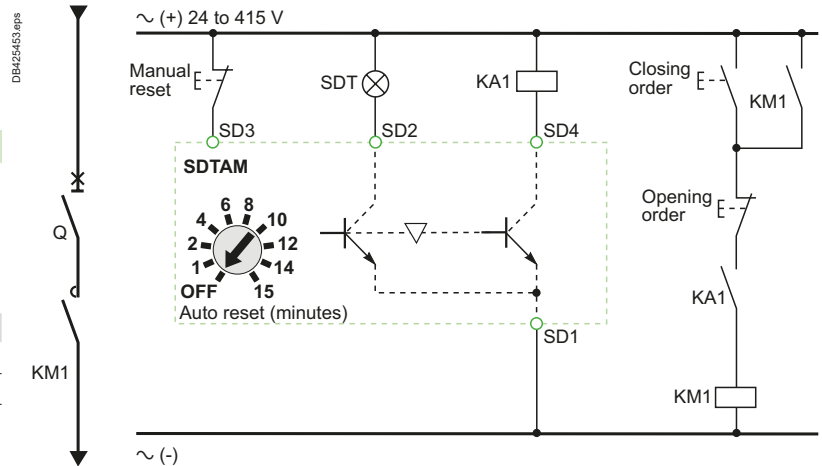

Operation

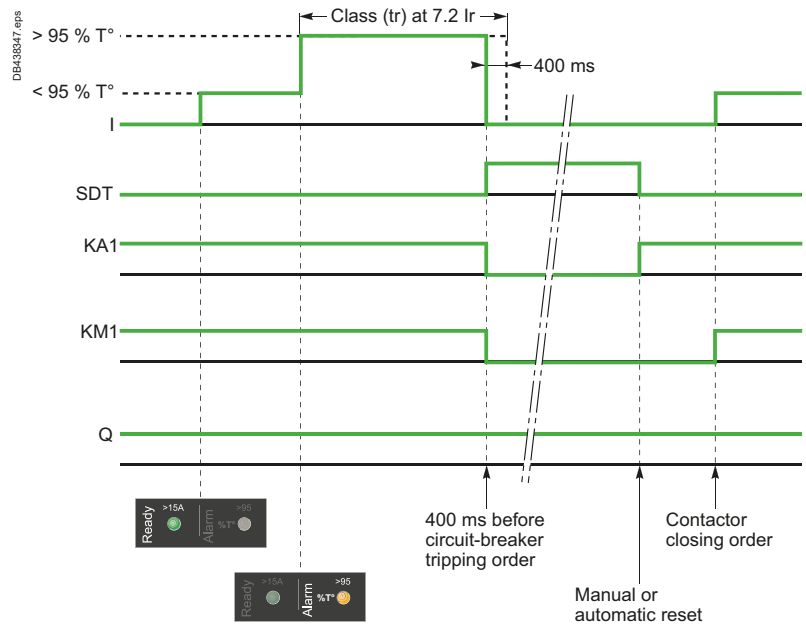

- I:** charge current
- SDT:** thermal-fault signal
- KA1:** auxiliary relay (e.g. RBN or RTBT relay)
- KM1:** motor contactor
- Q:** circuit breaker

ULP (Universal Logic Plug) System and Power Supply Wiring for a ComPacT NSX

DB446922.ai

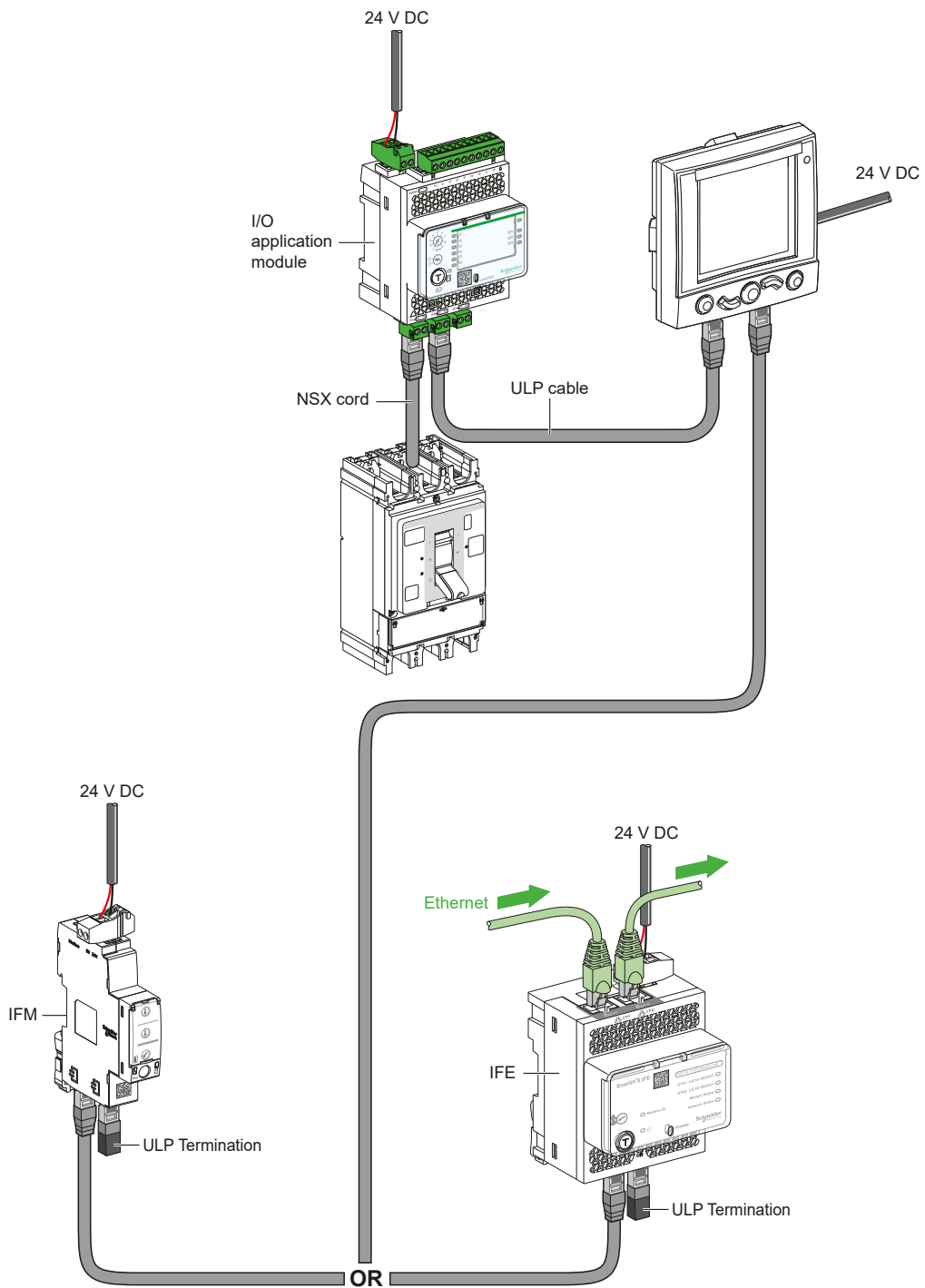

ComPacT NSX Communication

Connection of Circuit Breakers to the Modbus Communication Network

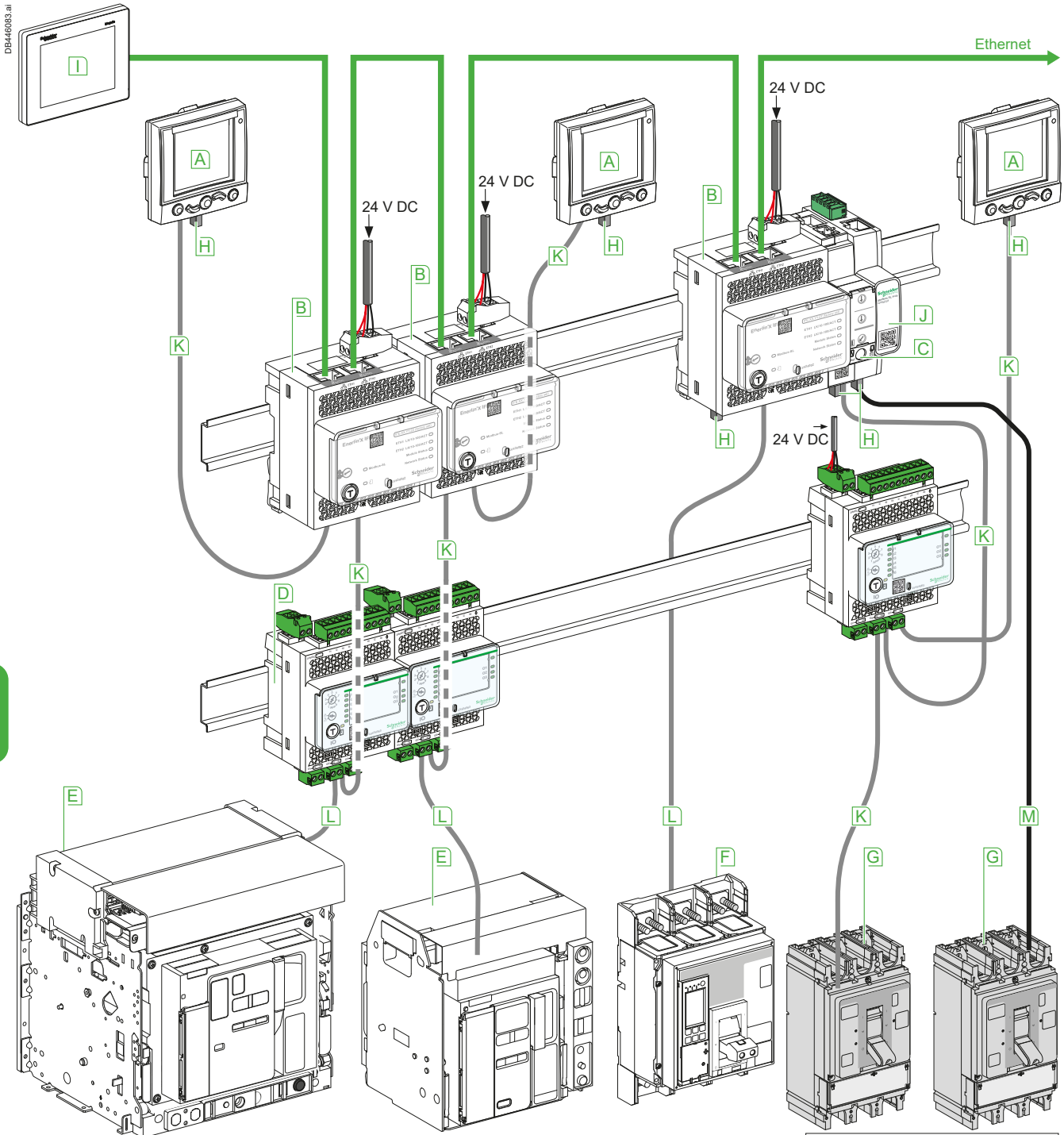

- A** FDM121 (TRV00121)
- B** IFE interface (LV434002)
- C** IFM (LV484000)
- D** I/O application module (LV434063)
- E** MasterPact MTZ
- F** ComPact NS630b-3200
- G** ComPact NSX
- H** ULP termination (TRV00880)
- I** FDM128 (LV434128)
- J** Modbus Hub

- K** ULP cable
- L** Breaker ULP cord
- M** BSCM SL cord
- Ethernet
- Modbus

E

Order your ComPacT NSX and NSXm Through Digital Tools Product Selector

To select ComPacT NSX and NSXm products, use the Product Selector tool available at <https://www.se.com/ww/en/work/support/product-selector/>

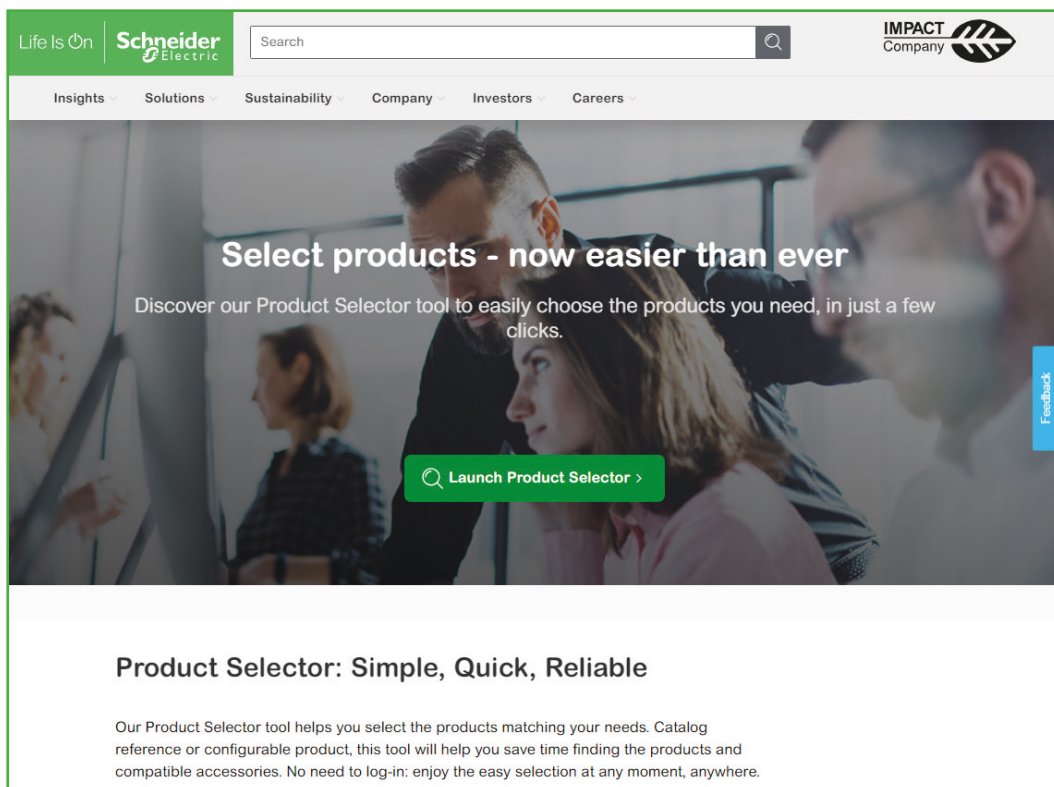

The screenshot shows the Schneider Electric website header with the 'Life Is On' slogan and the 'Schneider Electric' logo. A search bar is present with the word 'Search' inside. To the right of the search bar is the 'IMPACT Company' logo. Below the header is a navigation menu with links for 'Insights', 'Solutions', 'Sustainability', 'Company', 'Investors', and 'Careers'. The main content area features a large image of three people in a meeting. Overlaid on this image is the text 'Select products - now easier than ever' and 'Discover our Product Selector tool to easily choose the products you need, in just a few clicks.' Below this text is a green button with a magnifying glass icon and the text 'Launch Product Selector >'. A blue 'Feedback' button is visible on the right side of the image. Below the image is a white section with the heading 'Product Selector: Simple, Quick, Reliable' and a paragraph of text: 'Our Product Selector tool helps you select the products matching your needs. Catalog reference or configurable product, this tool will help you save time finding the products and compatible accessories. No need to log-in: enjoy the easy selection at any moment, anywhere.'



The product selector is also available from [NSXm product range page](#) or [NSX product range page](#) on www.se.com.

E

Catalog Numbers

ComPacT NSXm.....	F-3
ComPacT NSX100-250	F-15
ComPacT NSX400-630	F-49
Source-Changeover Systems for 2 Devices ComPacT NSX100 to NSX630.....	F-71
NSX100/400 for Utilities, "Tarif Jaune" Public Distribution	F-73
Order Form	F-76

Other Chapters

Select Circuit Breakers and Switch-Disconnectors	A-1
Select Protection	B-1
Customize Circuit Breakers with Accessories.....	C-1
Smart Panel Integration	D-1
Switchboard Integration.....	E-1
Glossary	G-1
Additional Characteristics.....	H-1

New generation, simpler commercial references

New meaningful references to make your life easier

We know any change in commercial references will be an adjustment, but in the long run we believe this change is needed, and will make your life easier.

The table below describes how new references are build.

For instance LV429630 (ComPacT Breaker NSX100F 36kA AC 3P3D 100A TMD) becomes **C10F3TM100**.

ComPacT type	Frame rating	Breaking capacity	Number of poles	Trip unit	Trip unit ratings	Suffix
NSX = C	63m = 11	16kA = E	1P = 1	TMD = TM	16 = 016	EverLink = L
NSXm = C	160m = 12	25kA = B	2P = 2	MA = MA	20 = 020	Busbar = B
	100 = 10	36kA = F	3P3D = 3	TMG = MG	25 = 025	Fixed = F
	160 = 16	50kA = N	4P4D = 4	1.3 M = 1M	30 = 030	DC = D
	250 = 25	70kA = H	3P2D = 5	2.2 = 2D	40 = 040	Switch = S
	400 = 40	100kA = S	4P3D = 6	2.3 = 2D	50 = 050	DC PV = DP
	630 = 63	150kA = L		4.1 = 4V	63 = 063	
		...		4.2 = 4V	80 = 080	Acc with ID
				...	100 = 100	change = T
					...	

F



Catalog Numbers: ComPacT NSXm

Complete Fixed Device

ComPacT NSXm E/B (16/25 KA at 380/415 V).....	F-4
ComPacT NSXm F/N (36/50 KA at 380/415 V).....	F-5
ComPacT NSXm H (70 KA at 380/415 V).....	F-6
ComPacT NSXm MicroLogic Vigi 4.1 E/B/F (16/25/36 KA at 380/415 V).....	F-7
ComPacT NSXm MicroLogic Vigi 4.1 N/H (50/70 KA at 380/415 V).....	F-8
ComPacT NSXm NA	F-9

Accessories

Connection and Insulation	F-10
Electrical Auxiliaries	F-11
Rotary Handles, Locks, Seals, Indication and Measurements	F-12
Spare Parts, Test Tool and Software	F-13

Other Chapters	
Select Circuit Breakers and Switch-Disconnectors	A-1
Select Protection	B-1
Customize Circuit Breakers with Accessories.....	C-1
Smart Panel Integration	D-1
Switchboard Integration.....	E-1
Glossary	G-1
Additional Characteristics.....	H-1

Complete Fixed Device

ComPacT NSXm E/B (16/25 KA at 380/415 V)

ComPacT NSXm E (16 KA at 380/415 V)

With thermal-magnetic trip unit TM-D

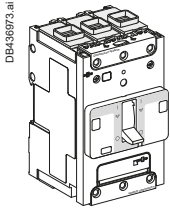

EverLink™ connectors

Rating	3P	4P 3d	4P 4d
TM16D	C11E3TM016L	C11E6TM016L	C11E4TM016L
TM25D	C11E3TM025L	C11E6TM025L	C11E4TM025L
TM32D	C11E3TM032L	C11E6TM032L	C11E4TM032L
TM40D	C11E3TM040L	C11E6TM040L	C11E4TM040L
TM50D	C11E3TM050L	C11E6TM050L	C11E4TM050L
TM63D	C11E3TM063L	C11E6TM063L	C11E4TM063L
TM80D	C11E3TM080L	C11E6TM080L	C11E4TM080L
TM100D	C11E3TM100L	C11E6TM100L	C11E4TM100L
TM125D	C12E3TM125L	C12E6TM125L	C12E4TM125L
TM160D	C12E3TM160L	C12E6TM160L	C12E4TM160L

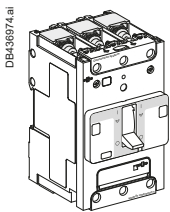

Compression lug/busbar connectors

Rating	3P	4P 3d	4P 4d
TM16D	C11E3TM016B	C11E6TM016B	C11E4TM016B
TM25D	C11E3TM025B	C11E6TM025B	C11E4TM025B
TM32D	C11E3TM032B	C11E6TM032B	C11E4TM032B
TM40D	C11E3TM040B	C11E6TM040B	C11E4TM040B
TM50D	C11E3TM050B	C11E6TM050B	C11E4TM050B
TM63D	C11E3TM063B	C11E6TM063B	C11E4TM063B
TM80D	C11E3TM080B	C11E6TM080B	C11E4TM080B
TM100D	C11E3TM100B	C11E6TM100B	C11E4TM100B
TM125D	C12E3TM125B	C12E6TM125B	C12E4TM125B
TM160D	C12E3TM160B	C12E6TM160B	C12E4TM160B

ComPacT NSXm B (25 KA at 380/415 V)

With thermal-magnetic trip unit TM-D

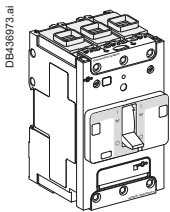

EverLink™ connectors

Rating	3P	4P 3d	4P 4d
TM16D	C11B3TM016L	C11B6TM016L	C11B4TM016L
TM25D	C11B3TM025L	C11B6TM025L	C11B4TM025L
TM32D	C11B3TM032L	C11B6TM032L	C11B4TM032L
TM40D	C11B3TM040L	C11B6TM040L	C11B4TM040L
TM50D	C11B3TM050L	C11B6TM050L	C11B4TM050L
TM63D	C11B3TM063L	C11B6TM063L	C11B4TM063L
TM80D	C11B3TM080L	C11B6TM080L	C11B4TM080L
TM100D	C11B3TM100L	C11B6TM100L	C11B4TM100L
TM125D	C12B3TM125L	C12B6TM125L	C12B4TM125L
TM160D	C12B3TM160L	C12B6TM160L	C12B4TM160L

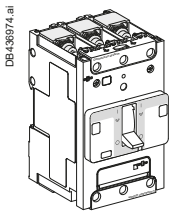

Compression lug/busbar connectors

Rating	3P	4P 3d	4P 4d
TM16D	C11B3TM016B	C11B6TM016B	C11B4TM016B
TM25D	C11B3TM025B	C11B6TM025B	C11B4TM025B
TM32D	C11B3TM032B	C11B6TM032B	C11B4TM032B
TM40D	C11B3TM040B	C11B6TM040B	C11B4TM040B
TM50D	C11B3TM050B	C11B6TM050B	C11B4TM050B
TM63D	C11B3TM063B	C11B6TM063B	C11B4TM063B
TM80D	C11B3TM080B	C11B6TM080B	C11B4TM080B
TM100D	C11B3TM100B	C11B6TM100B	C11B4TM100B
TM125D	C12B3TM125B	C12B6TM125B	C12B4TM125B
TM160D	C12B3TM160B	C12B6TM160B	C12B4TM160B

F

Complete Fixed Device

ComPacT NSXm F/N (36/50 KA at 380/415 V)

ComPacT NSXm F (36 KA at 380/415 V)

With thermal-magnetic trip unit TM-D

DB438973.ai

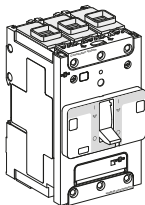

EverLink™ connectors

Rating	3P	4P 3d	4P 4d
TM16D	C11F3TM016L	C11F6TM016L	C11F4TM016L
TM25D	C11F3TM025L	C11F6TM025L	C11F4TM025L
TM32D	C11F3TM032L	C11F6TM032L	C11F4TM032L
TM40D	C11F3TM040L	C11F6TM040L	C11F4TM040L
TM50D	C11F3TM050L	C11F6TM050L	C11F4TM050L
TM63D	C11F3TM063L	C11F6TM063L	C11F4TM063L
TM80D	C11F3TM080L	C11F6TM080L	C11F4TM080L
TM100D	C11F3TM100L	C11F6TM100L	C11F4TM100L
TM125D	C12F3TM125L	C12F6TM125L	C12F4TM125L
TM160D	C12F3TM160L	C12F6TM160L	C12F4TM160L

DB438974.ai

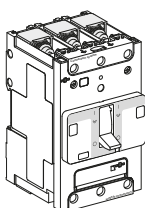

Compression lug/busbar connectors

Rating	3P	4P 3d	4P 4d
TM16D	C11F3TM016B	C11F6TM016B	C11F4TM016B
TM25D	C11F3TM025B	C11F6TM025B	C11F4TM025B
TM32D	C11F3TM032B	C11F6TM032B	C11F4TM032B
TM40D	C11F3TM040B	C11F6TM040B	C11F4TM040B
TM50D	C11F3TM050B	C11F6TM050B	C11F4TM050B
TM63D	C11F3TM063B	C11F6TM063B	C11F4TM063B
TM80D	C11F3TM080B	C11F6TM080B	C11F4TM080B
TM100D	C11F3TM100B	C11F6TM100B	C11F4TM100B
TM125D	C12F3TM125B	C12F6TM125B	C12F4TM125B
TM160D	C12F3TM160B	C12F6TM160B	C12F4TM160B

ComPacT NSXm N (50 KA at 380/415 V)

With thermal-magnetic trip unit TM-D

DB438973.ai

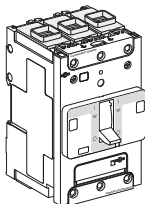

EverLink™ connectors

Rating	3P	4P 3d	4P 4d
TM16D	C11N3TM016L	C11N6TM016L	C11N4TM016L
TM25D	C11N3TM025L	C11N6TM025L	C11N4TM025L
TM32D	C11N3TM032L	C11N6TM032L	C11N4TM032L
TM40D	C11N3TM040L	C11N6TM040L	C11N4TM040L
TM50D	C11N3TM050L	C11N6TM050L	C11N4TM050L
TM63D	C11N3TM063L	C11N6TM063L	C11N4TM063L
TM80D	C11N3TM080L	C11N6TM080L	C11N4TM080L
TM100D	C11N3TM100L	C11N6TM100L	C11N4TM100L
TM125D	C12N3TM125L	C12N6TM125L	C12N4TM125L
TM160D	C12N3TM160L	C12N6TM160L	C12N4TM160L

DB438974.ai

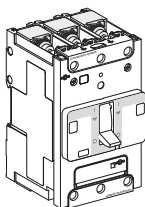

Compression lug/busbar connectors

Rating	3P	4P 3d	4P 4d
TM16D	C11N3TM016B	C11N6TM016B	C11N4TM016B
TM25D	C11N3TM025B	C11N6TM025B	C11N4TM025B
TM32D	C11N3TM032B	C11N6TM032B	C11N4TM032B
TM40D	C11N3TM040B	C11N6TM040B	C11N4TM040B
TM50D	C11N3TM050B	C11N6TM050B	C11N4TM050B
TM63D	C11N3TM063B	C11N6TM063B	C11N4TM063B
TM80D	C11N3TM080B	C11N6TM080B	C11N4TM080B
TM100D	C11N3TM100B	C11N6TM100B	C11N4TM100B
TM125D	C12N3TM125B	C12N6TM125B	C12N4TM125B
TM160D	C12N3TM160B	C12N6TM160B	C12N4TM160B

F

Complete Fixed Device

ComPacT NSXm H (70 KA at 380/415 V)

ComPacT NSXm H (70 KA at 380/415 V)

With thermal-magnetic trip unit TM-D

DB438973.ai

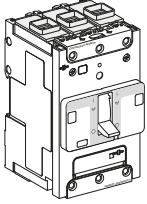

EverLink™ connectors

Rating	3P	4P 3d	4P 4d
TM16D	C11H3TM016L	C11H6TM016L	C11H4TM016L
TM25D	C11H3TM025L	C11H6TM025L	C11H4TM025L
TM32D	C11H3TM032L	C11H6TM032L	C11H4TM032L
TM40D	C11H3TM040L	C11H6TM040L	C11H4TM040L
TM50D	C11H3TM050L	C11H6TM050L	C11H4TM050L
TM63D	C11H3TM063L	C11H6TM063L	C11H4TM063L
TM80D	C11H3TM080L	C11H6TM080L	C11H4TM080L
TM100D	C11H3TM100L	C11H6TM100L	C11H4TM100L
TM125D	C12H3TM125L	C12H6TM125L	C12H4TM125L
TM160D	C12H3TM160L	C12H6TM160L	C12H4TM160L

DB438974.ai

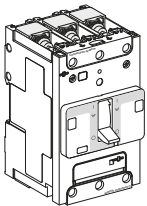

Compression lug/busbar connectors

Rating	3P	4P 3d	4P 4d
TM16D	C11H3TM016B	C11H6TM016B	C11H4TM016B
TM25D	C11H3TM025B	C11H6TM025B	C11H4TM025B
TM32D	C11H3TM032B	C11H6TM032B	C11H4TM032B
TM40D	C11H3TM040B	C11H6TM040B	C11H4TM040B
TM50D	C11H3TM050B	C11H6TM050B	C11H4TM050B
TM63D	C11H3TM063B	C11H6TM063B	C11H4TM063B
TM80D	C11H3TM080B	C11H6TM080B	C11H4TM080B
TM100D	C11H3TM100B	C11H6TM100B	C11H4TM100B
TM125D	C12H3TM125B	C12H6TM125B	C12H4TM125B
TM160D	C12H3TM160B	C12H6TM160B	C12H4TM160B

Complete Fixed Device

ComPacT NSXm MicroLogic Vigi 4.1 E/B/F

(16/25/36 KA at 380/415 V)

ComPacT NSXm MicroLogic Vigi 4.1 E (16 KA at 380/415 V)

With MicroLogic Vigi 4.1

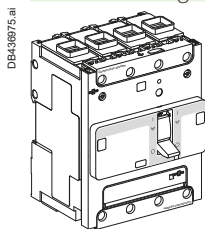

EverLink™ connectors

Rating	3P	4P
25 A	C11E34V025L	C11E44V025L
50 A	C11E34V050L	C11E44V050L
100 A	C11E34V100L	C11E44V100L
160 A	C12E34V160L	C12E44V160L

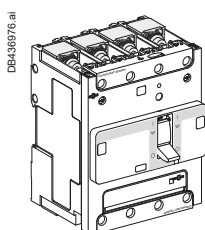

Compression lug/busbar connectors

Rating	3P	4P
25 A	C11E34V025B	C11E44V025B
50 A	C11E34V050B	C11E44V050B
100 A	C11E34V100B	C11E44V100B
160 A	C12E34V160B	C12E44V160B

ComPacT NSXm MicroLogic Vigi 4.1 B (25 KA at 380/415 V)

With MicroLogic Vigi 4.1

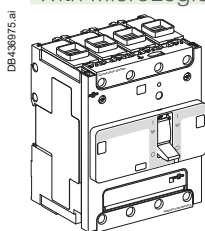

EverLink™ connectors

Rating	3P	4P
25 A	C11B34V025L	C11B44V025L
50 A	C11B34V050L	C11B44V050L
100 A	C11B34V100L	C11B44V100L
160 A	C12B34V160L	C12B44V160L

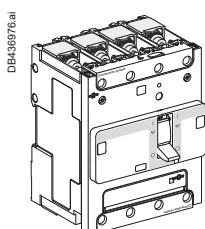

Compression lug/busbar connectors

Rating	3P	4P
25 A	C11B34V025B	C11B44V025B
50 A	C11B34V050B	C11B44V050B
100 A	C11B34V100B	C11B44V100B
160 A	C12B34V160B	C12B44V160B

ComPacT NSXm MicroLogic Vigi 4.1 F (36 KA at 380/415 V)

With MicroLogic Vigi 4.1

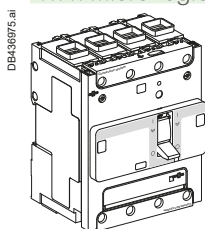

EverLink™ connectors

Rating	3P	4P
25 A	C11F34V025L	C11F44V025L
50 A	C11F34V050L	C11F44V050L
100 A	C11F34V100L	C11F44V100L
160 A	C12F34V160L	C12F44V160L

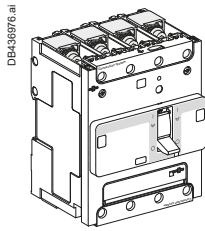

Compression lug/busbar connectors

Rating	3P	4P
25 A	C11F34V025B	C11F44V025B
50 A	C11F34V050B	C11F44V050B
100 A	C11F34V100B	C11F44V100B
160 A	C12F34V160B	C12F44V160B



Complete Fixed Device

ComPacT NSXm MicroLogic Vigi 4.1 N/H (50/70 KA at 380/415 V)

ComPacT NSXm MicroLogic Vigi 4.1 N (50 KA at 380/415 V)

With MicroLogic Vigi 4.1

DB43875.ai

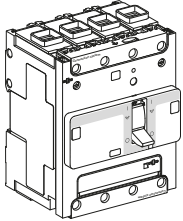

EverLink™ connectors

Rating	3P	4P
25 A	C11N34V025L	C11N44V025L
50 A	C11N34V050L	C11N44V050L
100 A	C11N34V100L	C11N44V100L
160 A	C12N34V160L	C12N44V160L

DB43876.ai

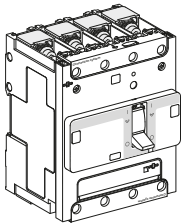

Compression lug/busbar connectors

Rating	3P	4P
25 A	C11N34V025B	C11N44V025B
50 A	C11N34V050B	C11N44V050B
100 A	C11N34V100B	C11N44V100B
160 A	C12N34V160B	C12N44V160B

ComPacT NSXm MicroLogic Vigi 4.1 H (70 KA at 380/415 V)

With MicroLogic Vigi 4.1

DB43875.ai

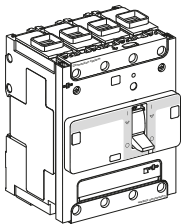

EverLink™ connectors

Rating	3P	4P
25 A	C11H34V025L	C11H44V025L
50 A	C11H34V050L	C11H44V050L
100 A	C11H34V100L	C11H44V100L
160 A	C12H34V160L	C12H44V160L

DB43876.ai

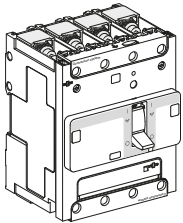

Compression lug/busbar connectors

Rating	3P	4P
25 A	C11H34V025B	C11H44V025B
50 A	C11H34V050B	C11H44V050B
100 A	C11H34V100B	C11H44V100B
160 A	C12H34V160B	C12H44V160B

F

ComPacT NSXm NA Switch-Disconnecter

DB438973.ai

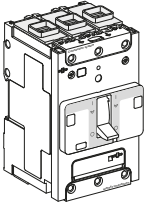

EverLink™ connectors		
Rating	3P	4P
50NA	C113050LS	C114050LS
100NA	C113100LS	C114100LS
160NA	C123160LS	C124160LS

DB438974.ai

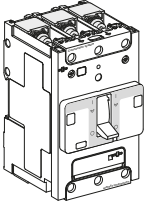

Compression lug/busbar connectors		
Rating	3P	4P
50NA	C113050BS	C114050BS
100NA	C113100BS	C114100BS
160NA	C123160BS	C124160BS

Accessories

Connection and Insulation

Connection Accessories (Cu or Al)

Bare cable connectors

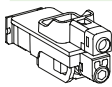
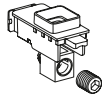
 DB421533.eps	Everlink connector with control wire terminal	1x (2.5 to 95 mm ²); ≤ 160 A Cu or ≤ 100 A Al	Set of 3	LV426970
			Set of 4	LV426971
 DB418793.eps	Aluminium connector	1x (2.5 to 70 mm ²); ≤ 125 A Cu or Al	Set of 2	LV426966
			Set of 3	LV426967

Compression lugs/busbar connectors

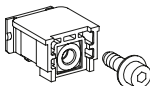
 DB421537.eps	Terminal with nuts and screws M6	≤ 160 A	Set of 3	LV426960
			Set of 4	LV426961

Terminal extensions

 DB421538.eps	Spreaders from 27 to 35 mm pitch ^[1]	3P	LV426940
		4P	LV426941

Crimp lugs for copper cable ^[1]

 DB421538.eps	For cable 50 mm ²	Set of 3	LV426978
		Set of 4	LV426979
	For cable 70 mm ²	Set of 3	LV426980
		Set of 4	LV426981
	For cable 95 mm ²	Set of 3	LV426982
		Set of 4	LV426983

Crimp lugs for aluminium cable ^[1]

 DB421540.eps	For cable 95 mm ² rigid	Set of 3	LV426984
		Set of 4	LV426985
	For cable 120 mm ² rigid	Set of 3	LV426976
		Set of 4	LV426977

Torque limiting breakaway bits

 DB421541.eps	9 N.m	Set of 6	LV426990
		Set of 8	LV426991
	5 N.m	Set of 6	LV426992
		Set of 8	LV426993

Insulation Accessories

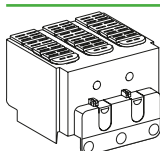
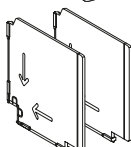
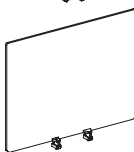
 DB421542.eps	1 long terminal shield	3P	LV426912
		4P	LV426913
 DB421543.eps	Interphase barriers	Set of 6	LV426920
 DB421544.eps	2 rear insulation screens	3P	LV426922
		4P	LV426923

[1] Supplied with 2 or 3 interphase barriers.

F

Electrical Auxiliaries

Auxiliary contacts (screwless, screw)



Standard OF or SD screwless type	LV426950
----------------------------------	----------

Wireless indication auxiliary



Wireless OF or SD	LV429453
-------------------	----------

SDx for MicroLogic Vigi 4.1

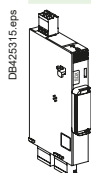

SDx module 24-250 V AC/DC	LV426900
---------------------------	----------

Voltage releases



Standard	Voltage	MX	MN		
AC	24 V 50/60 Hz	LV426841	LV426801		
	48 V 50/60 Hz	LV426842	LV426802		
	110...130 V 50/60 Hz	LV426843	LV426803		
	220...240 V 50 Hz	LV426844	LV426804		
	208...240 V 60 Hz				
	277 V 60 Hz	LV426844	LV426805		
	380...415 V 50 Hz	LV426846	LV426806		
DC	440...480 V 60 Hz	LV426846	LV426807		
	12 V DC	LV426850	-		
	24 V DC	LV426841	LV426801		
	48 V DC	LV426842	LV426802		
	125 V DC	LV426843	LV426803		
	250 V DC	LV426844	LV426815		
	Pre-wired ^[1]	Voltage	MX	MN	
AC			24 V 50/60 Hz	LV426861	LV426821
			48 V 50/60 Hz	LV426862	LV426822
			110...130 V 50/60 Hz	LV426863	LV426823
			220...240 V 50 Hz	LV426864	LV426824
			208...240 V 60 Hz		
			277 V 60 Hz	LV426864	LV426825
		380...415 V 50 Hz	LV426866	LV426826	
DC		440...480 V 60 Hz	LV426866	LV426827	
		12 V DC	LV426870	-	
		24 V DC	LV426861	LV426821	
		48 V DC	LV426862	LV426822	
		125 V DC	LV426863	LV426823	
		250 V DC	LV426864	LV426835	



Time delay unit for undervoltage release (MN)

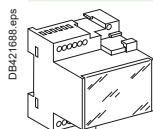

MN 48 V 50/60 Hz with fixed time delay		
Composed of:	MN 48 V DC	LV426802
	Delay unit 48 V 50/60 Hz	LV429426
MN 220-240 V 50/60 Hz with fixed time delay		
Composed of:	MN 250 V DC	LV426815
	Delay unit 220-240 V 50/60 Hz	LV429427
MN 48 V DC/AC 50/60 Hz with adjustable time delay		
Composed of:	MN 48 V DC	LV426802
	Delay unit 48 V DC/AC 50/60 Hz	33680
MN 110-130 V DC/AC 50/60 Hz with adjustable time delay		
Composed of:	MN 125 V DC	LV426803
	Delay unit 100-130 V DC/AC 50/60 Hz	33681
MN 220-250 V DC/AC 50/60 Hz with adjustable time delay		
Composed of:	MN 250 V DC	LV426815
	Delay unit 200-250 V DC/AC 50-60 Hz	33682

[1] Cable: 1 meter long - AWG 18 - 480 V UL certified.



Accessories

Rotary Handles, Locks, Seals, Indication and Measurements

Rotary Handle

Direct rotary handle

DB439299.ai		With black handle	LV426930T
		With red handle on yellow front	LV426931T

Extended rotary handle

DB439393.ai		With black handle IP54	LV426932T
		With red handle on yellow front IP54	LV426933T
		With red handle on yellow front IP65	LV426934T

DB421689.eps		Open door shaft operator	LV426937
--------------	---	--------------------------	----------

DB421877.eps		Laser tool	GVAPL01
--------------	---	------------	---------

Side rotary handle

DB439301.ai		With black handle IP54	LV426935T
		With red handle on yellow front IP54	LV426936T

Universal handle

DB439360.ai		Black handle IP54 (spare part for replacement of front, ext. or side rotary handle)	LV426997T
		Red handle on yellow front IP54	LV426998T
		Red handle on yellow front IP65	LV426999T

Locks

Toggle locking device for 1 to 3 padlocks

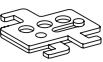
DB425851.eps		By removable device	29370
--------------	---	---------------------	-------

DB421555.eps		By fixed device (OFF or ON)	LV426905
--------------	---	-----------------------------	----------

DB421690.eps		By fixed device (OFF only)	LV426906
--------------	---	----------------------------	----------

Lead - Sealing Accessories

DB421556.eps		Bag of accessories	LV429375
--------------	---	--------------------	----------

Indication and Measurement Modules

PowerLogic PowerTag Energy Flex NSXm

DB438110.ai		Rating (A)	160 A
		3P/3P+N	A9MEM1580

Spare Parts

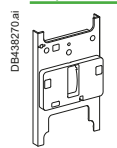
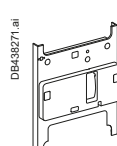
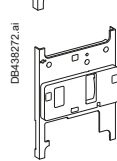
 <p>DB438270.ai</p>	<p>Front cover</p>	<p>3P</p>	<p>LV426946</p>
 <p>DB438271.ai</p>		<p>4P</p>	<p>LV426947</p>
 <p>DB438272.ai</p>		<p>ELCB ^[1]</p>	<p>LV426948</p>

Test Tool, Software, Demo

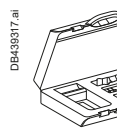
<p>Test tool</p>			
 <p>DB111449.eps</p>	<p>Pocket battery for MicroLogic</p>		<p>LV434206</p>
<p>Service Interface Test Kit</p>			
 <p>DB438317.ai</p>	<p>BTM (Breaker Test Module) Service interface spare part Service interface AC/DC power Service interface 7 pin cable ACB MCCB TU Service interface ULP cable Service interface USB magnet cable</p>		<p>LV485500 LV485510SP LV485511SP LV485512SP LV485514SP LV485517SP</p>

[1] ELCB: Earth Leakage Circuit Breaker.



F

Catalog Numbers: ComPacT NSX100-250

Complete Fixed Device

ComPacT NSX100/160 1P-2P NSX250N 1P	F-16
ComPacT NSX100/160/250B (25 KA 380/415 V)	F-17
ComPacT NSX100/160/250F (36 KA 380/415 V)	F-18
ComPacT NSX100/160/250N (50 KA 380/415 V)	F-20
ComPacT NSX100/160/250H (70 KA 380/415 V)	F-22
ComPacT NSX100/250R (200 KA 380/415 V - 45 KA 690 V)	F-24
ComPacT NSX100/250HB1 (85 KA 500 V - 75 KA 690 V)	F-26
ComPacT NSX100/250HB2 (100 KA 500 V - 100 KA 690 V)	F-28
ComPacT NSX100/160/250NA	F-30

Based on Separate Components

ComPacT NSX100/160/250	F-31
------------------------------	------

Trip Unit Accessories

ComPacT NSX100/160/250	F-34
------------------------------	------

Installation and Connection

ComPacT NSX100/160/250	F-35
------------------------------	------

Accessories and Auxiliaries

ComPacT NSX100/160/250	F-36
------------------------------	------

Other Chapters

Select Circuit Breakers and Switch-Disconnectors	A-1
Select Protection	B-1
Customize Circuit Breakers with Accessories	C-1
Smart Panel Integration	D-1
Switchboard Integration	E-1
Glossary	G-1
Additional Characteristics	H-1

Complete Fixed Device

ComPacT NSX100/160 1P-2P NSX250N 1P

ComPacT NSX100/160 F/N/M/S 1P/2P

With thermal-magnetic trip unit TM-D

DB438977.ai

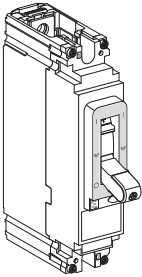

ComPacT NSX100F AC/DC		ComPacT NSX100F AC/DC
Rating	1P 1d (Icu = 18 kA 220/240 V AC)	2P 2d (Icu = 18 kA 380/415 V AC)
TM16D	C10F1TM016	C10F2TM016
TM20D	C10F1TM020	C10F2TM020
TM25D	C10F1TM025	C10F2TM025
TM30D	C10F1TM030	C10F2TM030
TM40D	C10F1TM040	C10F2TM040
TM50D	C10F1TM050	C10F2TM050
TM63D	C10F1TM063	C10F2TM063
TM80D	C10F1TM080	C10F2TM080
TM100D	C10F1TM100	C10F2TM100

ComPacT NSX160F AC/DC		ComPacT NSX160F AC/DC
Rating	1P 1d (Icu = 18 kA 220/240 V AC)	2P 2d (Icu = 18 kA 380/415 V AC)
TM125D	C16F1TM125	C16F2TM125
TM160D	C16F1TM160	C16F2TM160

DB436978.ai

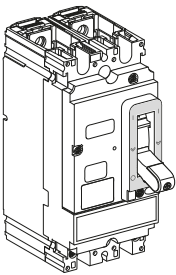

ComPacT NSX100N AC/DC		ComPacT NSX100M AC/DC
Rating	1P 1d (Icu = 25 kA 220/240 V AC)	2P 2d (Icu = 25 kA 380/415 V AC)
TM16D	C10N1TM016	C10M2TM016
TM20D	C10N1TM020	C10M2TM020
TM25D	C10N1TM025	C10M2TM025
TM30D	C10N1TM030	C10M2TM030
TM40D	C10N1TM040	C10M2TM040
TM50D	C10N1TM050	C10M2TM050
TM63D	C10N1TM063	C10M2TM063
TM80D	C10N1TM080	C10M2TM080
TM100D	C10N1TM100	C10M2TM100

ComPacT NSX160N AC/DC		ComPacT NSX160M AC/DC
Rating	1P 1d (Icu = 25 kA 220/240 V AC)	2P 2d (Icu = 50 kA 380/415 V AC)
TM125D	C16N1TM125	C16M2TM125
TM160D	C16N1TM160	C16M2TM160

ComPacT NSX100M AC/DC		ComPacT NSX100S AC/DC
Rating	1P 1d (Icu = 40 kA 220/240 V AC)	2P 2d (Icu = 70 kA 380/415 V AC)
TM16D	C10M1TM016	C10S2TM016
TM20D	C10M1TM020	C10S2TM020
TM25D	C10M1TM025	C10S2TM025
TM30D	C10M1TM030	C10S2TM030
TM40D	C10M1TM040	C10S2TM040
TM50D	C10M1TM050	C10S2TM050
TM63D	C10M1TM063	C10S2TM063
TM80D	C10M1TM080	C10S2TM080
TM100D	C10M1TM100	C10S2TM100

ComPacT NSX160M AC/DC		ComPacT NSX160S AC/DC
Rating	1P 1d (Icu = 40 kA 220/240 V AC)	2P 2d (Icu = 70 kA 380/415 V AC)
TM125D	C16M1TM125	C16S2TM125
TM160D	C16M1TM160	C16S2TM160

ComPacT NSX250 N 1P

With thermal-magnetic trip unit TM-D

ComPacT NSX250N AC	
Rating	1P 1d (Icu = 25 kA 220/240 V AC)
TM200D	C25N1TM200
TM250D	C25N1TM250

F

Complete Fixed Device

ComPacT NSX100/160/250B (25 KA 380/415 V)

ComPacT NSX100/160/250B

With thermal-magnetic trip unit TM-D

DB-438166.ai

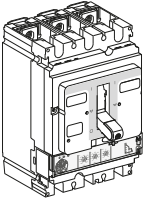

ComPacT NSX100B (25 kA at 380/415 V)			
Rating	3P 3d	4P 3d	4P 4d
TM16D	C10B3TM016	C10B6TM016	C10B4TM016
TM25D	C10B3TM025	C10B6TM025	C10B4TM025
TM32D	C10B3TM032	C10B6TM032	C10B4TM032
TM40D	C10B3TM040	C10B6TM040	C10B4TM040
TM50D	C10B3TM050	C10B6TM050	C10B4TM050
TM63D	C10B3TM063	C10B6TM063	C10B4TM063
TM80D	C10B3TM080	C10B6TM080	C10B4TM080
TM100D	C10B3TM100	C10B6TM100	C10B4TM100
ComPacT NSX160B (25 kA at 380/415 V)			
Rating	3P 3d	4P 3d	4P 4d
TM80D	C16B3TM080	C16B6TM080	C16B4TM080
TM100D	C16B3TM100	C16B6TM100	C16B4TM100
TM125D	C16B3TM125	C16B6TM125	C16B4TM125
TM160D	C16B3TM160	C16B6TM160	C16B4TM160
ComPacT NSX250B (25 kA at 380/415 V)			
Rating	3P 3d	4P 3d	4P 4d
TM125D	C25B3TM125	C25B6TM125	C25B4TM125
TM160D	C25B3TM160	C25B6TM160	C25B4TM160
TM200D	C25B3TM200	C25B6TM200	C25B4TM200
TM250D	C25B3TM250	C25B6TM250	C25B4TM250

With electronic trip unit MicroLogic 2.2 (LS_oI protection)

DB-438167.ai

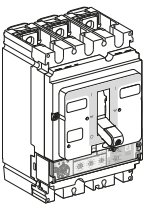

ComPacT NSX100B (25 kA at 380/415 V)		
Rating	3P 3d	4P 3d, 4d, 3d + N/2
40	C10B32D040	C10B42D040
100	C10B32D100	C10B42D100
ComPacT NSX160B (25 kA at 380/415 V)		
Rating	3P 3d	4P 3d, 4d, 3d + N/2
100	C16B32D100	C16B42D100
160	C16B32D160	C16B42D160
ComPacT NSX250B (25 kA at 380/415 V)		
Rating	3P 3d	4P 3d, 4d, 3d + N/2
100	C25B32D100	C25B42D100
160	C25B32D160	C25B42D160
250	C25B32D250	C25B42D250

With electronic trip unit MicroLogic Vigi 4.2 (LS_oIR protection)

DB-438168.ai

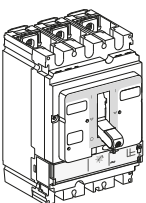

ComPacT NSX100B (25 kA 380/415V)		
Rating	3P 3d	4P 4d, 3d + N/2
40 A	C10B34V040	C10B44V040
100 A	C10B34V100	C10B44V100
ComPacT NSX160B (25 kA 380/415V)		
Rating	3P 3d	4P 4d, 3d + N/2
100 A	C16B34V100	C16B44V100
160 A	C16B34V160	C16B44V160
ComPacT NSX250B (25 kA 380/415V)		
Rating	3P 3d	4P 4d, 3d + N/2
100 A	C25B34V100	C25B44V100
160 A	C25B34V160	C25B44V160
250 A	C25B34V250	C25B44V250

With electronic trip unit MicroLogic Vigi 7.2 E (LSIR protection)

DB-438567.ai

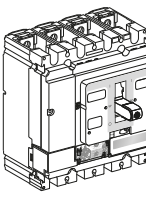

ComPacT NSX100B (25 kA 380/415V)		
Rating	3P 3d	4P 3d, 4d, 3d + N/2
40 A	-	C10B47E040
100 A	-	C10B47E100
ComPacT NSX160B (25 kA 380/415V)		
Rating	3P 3d	4P 3d, 4d, 3d + N/2
100 A	-	C16B47E100
160 A	-	C16B47E160
ComPacT NSX250B (25 kA 380/415V)		
Rating	3P 3d	4P 3d, 4d, 3d + N/2
100 A	-	C25B47E100
160 A	-	C25B47E160
250 A	-	C25B47E250



Complete Fixed Device

ComPacT NSX100/160/250F (36 kA 380/415 V)

ComPacT NSX100/160/250F

With thermal-magnetic trip unit TM-D

DB438165.ai

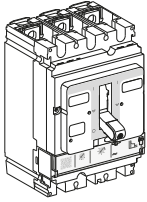

ComPacT NSX100F (36 kA at 380/415 V)

Rating	3P 3d	4P 3d	4P 4d
TM16D	C10F3TM016	C10F6TM016	C10F4TM016
TM25D	C10F3TM025	C10F6TM025	C10F4TM025
TM32D	C10F3TM032	C10F6TM032	C10F4TM032
TM40D	C10F3TM040	C10F6TM040	C10F4TM040
TM50D	C10F3TM050	C10F6TM050	C10F4TM050
TM63D	C10F3TM063	C10F6TM063	C10F4TM063
TM80D	C10F3TM080	C10F6TM080	C10F4TM080
TM100D	C10F3TM100	C10F6TM100	C10F4TM100

ComPacT NSX160F (36 kA at 380/415 V)

Rating	3P 3d	4P 3d	4P 4d
TM80D	C16F3TM080	C16F6TM080	C16F4TM080
TM100D	C16F3TM100	C16F6TM100	C16F4TM100
TM125D	C16F3TM125	C16F6TM125	C16F4TM125
TM160D	C16F3TM160	C16F6TM160	C16F4TM160

ComPacT NSX250F (36 kA at 380/415 V)

Rating	3P 3d	4P 3d	4P 4d
TM125D	C25F3TM125	C25F6TM125	C25F4TM125
TM160D	C25F3TM160	C25F6TM160	C25F4TM160
TM200D	C25F3TM200	C25F6TM200	C25F4TM200
TM250D	C25F3TM250	C25F6TM250	C25F4TM250

With electronic trip unit MicroLogic 2.2 (LS_oI protection)

DB438166.ai

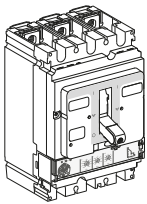

ComPacT NSX100F (36 kA at 380/415 V)

Rating	3P 3d	4P 3d, 4d, 3d + N/2
40	C10F32D040	C10F42D040
100	C10F32D100	C10F42D100

ComPacT NSX160F (36 kA at 380/415 V)

Rating	3P 3d	4P 3d, 4d, 3d + N/2
100	C16F32D100	C16F42D100
160	C16F32D160	C16F42D160

ComPacT NSX250F (36 kA at 380/415 V)

Rating	3P 3d	4P 3d, 4d, 3d + N/2
100	C25F32D100	C25F42D100
160	C25F32D160	C25F42D160
250	C25F32D250	C25F42D250

With electronic trip unit MicroLogic Vigi 4.2 (LS_oIR protection)

DB438167.ai

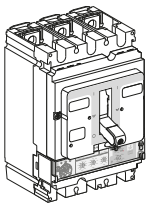

ComPacT NSX100F (36 kA 380/415V)

Rating	3P 3d	4P 4d, 3d + N/2
40 A	C10F34V040	C10F44V040
100 A	C10F34V100	C10F44V100

ComPacT NSX160F (36 kA 380/415V)

Rating	3P 3d	4P 4d, 3d + N/2
100 A	C16F34V100	C16F44V100
160 A	C16F34V160	C16F44V160

ComPacT NSX250F (36 kA 380/415V)

Rating	3P 3d	4P 4d, 3d + N/2
100 A	C25F34V100	C25F44V100
160 A	C25F34V160	C25F44V160
250 A	C25F34V250	C25F44V250

With electronic trip unit MicroLogic Vigi 7.2 E (LSIR protection + embedded energy management)

DB438657.ai

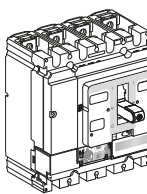

ComPacT NSX100F (36 kA 380/415V)

Rating	3P 3d	4P 4d, 3d + N/2
40 A	-	C10F47E040
100 A	-	C10F47E100

ComPacT NSX160F (36 kA 380/415V)

Rating	3P 3d	4P 4d, 3d + N/2
100 A	-	C16F47E100
160 A	-	C16F47E160

ComPacT NSX250F (36 kA 380/415V)

Rating	3P 3d	4P 4d, 3d + N/2
100 A	-	C25F47E100
160 A	-	C25F47E160
250 A	-	C25F47E250

Complete Fixed Device

ComPacT NSX100/160/250F (36 kA 380/415 V)

ComPacT NSX100/160/250F

With magnetic trip unit MA

DE-439168.ai

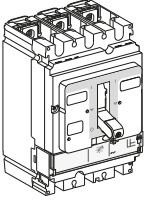

ComPacT NSX100F (36 kA at 380/415 V)

Rating	3P 3d
MA2.5	C10F3MA003
MA6.3	C10F3MA007
MA12.5	C10F3MA013
MA25	C10F3MA025
MA50	C10F3MA050
MA100	C10F3MA100

ComPacT NSX160F (36 kA at 380/415 V)

Rating	3P 3d
MA100	C16F3MA100
MA150	C16F3MA150

ComPacT NSX250F (36 kA at 380/415 V)

Rating	3P 3d
MA150	C25F3MA150
MA220	C25F3MA220



Complete Fixed Device

ComPacT NSX100/160/250N (50 KA 380/415 V)

ComPacT NSX100/160/250N

With thermal-magnetic trip unit TM-D

DB438165.ai

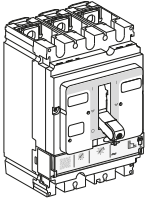

ComPacT NSX100N (50 kA at 380/415 V)			
Rating	3P 3d	4P 3d	4P 4d
TM16D	C10N3TM016	C10N6TM016	C10N4TM016
TM25D	C10N3TM025	C10N6TM025	C10N4TM025
TM32D	C10N3TM032	C10N6TM032	C10N4TM032
TM40D	C10N3TM040	C10N6TM040	C10N4TM040
TM50D	C10N3TM050	C10N6TM050	C10N4TM050
TM63D	C10N3TM063	C10N6TM063	C10N4TM063
TM80D	C10N3TM080	C10N6TM080	C10N4TM080
TM100D	C10N3TM100	C10N6TM100	C10N4TM100
ComPacT NSX160N (50 kA at 380/415 V)			
Rating	3P 3d	4P 3d	4P 4d
TM80D	C16N3TM080	C16N6TM080	C16N4TM080
TM100D	C16N3TM100	C16N6TM100	C16N4TM100
TM125D	C16N3TM125	C16N6TM125	C16N4TM125
TM160D	C16N3TM160	C16N6TM160	C16N4TM160
ComPacT NSX250N (50 kA at 380/415 V)			
Rating	3P 3d	4P 3d	4P 4d
TM125D	C25N3TM125	C25N6TM125	C25N4TM125
TM160D	C25N3TM160	C25N6TM160	C25N4TM160
TM200D	C25N3TM200	C25N6TM200	C25N4TM200
TM250D	C25N3TM250	C25N6TM250	C25N4TM250

With electronic trip unit MicroLogic 2.2 (LS_oI protection)

DB438166.ai

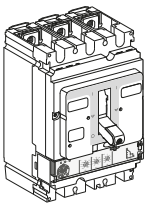

ComPacT NSX100N (50 kA at 380/415 V)			
Rating	3P 3d	4P 3d	4P 3d, 4d, 3d + N/2
40 A	C10N32D040		C10N42D040
100 A	C10N32D100		C10N42D100
ComPacT NSX160N (50 kA at 380/415 V)			
Rating	3P 3d	4P 3d	4P 3d, 4d, 3d + N/2
100 A	C16N32D100		C16N42D100
160 A	C16N32D160		C16N42D160
ComPacT NSX250N (50 kA at 380/415 V)			
Rating	3P 3d	4P 3d	4P 3d, 4d, 3d + N/2
100 A	C25N32D100		C25N42D100
160 A	C25N32D160		C25N42D160
250 A	C25N32D250		C25N42D250

With electronic trip unit MicroLogic Vigi 4.2 (LS_oIR protection)

DB438167.ai

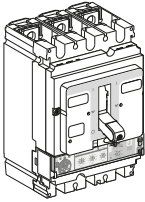

ComPacT NSX100N (50 kA 380/415V)			
Rating	3P 3d	4P 3d	4P 4d, 3d + N/2
40 A	C10N34V040		C10N44V040
100 A	C10N34V100		C10N44V100
ComPacT NSX160N (50 kA 380/415V)			
Rating	3P 3d	4P 3d	4P 4d, 3d + N/2
100 A	C16N34V100		C16N44V100
160 A	C16N34V160		C16N44V160
ComPacT NSX250N (50 kA 380/415V)			
Rating	3P 3d	4P 3d	4P 4d, 3d + N/2
100 A	C25N34V100		C25N44V100
160 A	C25N34V160		C25N44V160
250 A	C25N34V250		C25N44V250

With electronic trip unit MicroLogic Vigi 7.2 E (LSIR protection + embedded energy management)

DB43867.ai

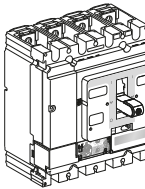

ComPacT NSX100N (50 kA 380/415V)			
Rating	3P 3d	4P 3d	4P 4d, 3d + N/2
40 A	-		C10N47E040
100 A	-		C10N47E100
ComPacT NSX160N (50 kA 380/415V)			
Rating	3P 3d	4P 3d	4P 4d, 3d + N/2
100 A	-		C16N47E100
160 A	-		C16N47E160
ComPacT NSX250N (50 kA 380/415V)			
Rating	3P 3d	4P 3d	4P 4d, 3d + N/2
100 A	-		C25N47E100
160 A	-		C25N47E160
250 A	-		C25N47E250

Complete Fixed Device

ComPacT NSX100/160/250N (50 KA 380/415 V)

ComPacT NSX100/160/250N

With magnetic trip unit MA

DB458108.ai

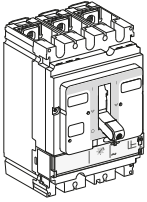

ComPacT NSX100N (50 kA at 380/415 V)

Rating	3P 3d
MA2.5	C10N3MA003
MA6.3	C10N3MA007
MA12.5	C10N3MA013
MA25	C10N3MA025
MA50	C10N3MA050
MA100	C10N3MA100

ComPacT NSX160N (50 kA at 380/415 V)

Rating	3P 3d
MA100	C16N3MA100
MA150	C16N3MA150

ComPacT NSX250N (50 kA at 380/415 V)

Rating	3P 3d
MA150	C25N3MA150
MA220	C25N3MA220



Complete Fixed Device

ComPacT NSX100/160/250H (70 KA 380/415 V)

ComPacT NSX100/160/250H

With thermal-magnetic trip unit TM-D

DB438165.ai

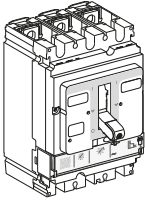

ComPacT NSX100H (70 kA at 380/415 V)

Rating	3P 3d	4P 3d	4P 4d
TM16D	C10H3TM016	C10H6TM016	C10H4TM016
TM25D	C10H3TM025	C10H6TM025	C10H4TM025
TM32D	C10H3TM032	C10H6TM032	C10H4TM032
TM40D	C10H3TM040	C10H6TM040	C10H4TM040
TM50D	C10H3TM050	C10H6TM050	C10H4TM050
TM63D	C10H3TM063	C10H6TM063	C10H4TM063
TM80D	C10H3TM080	C10H6TM080	C10H4TM080
TM100D	C10H3TM100	C10H6TM100	C10H4TM100

ComPacT NSX160H (70 kA at 380/415 V)

Rating	3P 3d	4P 3d	4P 4d
TM80D	C16H3TM080	C16H6TM080	C16H4TM080
TM100D	C16H3TM100	C16H6TM100	C16H4TM100
TM125D	C16H3TM125	C16H6TM125	C16H4TM125
TM160D	C16H3TM160	C16H6TM160	C16H4TM160

ComPacT NSX250H (70 kA at 380/415 V)

Rating	3P 3d	4P 3d	4P 4d
TM125D	C25H3TM125	C25H6TM125	C25H4TM125
TM160D	C25H3TM160	C25H6TM160	C25H4TM160
TM200D	C25H3TM200	C25H6TM200	C25H4TM200
TM250D	C25H3TM250	C25H6TM250	C25H4TM250

With electronic trip unit MicroLogic 2.2 (LS_oI protection)

DB438166.ai

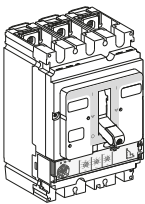

ComPacT NSX100H (70 kA at 380/415 V)

Rating	3P 3d	4P 3d, 4d, 3d + N/2
40 A	C10H32D040	C10H42D040
100 A	C10H32D100	C10H42D100

ComPacT NSX160H (70 kA at 380/415 V)

Rating	3P 3d	4P 3d, 4d, 3d + N/2
100 A	C16H32D100	C16H42D100
160 A	C16H32D160	C16H42D160

ComPacT NSX250H (70 kA at 380/415 V)

Rating	3P 3d	4P 3d, 4d, 3d + N/2
100 A	C25H32D100	C25H42D100
160 A	C25H32D160	C25H42D160
250 A	C25H32D250	C25H42D250

With electronic trip unit MicroLogic Vigi 4.2 (LS_oIR protection)

DB438167.ai

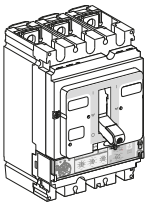

ComPacT NSX100H (70 kA 380/415V)

Rating	3P 3d	4P 4d, 3d + N/2
40 A	C10H34V040	C10H44V040
100 A	C10H34V100	C10H44V100

ComPacT NSX160H (70 kA 380/415V)

Rating	3P 3d	4P 4d, 3d + N/2
100 A	C16H34V100	C16H44V100
160 A	C16H34V160	C16H44V160

ComPacT NSX250H (70 kA 380/415V)

Rating	3P 3d	4P 4d, 3d + N/2
100 A	C25H34V100	C25H44V100
160 A	C25H34V160	C25H44V160
250 A	C25H34V250	C25H44V250

With electronic trip unit MicroLogic Vigi 7.2 E (LSIR protection + embedded energy management)

DB438567.ai

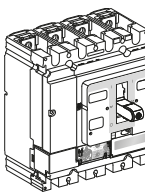

ComPacT NSX100H (70 kA 380/415V)

Rating	3P 3d	4P 4d, 3d + N/2
40 A	-	C10H47E040
100 A	-	C10H47E100

ComPacT NSX160H (70 kA 380/415V)

Rating	3P 3d	4P 4d, 3d + N/2
100 A	-	C16H47E100
160 A	-	C16H47E160

ComPacT NSX250H (70 kA 380/415V)

Rating	3P 3d	4P 4d, 3d + N/2
100 A	-	C25H47E100
160 A	-	C25H47E160
250 A	-	C25H47E250

Complete Fixed Device

ComPacT NSX100/160/250H (70 kA 380/415 V)

ComPacT NSX100/160/250H

With magnetic trip unit MA

DB438168.ai

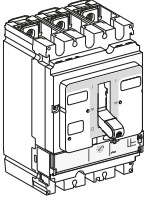

ComPacT NSX100H (70 kA at 380/415 V)

Rating	3P 3d
MA2.5	C10H3MA003
MA6.3	C10H3MA007
MA12.5	C10H3MA013
MA25	C10H3MA025
MA50	C10H3MA050
MA100	C10H3MA100

ComPacT NSX160H (70 kA at 380/415 V)

Rating	3P 3d
MA100	C16H3MA100
MA150	C16H3MA150

ComPacT NSX250H (70 kA at 380/415 V)

Rating	3P 3d
MA150	C25H3MA150
MA220	C25H3MA220

With electronic trip unit MicroLogic 2.2 M (LS₀I motor protection)

DB438166.ai

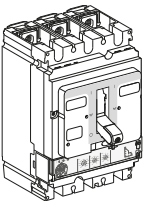

ComPacT NSX100H (70 kA at 380/415 V)

Rating	3P 3d
25 A	C10H32M025
50 A	C10H32M050
100 A	C10H32M100

ComPacT NSX160H (70 kA at 380/415 V)

Rating	3P 3d
100 A	C16H32M100
150 A	C16H32M150

ComPacT NSX250H (70 kA at 380/415 V)

Rating	3P 3d
150 A	C25H32M150
220 A	C25H32M220

Basic frames with breaking capacities B, F, N, H, S, L at 440 VAC + trip units that are not available as a commercial reference for the complete device, can be ordered only as a separate component or through the online configurator (Product Selector).

Please refer to the chapter A trip units sections to understand better the validity of a trip unit with the relevant basic frame.

Complete Fixed Device

ComPacT NSX100/250R (200 KA 380/415 V - 45 KA 690 V)

ComPacT NSX100/250R

With thermal-magnetic trip unit TM-D

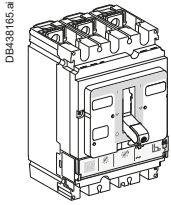

ComPacT NSX100R (200 kA at 380/415 V - 45 kA at 690 V)

Rating	3P 3d	4P 4d
TM40D	C10R3TM040	C10R4TM040
TM50D	C10R3TM050	C10R4TM050
TM63D	C10R3TM063	C10R4TM063
TM80D	C10R3TM080	C10R4TM080
TM100D	C10R3TM100	C10R4TM100

ComPacT NSX250R (200 kA at 380/415 V - 45 kA at 690 V)

Rating	3P 3d	4P 4d
TM125D	C25R3TM125	C25R4TM125
TM160D	C25R3TM160	C25R4TM160
TM200D	C25R3TM200	C25R4TM200
TM250D	C25R3TM250	C25R4TM250

With electronic trip unit MicroLogic 2.2 (LS_oI protection)

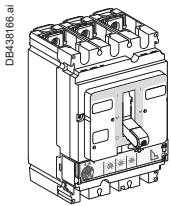

ComPacT NSX100R (200 kA at 380/415 V - 45 kA at 690 V)

Rating	3P 3d	4P 3d, 4d, 3d + N/2
40 A	C10R32D040	C10R42D040
100 A	C10R32D100	C10R42D100

ComPacT NSX250R (200 kA at 380/415 V - 45 kA at 690 V)

Rating	3P 3d	4P 3d, 4d, 3d + N/2
100 A	C25R32D100	C25R42D100
160 A	C25R32D160	C25R42D160
250 A	C25R32D250	C25R42D250

With electronic trip unit MicroLogic 5.2 E (LSI protection, energy meter)

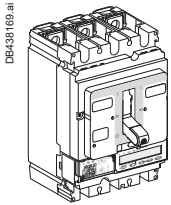

ComPacT NSX100R (200 kA at 380/415 V - 45 kA at 690 V)

Rating	3P 3d	4P 3d, 4d, 3d + N/2, OSN
40 A	C10R35E040	C10R45E040
100 A	C10R35E100	C10R45E100

ComPacT NSX250R (200 kA at 380/415 V - 45 kA at 690 V)

Rating	3P 3d	4P 3d, 4d, 3d + N/2, OSN
100 A	C25R35E100	C25R45E100
160 A	C25R35E160	C25R45E160
250 A	C25R35E250	C25R45E250

With electronic trip unit MicroLogic 6.2 E (LSIG protection, energy meter)

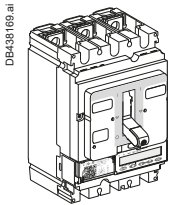

ComPacT NSX100R (200 kA at 380/415 V - 45 kA at 690 V)

Rating	3P 3d	4P 3d, 4d, 3d + N/2, OSN
40 A	C10R36E040	C10R46E040
100 A	C10R36E100	C10R46E100

ComPacT NSX250R (200 kA at 380/415 V - 45 kA at 690 V)

Rating	3P 3d	4P 3d, 4d, 3d + N/2, OSN
100 A	C25R36E100	C25R46E100
160 A	C25R36E160	C25R46E160
250 A	C25R36E250	C25R46E250

F

Complete Fixed Device

ComPacT NSX100/250R (200 kA 380/415 V - 45 kA 690 V)

ComPacT NSX100/250R

With magnetic trip unit MA

DB438168.ai

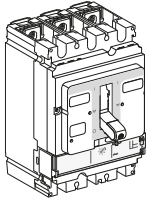

ComPacT NSX100R (200 kA at 380/415 V - 45 kA at 690 V)

Rating	3P 3d
MA12.5	C10R3MA013
MA25	C10R3MA025
MA50	C10R3MA050
MA100	C10R3MA100

ComPacT NSX250R (200 kA at 380/415 V - 45 kA at 690 V)

Rating	3P 3d
MA150	C25R3MA150
MA220	C25R3MA220

With electronic trip unit MicroLogic 2.2 M (LS_oI motor protection)

DB438169.ai

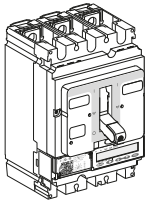

ComPacT NSX100R (200 kA at 380/415 V - 45 kA at 690 V)

Rating	3P 3d
25 A	C10R32M025
50 A	C10R32M050
100 A	C10R32M100

ComPacT NSX250R (200 kA at 380/415 V - 45 kA at 690 V)

Rating	3P 3d
150 A	C25R32M150
220 A	C25R32M220

With electronic trip unit MicroLogic 6.2 E-M (LSIG motor protection, energy meter)

DB438169.ai

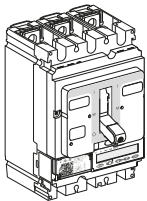

ComPacT NSX100R (200 kA at 380/415 V - 45 kA at 690 V)

Rating	3P 3d
25 A	C10R36M025
50 A	C10R36M050
80 A	C10R36M080

ComPacT NSX250R (200 kA at 380/415 V - 45 kA at 690 V)

Rating	3P 3d
150 A	C25R36M150
220 A	C25R36M220

Complete Fixed Device

ComPacT NSX100/250HB1 (85 KA 500 V - 75 KA 690 V)

ComPacT NSX100/250HB1

With thermal-magnetic trip unit TM-D

DB438108.ai

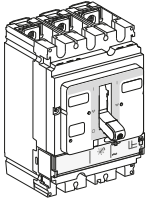

ComPacT NSX100HB1 (85 kA at 500 V - 75 kA at 690 V)

Rating	3P 3d	4P 4d
TM40D	C10V3TM040	C10V4TM040
TM50D	C10V3TM050	C10V4TM050
TM63D	C10V3TM063	C10V4TM063
TM80D	C10V3TM080	C10V4TM080
TM100D	C10V3TM100	C10V4TM100

ComPacT NSX250HB1 (85 kA at 500 V - 75 kA at 690 V)

Rating	3P 3d	4P 4d
TM125D	C25V3TM125	C25V4TM125
TM160D	C25V3TM160	C25V4TM160
TM200D	C25V3TM200	C25V4TM200
TM250D	C25V3TM250	C25V4TM250

With electronic trip unit MicroLogic 2.2 (LS_oI protection)

DB438106.ai

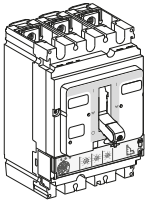

ComPacT NSX100HB1 (85 kA at 500 V - 75 kA at 690 V)

Rating	3P 3d	4P 3d, 4d, 3d + N/2
40 A	C10V32D040	C10V42D040
100 A	C10V32D100	C10V42D100

ComPacT NSX250HB1 (85 kA at 500 V - 75 kA at 690 V)

Rating	3P 3d	4P 3d, 4d, 3d + N/2
100 A	C25V32D100	C25V42D100
160 A	C25V32D160	C25V42D160
250 A	C25V32D250	C25V42D250

With electronic trip unit MicroLogic 5.2 E (LSI protection, energy meter)

DB438107.ai

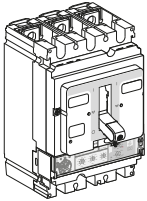

ComPacT NSX100HB1 (85 kA at 500 V - 75 kA at 690 V)

Rating	3P 3d	4P 3d, 4d, 3d + N/2, OSN
40 A	C10V35E040	C10V45E040
100 A	C10V35E100	C10V45E100

ComPacT NSX250HB1 (85 kA at 500 V - 75 kA at 690 V)

Rating	3P 3d	4P 3d, 4d, 3d + N/2, OSN
100 A	C25V35E100	C25V45E100
160 A	C25V35E160	C25V45E160
250 A	C25V35E250	C25V45E250

With electronic trip unit MicroLogic 6.2 E (LSIG protection, energy meter)

DB438109.ai

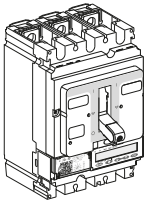

ComPacT NSX100HB1 (85 kA at 500 V - 75 kA at 690 V)

Rating	3P 3d	4P 3d, 4d, 3d + N/2, OSN
40 A	C10V36E040	C10V46E040
100 A	C10V36E100	C10V46E100

ComPacT NSX250HB1 (85 kA at 500 V - 75 kA at 690 V)

Rating	3P 3d	4P 3d, 4d, 3d + N/2, OSN
100 A	C25V36E100	C25V46E100
160 A	C25V36E160	C25V46E160
250 A	C25V36E250	C25V46E250

Complete Fixed Device

ComPacT NSX100/250HB1 (85 KA 500 V - 75 KA 690 V)

ComPacT NSX100/250HB1

With magnetic trip unit MA

DB438108.ai

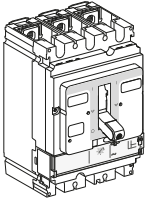

ComPacT NSX100HB1 (85 kA at 500 V - 75 kA at 690 V)

Rating	3P 3d
MA12.5	C10V3MA013
MA25	C10V3MA025
MA50	C10V3MA050
MA100	C10V3MA100

ComPacT NSX250HB1 (85 kA at 500 V - 75 kA at 690 V)

Rating	3P 3d
MA150	C25V3MA150
MA220	C25V3MA220

With electronic trip unit MicroLogic 2.2 M (LS_oI motor protection)

DB438166.ai

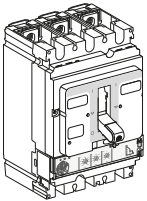

ComPacT NSX100HB1 (85 kA at 500 V - 75 kA at 690 V)

Rating	3P 3d
25 A	C10V32M025
50 A	C10V32M050
100 A	C10V32M100

ComPacT NSX250HB1 (85 kA at 500 V - 75 kA at 690 V)

Rating	3P 3d
150 A	C25V32M150
220 A	C25V32M220

With electronic trip unit MicroLogic 6.2 E-M (LSIG motor protection, energy meter)

DB438168.ai

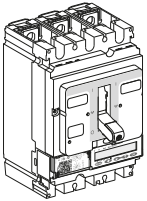

ComPacT NSX100HB1 (85 kA at 500 V - 75 kA at 690 V)

Rating	3P 3d
25 A	C10V36M025
50 A	C10V36M050
80 A	C10V36M080

ComPacT NSX250HB1 (85 kA at 500 V - 75 kA at 690 V)

Rating	3P 3d
150 A	C25V36M150
220 A	C25V36M220

Complete Fixed Device

ComPacT NSX100/250HB2 (100 kA 500 V - 100 kA 690 V)

ComPacT NSX100/250HB2

With thermal-magnetic trip unit TM-D

DB438105.ai

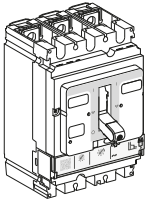

ComPacT NSX100HB2 (100 kA at 500 V - 100 kA at 690 V)

Rating	3P 3d	4P 4d
TM63D	C10W3TM063	C10W4TM063
TM80D	C10W3TM080	C10W4TM080
TM100D	C10W3TM100	C10W4TM100

ComPacT NSX250HB2 (100 kA at 500 V - 100 kA at 690 V)

Rating	3P 3d	4P 4d
TM125D	C25W3TM125	C25W4TM125
TM160D	C25W3TM160	C25W4TM160
TM200D	C25W3TM200	C25W4TM200
TM250D	C25W3TM250	C25W4TM250

With electronic trip unit MicroLogic 2.2 (LS₀I protection)

DB438106.ai

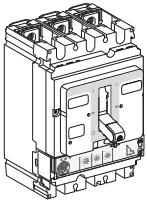

ComPacT NSX100HB2 (100 kA at 500 V - 100 kA at 690 V)

Rating	3P 3d	4P 3d, 4d, 3d + N/2
40 A	C10W32D040	C10W42D040
100 A	C10W32D100	C10W42D100

ComPacT NSX250HB2 (100 kA at 500 V - 100 kA at 690 V)

Rating	3P 3d	4P 3d, 4d, 3d + N/2
100 A	C25W32D100	C25W42D100
160 A	C25W32D160	C25W42D160
250 A	C25W32D250	C25W42D250

With electronic trip unit MicroLogic 5.2 E (LSI protection, energy meter)

DB438109.ai

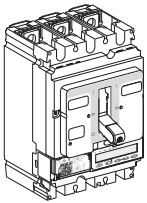

ComPacT NSX100HB2 (100 kA at 500 V - 100 kA at 690 V)

Rating	3P 3d	4P 3d, 4d, 3d + N/2, OSN
40 A	C10W35E040	C10W45E040
100 A	C10W35E100	C10W45E100

ComPacT NSX250HB2 (100 kA at 500 V - 100 kA at 690 V)

Rating	3P 3d	4P 3d, 4d, 3d + N/2, OSN
100 A	C25W35E100	C25W45E100
160 A	C25W35E160	C25W45E160
250 A	C25W35E250	C25W45E250

With electronic trip unit MicroLogic 6.2 E (LSIG protection, energy meter)

DB438109.ai

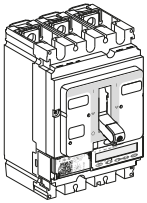

ComPacT NSX100HB2 (100 kA at 500 V - 100 kA at 690 V)

Rating	3P 3d	4P 3d, 4d, 3d + N/2, OSN
40 A	C10W36E040	C10W46E040
100 A	C10W36E100	C10W46E100

ComPacT NSX250HB2 (100 kA at 500 V - 100 kA at 690 V)

Rating	3P 3d	4P 3d, 4d, 3d + N/2, OSN
100 A	C25W36E100	C25W46E100
160 A	C25W36E160	C25W46E160
250 A	C25W36E250	C25W46E250

Complete Fixed Device

ComPacT NSX100/250HB2 (100 kA 500 V - 100 kA 690 V)

ComPacT NSX100/250HB2

With magnetic trip unit MA

DB438108.ai

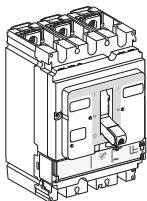

ComPacT NSX100HB2 (100 kA at 500 V - 100 kA at 690 V)

Rating	3P 3d
MA12.5	C10W3MA013
MA25	C10W3MA025
MA50	C10W3MA050
MA100	C10W3MA100

ComPacT NSX250HB2 (100 kA at 500 V - 100 kA at 690 V)

Rating	3P 3d
MA150	C25W3MA150
MA220	C25W3MA220

With electronic trip unit MicroLogic 2.2 M (LS_oI motor protection)

DB438106.ai

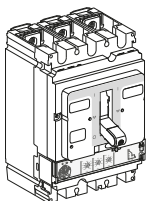

ComPacT NSX100HB2 (100 kA at 500 V - 100 kA at 690 V)

Rating	3P 3d
25 A	C10W32M025
50 A	C10W32M050
100 A	C10W32M100

ComPacT NSX250HB2 (100 kA at 500 V - 100 kA at 690 V)

Rating	3P 3d
150 A	C25W32M150
220 A	C25W32M220

With electronic trip unit MicroLogic 6.2 E-M (LSIG motor protection, energy meter)

DB438109.ai

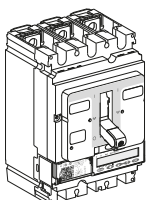

ComPacT NSX100HB2 (100 kA at 500 V - 100 kA at 690 V)

Rating	3P 3d
25 A	C10W36M025
50 A	C10W36M050
80 A	C10W36M080

ComPacT NSX250HB2 (100 kA at 500 V - 100 kA at 690 V)

Rating	3P 3d
150 A	C25W36M150
220 A	C25W36M220

Complete Fixed Device

ComPacT NSX100/160/250NA

ComPacT NSX100/160/250NA Switch-Disconnecter

With NA switch-disconnector unit

DE438770.ai

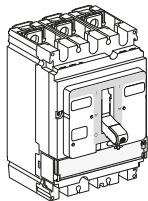

ComPacT NSX100NA

Rating	3P	4P
100 A	C103100S	C104100S

ComPacT NSX160NA

Rating	3P	4P
160 A	C163160S	C164160S

ComPacT NSX250NA

Rating	3P	4P
250 A	C253250S	C254250S

Based on Separate Components

ComPacT NSX100/160/250

Basic Frame

DB45871.ai

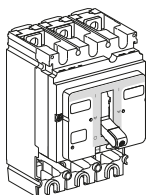

ComPacT NSX100

	3P	4P
NSX100B (25 kA 380/415 V)	C10B3	C10B4
NSX100F (36 kA 380/415 V)	C10F3	C10F4
NSX100N (50 kA 380/415 V)	C10N3	C10N4
NSX100H (70 kA 380/415 V)	C10H3	C10H4
NSX100S (100 kA 380/415 V)	C10S3	C10S4
NSX100L (150 kA 380/415 V)	C10L3	C10L4

ComPacT NSX160

	3P	4P
NSX160B (25 kA 380/415 V)	C16B3	C16B4
NSX160F (36 kA 380/415 V)	C16F3	C16F4
NSX160N (50 kA 380/415 V)	C16N3	C16N4
NSX160H (70 kA 380/415 V)	C16H3	C16H4
NSX160S (100 kA 380/415 V)	C16S3	C16S4
NSX160L (150 kA 380/415 V)	C16L3	C16L4

ComPacT NSX250

	3P	4P
NSX250B (25 kA 380/415 V)	C25B3	C25B4
NSX250F (36 kA 380/415 V)	C25F3	C25F4
NSX250N (50 kA 380/415 V)	C25N3	C25N4
NSX250H (70 kA 380/415 V)	C25H3	C25H4
NSX250S (100 kA 380/415 V)	C25S3	C25S4
NSX250L (150 kA 380/415 V)	C25L3	C25L4

+ Trip Unit

Distribution protection

DB112246.eps

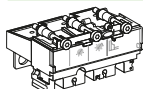

Thermal-magnetic TM-D

Rating	3P 3d	4P 3d	4P 4d
TM16D	C103TM016	C106TM016	C104TM016
TM25D	C103TM025	C106TM025	C104TM025
TM32D	C103TM032	C106TM032	C104TM032
TM40D	C103TM040	C106TM040	C104TM040
TM50D	C103TM050	C106TM050	C104TM050
TM63D	C103TM063	C106TM063	C104TM063
TM80D	C103TM080	C106TM080	C104TM080
TM100D	C103TM100	C106TM100	C104TM100
TM125D	C163TM125	C166TM125	C164TM125
TM160D ^[1]	C163TM160	C166TM160	C164TM160
TM160D ^[2]	C253TM160	C256TM160	C254TM160
TM200D	C253TM200	C256TM200	C254TM200
TM250D	C253TM250	C256TM250	C254TM250

MicroLogic 2.2 (LS₀I protection)

Rating	3P 3d	4P 3d, 4d, 3d + N/2
40 A	C1032D040	C1042D040
100 A	C1032D100	C1042D100
160 A	C1632D160	C1642D160
250 A	C2532D250	C2542D250

MicroLogic 5.2 E (LSI protection, energy meter)

Rating	3P 3d	4P 3d, 4d, 3d + N/2, 3d + OSN
40 A	C1035E040	C1045E040
100 A	C1035E100	C1045E100
160 A	C1635E160	C1645E160
250 A	C2535E250	C2545E250

MicroLogic 6.2 E (LSIG protection, energy meter)

Rating	3P 3d	4P 3d, 4d, 3d + N/2, 3d + OSN
40 A	C1036E040	C1046E040
100 A	C1036E100	C1046E100
160 A	C1636E160	C1646E160
250 A	C2536E250	C2546E250

[1] For NSX160.

[2] For NSX250.

DB112247.eps

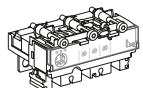

DB112248.eps

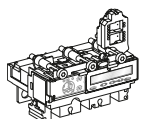

F

Based on Separate Components

ComPacT NSX100/160/250

+ Trip Unit (Cont.)

Distribution protection with embedded earth leakage protection

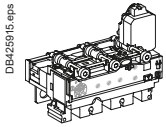

MicroLogic Vigi 4.2 (LS_oIR protection)

Rating	3P 3d	4P 4d 3d + N/2
40 A	C1034V040	C1044V040
100 A	C1034V100	C1044V100
160 A	C1634V160	C1644V160
250 A	C2534V250	C2544V250

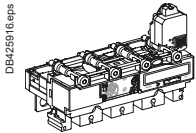

MicroLogic Vigi 7.2 E (LSIR protection)

Rating	3P 3d	4P 4d 3d + N/2
40 A	-	C1047E040
100 A	-	C1047E100
160 A	-	C1647E160
250 A	-	C2547E250

Distribution protection with embedded earth leakage alarm

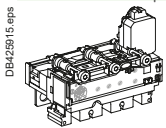

MicroLogic Vigi 4.2 AL (LS_oI protection + earth leakage alarm)

Rating	3P 3d	4P 4d 3d + N/2
40 A	C1034A040	C1044A040
100 A	C1034A100	C1044A100
160 A	C1634A160	C1644A160
250 A	C2534A250	C2544A250

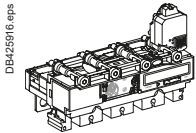

MicroLogic Vigi 7.2 E AL (LSI protection + earth leakage alarm)

Rating	3P 3d	4P 4d 3d + N/2
40 A	-	C1047A040
100 A	-	C1047A100
160 A	-	C1647A160
250 A	-	C2547A250

Motor protection

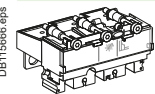

Magnetic MA (I protection)

Rating	3P 3d	4P 3d
MA2.5	C103MA003	
MA6.3	C103MA007	
MA12.5	C103MA013	
MA25	C103MA025	
MA50	C103MA050	
MA100	C103MA100	C106MA100
MA150	C163MA150	C166MA150
MA220	C253MA220	C256MA220

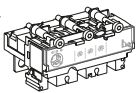

MicroLogic 2.2 M (LS_oI protection)

Rating	3P 3d
25 A	C1032M025
50 A	C1032M050
100 A	C1032M100
150 A	C1632M150
220 A	C2532M220

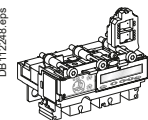

MicroLogic 6.2 E-M (LSIG protection, energy meter)

Rating	3P 3d
25 A	C1036M025
50 A	C1036M050
80 A	C1036M080
150 A	C1636M150
220 A	C2536M220

Generator protection

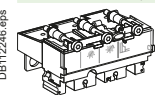

Thermal-magnetic TM-G

Rating	3P 3d	4P 4d
TM16G	C103MG016	C104MG016
TM25G	C103MG025	C104MG025
TM40G	C103MG040	C104MG040
TM63G	C103MG063	C104MG063
TM80G	C103MG080	C104MG080
TM100G	C103MG100	C104MG100
TM125G	C163MG125D	C164MG125D
TM160G	C163MG160D	C164MG160D
TM200G	C253MG200D	C254MG200D
TM250G	C253MG250D	C254MG250D

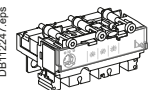

MicroLogic 2.2 G (LS_oI protection)

Rating	3P 3d	4P 3d, 4d, 3d + N/2
40 A	C1032G040	C1042G040
100 A	C1032G100	C1042G100
160 A	C1632G160	C1642G160
250 A	C2532G250	C2542G250

F

Based on Separate Components

ComPacT NSX100/160/250

+ Trip Unit (Cont.)

Protection of public distribution systems

DB112247.eps

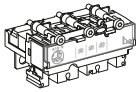

MicroLogic 2.2 AB (LS₀I protection)

Rating	4P 3d, 4d, 3d + N/2
100 A	C1042B100
160 A	C1642B160
240 A	C2542B240

Earth Leakage protection of public distribution systems

MicroLogic Vigi 4.2 AB distribution protections

Rating	4P 3d, 4d, 3d + N/2
100 A	C1044B100
160 A	C1644B160
250 A	C2544B250

16 Hz 2/3 network protection

DB112248.eps

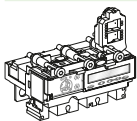

MicroLogic 5.2 A-Z (LSI protection)

Rating	3P 3d
100 A	C1035Z100
250 A	C2535Z250

+ VigiPacT Add-on Protection and Alarm Modules

VigiPacT add-on protection

DB112249.eps

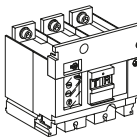

	3P	4P
NSX100/160 (200 to 440 V)	LV429488	LV429489
NSX250 (200 to 440 V)	LV429492	LV429493
NSX100/160 (440 to 550 V)	LV429490	LV429491
NSX250 (440 to 550 V)	LV429494	LV429495
Connection for a 4P VigiPacT on a 3P breaker		LV429214

VigiPacT add-on alarm

DB112246.eps

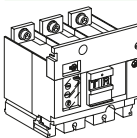



	3P	4P
200 to 440 V AC	LV429498	LV429499
Connection for a 4P insulation monitoring module on a 3P breaker		LV429214

Catalog Numbers

Trip Unit Accessories

ComPacT NSX100/160/250

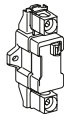
Trip Unit Accessories

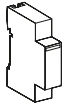
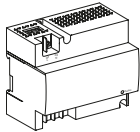
External neutral CT for 3 pole breaker with MicroLogic 5/6		
 DB112733.eps	25-100 A	LV429521
	150-250 A	LV430563
24 V DC wiring accessory for MicroLogic 5/6		
 DB112730.eps	24 Vdc Terminal Block and SD Auxiliary Contact for BSCM Modbus SL/ULP	LV434210
ZSI wiring accessory for NS630b NW with NSX		
 DB115665.eps	ZSI module	LV434212
MicroLogic power supply (24 V DC - 1 A), OVC IV		
 DB432608.eps	24-30 V DC	LV454440
	48-60 V DC	LV454441
	100-125 V DC	LV454442
	110-130 V AC	LV454443
	200-240 V AC	LV454444

Installation and Connection

ComPacT NSX100/160/250

Fixed/RC Device = Fixed/FC Device + Rear Connection Kit

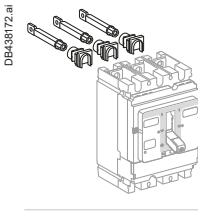

Short RC kit			
Kit 3P		3 x	LV429235
Kit 4P		4 x	LV429235
Mixed RC kit			
Kit 3P	Short RCs	2 x	LV429235
	Long RCs	1 x	LV429236
Kit 4P	Short RCs	2 x	LV429235
	Long RCs	2 x	LV429236

Plug-in Version = Fixed/FC Device + Plug-in Kit

Kit for ComPacT NSX

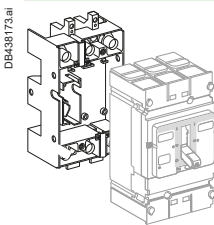

	3P	4P
Plug-in kit	LV429289	LV429290
Comprising:		
Base	= 1 x LV429266	= 1 x LV429267
Power connections	+ 3 x LV429268	+ 4 x LV429268
Short terminal shields	+ 2 x LV429515	+ 2 x LV429516
Safety trip interlock	+ 1 x LV429270	+ 1 x LV429270

Kit for ComPacT NSX Vigi Add-on

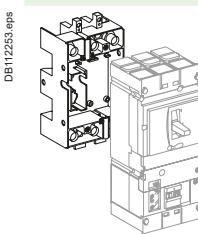

	3P	4P
Vigi Add-on plug-in kit	LV429291	LV429292
Comprising:		
Base	= 1 x LV429266	= 1 x LV429267
Power connections	+ 3 x LV429269	+ 4 x LV429269
Short terminal shields	+ 2 x LV429515	+ 2 x LV429516
Safety trip interlock	+ 1 x LV429270	+ 1 x LV429270

Withdrawable Version = Fixed/FC Device + Withdrawable Kit

Kit for ComPacT NSX

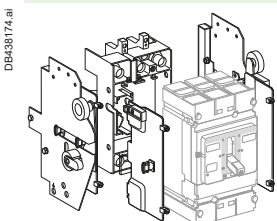

	3P	4P
	Kit for ComPacT NSX	Kit for ComPacT NSX
Plug-in kit	= 1 x LV429289	= 1 x LV429290
Chassis side plates for base	+ 1 x LV429282	+ 1 x LV429282
Chassis side plates for breaker	+ 1 x LV429283	+ 1 x LV429283

Kit for ComPacT NSX Vigi Add-on

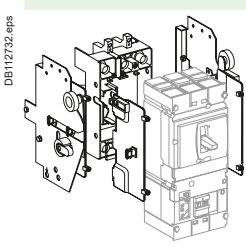

	3P	4P
	Kit for Vigi Add-on	Kit for Vigi Add-on
Plug-in kit	= 1 x LV429291	= 1 x LV429292
Chassis side plates for base	+ 1 x LV429282	+ 1 x LV429282
Chassis side plates for breaker	+ 1 x LV429283	+ 1 x LV429283



Accessories and Auxiliaries

ComPacT NSX100/160/250

Connection Accessories (Cu or Al)

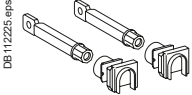
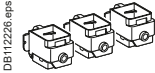
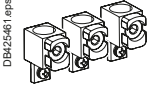
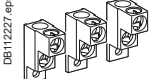
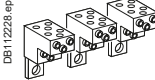
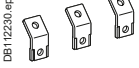
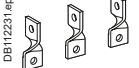
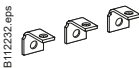
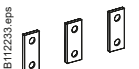
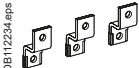
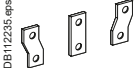
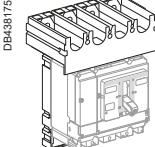
Rear connections					
	2 short		LV429235		
	2 long		LV429236		
Bare cable connectors					
	Steel connectors	1 x (1.5 to 95 mm ²) ; ≤ 160 A	Set of 2 Set of 3 Set of 4	LV429246 LV429242 LV429243	
		Aluminium connectors	1 x (25 to 95 mm ²) ; ≤ 250 A	Set of 2 Set of 3 Set of 4	LV429255 LV429227 LV429228
			1 x (120 to 185 mm ²) ; ≤ 250 A	Set of 2 Set of 3 Set of 4	LV429247 LV429259 LV429260
1 x (120 to 240 mm ²) ; ≤ 250 A	Set of 3 Set of 4		LV429244 LV429245		
	Clips for connectors		Set of 10	LV429241	
		Aluminium connectors for 2 cables ^[1]	2 x (50 to 120 mm ²) ; ≤ 250 A	Set of 3 Set of 4	LV429218 LV429219
	Aluminium connectors ^[1] for 6 cables	6 x (1.5 to 35 mm ²) ; ≤ 250 A	Set of 3 Set of 4	LV429248 LV429249	
		6.35 mm voltage tap for aluminium connectors for 1 or 2 cables	Set of 10	LV429348	
	Linerigy DX and Linerigy DP distribution block (for bare cable)	160 A (40 °C) 6 cables S ≤ 10 mm ²	1P	04031	
		250 A (40 °C) 9 cables S ≤ 10 mm ²	3P	04033	
			4P	04034	
Terminal extensions					
	45° terminal extension ^[1]		Set of 3 Set of 4	LV429223 LV429224	
		Edgewise terminal extensions ^[1]	Set of 3 Set of 4	LV429308 LV429309	
	Right-angle terminal extensions ^[1]		Set of 3 Set of 4	LV429261 LV429262	
		Straight terminal extensions ^[1]	Set of 3 Set of 4	LV429263 LV429264	
	Double-L terminal extensions ^[1]		Set of 3 Set of 4	LV429221 LV429222	
		Spreaders from 35 to 45 mm pitch ^[1]	3P 4P	LV431563 LV431564	
	One-piece spreader from 35 to 45 mm pitch		3P 4P	LV431060 LV431061	
					
					
					

[1] Supplied with 2 or 3 interphase barriers.

Accessories and Auxiliaries

ComPacT NSX100/160/250

Crimp lugs for copper cable ^[1]

DB11237.eps

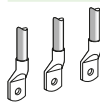

For cable 120 mm ²	Set of 3	LV429252
	Set of 4	LV429256
For cable 150 mm ²	Set of 3	LV429253
	Set of 4	LV429257
For cable 185 mm ²	Set of 3	LV429254
	Set of 4	LV429258

Crimp lugs for aluminium cable ^[1]

DB11238.eps

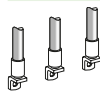

For cable 150 mm ²	Set of 3	LV429504
	Set of 4	LV429505
For cable 185 mm ²	Set of 3	LV429506
	Set of 4	LV429507

Insulation accessories

DB425457.eps



1 short terminal shield for breaker or plug-in base	3P	LV429515
	4P	LV429516

DB425458.eps

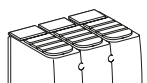

1 long terminal shield for breaker or plug-in base	3P	LV429517
	4P	LV429518

DB425459.eps



Interphase barriers for breaker or plug-in base	Set of 6	LV429329
---	----------	----------

DB425460.eps



Connection adapter for plug-in base	3P	LV429306
	4P	LV429307

DB43176.ai

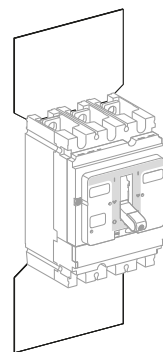

2 insulating screens for breaker (45 mm pitch)	3P	LV429330
	4P	LV429331

[1] Supplied with 2 or 3 interphase barriers.



Accessories and Auxiliaries

ComPacT NSX100/160/250

Electrical Auxiliaries

Auxiliary contacts (screwless, screw)

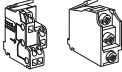
DB438418.ai		OF or SD or SDE or SDV [1] screwless type	29450
		OF or SD or SDE or SDV [1] screw type	29452
		SDE adapter, mandatory for trip unit TM, MA or MicroLogic 2	LV429451

Wireless indication auxiliary

DB438243.ai		OF or SD or SDE wireless	LV429454
-------------	---	--------------------------	----------

SDx output module for MicroLogic

DB112275.eps		SDx module 24/415 V AC/DC screw type	LV429532
--------------	---	--------------------------------------	----------

SDTAM contactor tripping module (early-break thermal fault signal) for MicroLogic 2.2 M/6.2 E-M

DB112276.eps		SDTAM 24/415 V AC/DC overload fault indication	LV429424
--------------	--	--	----------

Voltage releases

DB438273.ai			Voltage	MX	MN	
		AC	24 V 50/60 Hz	LV429384	LV429404	
			48 V 50/60 Hz	LV429385	LV429405	
			110-130 V 50/60 Hz	LV429386	LV429406	
			220-240 V 50/60 Hz and 208-277 V 60 Hz	LV429387	LV429407	
			380-415 V 50 Hz and 440-480 V 60 Hz	LV429388	LV429408	
			525 V 50 Hz and 600 V 60 Hz	LV429389	LV429409	
		DC	12 V	LV429382	LV429402	
			24 V	LV429390	LV429410	
			30 V	LV429391	LV429411	
			48 V	LV429392	LV429412	
			60 V	LV429383	LV429403	
			125 V	LV429393	LV429413	
			250 V	LV429394	LV429414	
				MN 48 V 50/60 Hz with fixed time delay		
			Composed of:	MN 48 V DC		LV429412
	Delay unit 48 V 50/60 Hz			LV429426		
	MN 220-240 V 50/60 Hz with fixed time delay					
Composed of:	MN 250 V DC		LV429414			
	Delay unit 220-240 V 50/60 Hz		LV429427			
	MN 48 V DC/AC 50/60 Hz with adjustable time delay					
Composed of:	MN 48 V DC		LV429412			
	Delay unit 48 V DC/AC 50/60 Hz		33680			
	MN 110-130 V DC/AC 50/60 Hz with adjustable time delay					
Composed of:	MN 125 V DC		LV429413			
	Delay unit 100-130 V DC/AC 50/60 Hz		33681			
	MN 220-250 V DC/AC 50/60 Hz with adjustable time delay					
Composed of:	MN 250 V DC		LV429414			
	Delay unit 200-250 V DC/AC 50-60 Hz		33682			

[1] Only when using a VigiPacT Add-on block adapted to the complete device.

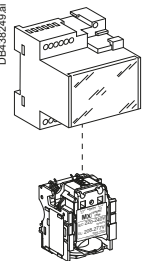

Accessories and Auxiliaries

ComPacT NSX100/160/250

Motor Mechanism

Motor mechanism module supplied with SDE adapter

DB125554.eps

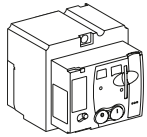

	Voltage	MT100/160	MT250
AC	48-60 V 50/60 Hz	LV429440	LV431548
	110-130 V 50/60 Hz	LV429433	LV431540
	220-240 V 50/60 Hz and 208-277 V 60 Hz	LV429434	LV431541
	380-415 V 50/60 Hz and 440-480 V 60 Hz	LV429435	LV431542
	DC		
DC	24-30 V	LV429436	LV431543
	48-60 V	LV429437	LV431544
	110-130 V	LV429438	LV431545
	250 V	LV429439	LV431546

Communicating motor mechanism module supplied with SDE adapter

DB445844.eps

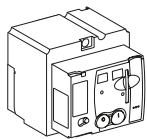

	Voltage	MTc100/160	MTc250
Motor mechanism module	220-240 V 50/60 Hz	LV429441	LV431549
	24 VDC	LV429442	LV431550

+

Breaker and Status
Communication Module

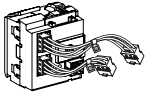

ComPacT NSX BSCM Modbus SL/ULP	LV434220
ComPacT NSX Com Modbus SL Cord 0.35 m	LV434221
ComPacT NSX Com Modbus SL Cord 1.3 m	LV434222
ComPacT NSX Com Modbus SL Cord 3 m	LV434223
Modbus SL Hub	LV434224

+

NSX cord

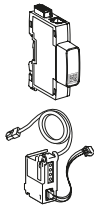

Wire length L = 0.35 m	LV434200
Wire length L = 1.3 m	LV434201
Wire length L = 3 m	LV434202
U > 480 V AC wire length L = 1.3 m	LV434204



Accessories and Auxiliaries

ComPacT NSX100/160/250

Indication and Measurement Modules

PowerLogic PowerTag NSX

	Rating (A)	250	
	3P	LV434020	
	3P+N	LV434021	

Current transformer module and voltage output

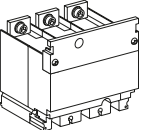
	Rating (A)	125	150	250
	3P	LV429461	LV430561	LV431569
	4P	LV429462	LV430562	LV431570

Rotary Handles

Direct rotary handle

	With black handle	LV429337T
	With red handle on yellow front	LV429339T
	MCC conversion accessory	LV429341T
	CNOMO conversion accessory	LV429342T

Extended rotary handle

	With black handle	LV429338T
	With red handle on yellow front	LV429340T
	With telescopic handle for withdrawable device	LV429343T

	Open door shaft operator	LV426937
---	--------------------------	----------

Accessories for direct or extended rotary handle

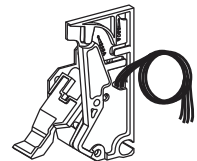
	Indication auxiliary	1 early-break contact	LV429345
		2 early-make contacts	LV429346

F

Locks

Toggle locking device for 1 to 3 padlocks

DB438179.ai	By removable device	29370
-------------	---------------------	--------------

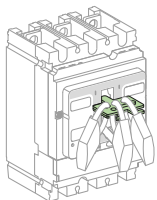

DB438180.ai	By fixed device for 3P-4P (open or close position)	LV429371T
	By fixed device for 3P-4P (open position only)	LV429370T

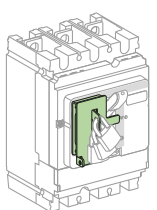

Locking of rotary handle

DB439008.ai	Keylock adapter (keylock not included)	LV429344
	Keylock (keylock adapter not included)	41940
	Profalux KS5 B24 D4Z	42888

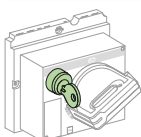

Locking of motor mechanism module

DB424605.eps	Keylock adapter + Ronis keylock (special)	LV429449
--------------	---	-----------------

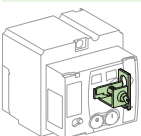

Accessories and Auxiliaries

ComPacT NSX100/160/250

Interlocking

Mechanical interlocking for circuit breakers

 <p>DB439636.ai</p>	With toggles	LV429354T
	With direct rotary handle	LV429369T
 <p>DB439009.ai</p>	With extended rotary handle	LV429369ET

Interlocking with key (2 keylocks/1 key) for rotary handles

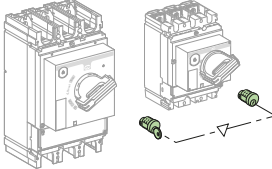
 <p>DB439010.ai</p>	Keylock kit (keylock not included) ^[1]	LV429344	
	1 set of 2 keylocks	Ronis 1351B.500	41950
	(1 key only, keylock kit not included)	Profalux KS5 B24 D4Z	42878

Installation Accessories

Front-panel escutcheons

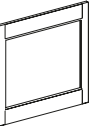
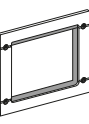
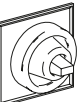
 <p>DB 112269.eps</p> <p>IP30</p>	IP30 escutcheon for all control types	LV429525
	IP30 trip unit access escutcheon for toggle	LV429526
	IP30 escutcheon for VigiPacT add-on	LV429527
 <p>DB 112737.eps</p> <p>IP40</p>	IP40 escutcheon for all control types	LV429317
	IP40 escutcheon for VigiPacT add-on	LV429316
	IP40 escutcheon for VigiPacT add-on or ammeter module	LV429318
 <p>DB 112738.eps</p>	IP43 rubber toggle cover	
	1 toggle cover	LV429319 ^[2]

Lead-sealing accessories

 <p>DB 116615.eps</p>	Bag of accessories	LV429375
--	--------------------	----------

Din rail adapter

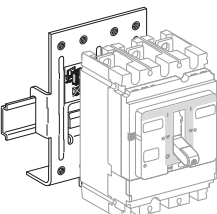
 <p>DB438185.ai</p>	1 adapter	LV429305
--	-----------	----------











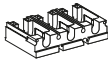

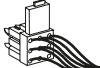

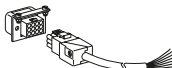
60 Mm Plate

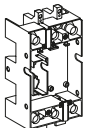
 <p>DB438186.ai</p>	Plate 3P ComPacT NSX100/250 IEC	LV429372
	Plate 4P ComPacT NSX100/250 IEC	LV429373

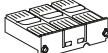
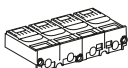
[1] For only 1 device.

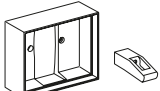
[2] Applicable with old front cover only. Need to order LV429313T, toggle extension to be compatible for IP43 rubber cover.

Plug-in/Withdrawable Version Accessories







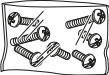

Insulation accessories			
DB117159.eps 	1 connection adapter for plug-in base	3P	LV429306
		4P	LV429307
Auxiliary connections			
DB117160.eps 	1 9-wire fixed connector (for base)		LV429273
DB117161.eps 	1 9-wire moving connector (for circuit breaker)		LV429274
DB117162.eps 	1 support for 2 moving connectors		LV429275
DB115935.eps 	9-wire manual auxiliary connector (fixed + moving)		LV429272
Plug-in base accessories			
DB432605.eps 	2 long insulated right angle terminal extensions	Set of 2	LV429276
DB117165.eps 	2 IP40 shutters for base		LV429271
DB117166.eps 	Base	2P (3P base)	LV429265
		3P	LV429266
DB117167.eps 	Base	4P	LV429267
DB117168.eps 	2 power connections	2/3/4P	LV429268
DB117169.eps 	1 short terminal shield	2/3P	LV429515
DB117170.eps 	1 short terminal shield	4P	LV429516
DB117171.eps 	1 safety trip interlock	2/3/4P	LV429270
Chassis accessories			
DB117172.eps 	Escutcheon collar	Toggle	LV429284 ^[1]
DB117173.eps 	Escutcheon collar	VigiPacT add-on	LV429285
DB117163.eps 	Locking kit (keylock not included)		LV429286
		Keylock (keylock adapter not included)	Ronis 1351B.500 Profalux KS5 B24 D4Z
DB11426.eps 	2 carriage switches (connected/disconnected position indication)		LV429287

[1] Need to order LV434435, NSX front cover to be compatible for escutcheon collar for toggle.

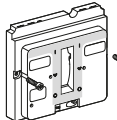
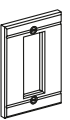
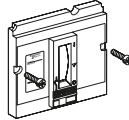
Accessories and Auxiliaries

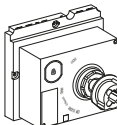
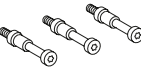
ComPacT NSX100/160/250

Spare Parts

 DB44688.eps	10 spare toggle extensions (NSX250)		LV429313T
 DB11520.eps	Bag of screws		LV429312
 DB111431.eps	12 snap-in nuts (fixed/FC)	M6 for NSX100N/H/L M8 for NSX160/250N/H/L	LV429234 LV430554
 DB438167.ai	NSX100-250 front cover	3P/4P	LV434435
	Retrofit NSX100-250 front cover	3P/4P	LV43435AT
 DB111433.eps	IP40 toggle escutcheon	ComPacT NS type/small cut-out	29315
 DB111432.eps	NS retrofit escutcheon	Small cut-out	LV429528
 DB111438.eps	1 set of 10 identification labels		LV429226
 DB439188.ai	1 base for extended rotary handle		LV429502T
 DB111434.eps	Torque limiting screws (set of 12)	3P/4P ComPacT NSX100-250	LV429513
 DB111435.eps	LCD display for electronic trip unit	MicroLogic 5 MicroLogic 6 MicroLogic 6 E-M MicroLogic 7	LV429483 LV429484 LV429486 LV429485
 DB111436.eps	5 transparent covers for trip unit	TM, MA, NA MicroLogic 2 MicroLogic 5/6	LV429481 LV429481 LV429478
 DB446110.ai	ULP cable (set of 15)	MicroLogic 7	LV429471
	ENVT kit	MicroLogic 5/6	LV429470

Visible Break Disconnect Function

See catalog dealing with "ComPacT INV products (visible break)" and the associated accessories.
The visible break disconnection function is compatible with fixed front-connected/rear-connected ComPacT NSX devices.

F

Communication Option

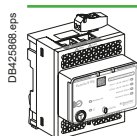
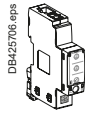
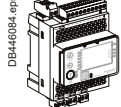
	IFE	Ethernet interface for LV breakers and gateway	LV434002
	IFM Modbus-SL interface module		LV434000
	I/O application module		LV434063

Monitoring and Control (Remote Operation)

Circuit breaker accessories

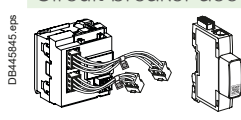
	Breaker Status Control Module	ComPacT NSX BSCM Modbus SL/ULP ^[1]	LV434220
		ComPacT NSX Com Modbus SL Cord 0.35 m	LV434221
		ComPacT NSX Com Modbus SL Cord 1.3 m	LV434222
		ComPacT NSX Com Modbus SL Cord 3 m	LV434223
		Modbus SL Hub	LV434224

ULP display module^[2]

	Switchboard front display module FDM121	TRV00121
	FDM mounting accessory (diameter 22 mm)	TRV00128



Ethernet display module

	Switchboard front display module FDM128	LV434128
---	---	----------

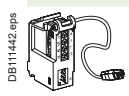
ULP wiring accessories

	NSX cord L = 0.35 m	LV434200
	NSX cord L = 1.3 m	LV434201
	NSX cord L = 3 m	LV434202
	NSX cord for U > 480 V AC L = 1.3 m	LV434204

	10 stacking connectors for communication interface modules	TRV00217
---	--	----------

 	2 Modbus line terminators used with screw connection	VW3A8306DRC
	Modbus line terminators used with RJ45 connections	VW3A8306RC

	Connector Modbus adaptor	LV434211
---	--------------------------	----------

	RS 485 roll cable (4 wires, length 60 m)	50965
---	--	-------

	5 RJ45 connectors female/female	TRV00870
---	---------------------------------	----------

	10 ULP line terminators	TRV00880
---	-------------------------	----------





	10 RJ45/RJ45 male cord L = 0.3 m	TRV00803
	10 RJ45/RJ45 male cord L = 0.6 m	TRV00806
	5 RJ45/RJ45 male cord L = 1 m	TRV00810
	5 RJ45/RJ45 male cord L = 2 m	TRV00820
	5 RJ45/RJ45 male cord L = 3 m	TRV00830
	1 RJ45/RJ45 male cord L = 5 m	TRV00850

[1] SDE adapter mandatory for trip unit TM, MA or MicroLogic 2 (LV429451).
 [2] For measurement display with MicroLogic E or status display with BSCM Modbus SL/ULP.

Accessories and Auxiliaries

ComPacT NSX100/160/250

Test Tool, Software, Demo

Test tool		
	Pocket battery for MicroLogic NSX100-630	LV434206
Mini test kit		
	Hand held test kit (HHTK)	33594
Service Interface Test Kit		
	BTM (Breaker Test Module)	LV485500
	Service interface spare part	LV485510SP
	Service interface AC/DC power	LV485511SP
	Service interface 7 pin cable ACB MCCB TU	LV485512SP
	Service interface ULP cable	LV485514SP
	Service interface USB magnet cable	LV485517SP
	Bluetooth/Modbus option for USB maintenance interface	VW3A8114

Accessories

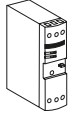
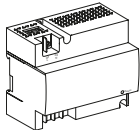
Power supply modules		
	External power supply module 100-240 V AC 110-230 V DC/24 V DC-3 A class 2	ABL8RPS24030
	MicroLogic power supply 24 V DC-1 A OVC IV	
	24-30 V DC	LV454440
	48-60 V DC	LV454441
	100-125 V DC	LV454442
	110-130 V AC	LV454443
	200-240 V AC	LV454444

F

F



F

Catalog Numbers: ComPacT NSX400-630

Complete Fixed Device

ComPacT NSX400/630F (36 KA 380/415 V)	F-50
ComPacT NSX400/630N (50 KA 380/415 V).....	F-51
ComPacT NSX400/630H (70 KA 380/415 V).....	F-52
ComPacT NSX400/630R (200 KA 380/415 V - 45 KA 690 V)	F-53
ComPacT NSX400/630HB1 (85 KA 500 V - 75 KA 690 V).....	F-54
ComPacT NSX400/630HB2 (85 KA 500 V - 100 KA 690 V).....	F-55
ComPacT NSX400/630NA	
ComPacT NSX400K (10 KA - 1000V AC).....	F-56

Based on Separate Components

ComPacT NSX400/630	F-57
--------------------------	------

Trip Unit Accessories

ComPacT NSX400/630	F-59
--------------------------	------

Installation and Connection

ComPacT NSX400/630	F-60
--------------------------	------

Accessories and Auxiliaries

ComPacT NSX400/630	F-61
--------------------------	------

Communication, Monitoring and Control

ComPacT NSX400/630	F-69
--------------------------	------

Monitoring and Control, Accessories

ComPacT NSX400/630	F-70
--------------------------	------

Source-Changeover Systems for 2 Devices

ComPacT NSX100 to NSX630	F-71
--------------------------------	------

NSX100/400 Utilities,

"Tarif Jaune" Public Distribution	F-73
---	------

ComPacT NSX100 to NSX630 Order Form	F-76
---	------



Other Chapters

Select Circuit Breakers and Switch-Disconnectors	A-1
Select Protection	B-1
Customize Circuit Breakers with Accessories.....	C-1
Smart Panel Integration	D-1
Switchboard Integration.....	E-1
Glossary	G-1
Additional Characteristics.....	H-1

Complete Fixed Device

ComPacT NSX400/630 TMD

ComPacT NSX400/630F

With thermal-magnetic trip unit TM-D

DB446736.ai

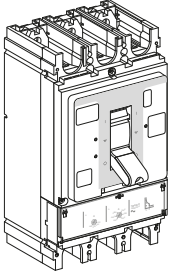

		3P 3d	4P 4d
ComPacT NSX400F (36kA 380/415V)	400 A	C40F3TM400	C40F4TM400
ComPacT NSX630F (36kA 380/415V)	630 A	C63F3TM630	C63F4TM630

ComPacT NSX400/630N

With thermal-magnetic trip unit TM-D

DB446736.ai

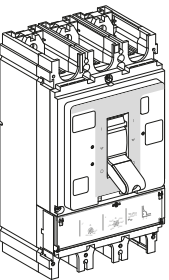

		3P 3d	4P 4d
ComPacT NSX400N (50kA 380/415V)	400 A	C40N3TM400	C40N4TM400
ComPacT NSX630N (50kA 380/415V)	630 A	C63N3TM630	C63N4TM630

ComPacT NSX400/630H

With thermal-magnetic trip unit TM-D

DB446736.ai

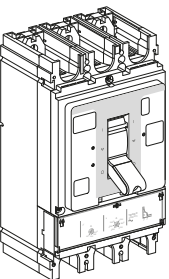

		3P 3d	4P 4d
ComPacT NSX400H (70kA 380/415V)	400 A	C40H3TM400	C40H4TM400
ComPacT NSX630H (70kA 380/415V)	630 A	C63H3TM630	C63H4TM630

Complete Fixed Device

ComPacT NSX400/630F (36 KA 380/415 V)

ComPacT NSX400/630F

Electronic trip unit MicroLogic 2.3 (LS₀I protection)

DB438108.ai

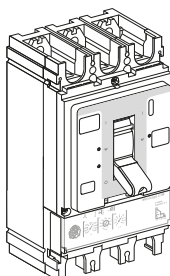

		3P 3d	4P 3d, 4d, 3d + N/2
ComPacT NSX400F (36 kA at 380/415 V)	250 A	C40F32D250	C40F42D250
	400 A	C40F32D400	C40F42D400
ComPacT NSX630F (36 kA at 380/415 V)	630 A	C63F32D630	C63F42D630

Electronic trip unit MicroLogic Vigi 4.3 (LS₀IR protection)

DB438190.ai

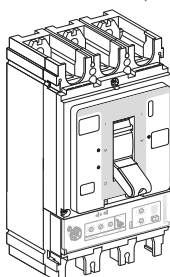

		3P 3d	4P 4d, 3d + N/2
ComPacT NSX400F (36 kA at 380/415 V)	400 A	C40F34V400	C40F44V400
	570 A	C63F34V570	C63F44V570

Electronic trip unit MicroLogic Vigi 7.3 E (LSIR protection + embedded energy management)

DB438568.ai

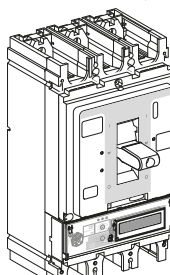

		3P 3d	4P 4d, 3d + N/2
ComPacT NSX400F (36 kA at 380/415V)	400 A	C40F37E400	C40F47E400
	570 A	C63F37E570	C63F47E570

Electronic trip unit MicroLogic 1.3 M (I motor protection)

DB438191.ai

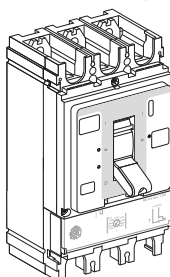

		3P 3d
ComPacT NSX400F 1.3 M (36 kA at 380/415V)	320 A	C40F31M320
	500 A	C63F31M500

Electronic trip unit MicroLogic 2.3 M (LS₀I motor protection)

DB438192.ai

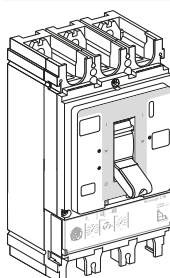

		3P 3d
ComPacT NSX400F 2.3 M (36 kA at 380/415V)	320 A	C40F32M320
	500 A	C63F32M500



Complete Fixed Device

ComPacT NSX400/630N (50 KA 380/415 V)

ComPacT NSX400/630N

Electronic trip unit MicroLogic 2.3 (LS₀I protection)

DB438189.ai

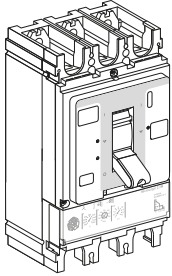

ComPacT NSX400N (50 kA at 380/415 V)	250 A	3P 3d C40N32D250	4P 3d, 4d, 3d + N/2 C40N42D250
	400 A	C40N32D400	C40N42D400
ComPacT NSX630N (50 kA at 380/415 V)	630 A	C63N32D630	C63N42D630

Electronic trip unit MicroLogic Vigi 4.3 (LS₀IR protection)

DB438190.ai

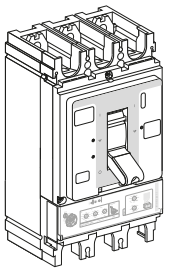

ComPacT NSX400N (50 kA at 380/415 V)	400 A	3P 3d C40N34V400	4P 4d 3d + N/2 C40N44V400
ComPacT NSX630N (50 kA at 380/415 V)	570 A	C63N34V570	C63N44V570

Electronic trip unit MicroLogic Vigi 7.3 E (LSIR protection + embedded energy management)

DB438568.ai

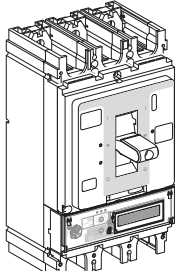

ComPacT NSX400N (36 kA at 380/415V)	400 A	3P 3d C40N37E400	4P 4d, 3d + N/2 C40N47E400
ComPacT NSX630N (36 kA at 380/415V)	570 A	C63N37E570	C63N47E570

Electronic trip unit MicroLogic 1.3 M A (I motor protection)

DB438191.ai

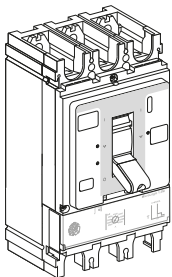

ComPacT NSX400N 1.3 M (50 kA at 380/415V)	320 A	3P 3d C40N31M320	
ComPacT NSX630N 1.3 M (50 kA at 380/415V)	500 A	C63N31M500	

Electronic trip unit MicroLogic 2.3 M (LS₀I motor protection)

DB438192.ai

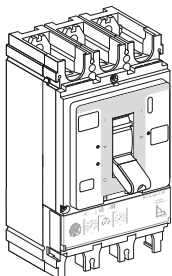

ComPacT NSX400N 2.3 M (50 kA at 380/415V)	320 A	3P 3d C40N32M320	
ComPacT NSX630N 2.3 M (50 kA at 380/415V)	500 A	C63N32M500	

Complete Fixed Device

ComPacT NSX400/630H (70 KA 380/415 V)

ComPacT NSX400/630H

Electronic trip unit MicroLogic 2.3 (LS₀I protection)

DB438189.ai

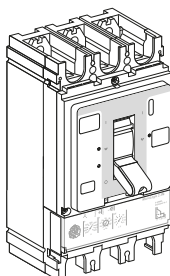

		3P 3d	4P 3d, 4d, 3d + N/2
ComPacT NSX400H (70 kA at 380/415 V)	250 A	C40H32D250	C40H42D250
	400 A	C40H32D400	C40H42D400
ComPacT NSX630H (70 kA at 380/415 V)	630 A	C63H32D630	C63H42D630

Electronic trip unit MicroLogic Vigi 4.3 (LS₀IR protection)

DB438190.ai

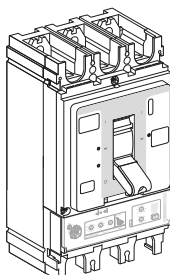

		3P 3d	4P 4d 3d + N/2
ComPacT NSX400H (70 kA at 380/415 V)	400 A	C40H34V400	C40H44V400
	570 A	C63H34V570	C63H44V570

Electronic trip unit MicroLogic Vigi 7.3 E (LSIR protection + embedded energy management)

DB438568.ai

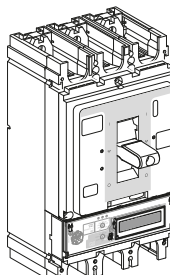

		3P 3d	4P 4d, 3d + N/2
ComPacT NSX400H (36 kA at 380/415V)	400 A	C40H37E400	C40H47E400
	570 A	C63H37E570	C63H47E570

Electronic trip unit MicroLogic 1.3 M (I motor protection)

DB438191.ai

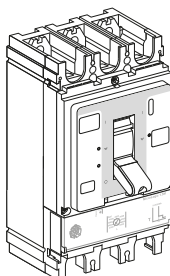

		3P 3d	
ComPacT NSX400H 1.3 M (70 kA at 380/415V)	320 A	C40H31M320	
	500 A	C63H31M500	

Electronic trip unit MicroLogic 2.3 M (LS₀I motor protection)

DB438192.ai

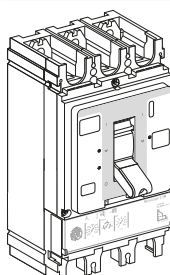

		3P 3d	
ComPacT NSX400H 2.3 M (70 kA at 380/415V)	320 A	C40H32M320	
	500 A	C63H32M500	



Complete Fixed Device

ComPacT NSX400/630R (200 KA 380/415 V - 45 KA 690 V)

ComPacT NSX400/630R

Electronic trip unit MicroLogic 2.3 (LS₀I protection)

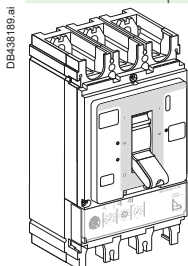

DB438189.ai		NSX400R (200 kA at 380/415 V - 45 kA at 690 V)	250 A	3P 3d	4P 3d, 4d, 3d + N/2
			400 A	C40R32D250	C40R42D250
		NSX630R (200 kA at 380/415 V - 45 kA at 690 V)	630 A	C40R32D400	C40R42D400
				C63R32D630	C63R42D630

Electronic trip unit MicroLogic 5.3 E (LSI protection, energy meter)

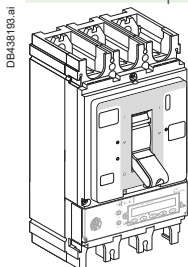

DB438193.ai		NSX400R (200 kA at 380/415 V - 45 kA at 690 V)	400 A	3P 3d	4P 3d, 4d, 3d + N/2, 3d + OSN
		NSX630R (200 kA at 380/415 V - 45 kA at 690 V)	630 A	C40R35E400	C40R45E400
				C63R35E630	C63R45E630

Electronic trip unit MicroLogic 6.3 E (LSIG protection, energy meter)

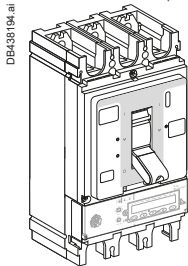

DB438194.ai		NSX400R (200 kA at 380/415 V - 45 kA at 690 V)	400 A	3P 3d	4P 3d, 4d, 3d + N/2, 3d + OSN
		NSX630R (200 kA at 380/415 V - 45 kA at 690 V)	630 A	C40R36E400	C40R46E400
				C63R36E630	C63R46E630

Electronic trip unit MicroLogic 1.3 M (I motor protection)

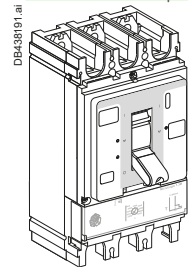

DB438191.ai		NSX400R (200 kA at 380/415 V - 45 kA at 690 V)	320 A	3P 3d	
		NSX630R (200 kA at 380/415 V - 45 kA at 690 V)	500 A	C40R31M320	
				C63R31M500	

Electronic trip unit MicroLogic 2.3 M (LS₀I motor protection)

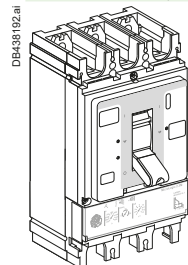

DB438192.ai		NSX400R (200 kA at 380/415 V - 45 kA at 690 V)	320 A	3P 3d	
		NSX630R (200 kA at 380/415 V - 45 kA at 690 V)	500 A	C40R32M320	
				C63R32M500	

With electronic trip unit MicroLogic 6.3 E-M (LSIG motor protection, energy meter)

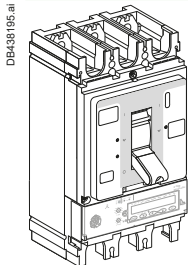

DB438195.ai		NSX400R (200 kA at 380/415 V - 45 kA at 690 V)	320 A	3P 3d	
		NSX630R (200 kA at 380/415 V - 45 kA at 690 V)	500 A	C40R36M320	
				C63R36M500	

F

Complete Fixed Device

ComPacT NSX400/630HB1 (85 KA 500 V - 75 KA 690 V)

ComPacT NSX400/630HB1

Electronic trip unit MicroLogic 2.3 (LS₀I protection)

DB438189.ai

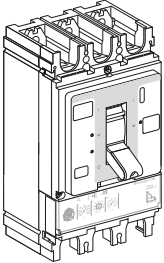

NSX400HB1 (85 kA at 500 V - 75 kA at 690 V)	250 A	3P 3d C40V32D250	4P 3d, 4d, 3d + N/2 C40V42D250
	400 A	C40V32D400	C40V42D400
NSX630HB1 (85 kA at 500 V - 75 kA at 690 V)	630 A	C63V32D630	C63V42D630

Electronic trip unit MicroLogic 5.3 E (LSI protection, energy meter)

DB438193.ai

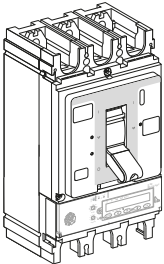

NSX400HB1 (85 kA at 500 V - 75 kA at 690 V)	400 A	3P 3d C40V35E400	4P 3d, 4d, 3d + N/2, 3d + OSN C40V45E400
NSX630HB1 (85 kA at 500 V - 75 kA at 690 V)	630 A	C63V35E630	C63V45E630

Electronic trip unit MicroLogic 6.3 E (LSIG protection, energy meter)

DB438194.ai

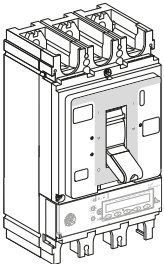

NSX400HB1 (85 kA at 500 V - 75 kA at 690 V)	400 A	3P 3d C40V36E400	4P 3d, 4d, 3d + N/2, 3d + OSN C40V46E400
NSX630HB1 (85 kA at 500 V - 75 kA at 690 V)	630 A	C63V36E630	C63V46E630

Electronic trip unit MicroLogic 1.3 M (I motor protection)

DB438191.ai

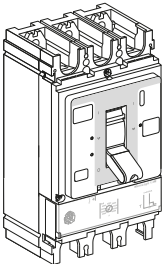

NSX400HB1 (85 kA at 500 V - 75 kA at 690 V)	320 A	3P 3d C40V31M320	
NSX630HB1 (85 kA at 500 V - 75 kA at 690 V)	500 A	C63V31M500	

Electronic trip unit MicroLogic 2.3 M (LS₀I motor protection)

DB438192.ai

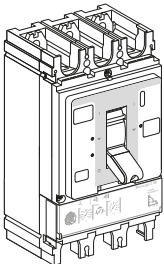

NSX400HB1 (85 kA at 500 V - 75 kA at 690 V)	320 A	3P 3d C40V32M320	
NSX630HB1 (85 kA at 500 V - 75 kA at 690 V)	500 A	C63V32M500	

With electronic trip unit MicroLogic 6.3 E-M (LSIG motor protection, energy meter)

DB438195.ai

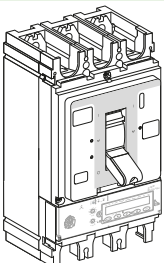

NSX400HB1 (85 kA at 500 V - 75 kA at 690 V)	320 A	3P 3d C40V36M320	
NSX630HB1 (85 kA at 500 V - 75 kA at 690 V)	500 A	C63V36M500	

Complete Fixed Device

ComPacT NSX400/630HB2 (85 KA 500 V - 100 KA 690 V)

ComPacT NSX400/630HB2

Electronic trip unit MicroLogic 2.3 (LS₀I protection)

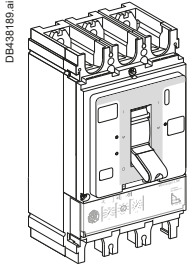

DB438189.ai

NSX400HB2 (85 kA at 500 V - 100 kA at 690 V)	250 A	3P 3d	4P 3d, 4d, 3d + N/2
	400 A	C40W32D250	C40W42D250
NSX630HB2 (85 kA at 500 V - 100 kA at 690 V)	630 A	C40W32D400	C40W42D400
		C63W32D630	C63W42D630

Electronic trip unit MicroLogic 5.3 E (LSI protection, energy meter)

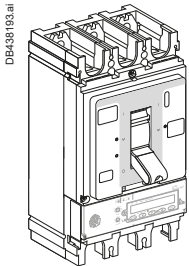

DB438193.ai

NSX400HB2 (85 kA at 500 V - 100 kA at 690 V)	400 A	3P 3d	4P 3d, 4d, 3d + N/2, 3d + OSN
		C40W35E400	C40W45E400
NSX630HB2 (85 kA at 500 V - 100 kA at 690 V)	630 A	C63W35E630	C63W45E630

Electronic trip unit MicroLogic 6.3 E (LSIG protection, energy meter)

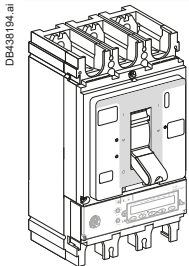

DB438194.ai

NSX400HB2 (85 kA at 500 V - 100 kA at 690 V)	400 A	3P 3d	4P 3d, 4d, 3d + N/2, 3d + OSN
		C40W36E400	C40W46E400
NSX630HB2 (85 kA at 500 V - 100 kA at 690 V)	630 A	C63W36E630	C63W46E630

Electronic trip unit MicroLogic 1.3 M (I motor protection)

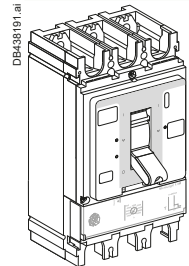

DB438191.ai

NSX400HB2 (85 kA at 500 V - 100 kA at 690 V)	320 A	3P 3d	
		C40W31M320	
NSX630HB2 (85 kA at 500 V - 100 kA at 690 V)	500 A	C63W31M500	

Electronic trip unit MicroLogic 2.3 M (LS₀I motor protection)

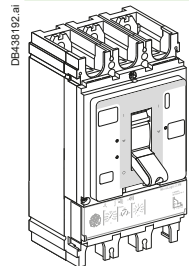

DB438192.ai

NSX400HB2 (85 kA at 500 V - 100 kA at 690 V)	320 A	3P 3d	
		C40W32M320	
NSX630HB2 (85 kA at 500 V - 100 kA at 690 V)	500 A	C63W32M500	

With electronic trip unit MicroLogic 6.3 E-M (LSIG motor protection, energy meter)

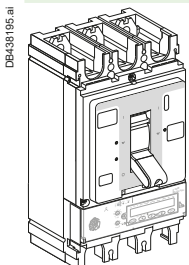

DB438195.ai

NSX400HB2 (85 kA at 500 V - 100 kA at 690 V)	320 A	3P 3d	
		C40W36M320	
NSX630HB2 (85 kA at 500 V - 100 kA at 690 V)	500 A	C63W36M500	

F

Complete Fixed Device

ComPacT NSX400/630NA

ComPacT NSX400K (10 KA - 1000V AC)

ComPacT NSX400K [1]

Special application

DE-430026.ai

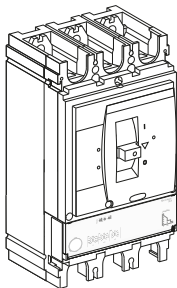

	3P	4P
ComPacT NSX400K, 250 A, MicroLogic 2.3	C40K32D250	C40K42D250
ComPacT NSX400K, 400 A, MicroLogic 2.3	C40K32D400	C40K42D400

ComPacT NSX400/630 NA Switch-Disconnecter

With NA switch-disconnector unit

DE-431196.ai

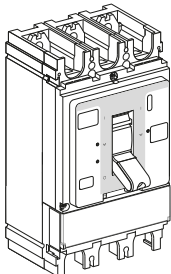

	3P	4P
ComPacT NSX400 NA	C403400S	C404400S
ComPacT NSX630 NA, 45 mm pitch	C633630S	C634630S

[1] Long or short terminal shields are mandatory.



Based on Separate Components

ComPacT NSX400/630

Basic Frame

DB438197.ai

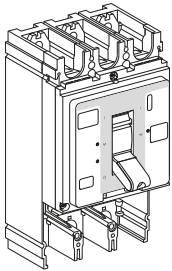

ComPacT NSX400

NSX400F (36 kA 380/415 V)	3P	4P
NSX400N (50 kA 380/415 V)	C40F3	C40F4
NSX400H (70 kA 380/415 V)	C40N3	C40N4
NSX400S (100 kA 380/415 V)	C40H3	C40H4
NSX400L (150 kA 380/415 V)	C40S3	C40S4
	C40L3	C40L4

ComPacT NSX630

NSX630F (36 kA 380/415 V)	3P	4P
NSX630N (50 kA 380/415 V)	C63F3	C63F4
NSX630H (70 kA 380/415 V)	C63N3	C63N4
NSX630S (100 kA 380/415 V)	C63H3	C63H4
NSX630L (150 kA 380/415 V)	C63S3	C63S4
	C63L3	C63L4

+ Trip Unit

Distribution protection

DB111461.eps

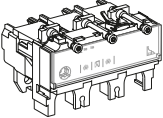

MicroLogic 2.3 (LS_oI protection)

Rating	3P 3d	4P 3d, 4d, 3d + N/2
MicroLogic 2.3 250 A	C4032D250	C4042D250
MicroLogic 2.3 400 A	C4032D400	C4042D400
MicroLogic 2.3 630 A	C6332D630	C6342D630

DB111462.eps

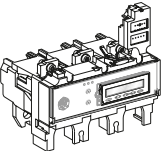

MicroLogic 5.3 E (LSI protection, energy meter)

Rating	3P 3d	4P 3d, 4d, 3d + N/2, 3d + OSN
MicroLogic 5.3 E 400 A	C4035E400	C4045E400
MicroLogic 5.3 E 630 A	C6335E630	C6345E630

DB111462.eps

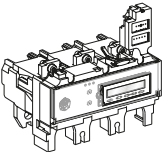

MicroLogic 6.3 E (LSIG protection, energy meter)

Rating	3P 3d	4P 3d, 4d, 3d + N/2, 3d + OSN
MicroLogic 6.3 E 400 A	C4036E400	C4046E400
MicroLogic 6.3 E 630 A	C6336E630	C6346E630

Distribution protection with embedded earth leakage protection

DB425917.eps

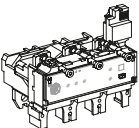

With electronic trip unit MicroLogic Vigi 4.3 (LS_oIR protection)

Rating	3P 3d	4P 4d 3d + N/2
400 A	C4034V400	C4044V400
570 A	C6334V570	C6344V570

DB425919.eps

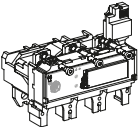

With electronic trip unit MicroLogic Vigi 7.3 E (LSIR protection)

Rating	3P 3d	4P 4d 3d + N/2
400 A	C4037E400	C4047E400
570 A	C6337E570	C6347E570

Distribution protection with embedded earth leakage protection alarm

DB425918.eps

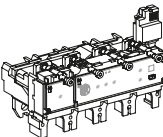

With electronic trip unit MicroLogic Vigi 4.3 AL (LS_oI protection + earth leakage alarm)

Rating	3P 3d	4P 4d 3d + N/2
400 A	C4034A400	C4044A400
570 A	C6334A570	C6344A570

DB425920.eps

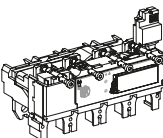

With electronic trip unit MicroLogic Vigi 7.3 E AL (LSI protection + earth leakage alarm)

Rating	3P 3d	4P 4d 3d + N/2
400 A	C4037A400	C4047A400
570 A	C6337A570	C6347A570

Based on Separate Components

ComPacT NSX400/630

+ Trip Unit

Motor protection

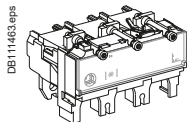

MicroLogic 1.3 M (I protection)

Rating	3P 3d	4P 3d
MicroLogic 1.3 M 320 A	C4031M320	C4041M320
MicroLogic 1.3 M 500 A	C6331M500	C6341M500

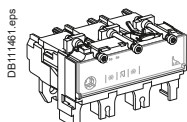

MicroLogic 2.3 M (LS₀I protection)

Rating	3P 3d
MicroLogic 2.3 M 320 A	C4032M320
MicroLogic 2.3 M 500 A	C6332M500

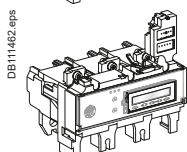

MicroLogic 6.3 E-M (LSIG protection, energy meter)

Rating	3P 3d
MicroLogic 6.3 E-M 320 A	C4036M320
MicroLogic 6.3 E-M 500 A	C6336M500

Protection of public distribution systems

MicroLogic 2.3 AB (LS₀I protection)

Rating	4P 3d, 4d, 3d + N/2
MicroLogic 2.3 400 A	C4042B400

16 Hz 2/3 network protection

MicroLogic 5.3 A-Z (LSI protection, ammeter)

Rating	3P 3d
MicroLogic 5.3 A-Z 630 A	C6335Z630

Earth Leakage protection of public distribution systems

MicroLogic Vigi 4.3 AB distribution protections

Rating	4P 4d 3d + N/2
400 A	C4044B400

+ VigiPacT Add-on Protection and Alarm Modules

VigiPacT add-on protection

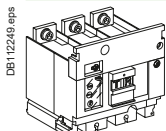

200 to 440 V	3P	4P
440 to 550 V	LV432464	LV432465
Connection for a 4P VigiPacT on a 3P breaker	LV432466	LV432467
		LV432457

VigiPacT add-on alarm

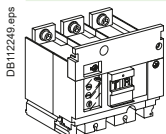



200 to 440 V	3P	4P
Connection for a 4P insulation monitoring module on a 3P breaker	LV432469	LV432470
		LV432457



Trip Unit Accessories

ComPacT NSX400/630

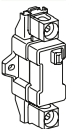
Trip Unit Accessories

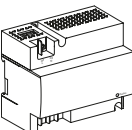
	External neutral CT for 3 pole breaker with MicroLogic 5/6 400-630 A	LV432575
	24 V DC wiring accessory for MicroLogic 5/6 24 Vdc Terminal Block and SD Auxiliary Contact for BSCM Modbus SL/ULP	LV434210
	ZSI accessory for NS630b-NW with NSX ZSI module	LV434212
	Micrologic power supply (24 V DC - 1 A), OVC IV	LV454440
	24-30 V DC	LV454441
	48-60 V DC	LV454442
	100-125 V DC	LV454443
	110-130 V AC	LV454444
200-240 V AC	LV454444	

Installation and Connection

ComPacT NSX400/630

Fixed/RC Device = Fixed/FC Device + Rear Connection Kit

Mixed RC kit

DB438198.ai

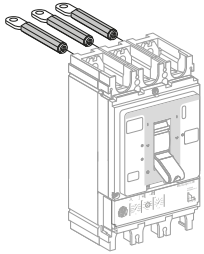

Kit 3P	Short RCs	2 x	LV432475	
	Long RCs	1 x	LV432476	
	Kit 4P	Short RCs	2 x	LV432475
		Long RCs	2 x	LV432476

Plug-in Version = Fixed/FC Device + Plug-in Kit

Kit for ComPacT NSX

DB438199.ai

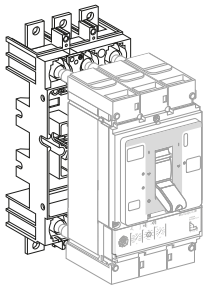

	3P	4P
Plug-in kit	LV432538	LV432539
Comprising:		
Base	= 1 x LV432516	= 1 x LV432517
Power connections	+ 3 x LV432518	+ 4 x LV432518
Short terminal shields	+ 2 x LV432591	+ 2 x LV432592
Safety trip interlock	+ 1 x LV432520	+ 1 x LV432520

Kit for ComPacT NSX VigiPacT Add-on

Kit for ComPacT NSX

	3P	4P
ComPacT NSX Vigi add-on plug-in kit	LV432540	LV432541
Comprising:		
Base	= 1 x LV432516	= 1 x LV432517
Power connections	+ 3 x LV432519	+ 4 x LV432519
Short terminal shields	+ 2 x LV432591	+ 2 x LV432592
Safety trip interlock	+ 1 x LV432520	+ 1 x LV432520

Withdrawable Version = Fixed/FC Device + Withdrawable Kit

Kit for ComPacT NSX

DB43220.ai

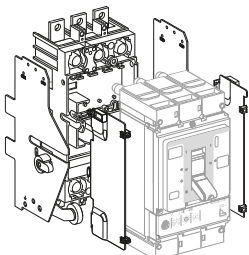

	3P	4P
	Kit for ComPacT NSX	Kit for ComPacT NSX
	=	=
Plug-in kit:	1 x LV432538	1 x LV432539
	+	+
Chassis side plates for base	1 x LV432532	1 x LV432532
	+	+
Chassis side plates for breaker	1 x LV432533	1 x LV432533

Kit for ComPacT NSX Vigi add-on

DB41774.eps

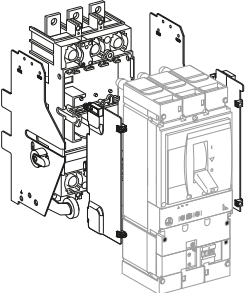









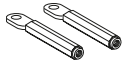

	3P	4P
	Kit for ComPacT NSX Vigi add-on	Kit for ComPacT NSX Vigi add-on
	=	=
Plug-in kit:	1 x LV432540	1 x LV432541
	+	+
Chassis side plates for base	1 x LV432532	1 x LV432532
	+	+
Chassis side plates for breaker	1 x LV432533	1 x LV432533

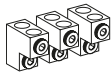

Accessories and Auxiliaries

ComPacT NSX400/630

Connection Accessories (Cu or Al)

Rear connections				
DB11471.eps 	2 short			LV432475
	2 long			LV432476
Bare cable connectors ^[1]				
DB115624.eps 	Aluminium connectors	1 x (35 to 300 mm ²)	Set of 3	LV432479
			Set of 4	LV432480
DB115625.eps 	Aluminium connectors for 2 cables	2 x (35 to 240 mm ²)	Set of 3	LV432481
			Set of 4	LV432482
DB115724.eps 	6.35 mm voltage tap for aluminium connectors for 1 or 2 cables		Set of 10	LV429348
Terminal extensions ^[1]				
DB115649.eps 	45° terminal extensions		Set of 3	LV432586
			Set of 4	LV432587
DB115650.eps 	Edgewise terminal extensions		Set of 3	LV432486
			Set of 4	LV432487
DB115651.eps 	Right-angle terminal extensions		Set of 3	LV432484
			Set of 4	LV432485
DB115652.eps 	Spreaders	52.5 mm	3P	LV432490
			4P	LV432491
		70 mm	3P	LV432492
			4P	LV432493
Crimp lugs for copper cable ^[1]				
DB112377.eps 	For cable 240 mm ²		Set of 3	LV432500
			Set of 4	LV432501
	For cable 300 mm ²		Set of 3	LV432502
			Set of 4	LV432503
Crimp lugs for aluminium cable ^[1]				
DB112338.eps 	For cable 240 mm ²		Set of 3	LV432504
			Set of 4	LV432505
	For cable 300 mm ²		Set of 3	LV432506
			Set of 4	LV432507
Supplied with 2 or 3 interphase barriers				

[1] Supplied with 2 or 3 interphase barriers.

Insulation accessories

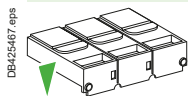

Short terminal shield, 45 mm (1 piece)

3P	LV432591
4P	LV432592

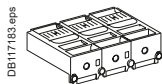

Short terminal shield > 500 V (1 piece)

3P	LV433693
----	----------

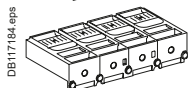

4P	LV433694
----	----------

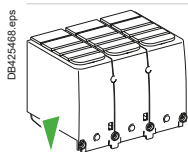

Long terminal shield, 45 mm (1 piece)

3P	LV432593
4P	LV432594

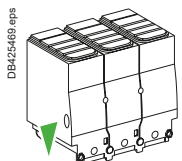

Long terminal shield for spreaders, 52.5 mm (1 piece) (supplied with insulating plate)

3P	LV432595
4P	LV432596

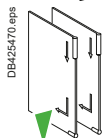

Interphase barriers

Set of 6	LV432570
----------	----------

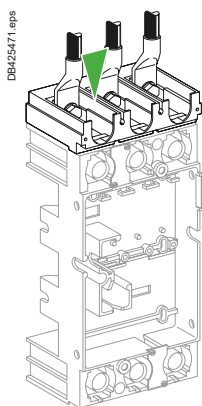

Connection adapter for plug-in base

3P	LV432584
4P	LV432585

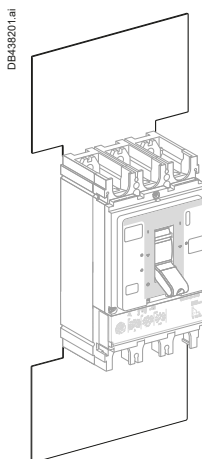

2 insulating screens (70 mm pitch)

3P	LV432578
4P	LV432579



Accessories and Auxiliaries

ComPacT NSX400/630

Electrical Auxiliaries

Auxiliary contacts (screwless, screw)

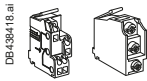

OF or SD or SDE or SDV ^[1] screwless type	29450
OF or SD or SDE or SDV ^[1] screw type	29452

Wireless indication auxiliary



OF or SD or SDE wireless	LV429454
--------------------------	----------

SDx output module for MicroLogic electronic trip unit

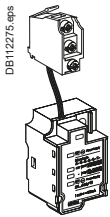

SDx module 24/415 V AC/DC screw type	LV429532
--------------------------------------	----------

SDTAM contactor tripping module (early-break thermal fault signal) for MicroLogic 2.3 M/6.3 E-M

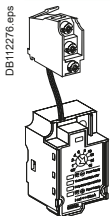

SDTAM 24/415 V AC/DC overload fault indication	LV429424
--	----------

Voltage releases

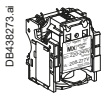

	Voltage	MX	MN
AC	24 V 50/60 Hz	LV429384	LV429404
	48 V 50/60 Hz	LV429385	LV429405
	110-130 V 50/60 Hz	LV429386	LV429406
	220-240 V 50/60 Hz and 208-277 V 60 Hz	LV429387	LV429407
	380-415 V 50 Hz and 440-480 V 60 Hz	LV429388	LV429408
	525 V 50 Hz and 600 V 60 Hz	LV429389	LV429409
DC	12 V	LV429382	LV429402
	24 V	LV429390	LV429410
	30 V	LV429391	LV429411
	48 V	LV429392	LV429412
	60 V	LV429383	LV429403
	125 V	LV429393	LV429413
	250 V	LV429394	LV429414
	MN 48 V 50/60 Hz with fixed time delay		
Composed of:	MN 48 V DC		LV429412
	Delay unit 48 V 50/60 Hz		LV429426
MN 220-240 V 50/60 Hz with fixed time delay			
Composed of:	MN 250 V DC		LV429414
	Delay unit 220-240 V 50/60 Hz		LV429427
MN 48 V DC/AC 50/60 Hz with adjustable time delay			
Composed of:	MN 48 V DC		LV429412
	Delay unit 48 V DC/AC 50/60 Hz		33680
MN 110-130 V DC/AC 50/60 Hz with adjustable time delay			
Composed of:	MN 125 V DC		LV429413
	Delay unit 100-130 V DC/AC 50/60 Hz		33681
MN 220-250 V DC/AC 50/60 Hz with adjustable time delay			
Composed of:	MN 250 V DC		LV429414
	Delay unit 200-250 V DC/AC 50-60 Hz		33682

[1] Only when using a VigiPacT Add-on block adapted to the complete device.

F

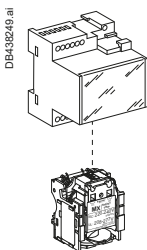

Motor Mechanism

Motor mechanism module

DB111475 eps

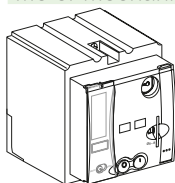

	Voltage	MT400-630
AC	48-60 V 50/60 Hz	LV432639
	110-130 V 50/60 Hz	LV432640
	220-240 V 50/60 Hz and 208-277 V 60 Hz	LV432641
	380-415 V 50 Hz	LV432642
	440-480 V 60 Hz	LV432647
DC	24-30 V	LV432643
	48-60 V	LV432644
	110-130 V	LV432645
	250 V	LV432646
Operation counter		LV432648

Communicating motor mechanism module

DB446946 eps

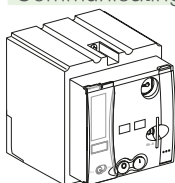

Motor mechanism module	MTc 400/630	220-240 V 50/60 Hz	LV432652
------------------------	-------------	--------------------	----------

+

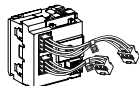

Breaker status Communication Module	ComPacT NSX BSCM Modbus SL/UPL	LV434220
	ComPacT NSX Com Modbus SL Cord 0.35 m	LV434221
	ComPacT NSX Com Modbus SL Cord 1.3 m	LV434222
	ComPacT NSX Com Modbus SL Cord 3 m	LV434223
	Modbus SL Hub	LV434224

+



NSX cord	Wire length L = 0.35 m	LV434200
	Wire length L = 1.3 m	LV434201
	Wire length L = 3 m	LV434202
	U > 480 V AC wire length L = 1.3 m	LV434204

Indication and Measurement Modules

PowerLogic PowerTag NSX

DB4430747 eps

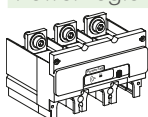

Rating (A)	630
3P	LV434022
3P+N	LV434023

Current transformer module and voltage output

DB117178 eps

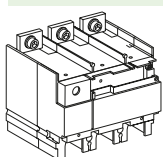

Rating (A)	400	600
3P	LV432653	LV432861
4P	LV432654	LV432862



Accessories and Auxiliaries

ComPacT NSX400/630

Rotary Handles

Direct rotary handle

DB439011.ai

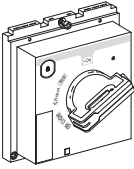

With black handle	LV432597T
With red handle on yellow front	LV432599T
MCC conversion accessory	LV432606T
CNOMO conversion accessory	LV432602T

Extended rotary handle

DB439012.ai

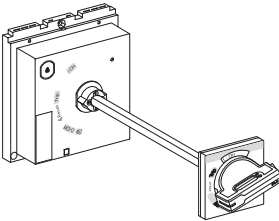

With black handle	LV432598T
With red handle on yellow front	LV432600T
With telescopic handle for withdrawable device	LV432603T

DB421688.eps



Open door shaft operator	LV426937
--------------------------	----------

Accessories for direct or extended rotary handle

Indication auxiliary	1 early-break contact	LV432605
	2 early-make contacts	LV429346

Locks

Toggle locking device for 1 to 3 padlocks

DB43204.ai

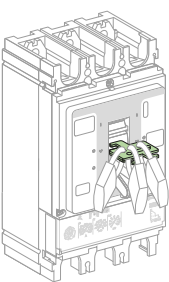

By removable device	29370
---------------------	-------

DB43205.ai

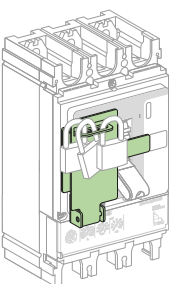

By fixed device for 3P, 4P (open or close position)	LV432631
By fixed device for 3P, 4P (for open position only)	LV432630

Locking of rotary handle

DB439013.ai

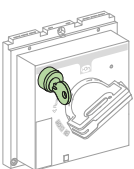

Keylock adapter (keylock not included)	LV432604	
Keylock (keylock adapter not included)	Ronis 1351B.500	41940
	Profalux KS5 B24 D4Z	42888

Locking of motor mechanism module

DB42575.eps

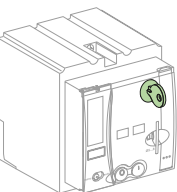

Keylock adapter (keylock not included)	LV432649	
Keylock (keylock adapter not included)	Ronis 1351B.500	41940
	Profalux KS5 B24 D4Z	42888

Interlocking

Mechanical interlocking for circuit breakers

DB438419.ai		With toggles	LV432614T
	DB439014.ai		With direct rotary handle
			With extended rotary handle

Interlocking with key (2 keylocks/1 key) for rotary handles

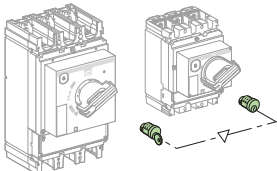
DB439210.ai		Keylock kit (keylock not included) ^[1]	LV432604
		1 set of 2 keylocks	Ronis 1351B.500
		(1 key only, keylock kit not included)	Profalux KS5 B24 D4Z
			42878

Installation Accessories

Front-panel escutcheons

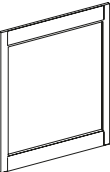
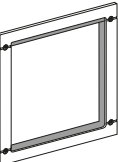
DB111488.eps		IP30 escutcheon for all control types	LV432557
		IP30 trip unit access escutcheon for toggle	LV432559
		IP30 escutcheon for VigiPacT add-on	LV429527
	IP30		
DB111489.eps		IP40 escutcheon for all control types	LV432558
		IP40 escutcheon for VigiPacT add-on	LV429316
		IP40 escutcheon for VigiPacT add-on or ammeter module	LV429318
	IP40		

IP43 rubber toggle cover

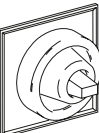
DB111490.eps		1 toggle cover	LV432560 ^[2]
--------------	---	----------------	-------------------------

Lead-sealing accessories

DB115615.eps		Bag of accessories	LV429375
--------------	---	--------------------	----------

60 Mm Plate

DB43207.ai		Plate 3P ComPacT NSX400/630 IEC	LV432623
		Plate 4P ComPacT NSX400/630 IEC	LV432624











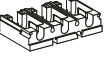

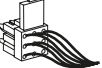
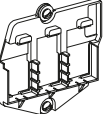
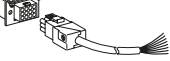
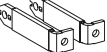
^[1] For only 1 device.

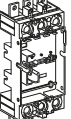
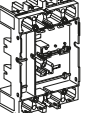
^[2] Need to order LV432553T, toggle extension to be compatible for IP43 rubber cover.

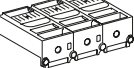
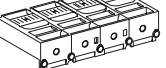
Accessories and Auxiliaries

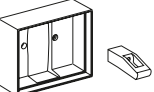
ComPacT NSX400/630

Plug-in/Withdrawable Version Accessories

Insulation accessories			
	Connection adapter for plug-in base	3P	LV432584
		4P	LV432585
Auxiliary connections			
	1 9-wire fixed connector (for base)		LV429273
	1 9-wire moving connector (for circuit breaker)		LV432523
	1 support for 3 moving connectors		LV432525
	9-wire manual auxiliary connector (fixed + moving)		LV429272
Plug-in base accessories			
	Long insulated right angle terminal extensions	Set of 2	LV432526
	2 IP40 shutters for base		LV432521
	Base	3P	LV432516
	Base	4P	LV432517
	Power connections	3/4P	LV432518
	Short terminal shields	3P	LV432591
	Short terminal shield > 500 V (1 piece)	3P	LV433693
	Short terminal shields	4P	LV432592
	Short terminal shield > 500 V (1 piece)	4P	LV433694
	Safety trip interlock	3/4P	LV432520
Chassis accessories			
	Escutcheon collar	Toggle	LV432534 ^[1]
	Escutcheon collar	VigiPacT add-on	LV429285
	Locking kit (keylock not included)		LV429286
	Keylock (keylock adapter not included)	Ronis 1351B.500	41940
		Profalux KS5 B24 D4Z	42888
	2 carriage switches (connected/disconnected position indication)		LV429287







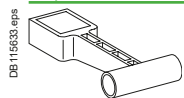

F

[1] Need to order LV434436, NSX front cover to be compatible for escutcheon collar for toggle.

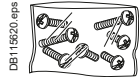
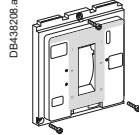
Accessories and Auxiliaries

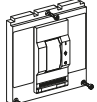
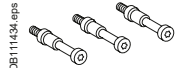
ComPacT NSX400/630

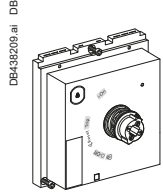
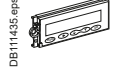
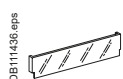
Spare Parts

	Additional toggle extension for NSX400/630		32595 ^[1]
	10 spare toggle extensions		LV432553T
	Bag of screws		LV432552
	NSX400-630 front cover	3P/4P	LV434436
	Retrofit NSX400-630 front cover (F/N/H)	3P/4P	LV4344ALT
	NSX400-630 front cover (R/HB1/HB2)	3P/4P	LV4344AHT
	IP40 toggle escutcheon	ComPacT NS type/small cut-out	32556
	ComPacT NS retrofit escutcheon	Small cut-out	LV432571
	Torque limiting screws (set of 12)	3P/4P ComPacT NSX400-630	LV432513
	1 set of 10 identification labels		LV429226
	1 base for extended rotary handle		LV432498T
	LCD display for electronic trip unit	MicroLogic 5 MicroLogic 6 MicroLogic 6 E-M MicroLogic 7	LV429483 LV429484 LV429486 LV429485
	5 transparent covers for electronic trip unit	MicroLogic 5/6 MicroLogic 2	LV432459 LV432461
	ULP cable (set of 15)	MicroLogic 7	LV429471
	ENVT kit	MicroLogic 5/6	LV429470

Visible Break Disconnect Function

See catalog dealing with "ComPacT INV products (visible break)" and the associated accessories.
The visible break disconnection function is compatible with fixed front-connected/rear-connected ComPacT NSX devices.

[1] Need to order LV432553T, NSX front cover to be compatible for escutcheon collar for toggle.



Communication, Monitoring and Control

ComPacT NSX400/630

Communication Option

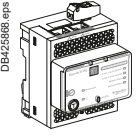
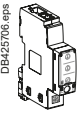
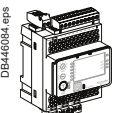
	IFE	Ethernet interface for LV breakers and gateway	LV434002
	IFM Modbus-SL interface module		LV434000
	I/O application module		LV434063

Monitoring and Control (Remote Operation)

Circuit breaker accessories

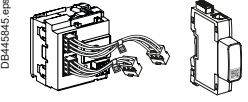
	Breaker Status Control Module	ComPacT NSX BSCM Modbus SL/ULP ^[1]	LV434220
		ComPacT NSX Com Modbus SL Cord 0.35 m	LV434221
		ComPacT NSX Com Modbus SL Cord 1.3 m	LV434222
		ComPacT NSX Com Modbus SL Cord 3 m	LV434223
		Modbus SL Hub	LV434224



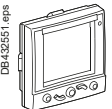



ULP display module^[2]

	Switchboard front display module FDM121	TRV00121
	FDM mounting accessory (diameter 22 mm)	TRV00128

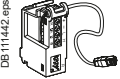
Ethernet display module

	Switchboard front display module FDM128	LV434128
--	---	----------

ULP wiring accessories

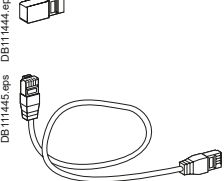
	NSX cord L = 0.35 m	LV434200
	NSX cord L = 1.3 m	LV434201
	NSX cord L = 3 m	LV434202
	NSX cord for U > 480 V AC L = 1.3 m	LV434204
	10 stacking connectors for communication interface modules	TRV00217
	2 Modbus line terminators used with screw connection	VW3A8306DRC
	Modbus line terminators used with RJ45 connections	VW3A8306RC
	Connector Modbus adaptor	LV434211
	RS 485 roll cable (4 wires, length 60 m)	50965
	5 RJ45 connectors female/female	TRV00870
	10 ULP line terminators	TRV00880
	10 RJ45/RJ45 male cord L = 0.3 m	TRV00803
	10 RJ45/RJ45 male cord L = 0.6 m	TRV00806
	5 RJ45/RJ45 male cord L = 1 m	TRV00810
	5 RJ45/RJ45 male cord L = 2 m	TRV00820
	5 RJ45/RJ45 male cord L = 3 m	TRV00830
	1 RJ45/RJ45 male cord L = 5 m	TRV00850

[1] SDE adapter mandatory for trip unit TM, MA or MicroLogic 2 (LV429451).

[2] For measurement display with MicroLogic E or status display with BSCM Modbus SL/ULP.

Monitoring and Control, Accessories

ComPacT NSX400/630

Accessories

Power supply modules

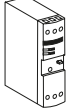
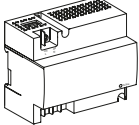
DB112276.eps 	External power supply module 100-240 V AC 110-230 V DC/24 V DC-3 A class 2	ABL8RPS24030
DB432026.eps 	Micrologic power supply 24 V DC-1 A OVC IV	
	24-30 V DC	LV454440
	48-60 V DC	LV454441
	100-125 V DC	LV454442
	110-130 V AC	LV454443
200-240 V AC	LV454444	

Test Tool, Software, Demo

Test tool

DB111446.eps 	Pocket battery for MicroLogic NSX100-630	LV434206
---	--	-----------------

Mini test kit

DB126163.eps 	Hand held test kit (HHTK)	33594
---	---------------------------	--------------

Service Interface Test Kit

DB439317.ai 	BTM (Breaker Test Module)	LV485500
	Service interface spare part	LV485510SP
	Service interface AC/DC power	LV485511SP
	Service interface 7 pin cable ACB MCCB TU	LV485512SP
	Service interface ULP cable	LV485514SP
	Service interface USB magnet cable	LV485517SP

DB111448.eps 	Bluetooth/Modbus option for USB maintenance interface	VW3A8114
---	---	-----------------

Source-Changeover Systems for 2 Devices

ComPacT NSX100 to NSX630

Manual Source-Changeover

Mechanical interlocking

DB41858B.ai

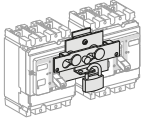

For toggle controlled circuit breakers
NSX100...250
NSX400...630

LV429354T
LV432614T

DB41858B.eps

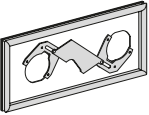

For rotary handled circuit breakers
NSX100...250
NSX400...630

LV429369T
LV432621T

Interlocking on base plate

DB41858C12.ai

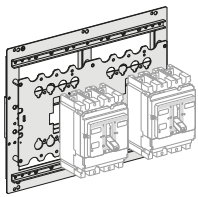

For 2 devices side by side

29349
32609

Keylock interlocking

DB41858D10.ai

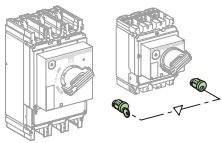

For rotary handled or remote controlled circuit breakers
2 locks, 1 key
Ronis 1351B.500
Profalux KS5 B24 D4Z

41950
42878

Connection Accessories

Downstream coupling accessories

DB101062.eps

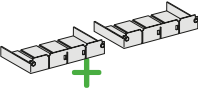

Short terminal shields (1 pair) + "S1" source/"S2" source

	3P	4P
NSX100...250/NSX100...250/ 250 A	LV429358	LV429359
NSX400...630/NSX400...630/ 630 A	LV432619	LV432620

DB413273.eps

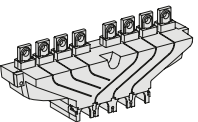

Long terminal shields (1 pair)

NSX100...250/NSX100...250		LV429518
NSX400...630/NSX400...630		LV432594
Long terminal shield for spreaders, 52.5 mm (1 piece)	LV432596	LV432596

DB403821.eps

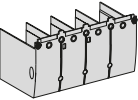

Terminal Extensions

DB115852.eps



Spreaders 52.5 mm 4P **LV432491**

F

Source-Changeover Systems for 2 Devices

ComPacT NSX100 to NSX630

Typical Composition of Source-Changeover System

Remote source-changeover

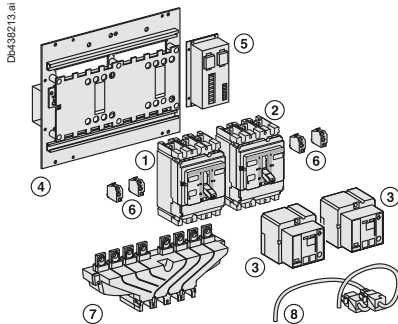

- 1 normal device N (1)
- + 1 replacement device R (2)
- + 2 remote controls (3)
- + 1 plate with interlocking (4) with IVE (5) and its wiring (8)
- + 2 plug-in kits (if plug-in version)
- + 1 adaptor kit for NSX100...250 plug-in (if NSX400...630 with NSX100...250)
- + auxiliary switches (6)
- 2 x (1 OF + 1 SDE) for ComPacT NSX100...630
- + 1 downstream coupling accessory (7) for ComPacT NSX100...630 (option)
- + long RC (if back connection)

IVE and remote controls must have the same voltage.

Associated controller

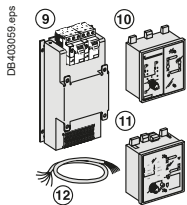

- 1 source changeover without associated controller
- + 1 ACP (9) with BA controller (10)
- Or + 1 ACP (9) with UA controller (11)
- Or + 1 ACP (9) with UA150 controller (11)
- + extension (12) for remote UA/BA connection on front of switchboard

IVE + remote control + ACP + BA or UA must have the same voltage.

Automatic Source-Changeover

Mechanical and electrical interlocking

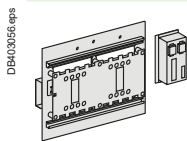

Source "normal"/source "replacement" (identical voltages)	24 to 250 V DC	48 to 415 V AC 50/60 Hz 440 V 60 Hz
NSX100...250/NSX100...250		
Plate + IVE	29351	29350
Plate	29349	29349
IVE	29356	29352
Auxiliary switches 2 OF + 2 SDE	4 x 29450	4 x 29450
Spare wiring system (device/IVE)	29365	29365
Back sockets option add: Only long RC	[2]	[2]
Plug in base option add: Plug in kit	[2]	[2]
NSX400...630/NSX100...630		
Plate + IVE	32611	32610
Plate	32609	32609
IVE	29356	29352
Auxiliary switches 2 OF + 2 SDE	4 x 29450	4 x 29450
Spare wiring system (device/IVE)	29365	29365
Back sockets option add: Only long RC	[2]	[2]
Plug in base option add: Plug in kit	[2]	[2]
Adaptator kit for NSX100...250	1 x 32618	1 x 32618

Controller

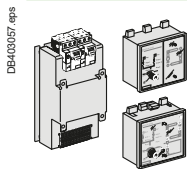

	110/127 V AC 50/60 Hz	220/240 V AC 50/60 Hz	380/415 V AC 50/60 Hz 440 V 60 Hz
ACP + controller BA [1]		29470	29471
Plate ACP		29363	29364
Controller BA		29376	29377
ACP + controller UA [1]	29448	29472	29473
Plate ACP	29447	29363	29364
Controller UA	29446	29378	29380

Wiring cable between BA/UA and ACP/IVE

Wiring cable (1.5 meter)	29368	29368
--------------------------	--------------	--------------

[1] The supply voltages BA/UA controller, ACP plate, IVE and the remote control must be identical whatever the source-changeover type.
 [2] See products pages.

Source-Changeover Systems for 2 Devices

ComPacT NSX100 to NSX630

Controller with Adaptor



Controller, TransferPacT UC, 230V, 230V MCH, NSX NS MTZ 100-6300 A	TUC2BMS051D02E
Controller, TransferPacT UC, 440V, 440V MCH, NSX NS MTZ 100-6300 A	TUC2BMS052D02E
Controller, TransferPacT UC, 440V, 230V MCH, NSX NS MTZ 100-6300 A	TUC2BMS053D02E

Accessories



Load Shedding and Availability Warning	TPCDIO05
Genset Start and Alarm	TPCDIO06
Transfer Inhibit and Remote Testing	TPCDIO07
Voluntary Remote Control	TPCDIO08
24 VDC Auxiliary Supply	TPCDIO15
Modbus RTU (Serial Port)	TPCCOM76
Source Status output	TPCDIO19



IK07 Surface Cover	TPCOTH75
--------------------	-----------------



Bracket	TPCOTH77
---------	-----------------

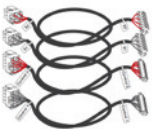

Harness 0.5m	TPCOTH78
--------------	-----------------



Harness 2m	TPCOTH79
------------	-----------------



Harness 2.5m (Voltage sampling cable for NSX 250)	TPCOTH87
---	-----------------



Harness 2.5m (Voltage sampling cable for NSX 630, NS1600, MTZ1,2,3)	TPCOTH88
---	-----------------



Harness (Connect two NSX devices and adaptor) Note: a set of 29356 only contained one S1 or S2 cable. 2 sets of 29356 must be selected to build ATSE control system. Note: Do not need to select harness again if backplate 29439 for NSX 100-250A or 32609 for NSX 320-630A has been selected because 29365 was already included.	29365
--	--------------



Harness (Connect two NS, MTZ1,2,3 devices and adaptor) Note: a set of 54655 has contained two of cables (for S1+S2 connection). 1 set of 54655 must be selected to build ATSE control system.	54655
--	--------------

Spare Parts

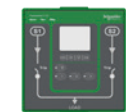

UC controller - 230 V	SPKTPCOTH80
UC controller - 440 V for 380V MCH	SPKTPCOTH83
UC controller - 440 V or 220 V MCH	SPKTPCOTH85



UC adaptor 230 V input + 220 V MCH	SPKTPCOTH81
UC adaptor 440 V input + 380 V MCH	SPKTPCOTH82
UC adaptor 440 V input + 220 V MCH	SPKTPCOTH84

Catalog Numbers NSX100/400 Utilities, "Tarif Jaune" Public Distribution

Complete Fixed/FC Device without Accessories

ComPacT NSX with MicroLogic AB

DB438106.ai

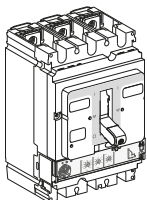

ComPacT NSX

Comprising of:	Rating	Basic frame	MicroLogic AB
NSX100F + MicroLogic AB 100 A	100 A	C10F4	C1042B100
NSX160F + MicroLogic AB 160 A	160 A	C16F4	C1642B160
NSX250F + MicroLogic AB 240 A	240 A	C25F4	C2542B240
NSX400F + MicroLogic AB 400 A	400 A	C40F4	C4042B400

ComPacT NSX with MicroLogic AB + VigiPacT Add-on

ComPacT NSX VigiPacT Add-on

Comprising of:	Rating	4P Basic frame	MicroLogic AB	VigiPacT Add-on
NSX100F + MicroLogic AB 100 A + VigiPacT Add-on	100 A	C10F4	C1042B100	LV429489
NSX160F + MicroLogic AB 160 A + VigiPacT Add-on	160 A	C16F4	C1642B160	LV429489
NSX250F + MicroLogic AB 240 A + VigiPacT Add-on	240 A	C25F4	C2542B240	LV429493
NSX400F + MicroLogic AB 400 A + VigiPacT Add-on	400 A	C40F4	C4042B400	LV432465

ComPacT NSX with TMD

DB438105.ai

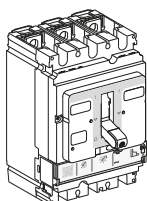

ComPacT NSX100F

	Rating	4P 3d	4P 4d
TM40D	40 A	C10F6TM040	C10F4TM040
TM63D	63 A	C10F6TM063	C10F4TM063
TM80D	80 A	C10F6TM080	C10F4TM080
TM100D	100 A	C10F6TM100	C10F4TM100

ComPacT NSX160F

	Rating	4P 3d	4P 4d
TM40D	40 A	C16F6TM080	C16F4TM080
TM63D	63 A	C16F6TM100	C16F4TM100
TM80D	80 A	C16F6TM125	C16F4TM125
TM100D	100 A	C16F6TM160	C16F4TM160

ComPacT NSX250F

	Rating	4P 3d	4P 4d
TM40D	40 A	C25F6TM125	C25F4TM125
TM63D	63 A	C25F6TM160	C25F4TM160
TM80D	80 A	C25F6TM200	C25F4TM200
TM100D	100 A	C25F6TM250	C25F4TM250

ComPacT NSX with MicroLogic 2.3

ComPacT NSX400F

	Rating	4P 3d, 4d, 3d + N/2
NSX400F + MicroLogic 2.3		C40F42D400



Catalog Numbers

NSX100/400 for Utilities, "Tarif Jaune" Public Distribution Visible Break

ComPacT INV100 to INV630 Standard Version

DB438673.ai

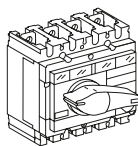

ComPacT INV100	For ComPacT NSX100	4P
ComPacT INV160	For ComPacT NSX160	31161
ComPacT INV200	For ComPacT NSX250	31165
ComPacT INV250	For ComPacT NSX250	31163
		31167

DB438674.ai

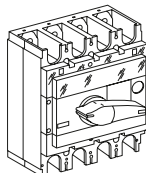

ComPacT INV320	For ComPacT NSX400	4P
ComPacT INV400	For ComPacT NSX400	31169
		31171

Spare Viewport

DB438675.ai

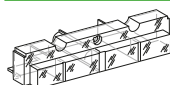

For INV100 to 250	31089
For INV320/400	31090

Combination with ComPacT NSX Devices

DB438676.ai

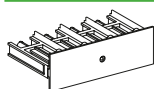

INV100 to 250 - NSX250 combination assembly	31066
INV320/400 - NSX250 combination assembly	31067
Front alignment base for INV320/400 - NSX250 combination assembly	31064
INV320/400 - NSX400 combination assembly	31068

DB438676.eps

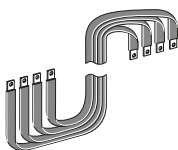

Flexible connection assembly for vertical INV100 to 250 with NSX horizontal N ^[1]	04443
Flexible connection assembly for vertical INV100 to 250 with NSX horizontal V ^[1]	04444
Flexible connection assembly for vertical INV320 to 630 with NSX horizontal N ^[1]	04445
Flexible connection assembly for vertical INV320 to 630 with NSX horizontal V ^[1]	04446
Flexible connection assembly for vertical INV100 to 250 with vertical NSX250 beside	31071
Flexible connection assembly for vertical INV320 to 630 with vertical NSX400/630 beside	31072
Flexible connection assembly for vertical INV320 to 630 with vertical NSX250 beside	31093

[1] Product sold by MGA and valid for new Prisma only.

NSX100/400 for Utilities, "Tarif Jaune" Public Distribution

Installation and Connection with or without the Visible Break Function

Conventional installation

Combination assembly

Upstream and downstream connection

INV100 to 250 - NSX100/160/250	4 snap-on bare cable connectors for cables:	1.5 to 95 mm ² ; ≤ 160 A	2x	LV429243
		10 to 185 mm ² ; ≤ 250 A	2x	LV429260
	10 clips for bare cable connector		1x	LV429241
	4 right-angle terminal extensions		2x	LV429262
	2 long terminal shields		1x	LV429518
INV320/400 - NSX100/160/250	4 bare cable connectors:	For 1 cable, 35 mm ² to 300 mm ²	1x	LV432480
		For 2 cables, 35 mm ² to 240 mm ²	1x	LV432482
	4 right-angle terminal extensions		1x	LV432485
	1 long terminal shield		1x	LV432594
	4 snap-on bare cable connectors for cables:	1.5 to 95 mm ² ; ≤ 160 A	1x	LV429243
	10 to 185 mm ² ; ≤ 250 A	1x	LV429260	
	10 clips for bare cable connector		1x	LV429241
	4 right-angle terminal extensions		1x	LV429262
	1 long terminal shield		1x	LV429518
INV320/400 - NSX400	4 bare cable connectors:	For 1 cable, 35 mm ² to 300 mm ²	2x	LV432480
		For 2 cables, 35 mm ² to 240 mm ²	2x	LV432482
	4 right-angle terminal extensions		2x	LV432485
	1 long terminal shield		1x	LV432594

Installation in cabinet or enclosure

Combination assembly (mounting in duct)

Flexible connection assembly (mounting in cubicle)

Upstream and downstream connection

INV100 to 250 - NSX100/160/250	4 snap-on bare cable connectors for cables:	1.5 to 95 mm ² ; ≤ 160 A	2x	LV429243
		10 to 185 mm ² ; ≤ 250 A	2x	LV429260
	1 short terminal shield		1x	LV429516
INV320/400 - NSX100/160/250	4 bare cable connectors:	For 1 cable, 35 mm ² to 300 mm ²	1x	LV432480
		For 2 cables, 35 mm ² to 240 mm ²	1x	LV432482
	1 short terminal shield		1x	LV432592
	4 snap-on bare cable connectors for cables:	1.5 to 95 mm ² ; ≤ 160 A	1x	LV429243
		10 to 185 mm ² ; ≤ 250 A	1x	LV429260
	1 short terminal shield		1x	LV429516
INV320/400 - NSX400	4 bare cable connectors:	For 1 cable, 35 mm ² to 300 mm ²	2x	LV432480
		For 2 cables, 35 mm ² to 240 mm ²	2x	LV432482
	1 short terminal shield		1x	LV432592

ComPacT NSX100 to NSX630 Order Form

Name of customer:
 Address for delivery:

Requested delivery date:
 Customer order no.:

To indicate your choices, check the applicable square boxes
 or note the quantity

and enter the appropriate information in the rectangles

Circuit breaker or switch-disconnector

ComPacT type **NSX100/160/250 - 160A not available with R, HB1 or HB2 NSX400/630**

Rating **A**

Circuit breaker **B, F, N, H, S, L, R, HB1, HB2**

Switch-disconnector **NA**

Number of poles **1, 2, 3 or 4**

Number of poles **2d, 3d or 4d**

protected

Fixed device Front connections

Plug-in/withdr. Plug-in Withdrawable

Earth-leakage protection **ME, MH, MB (not available with R, HB1 or HB2)**

Trip unit

Thermal-mag. TMD rating (16 ... 250 A) (40 ... 250 A) with R, HB1 and (63 ... 250 A) with HB2

TMG rating (16 ... 250 A) - not available with R, HB1 or HB2

MA rating (2.5 ... 220 A) (12.5 ... 220 A) with R, HB1 and HB2

Electronic MicroLogic 2.2

* Not available with R, HB1 or HB2 MicroLogic 2.2 G*

MicroLogic 2.2 AB*

MicroLogic Vigi 4.2

MicroLogic Vigi 4.2 AL

MicroLogic Vigi 4.2 AB

MicroLogic 5.2 A*

MicroLogic 5.2 E

MicroLogic 5.2 A-Z*

MicroLogic 6.2 A*

MicroLogic 6.2 E

MicroLogic Vigi 7.2 E

MicroLogic Vigi 7.2 AL

MicroLogic 2.2 M

MicroLogic 6.2 E-M

SDTAM Module

MicroLogic 2.3

MicroLogic 2.3 AB*

MicroLogic Vigi 4.3

MicroLogic Vigi 4.3 AL

MicroLogic Vigi 4.3 AB

MicroLogic 5.3 A*

MicroLogic 5.3 E

MicroLogic 5.3 A-Z*

MicroLogic 6.3 A*

MicroLogic 6.3 E

MicroLogic Vigi 7.3 E

MicroLogic Vigi 7.3 EAL

MicroLogic 1.3 M

MicroLogic 2.3 M

MicroLogic 6.3 E-M

External neutral CT

24 V DC power supply connector

ZSI connector accessory for plug-in and withdrawable

ZSI wiring accessory for NS630b/MTZ

External power supply module 24 V DC

24-30 V DC 48-60 V DC

100-125 V AC 110-130 V AC

200-240 V AC

Battery module

Connection

Rear-connection kit Short Long Mixed

NSX100/250 connectors Snap-on 1.5[□] to 95[□] (< 160 A)

Snap-on 25[□] to 95[□] (< 250 A)

Snap-on 120[□] to 185[□] (< 250 A)

Distribution 6 x 1.5[□] to 35[□]

Aluminium 1 cable 25 to 95

Aluminium 1 cable 120 to 185

Aluminium 1 cable 120 to 250

Aluminium 2 cables 50[□] to 120[□]

NSX400/630 connectors 1 cable 35[□] to 300[□]

2 cables 35[□] to 240[□]

Right-angle terminal extensions

Straight extensions NSX100/250

Edgewise extensions 45° terminal extension Double-L terminal extensions

Spreader NSX100/250 (one piece) (45 mm)

NSX400/630 (52.5 mm) (70 mm)

Cu cable lugs NSX100/250 120[□] 150[□] 185[□]

NSX400/630 240[□] 300[□]

Al cable lugs NSX100/250 150[□] 185[□]

NSX400/630 240[□] 300[□]

Voltage measurement For lugs NSX100/250 ≤ 185[□]

Input for connector For lugs NSX400/630

Terminal shields NSX100/250 Short Long

NSX400/630 Short Long

Short ≥ 500 V Long for 52.5 mm spreaders

Interphase barriers Set of 6

2 insulating screens: NSX100/250

NSX400/630 70 pitch

Test tool

Pocket battery for MicroLogic Power supply 110-240 V AC

Maintenance case Spare MicroLogic cord

USB maintenance interface

Indication and measurement

PowerLogic PowerTag NSX 3P 4P

Current-transformer module + TCU 3P 4P

Insulation-monitoring module - not available with HB1 or HB2 3P 4P

Voltage-presence indicator - not available with HB1 or HB2

Auxiliary contact OF, SD, SDE or SDV Screwless Screw

OF, SD, SDE Wireless

SDE adapter (TM, MA or MicroLogic 2 trip units)

SDX module

Remote operation

Electrical operation Motor mechanism AC DC V

Instantaneous MX AC DC V

MN AC DC V

Fixed time delay MN AC DC V

Adjust. time delay MN AC DC V

Rotary handles

Direct Black Red and yellow front

MCC conversion access. CNOMO conversion access.

Extended Black Red and yellow front

Telescopic handle for withdrawable device

Open door shaft operator

Indication auxiliary 1 early-break switch 2 early-make switches

Locking

Toggle (1 to 3 padlocks) Removable Fixed

Rotary handle Keylock adapter (keylock not included)

Keylocks Ronis 1351B.500 Profalux KS5 B24 D4Z

Motor mechanism Keylock adapter + keylock Ronis (special)

Keylocks Ronis 1351B.500 NSX100/250

Keylock adapter (keylock not included) NSX400/630

Keylocks Ronis 1351B.500 Profalux KS5 B24 D4Z

Interlocking

Mechanical Toggle operated Rotary Handle

By key (2 keylocks, 1 key) Locking kit without locks

for rotary handle Keylocks Ronis 1351B.500 Profalux KS5 B24 D4Z

Installation accessories

IP30 escutcheon for all types (toggle/rotary handle/motor mechanism)

IP30 escutcheon (with access to toggle + trip unit)

IP30 escutcheon for VigiPacT add-on

IP40 escutcheon for all types (toggle/rotary handle/motor mechanism)

IP40 escutcheon for VigiPacT add-on

IP40 escutcheon for VigiPacT add-on or ammeter module

Toggle cover

Sealing accessories

DIN rail adapter NSX100/250

3P 60 mm busbar adapter

Plug-in/withdrawable configuration accessories

Auxiliary connections 1 automatic connector fixed part with 9 wires (for base)

1 automatic connector moving part with 9 wires (for circuit breaker)

1 support for 3 automatic connector 1 support for 2

moving parts automatic connector

9-wire manual auxiliary connector (fixed + moving)

Plug-in base accessories Long insulated terminals Set of 2

2 IP4 shutters for base

Chassis accessories Escutcheon collar Toggle Vigi

Locking kit (keylock not included)

2 carriage switches (conn./disconnected position indication)

Parts or plug-in Plug-in base FC/RC 2P 3P 4P

Withdrawable kits Set of two power connections Standard Vigi

Safety trip for advanced opening

For 3P/4P chassis Moving part

Fixed part

Adapter for plug-in base (for terminal shield or interphase barriers)

Communication

NSX Cord L = 0.35 m NSX Cord L = 1.3 m

NSX Cord U > 480 V AC L = 1.3 m NSX Cord L = 3 m

BSCM Modbus SL/ULP

ComPacT NSX Com Modbus SL Cord 0.35 m

ComPacT NSX Com Modbus SL Cord 1.3 m

ComPacT NSX Com Modbus SL Cord 3 m

Modbus SL Hub

Communicating motor mechanism 220-240 V

Switchboard front display module FDM121

FDM mounting accessory

Ethernet Interface + Gateway

Ethernet Interface

Modbus interface

I/O Application Module Qty 1

Qty 2

Stacking accessory

ULP line termination

RJ45 connectors female/female Wire length RJ45 Wire length RJ45

L = 0.3 m L = 0.6 m

Wire length RJ45 Wire length RJ45

L = 1 m L = 2 m

Wire length RJ45 Wire length RJ45

L = 3 m L = 5 m

Glossary

Accessories.....	G-2
Circuit-Breaker Characteristics (IEC 60947-2).....	G-2
Communication.....	G-4
Components.....	G-6
Controls.....	G-6
Selectivity/Cascading.....	G-6
Environment.....	G-7
Harmonics.....	G-8
Measurements.....	G-9
Protection.....	G-10
Relays and Auxiliary Contacts.....	G-10
Switchgear.....	G-11
Three-Phase Asynchronous Motors and Their Protection.....	G-11
Trip Units.....	G-12



Other Chapters	
Select Circuit Breakers and Switch-Disconnectors.....	A-1
Select Protection.....	B-1
Customize Circuit Breakers with Accessories.....	C-1
Smart Panel Integration.....	D-1
Switchboard Integration.....	E-1
Catalog Numbers.....	F-1
Additional Characteristics.....	H-1

Glossary

For each major section (Accessories, Switchgear, etc.) and for each item (Adapter for plug-in base, Connection terminal, etc.), this glossary provides:

- The page number in the concerned catalog
- The reference standard
- The standardized IEC symbol
- The definition.

Text in quotation marks is drawn from the standards.

Accessories

Adapter for plug-in base	The adapter is a plastic component that can be installed upstream and/or downstream of the plug-in base and enables use of all the connection accessories of the fixed device.
Bare-cable connector	Conducting part of the circuit breaker intended for connection to power circuits. On ComPacT NSX, it is an aluminium part that screws to the connection terminals of the circuit breaker. There are one or more holes (single or multiple cable connector) for the ends of bare cables.
Connection terminals	Flat copper surface, linked to the conducting parts of the circuit breaker and to which power connections are made using bars, connectors or lugs.
One-piece spreader	The spreader is a plastic component with copper connectors that can be installed upstream and/or downstream of a ComPacT NSX100 to 250 circuit breaker with a pole pitch of 35 mm. It increases the pitch of the circuit-breaker terminals to the 45 mm pitch of a NSX400/630 device to facilitate connection of large cables.
Spreaders	Set of three (3P device) or four (4P) flat, conducting parts made of aluminium. They are screwed to the circuit-breaker terminals to increase the pitch between poles.

Circuit-breaker characteristics (IEC 60947-2)

Breaking capacity	Value of prospective current that a switching device is capable of breaking at a stated voltage under prescribed conditions of use and behaviour. Reference is generally made to the ultimate breaking capacity (Icu) and the service breaking capacity (Ics).
Degree of protection (IP) IEC 60529	<p>Defines device protection against the penetration of solid objects and liquids, using two digits specified in standard IEC 60529. Each digit corresponds to a level of protection, where 0 indicates no protection.</p> <ul style="list-style-type: none"> ■ First digit (0 to 6): protection against penetration of solid foreign objects. 1 corresponds to protection against objects with a diameter > 50 mm, 6 corresponds to total protection against dust. ■ Second digit (0 to 8): protection against penetration of liquids (water). 1 corresponds to protection against falling drops of water (condensation), 8 corresponds to continuous immersion. <p>The enclosure of ComPacT NSX circuit breakers provides a minimum of IP40 (protection against objects > 1 mm) and can reach IP56 (protection against dust and powerful water jets) depending on the installation conditions.</p>
Degree of protection against external mechanical impacts (IK)	<p>Defines the aptitude of an object to resist mechanical impacts on all sides, indicated by a number from 0 to 10 (standard IEC 62262). Each number corresponds to the impact energy (in Joules) that the object can handle according to a Standardized procedure.</p> <p>0 corresponds to no protection, 1 to an impact energy of 0.14 Joules, 10 to an impact energy of 20 Joules. ComPacT NSX provide IK07 (2 Joules) and can provide IK08 (5 Joules) depending on the installation conditions.</p>
Durability	The term "durability" is used in the standards instead of "endurance" to express the expectancy of the number of operating cycles which can be performed by the equipment before repair or replacement of parts. The term "endurance" is used for specifically defined operational performance.
Electrical durability IEC 60947-1	With respect to its resistance to electrical wear, equipment is characterized by the number of on-load operating cycles, corresponding to the service conditions given in the relevant product standard, which can be made without replacement.



Frame size	<p>A term designating a group of circuit breakers, the external physical dimensions of which are common to a range of current ratings. Frame size is expressed in amperes corresponding to the highest current rating of the group. Within a frame size, the width may vary according to the number of poles. This definition does not imply dimensional standardization.</p> <p>ComPacT NSX has two frame sizes covering 100 to 250 A and 400 to 630 A.</p>
Insulation class	<p>Defines the type of device insulation in terms of earthing and the corresponding safety for user, in one of three classes.</p> <ul style="list-style-type: none"> ■ Class I. The device is earthed. Any electrical faults, internal or external, or caused by the load, are cleared via the earthing circuit, thus ensuring user safety. ■ Class II. The device is not connected to a protective conductor. User safety is ensured by reinforced insulation around the live parts (an insulating case and no contact with live parts, i.e. plastic buttons, molded connections, etc.) or double insulation. ■ Class III. The device may be connected only to SELV (safety extra-low voltage) circuits. The ComPacT NSX are class II devices (front) and may be installed through the door in class II switchboards (standards IEC 61140 and IEC 60664-1), without reducing insulation, even with a rotary handle or motor mechanism module.
Making capacity	<p>Value of prospective making current that a switching device is capable of making at a stated voltage under prescribed conditions of use and behaviour. Reference is generally made to the short-circuit making capacity I_{cm}.</p>
Maximum break time	<p>Maximum time after which breaking is effective, i.e. the contacts separated and the current completely interrupted.</p>
Mechanical durability	<p>With respect to its resistance to mechanical wear, equipment is characterized by the number of no-load operating cycles which can be effected before it becomes necessary to service or replace any mechanical parts.</p>
Non-tripping time	<p>This is the minimum time during which the protective device does not operate in spite of pick-up overrun, if the duration of the overrun does not exceed the corresponding voluntary time delay.</p>
Pollution degree of environment conditions IEC 60947-1 IEC 60664-1	<p>Conventional number based on the amount of conductive or hygroscopic dust, ionized gas or salt and on the relative humidity and its frequency of occurrence, resulting in hygroscopic absorption or condensation of moisture leading to reduction in dielectric strength and/or surface resistivity. Standard IEC 60947-1 distinguishes four pollution degrees.</p> <ul style="list-style-type: none"> ■ Degree 1. No pollution or only dry, non-conductive pollution occurs. ■ Degree 2. Normally, only non-conductive pollution occurs. Occasionally, however, a temporary conductivity caused by condensation may be expected. ■ Degree 3. Conductive pollution occurs, or dry, non-conductive pollution occurs which becomes conductive due to condensation. ■ Degree 4. The pollution generates persistent conductivity caused, for instance, by conductive dust or by rain or snow. ComPacT NSX meets degree 3, which corresponds to industrial applications.
Prospective short-circuit current	<p>Current that would flow through the poles if they remained fully closed during the short-circuit.</p>
Rated current (In)	<p>This is the current that the device can carry continuously with the contacts closed and without abnormal temperature rise.</p>
Rated impulse withstand voltage (Uimp)	<p>The peak value of an impulse voltage of prescribed form and polarity which the equipment is capable of withstanding without failure under specified conditions of test and to which the values of the clearances are referred. The rated impulse withstand voltage of an equipment shall be equal to or higher than the values stated for the transient overvoltages occurring in the circuit in which the equipment is fitted.</p>
Rated insulation voltage (Ui)	<p>The rated insulation voltage of an equipment is the value of voltage to which dielectric tests and creepage distances are referred. In no case shall the maximum value of the rated operational voltage exceed that of the rated insulation voltage.</p>
Rated operational current (Ie)	<p>A rated operational current of an equipment is stated by the manufacturer and takes into account the rated operational voltage, the rated frequency, the rated duty, the utilization category and the type of protective enclosure, if appropriate.</p>
Rated operational voltage (Ue)	<p>A value of voltage which, combined with a rated operational current, determines the application of the equipment and to which the relevant tests and the utilization categories are referred. For multipole equipment, it is generally stated as the voltage between phases.</p> <p>This is the maximum continuous voltage at which the equipment may be used.</p>

Glossary

Rated short-time withstand current (Icw)	Value of short-time withstand current, assigned to the equipment by the manufacturer, that the equipment can carry without damage, under the test conditions specified in the relevant product standard. Generally expressed in kA for 0.5, 1 or 3 seconds. This is an essential characteristic for air circuit breakers. It is not significant for molded-case circuit breakers for which the design targets fast opening and high limiting capacity.
Service breaking capacity (Ics)	Expressed as a percentage of Icu, it provides an indication on the robustness of the device under severe conditions. It is confirmed by a test with one opening and one closing/opening at Ics, followed by a check that the device operates correctly at its rated current, i.e. 50 cycles at In, where temperature rise remains within tolerances and the protection system suffers no damage.
Short-circuit making capacity (Icm)	Value indicating the capacity of the device to make and carry a high current without repulsion of the contacts. It is expressed in kA peak.
Suitability for isolation (see also below Positive contact indication)	<p>This capability means that the circuit breaker meets the conditions below.</p> <ul style="list-style-type: none"> ■ In the open position, it must withstand, without flashover between the upstream and downstream contacts, the impulse voltage specified by the standard as a function of the Uimp indicated on the device. ■ It must indicate contact position by one or more of the following systems: <ul style="list-style-type: none"> □ Position of the operating handle □ Separate mechanical indicator □ Visible break of the moving contacts ■ Leakage current between each pole, with the contacts open, at a test voltage of 1.1 x the rated operating voltage, must not exceed: <ul style="list-style-type: none"> □ 0.5 mA per pole for new devices □ 2 mA per pole for devices already subjected to normal switching operations □ 6 mA, the maximum value that must never be exceeded. ■ It must not be possible to install padlocks unless the contacts are open. Locking in the closed position is permissible for special applications. ComPacT NSX complies with this requirement by positive contact indication.
Suitable for isolation with positive contact indication (see also above Suitability for isolation)	<p>Suitability for isolation is defined here by the mechanical reliability of the position indicator of the operating mechanism, where:</p> <ul style="list-style-type: none"> ■ The isolation position corresponds to the O (OFF) position ■ The operating handle cannot indicate the "OFF" position unless the contacts are effectively open. <p>The other conditions for isolation must all be fulfilled:</p> <ul style="list-style-type: none"> ■ Locking in the open position is possible only if the contacts are effectively open ■ Leakage currents are below the Standardized limits ■ Overvoltage impulse withstand between upstream and downstream connections.
Ultimate breaking capacity (Icu)	Expressed in kA, it indicates the maximum breaking capacity of the circuit breaker. It is confirmed by a test with one opening and one closing/opening at Icu, followed by a check that the circuit is properly isolated. This test ensures user safety.

Communication.....



BSCM Modbus SL/ULP (Breaker status and control module)	The optional BSCM Modbus SL/ULP for ComPacT NSX is used to acquire device status indications and control the communicating remote-control function. It includes a memory used to manage the maintenance indicators. It serves as a converter between the analog outputs of the device indication contacts (O/F, SD, SDE) and the digital communicating functions.
Ethernet TCP/IP (Transmission Control Protocol/Internet Protocol)	Ethernet is a very common network protocol and complies with IEEE standard 802.3. Ethernet TCP/IP is the protocol that brings web functions to Ethernet networks. Most PCs have an Ethernet 10/100 card (10 or 100 Mbit/s) for connection to the internet. Data communicated from ComPacT NSX via Modbus are accessible on a PC via a TCP/IP-Modbus gateway such as PAS400/600/800.
FDM121 switchboard display	An FDM121 switchboard display unit can be connected to a ULP IMU using a prefabricated cord to display all measurements, alarms, histories and event tables, maintenance indicators, management of installed devices on a screen. The result is a veritable 96 x 96 mm Power Meter. The FMD121 display unit requires a 24 V DC power supply. The FDM121 is a switchboard display unit that can be integrated in the ComPacT NSX100 to 630 A, PowerPacT H/J/L/P/R, ComPacT NS or MasterPacT systems.
FDM128 switchboard display	The FDM128 is an intelligent Ethernet display. It collects the data from up to 8 devices via Ethernet network. The FDM128 is a large display, but requires very little depth. The anti-glare graphic screen is backlit for very easy reading even under poor ambient lighting and at sharp angles.

IFE Ethernet interface, IFE Ethernet interface + gateway	The IFE Ethernet interface for LV circuit breaker enables an intelligent modular unit (IMU), for example a MasterPacT NT/NW/MTZ or ComPacT NSX circuit breaker to be connected to an Ethernet network.
IFM Module interface Modbus	This module required for connection to the network, contains the Modbus address (1 to 99) declared by the user via the two dials in front. It automatically adapts (baud rate, parity) to the Modbus network in which it is installed. It is equipped with a lock-out switch to enable or disable operations involving writing to MicroLogic, i.e. reset, counter reset, setting modifications, device opening and closing commands, etc. There is a built-in test function to check the connections of the Modbus interface module with the MicroLogic and FDM121 display unit.
I/O application module	The I/O (Input/Output) application module for LV breaker is part of an ULP system with built-in functionalities and applications to enhance the application needs. The ULP system architecture can be built without any restrictions using the wide range of circuit breakers. The I/O application module is compliant with the ULP system specifications. Two I/O application modules can be connected in the same ULP network.
Network	Set of communicating devices that are interconnected by communication lines in order to share data and resources.
Open protocol	A protocol for system communication, interconnection or data exchange for which technical specifications are public, i.e. there are no restrictions on access or implementation. An open protocol is the opposite of a proprietary protocol.
Protocol	Standardized specification for dialog between digital components that exchange data. It is an operating mode based on the length and structure of binary words and it must be used by all the components exchanging data between themselves. Communication is not possible without using a protocol.
RJ45 connector	Universal, 8-wire connector that is widely used in digital communication networks. The RJ45 connector is used to interconnect computer equipment (Ethernet, Modbus, etc.), telephones and audiovisual equipment.
RS485 Modbus	Modbus is the most widely used communication protocol in industrial networks. It operates in master-slave mode. An RS485 multipoint link connects the master and slaves via a pair of wires offering throughputs of up to 38400 bits/second over distances up to 1200 m). The master cyclically polls the slaves which send back the requested information. The Modbus protocol uses frames containing the address of the targeted slave, the function (read, write), the datum and the CRC (cyclical redundancy check).
SDTAM	Relay module with two static outputs specifically for the motor-protection MicroLogic trip units 1 M, 2 M and 6 E-M. An output, linked to the contactor controller, opens the contactor when an overload or other motor fault occurs, thus avoiding opening of the circuit breaker. The other output stores the opening event in memory.
SDx	Relay module with two outputs that remotes the trip or alarm conditions of ComPacT NSX circuit breakers equipped with a MicroLogic electronic trip unit.
I/O Smart Link	I/O Smart Link is used to transfer data from devices to a PLC or monitoring system via the communication system: Modbus serial line.
Static output	Output of a relay made up of a thyristor or triac electronic component. The low switching capability means that a power relay is required. This is the case for the SDx and SDTAM outputs.
ULP (Universal Logic Plug) 	Connection system used by ComPacT NSX to communicate information to the Modbus interface via a simple RJ45 cable. Compatible modules are indicated by the symbol opposite.

Glossary

Components

ASIC (Application Specific Integrated Circuit)

Integrated circuit designed, built and intended for a specific application. It carries out repetitive sequences of instructions engraved in the silicon chip. For that reason, it is extremely reliable because it cannot be modified and is not affected by environment conditions.

MicroLogic trip units use an ASIC for the protection functions. The ASIC cyclically polls the network status at a high frequency, using the values supplied by captors. Comparison with the settings forms the basis for orders to the electronic trip units.

Microprocessor

A microprocessor is a more general purpose device than an ASIC. In MicroLogic, a microprocessor is used for measurements and it can be programmed. It is not used for the main protection functions that are carried out by the ASIC.

Controls

Communicating motor mechanism

For ComPacT NSX remote control via the communication system, a communicating motor mechanism is required. Except for the communication function, it is identical to the standard motor mechanism module and connects to and controlled by the BSCM Modbus SL/ULP module.

CNOMO machine-tool rotary handle

Handle used for machine-tool control enclosures and providing IP54 and IK08.

Direct rotary handle

This is an optional control handle for the circuit breaker. It has the same three positions I (ON), O (OFF) and TRIPPED as the toggle control. It provides IP40, IK07 and the possibility, due to its extended travel, of using early-make and early-break contacts. It maintains suitability for isolation and offers optional locking using a keylock or a padlock.

Emergency off

In a circuit equipped with a circuit breaker, this function is carried out by an opening mechanism using an MN undervoltage release or an MX shunt release in conjunction with an emergency off button.

Extended rotary handle

Rotary handle with an extended shaft to control devices installed at the rear of switchboards. It has the same characteristics as direct rotary handles. It offers multiple locking possibilities using a keylock, a padlock or a door interlock.

Failsafe remote tripping

Remote tripping is carried out by an opening mechanism using an MN undervoltage release in conjunction with an emergency off button. If power is lost, the protection device opens the circuit breaker.

Manual toggle control

This is the standard control mechanism for the circuit breaker, with a toggle that can be flipped up or down. In a molded-case circuit breaker (MCCB), there are three positions, I (ON), O (OFF) and TRIPPED. Once in the TRIPPED position, manual reset is required by switching to O (OFF position before reclosing. The TRIPPED position does not offer isolation with positive contact indication. This is guaranteed only by the O (OFF) position.

MCC rotary handle

Handle used for motor control centres and providing IP43 and IK07.

Motor mechanism module

The optional motor mechanism module is used to remotely open, close and recharge the circuit breaker.

Selectivity/Cascading

Cascading

Cascading implements the current-limiting capacity of a circuit breaker, making it possible to install downstream circuit breakers with lower performance levels. The upstream circuit breaker reduces any high short-circuit currents. This makes it possible to install downstream circuit breakers with breaking capacities less than the prospective short-circuit current at their point of installation. The main advantage of cascading is to reduce the overall cost of switchgear. Because the current is limited throughout the circuit downstream of the limiting circuit breaker, cascading applies to all the devices located downstream.

Current selectivity

Selectivity based on the difference between the current-protection settings of the circuit breakers. The difference in settings between two successive circuit breakers in a circuit must be sufficient to allow the downstream breaker to clear the fault before the upstream breaker trips.

Selectivity	Selectivity is ensured between upstream and downstream circuit breakers if, when a fault occurs, only the circuit breaker placed immediately upstream of the fault trips. Selectivity is the key to ensuring the continuity of service of an installation.
Energy selectivity	This function is specific to ComPacT NSX (see Reflex tripping on page G-7) and supplements the other types of selectivity.
Partial selectivity	Selectivity is partial if the conditions for total selectivity are not met up to the ultimate short-circuit current I_{cu} , but only up to a lesser value. This value is called the selectivity limit. If a fault exceeds the selectivity limit, both circuit breakers trip.
Time selectivity	Selectivity based on the difference between the time-delay settings of the circuit breakers. The upstream trip unit is delayed to provide the downstream breaker the time required to clear the fault.
Total selectivity	Total selectivity is ensured between upstream and downstream circuit breakers if, for all fault values, from overloads up to solid short-circuits, only the downstream circuit breaker trips and the upstream circuit breaker remains closed.
Zone selective interlocking (ZSI)	<p>A number of circuit breakers with MicroLogic electronic trip units are interconnected one after another by a pilot wire. In the event of a short-time or ground fault:</p> <ul style="list-style-type: none"> ■ In the absence of information from downstream, the circuit breaker directly concerned by the fault (i.e. located just upstream of the fault) shifts to the shortest time delay and sends a signal upstream ■ The upstream device, on receiving the signal from the downstream device, maintains its normal time delay. <p>In this manner, the fault is cleared rapidly by the circuit breaker closest to the fault.</p>

Environment.....

EMC (Electromagnetic compatibility)	EMC is the capacity of a device not to disturb its environment during operation (emitted electromagnetic disturbances) and to operate in a disturbed environment (electromagnetic disturbances affecting the device). The standards define various classes for the types of disturbances. MicroLogic trip units comply with annexes F and J in standard IEC IE60947-2.
Power loss Pole resistance	The flow of current through the circuit-breaker poles produces Joule-effect losses caused by the resistance of the poles.
Product environmental profile (PEP) LCA: Life-cycle assessment ISO 14040	<p>An assessment on the impact of the construction and use of a product on the environment, in compliance with standard ISO 14040, Environmental management, life-cycle assessment (LCA), principles and framework.</p> <p>For ComPacT NSX, this assessment is carried out using the Standardized EIME (Environmental Impact and Management Explorer) software, which makes possible comparisons between the products of different manufacturers.</p> <p>It includes all stages, i.e. manufacture, distribution, use and end of life, with set usage assumptions:</p> <ul style="list-style-type: none"> ■ Use over 20 years at a percent load of 80% for 14 hours per day and 20% for ten hours ■ According to the European electrical-energy model. <p>It provides the information presented below.</p> <ul style="list-style-type: none"> ■ Materials making up the product: composition and proportions, with a check to make sure no substances forbidden by the RoHS directive are included. ■ Manufacture: on Schneider Electric production sites that have set up an environmental management system certified ISO 14001. ■ Distribution: packaging in compliance with the 94/62/EC packaging directive (optimized volumes and weights) and optimized distribution flows via local centres. ■ Use: no aspects requiring special precautions for use. Power lost through Joule effect in Watts (W) must be < 0.02% of total power flowing through the circuit breaker. Based on the above assumptions, annual consumption from 95 to 200 kWh. ■ End of life: products dismantled or crushed. For ComPacT NSX, 81% of materials can be recycled using standard recycling techniques. Less than 2% of total weight requires special recycling.



Glossary

<p>Product environmental profile (PEP) Environmental indicators</p>	<p>Environmental indicators are also frequently used for the PEP (sheet available on request for ComPacT NSX):</p> <ul style="list-style-type: none"> ■ Depletion of natural resources ■ Depletion of energy ■ Depletion of water ■ Potential for atmospheric warming (greenhouse effect) ■ Potential for stratospheric ozone depletion ■ Creation of atmospheric ozone (ozone layer) ■ Acidification of air (acid rain) ■ Production of hazardous waste.
<p>RoHS directive (Restriction of Hazardous substances)</p>	<p>European directive 2002/95/EC dated 27 January 2003 aimed at reducing or eliminating the use of hazardous substances. The manufacturer must attest to compliance, without third-party certification. Circuit breakers are not included in the list of concerned products, which are essentially consumer products. That notwithstanding, Schneider Electric decided to comply with the RoHS directive. ComPacT NSX products are designed in compliance with RoHS and do not contain (above the Authorized levels) lead, mercury, cadmium, hexavalent chromium or flame retardants (polybrominated biphenyls PBB and polybrominated diphenyl ether PBDE).</p>
<p>Clearance distances</p>	<p>When installing a circuit breaker, minimum clearance distances must be maintained between the device and panels, bars and other protection systems installed nearby. These distances, which depend on the ultimate breaking capacity, are defined by tests carried out in accordance with standard IEC 60947-2.</p>
<p>Temperature derating</p>	<p>An ambient temperature varying significantly from 40°C can modify operation of magnetic or thermal-magnetic protection functions. It does not affect electronic trip units. However, when electronic trip units are used in high-temperature situations, it is necessary to check the settings to ensure that only the permissible current for the given ambient temperature is let through.</p>
<p>Vibration withstand IEC 60068-2-6</p>	<p>Circuit breakers are tested in compliance with standard IEC 60068-2-6 for the levels required by merchant-marine inspection organizations (Veritas, Lloyd's, etc.):</p> <ul style="list-style-type: none"> ■ 2 to 13.2 Hz: amplitude of ±1 mm ■ 13.2 to 100 Hz: constant acceleration of 0.7 g.
<p>WEEE directive (Waste of Electrical and Electronic Equipment)</p>	<p>European directive on managing the waste of electrical and electronic equipment. Circuit breakers are not included in the list of concerned products. However, ComPacT NSX products respect the WEEE directive.</p>

Harmonics.....



<p>Current harmonics</p>	<p>Non-linear loads cause harmonic currents that flow in the 50 Hz (or 60 Hz) distribution system. Total harmonic current is the sum of sinusoidal AC currents for which the rms values can be measured and broken down into:</p> <ul style="list-style-type: none"> ■ The fundamental current at the 50/60 Hz frequency of the distribution system, with an rms value of I_{H_1} ■ Harmonic currents with whole, odd multiples (3, 5, 7, etc.) of the 50/60 Hz frequency, called the third-order, fifth-order, etc. harmonics. For example, I_{H_3}, the third-order harmonic at 150/180 Hz, I_{H_5}, the fifth-order harmonic at 250/300 Hz, etc. <p>The presence of harmonics in the system must be monitored and limited because it results in temperature rise, currents in the neutral (caused by the third-order harmonics and multiples), malfunctions of sensitive electronic devices, etc. MicroLogic E trip units take into account harmonics up to order 15 in the THDI and THDU calculations.</p>
<p>Non-linear load</p>	<p>Systems producing harmonics are present in all industrial, commercial and residential sectors. Harmonics are caused by non-linear loads. A load is said to be non-linear when the current drawn does not have the same waveform as the supply voltage. Typically, loads using power electronics are non-linear. Examples of non-linear loads include computers, rectifiers, variable-speed drives, arc furnaces and fluorescent lighting.</p>
<p>Total harmonic distortion of current (THDI)</p>	<p>THDI characterizes the distortion of the current wave by harmonics. It indicates the quantity of harmonics in the resulting waveform. It is expressed in percent. The higher the THDI, the more the current is distorted by harmonics. THDI should remain below 10%. Above that level, there is said to be harmonic pollution that is considered severe when it rises above 50%.</p>

Total harmonic distortion of voltage (THDU)	THDU characterizes the distortion of the voltage wave by harmonics. It indicates the quantity of harmonics in the resulting waveform. It is expressed in percent. The higher the THDU, the more the system voltage is distorted by harmonics. It is advised not to exceed 5% for low-voltage systems.
Voltage harmonics	For each current harmonic I_{Hk} , there is a voltage harmonic U_{Hk} of the same order k , where the resulting voltage is the sum of the two waves. The voltage wave is therefore distorted with respect to the standard sinusoidal wave.

Measurements

Contact wear	Each time ComPacT NSX opens, the MicroLogic 5/6 trip unit measures the interrupted current and increments the contact-wear indicator as a function of the interrupted current, according to test results stored in memory.
Current transformer with Rogowski toroid or air-core CT	It is made up of a coil without an iron frame, through which a power busbar runs. The output voltage at the coil terminals is proportional to the current flowing through the bar. The result is a current transformer (CT) with a voltage output. The advantage is that it never saturates whatever the primary current and thus enables measurement of high currents. The output is however a very low current that is too low to supply the measurement electronics. For MicroLogic, Rogowski CTs measure the current and a second CT, with an iron core, provides the electrical supply.
Demand current, demand power and peak values	Average of the instantaneous current or power values over an adjustable fixed or sliding time interval. The highest value observed over the time interval is the peak value. The time interval runs from the last reset.
Instantaneous current	True rms value of the current measured by the current transformers over a sliding time interval. Available on MicroLogic 5/6 E.
Instantaneous voltage	True rms value of the voltage measured by the voltage sensors over a sliding time interval. Available on MicroLogic 5/6 E.
Maximeters/minimeters	MicroLogic 5 and 6 E can record the minimum and maximum values of electrical parameters over set time periods.
Overvoltage category (OVC - Overvoltage category) IEC 60947-1. Annex H	Standard IEC 60664-1 stipulates that it is up to the user to select a measurement device with a sufficient overvoltage category, depending on the network voltage and the transient overvoltages likely to occur. Four overvoltage categories define the field of use for a device. <ul style="list-style-type: none"> ■ Cat. I. Devices supplied by a SELV isolating transformer or a battery. ■ Cat. II. Residential distribution, handheld or laboratory tools and devices connected to Standardized 2P + earth electrical outlets (230 V). ■ Cat. III. Industrial distribution, fixed distribution circuits in buildings (main low voltage switchboards, rising mains, elevators, etc.). ■ Cat. IV. Utility substations, overhead lines, certain industrial equipment.
Percent load	Percentage of current flowing through the circuit breaker with respect to its rated current. MicroLogic 6 E-M offers this information and can sum it over the total operating time to provide the load profile for the following ranges, 0 to 49%, 50 to 79%, 80 to 89% and $\geq 90\%$.
Phase sequence	The order in which the phases are connected (L1, L2, L3 or L1, L3, L2) determines the direction of rotation for three-phase asynchronous motors. MicroLogic 6 E-M trip units provide this information.
Power and energy metering (consumption)	The digital electronics in MicroLogic 5/6 E calculate the instantaneous power levels, apparent (S in kVA), active (P in kW) and (Q in kV), and integrate over a time interval to determine the corresponding energies (kVAh, kWh kvarh). Calculations are for each phase and for the total.
Time-stamped histories	MicroLogic trip units store information on events (e.g. alarms and their cause) that are time-stamped to within a millisecond.



Glossary

Protection

Ground-fault protection G (Ig)	Protection function specific to electronic circuit breakers, symbolized by G (Ground). This protection can calculate high-threshold residual earth-leakage currents (in the order of tens of Amperes) on the basis of phase-current measurements. MicroLogic 5/6 offers this protection function with adjustable pick-up Ig and time delay.
Instantaneous protection I (Ii)	This protection supplements Isd. It provokes instantaneous opening of the device. The pick-up may be adjustable or fixed (built-in). This value is always lower than the contact-repulsion level.
Long-time protection L (Ir)	Protection function where the adjustable Ir pick-up determines a protection curve similar to the thermal-protection curve (inverse-time curve I ² t). The curve is generally determined on the basis of the Ir setting which corresponds to a theoretically infinite tripping time (asymptote) and of the point at 6 Ir at which the tripping time depends on the rating.
Magnetic protection (Ii)	Short-circuit protection provided by magnetic trip units (see this term). The pick-up setting may be fixed or adjustable.
Neutral protection (IN)	The neutral is protected because all circuit-breaker poles are interrupted. The setting may be that used for the phases or specific to the neutral, i.e. reduced neutral (0.5 times the phase current) or OSN (oversized neutral) at 1.6 times the phase current. For OSN protection, the maximum device setting is limited to 0.63 In.
Residual-current earth-leakage protection (IΔn)	Protection provided by VigiPacT add-on, in which the residual-current toroids directly detect low-threshold earth-leakage currents (in the order of tens of mA) caused by insulation faults.
Short-delay protection S (Isd)	Protection function specific to electronic circuit breakers, symbolized by S (Short delay or short time). This protection supplements thermal protection. The reaction time is very short, but has a slight time delay to enable selectivity with the upstream device. The short-delay pick-up Isd is adjustable from approximately 1.5 to 10 Ir.
Short-delay protection with fixed time delay So (Isd)	Short-delay protection, but with a fixed time delay. This function is available on MicroLogic 2. It is symbolized by So. It ensures selectivity with downstream devices.
Thermal protection (Ir)	Overload protection provided by thermal trip units (see this term) using an inverse-time curve (I ² t).



Relays and auxiliary contacts

Auxiliary contact IEC 60947-1	Contact included in an auxiliary circuit and mechanically operated by the switching device.
Break contact IEC 60947-1	Control or auxiliary contact which is open when the main contacts of the mechanical switching device are closed and closed when they are open.
Make contact IEC 60947-1	Control or auxiliary contact which is closed when the main contacts of the mechanical switching device are closed and open when they are open.
Relay (electrical) IEC 60947-1	Device designed to produce sudden, predetermined changes in one or more electrical output circuits when certain conditions are fulfilled in the electrical input circuits controlling the device.
Relay module with static output	Output of a relay made up of a thyristor or triac electronic component. The low interrupting capacity means that a power relay is required. This is the case for the SDx and SDTAM outputs.

Switchgear

Circuit breaker
IEC 60947-2



Mechanical switching device, capable of making, carrying and breaking currents under normal circuit conditions and also making, carrying for a specified time and breaking currents under specified abnormal circuit conditions such as those of short circuit. Circuit breakers are the device of choice for protection against overloads and short-circuits. Circuit breakers may, as is the case for ComPacT NSX, be suitable for isolation.

Circuit-breaker utilization category
IEC 60947-2

The standard defines two utilization categories, A and B, depending on breaker selectivity with upstream breakers under short-circuit conditions.

- Category A. Circuit breakers not specifically designed for selectivity applications.
- Category B. Circuit breakers specifically designed for selectivity, which requires a short time-delay (which may be adjustable) and a rated short-time withstand current in compliance with the standard.

ComPacT NSX100 to 630 circuit breakers are category A, however, by design, they provide selectivity with downstream devices (see the Selectivity, Cascading and Coordination Guide).

Contactors
IEC 60947-1



Mechanical switching device having only one position of rest, operated otherwise than by hand, capable of making, carrying and breaking currents under normal circuit conditions including operating overload conditions. A contactor is provided for frequent opening and closing of circuits under load or slight overload conditions. It must be combined and coordinated with a protective device against overloads and short-circuits, such as a circuit breaker.

Contactors utilization categories
IEC 60947-4-1

The standard defines four utilization categories, AC1, AC2, AC3 and AC4 depending on the load and the control functions provided by the contactor. The class depends on the current, voltage and power factor, as well as contactor withstand capacity in terms of frequency of operation and endurance.

Current-limiting circuit breaker
IEC 60947-2

A circuit-breaker with a break-time short enough to prevent the short-circuit current reaching its otherwise attainable peak value.

Disconnectors
IEC 60947-3

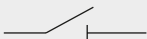

Mechanical switching device which, in the open position, complies with the requirements specified for the isolating function. A disconnector serves to isolate upstream and downstream circuits. It is used to open or close circuits under no-load conditions or with a negligible current level. It can carry the rated circuit current and, for a specified time, the short-circuit current.

Switch-disconnectors
IEC 60947-3



Switch which, in the open position, satisfies the isolating requirements specified for a disconnector. A switch-disconnector serves for switching and isolation. The switch function breaks the circuit under load conditions and the disconnection function isolates the circuit. Protection is not provided. It may be capable of making short-circuit currents if it has the necessary making capacity, but it cannot break short-circuit currents. ComPacT NSX100 to 630 NA switch-disconnectors have a making capacity.

Switch-disconnector utilization category
IEC 60947-3

The standard defines six utilization categories, AC-21A or B, AC-22 A or B, AC23 A or B. They depend on the rated operational current and the mechanical durability (A for frequent operation or B for infrequent operation). ComPacT NSX NA switch-disconnectors comply with utilization categories AC22A or AC23A.



Three-phase asynchronous motors and their protection

Locked-rotor protection (Ijam)

This function steps in when the motor shaft cannot or can no longer drive the load. The result is a high overcurrent.

Long-start protection (Ilong)

An overly long start means the current drawn remains too high or too low for too long, with respect to the starting current. In all cases, the load cannot be driven and the start must be interrupted. The resulting temperature rise must be taken into account before restarting.

Phase-unbalance or phase- loss protection (Iunbal)

This protection function steps in if the current values and/or the unbalance in the three phases supplying the motor exceeds tolerances. Currents should be equal and displacement should be one third of a period. Phase loss is a special case of phase unbalance.

Glossary

Starting current	Start-up of a three-phase, asynchronous motor is characterized by: <ul style="list-style-type: none"> ■ A high inrush current, approximately 14 I_n for 10 to 15 ms ■ A starting current, approximately 7.2 I_n for 5 to 30 seconds ■ Return to the rated current after the starting time.
Starting time	Time after which the motor ceases to draw the starting current and falls back to the operating current I _r (≤ I _n).
Thermal image of the rotor and stator	The thermal image models the thermal behaviour of a motor rotor and stator, taking into account temperature rise caused by overloads or successive starts, and the cooling constants. For each motor power rating, the algorithm takes into account a theoretical amount of iron and copper which modifies the cooling constants.
Thermal protection	Protection against overcurrents following an inverse time curve I ² t = constant, which defines the maximum permissible temperature rise for the motor. Tripping occurs after a time delay that decreases with increasing current.
Trip class IEC 60947-4-1	The trip class determines the trip curve of the thermal protection device for a motor feeder. The standard defines trip classes 5, 10, 20 and 30. These classes are the maximum durations, in seconds, for motor starting with a starting current of 7.2 I _r , where I _r is the thermal setting indicated on the motor rating plate.
Under-load protection (Iund)	This function steps in when the driven load is too low. It detects a set minimum phase current which signals incorrect operation of the driven machine. In the example of a pump, under-load protection detects when the pump is no longer primed.

Trip units

Electronic trip unit (MicroLogic)	Trip unit that continuously measures the current flowing through each phase and the neutral if it exists. For MicroLogic, the measurements are provided by built-in current sensors linked to an analog-digital converter with a high sampling frequency. The measurement values are continuously compared by the ASIC to the protection settings. If a setting is overrun, a Mitop release trips the circuit-breaker operating mechanism. This type of trip unit offers much better pick-up and delay setting accuracy than thermal-magnetic trip units. It also provides a wider range of protection functions.
Magnetic release	Release actuated by a coil or a lever. A major increase in the current (e.g. a short-circuit) produces in the coil or the lever a change in the magnetic field that moves a core. This trips the circuit breaker operating mechanism. Action is instantaneous. The pick-up setting may be adjustable.
Reflex tripping	ComPacT NSX circuit breakers have a patented reflex-tripping system based on the energy of the arc and that is independent of the other protection functions. It operates extremely fast, before the other protection functions. It is an additional safety function that operates before the others in the event of a very high short-circuit.
Release IEC 60947-1	Device, mechanically connected to a mechanical switching device (e.g. a circuit breaker), which releases the holding means and permits the opening or the closing of the switching device. For circuit breakers, releases are often integrated in a trip unit.
Shunt release (MX)	This type of release operates when supplied with current. The MX release provokes circuit-breaker opening when it receives a pulse-type or maintained command.
Thermal-magnetic trip unit	Trip unit combining thermal protection for overloads and magnetic protection.
Thermal release	Release in which a bimetal strip is heated by the Joule effect. Above a temperature-rise threshold that is a function of the current and its duration (I ² t curve = constant, which is representative of temperature rise in cables), the bimetal strip bends and releases the circuit-breaker opening mechanism. The pick-up setting may be adjustable.
Undervoltage release (MN)	This type of release operates when the supply voltage drops below the set minimum.



Additional Characteristics

ComPacT NSXm up to 160 A
TMD Magnetic Trip Units, Tripping Curves
Protection of Distribution Systems H-2
MicroLogic Vigi 4.1, Tripping Curves
Protection of Distribution Systems H-4

ComPacT NSX100 to 250
TMD Magnetic Trip Units, Tripping Curves
Protection of Distribution Systems H-5
MicroLogic 2.2, 4.2 and 2.2 G Electronic Trip Units,
Tripping Curves, Protection of Distribution Systems H-11
MicroLogic 5.2 and 6.2 E and 7.2 E Electronic Trip Units,
Tripping Curves - Protection of Distribution Systems H-12
MA Magnetic Trip Units, MicroLogic 2.2 M Electronic
Trip Units, Tripping Curves - Motor Protection..... H-13
MicroLogic 6.2 E-M Electronic Trip Units, Tripping Curves
Motor Protection..... H-14

ComPacT NSX400 to 630
Thermomagnetic Trip Unit, Trip Curve Distribution Protection..... H-15
MicroLogic 2.3, 4.3, 5.3 and 6.3 E and 7.3 E Electronic
Trip Units, Tripping Curves - Protection of Distribution Systems .. H-16
MicroLogic 6.3 E Electronic Trip Units,
Tripping Curves - Protection of Distribution Systems H-17
MicroLogic 1.3 M and 2.3 M Electronic Trip Units,
Tripping Curves Motor Protection..... H-18
MicroLogic 6.3 E-M Electronic Trip Units,
Tripping Curves Motor Protection..... H-19

Tripping Curves ComPacT NSXm and NSX
Reflex Tripping H-20

Current and Energy Limiting Curves
ComPacT NSXm H-22
ComPacT NSX H-23

Other Chapters
Select Circuit Breakers and Switch-DisconnectorsA-1
Select Protection B-1
Customize Circuit Breakers with Accessories..... C-1
Smart Panel Integration D-1
Switchboard Integration..... E-1
Catalog Numbers F-1
Glossary G-1



ComPacT NSXm up to 160 A

TMD Magnetic Trip Units, Tripping Curves

Protection of Distribution Systems

TM16D

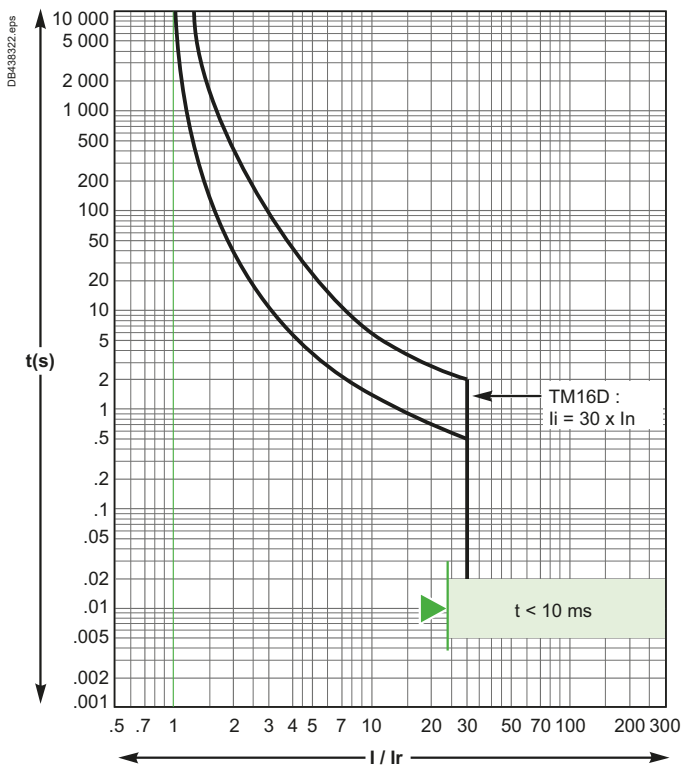

TM25D

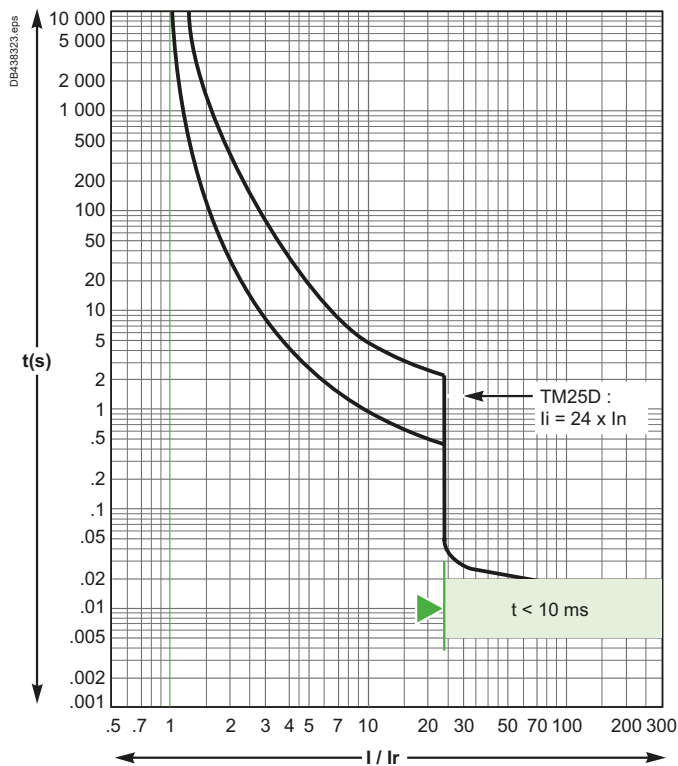

Reflex tripping.

TM32D/TM40D

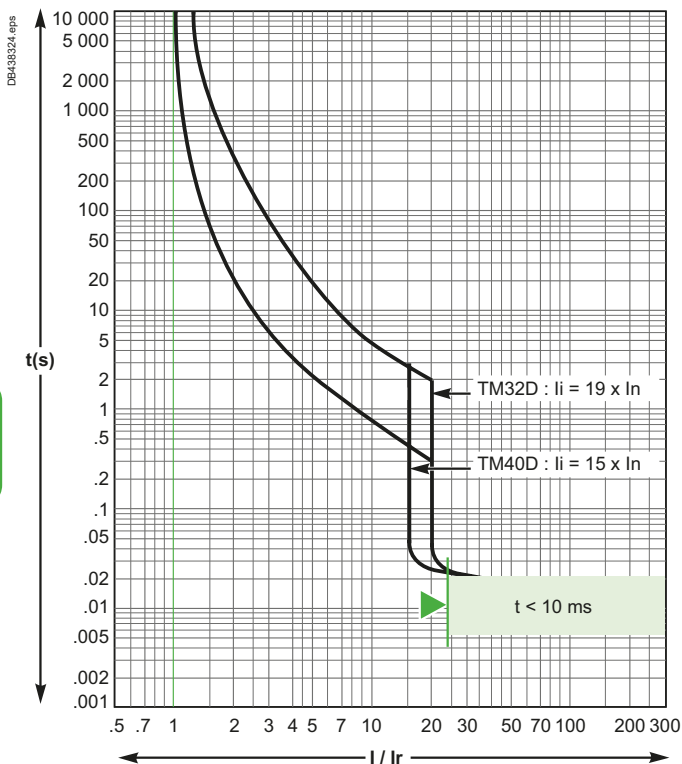

TM50D/TM63D

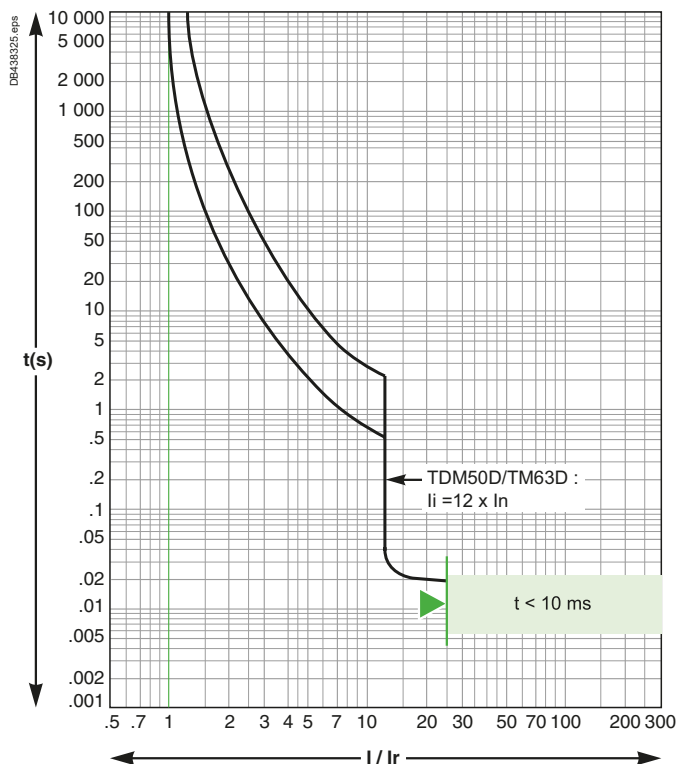

Reflex tripping.



ComPacT NSXm up to 160 A

TMD Magnetic Trip Units, Tripping Curves

Protection of Distribution Systems

TM80D/TM100D

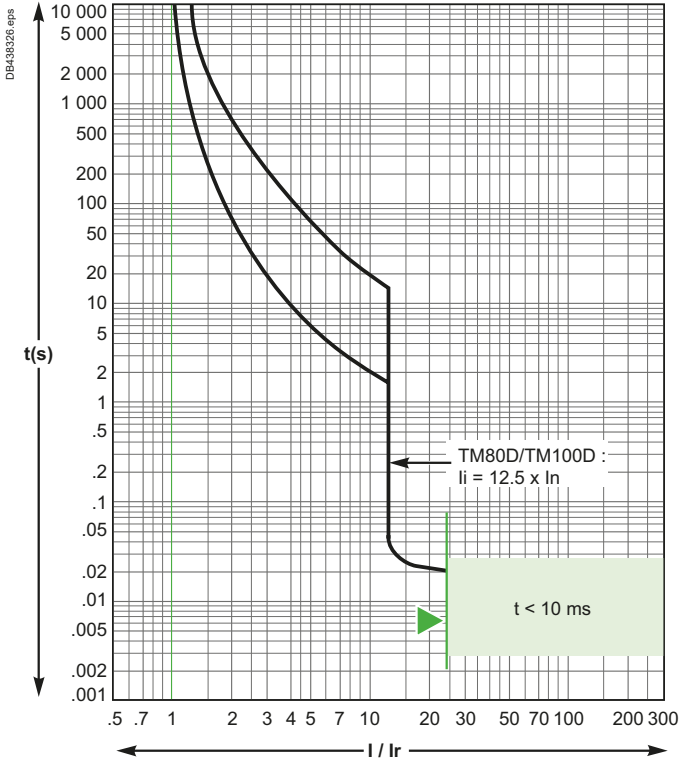

TM125D/TM160D

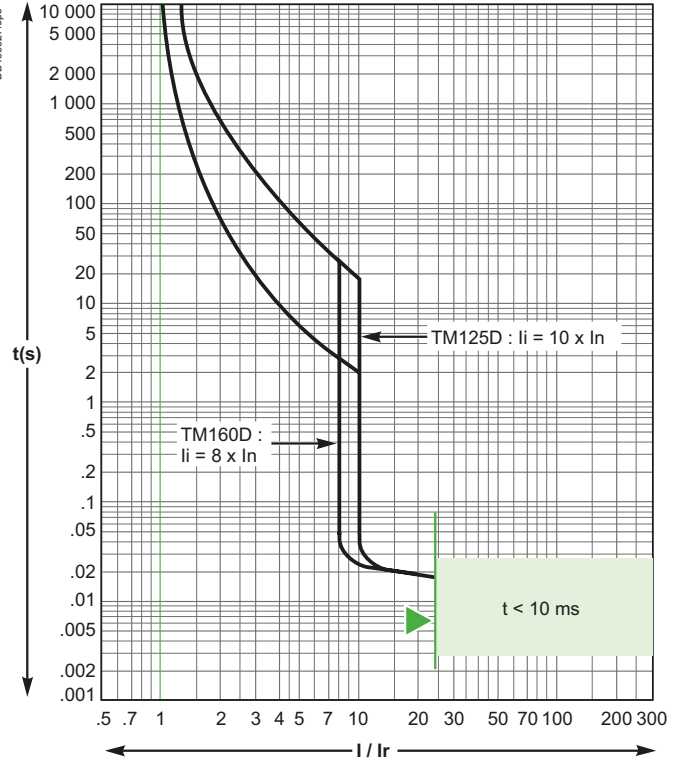

Reflex tripping.

For all TMD curves:
 Values are given for 40 °C ambient, $I_r = 1 \times I_n$, 3 poles loaded, cold start.
 For $I_r = k \times I_n$, read the time corresponding to $1/k$ times given current.
 For 1 pole tripping, read the time corresponding to 0.85 times given current.
 For hot start ($0.9 \times I_r$), divide max. time by 2, min. time by 4.



ComPacT NSXm up to 160 A

MicroLogic Vigi 4.1, Tripping Curves

Protection of Distribution Systems

25 A

50 A

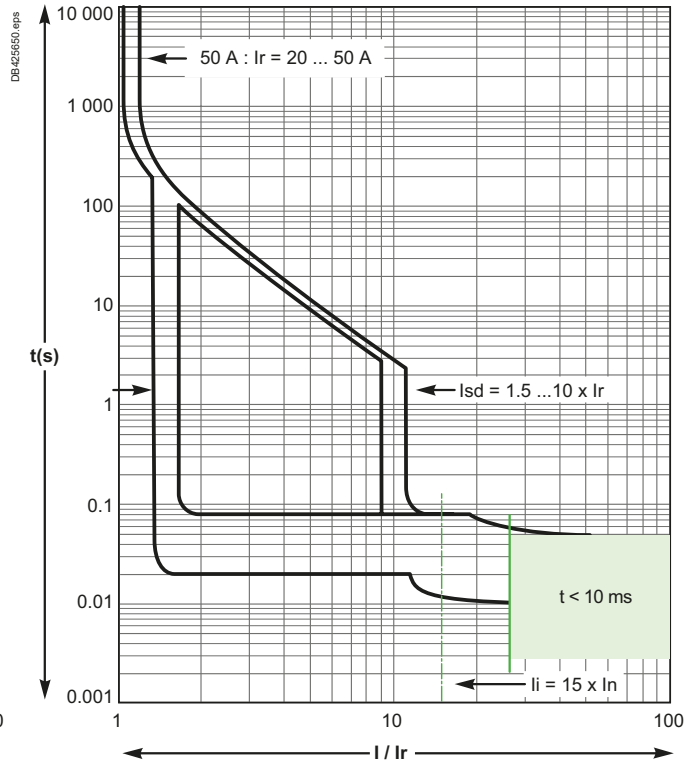
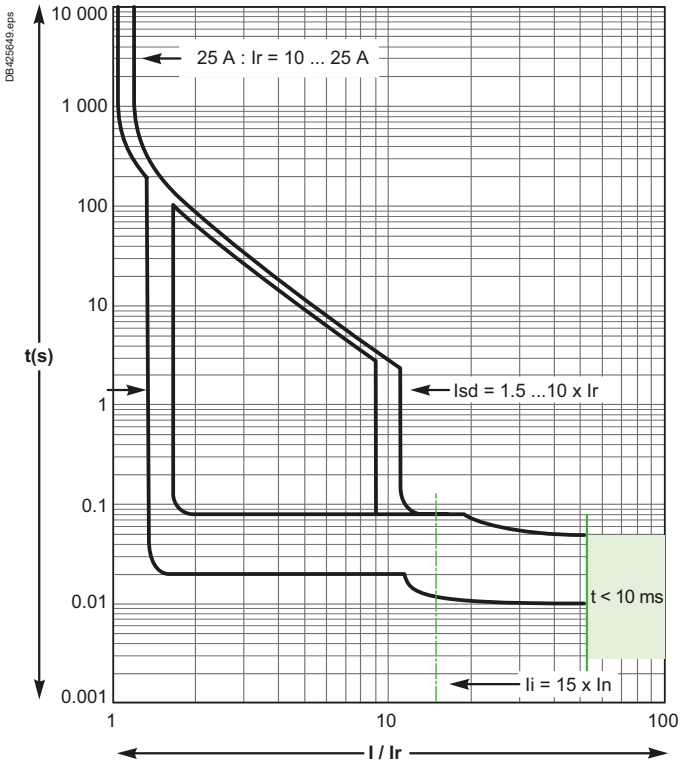

100 A

160 A

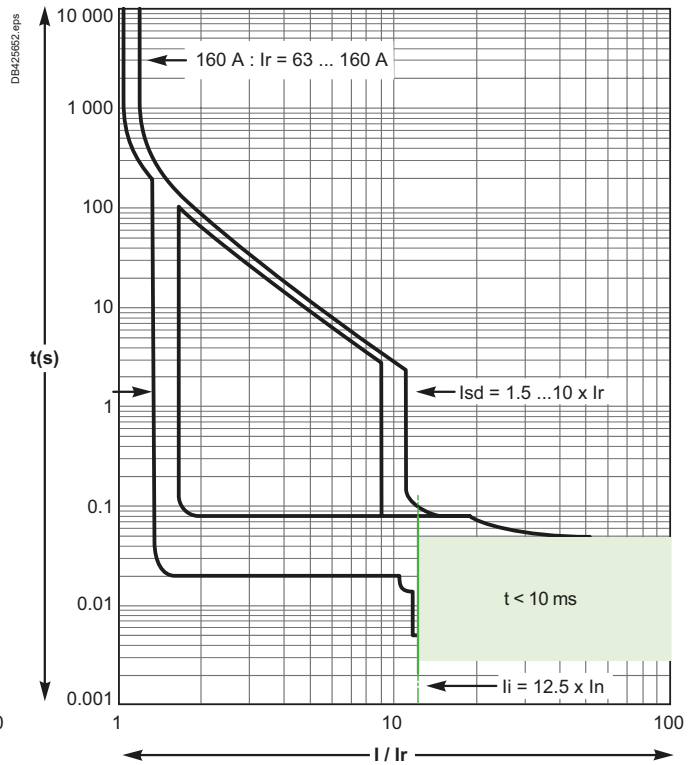
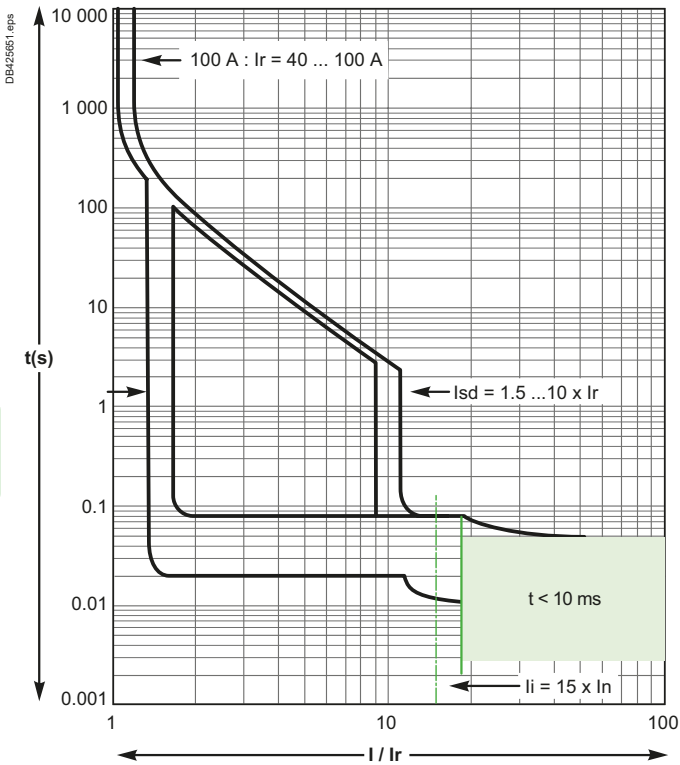

Reflex tripping.



ComPacT NSX100 to 250

TMD Magnetic Trip Units, Tripping Curves

Protection of Distribution Systems

TM16D

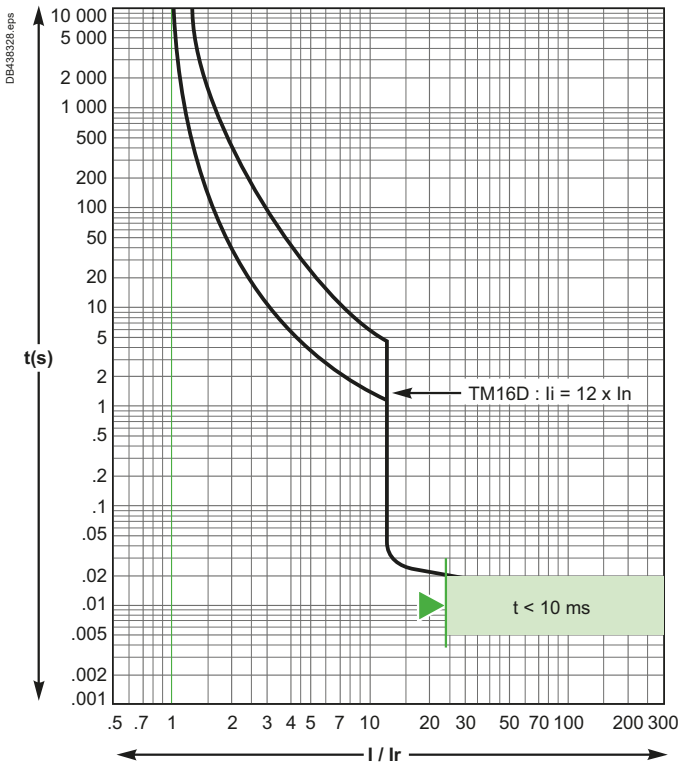

TM25D

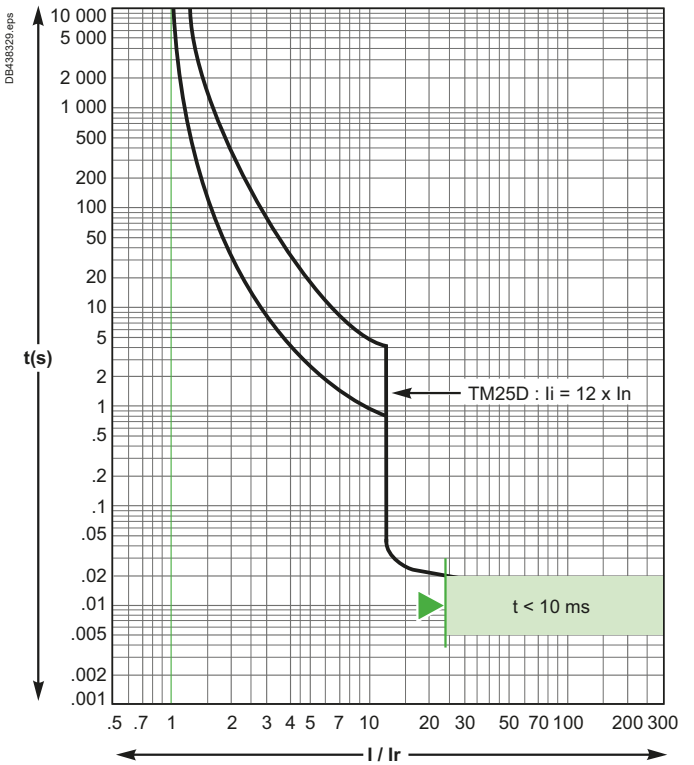

Reflex tripping.

TM30D/TM32D

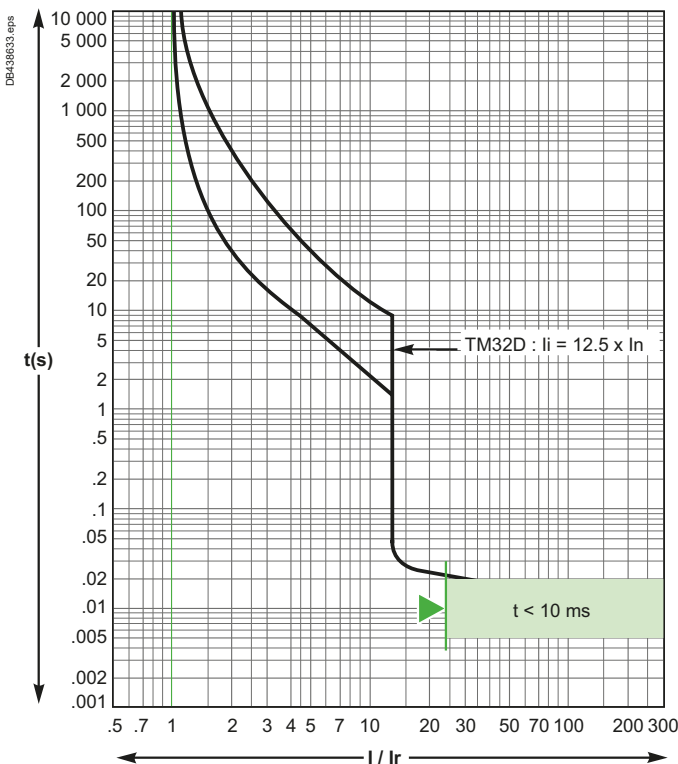

TM40D

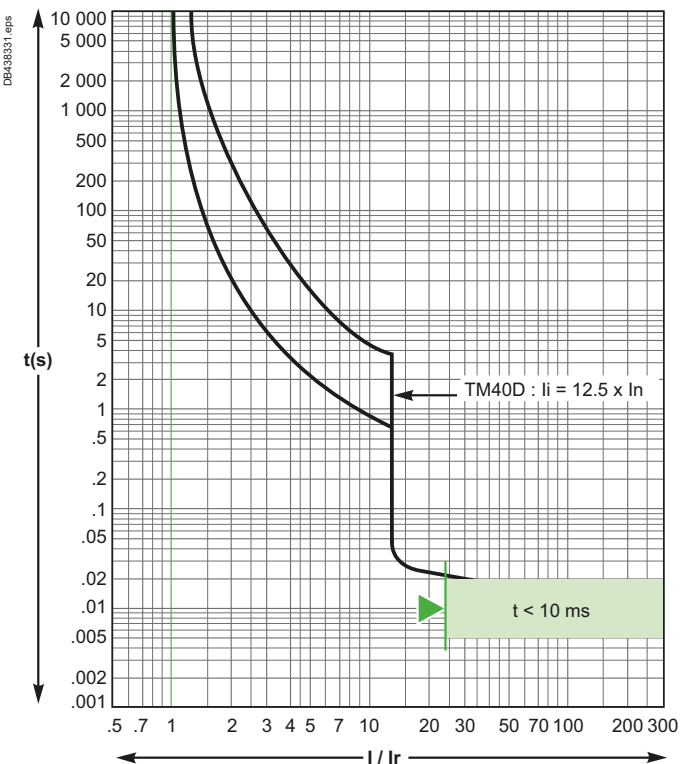

Reflex tripping.



ComPacT NSX100 to 250

TMD Magnetic Trip Units, Tripping Curves

Protection of Distribution Systems

TM50D

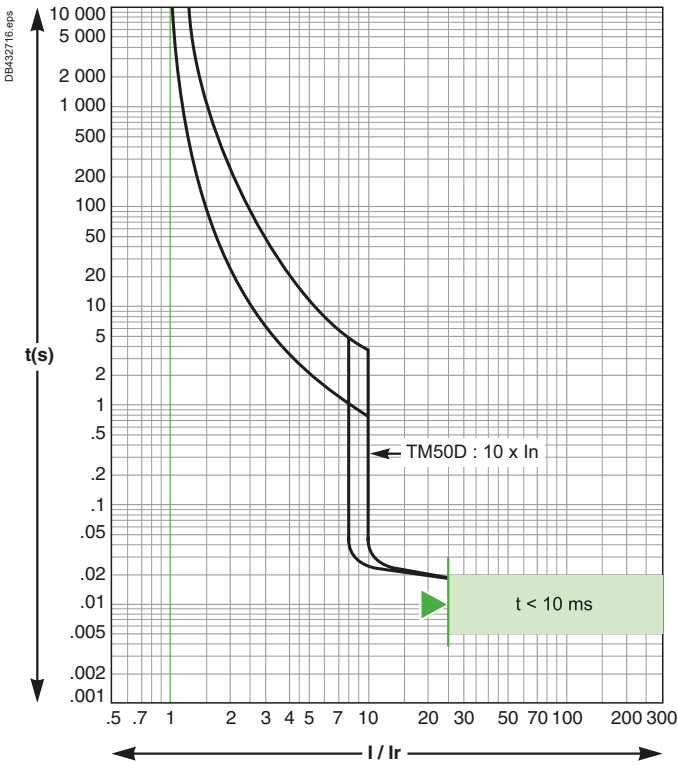

TM63D

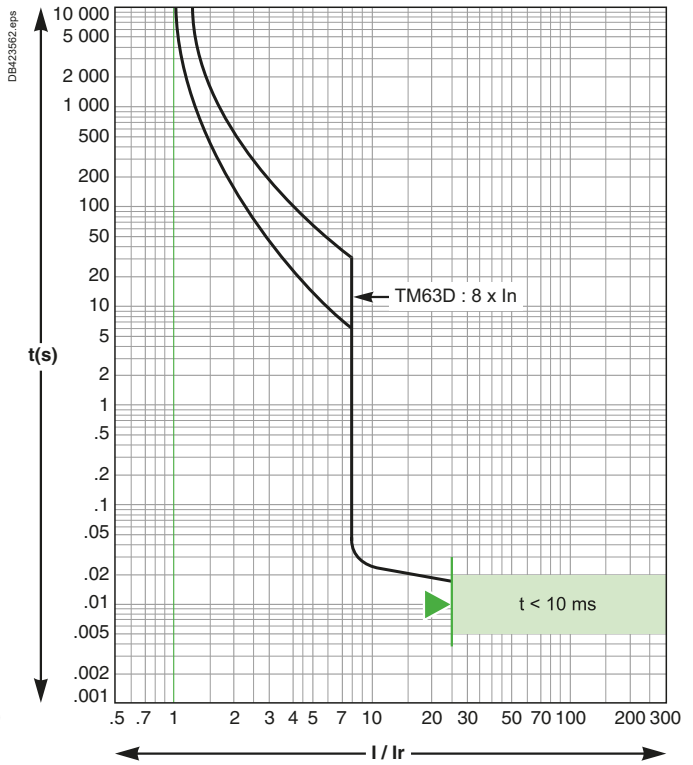

Reflex tripping.

TM80D/TM100D

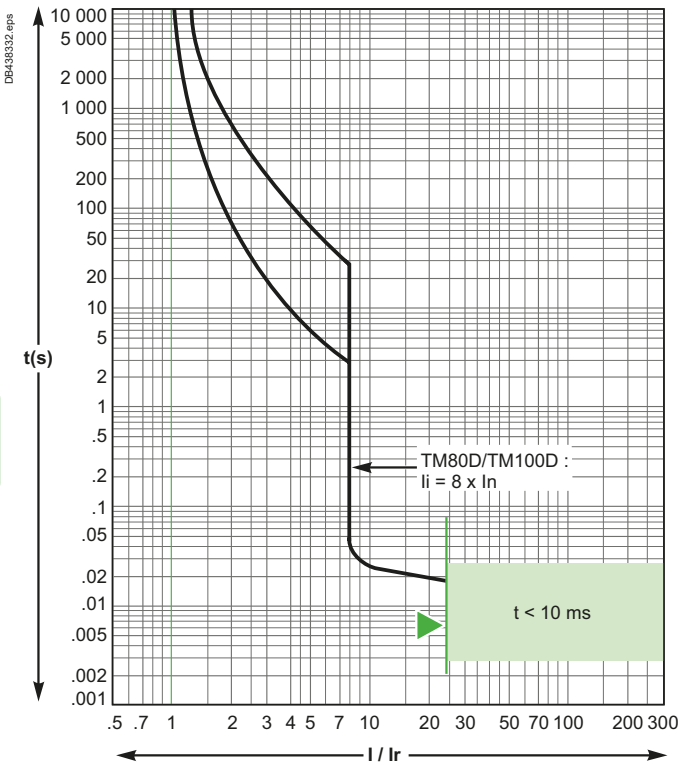

TM125D/TM160D

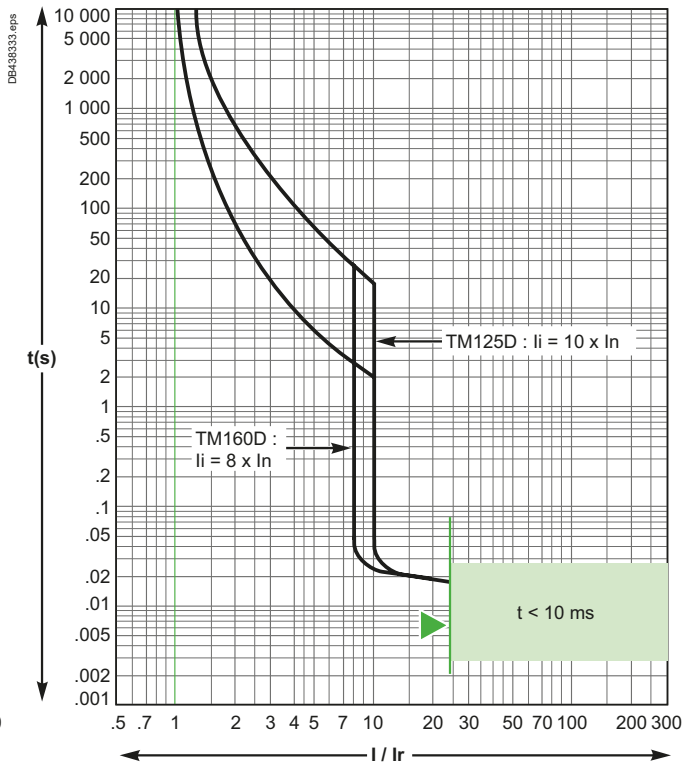

Reflex tripping.



ComPacT NSX100 to 250 TMD Magnetic Trip Units, Tripping Curves Protection of Distribution Systems

TM200D/TM250D

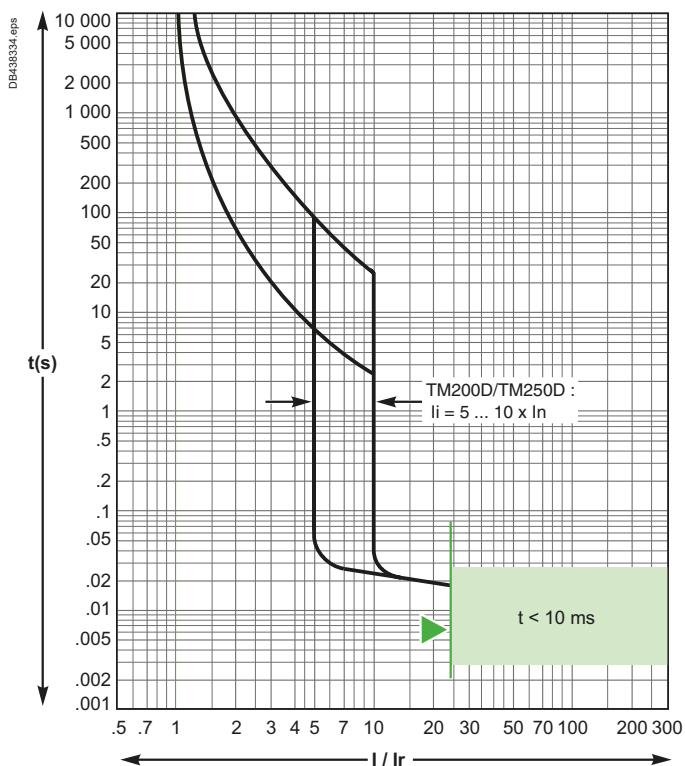

Reflex tripping.

For all TMD Curves:

Values are given for 40 °C ambient, Ir = 1xIn, 3 poles loaded, cold start.

For Ir = k x In, read the time corresponding to 1/k times given current.

For 1 pole tripping, read the time corresponding to 0.85 times given current.

For hot start (0.9 x Ir), divide max. time by 2, min. time by 4.

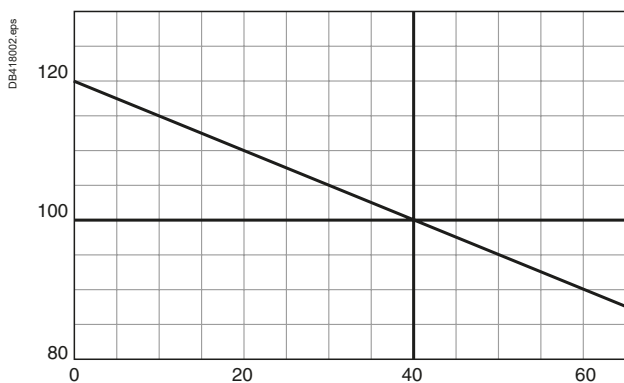

ComPacT NSX100 to 250

TMG Magnetic Trip Units, Tripping Curves

Protection of Distribution Systems

TM16G

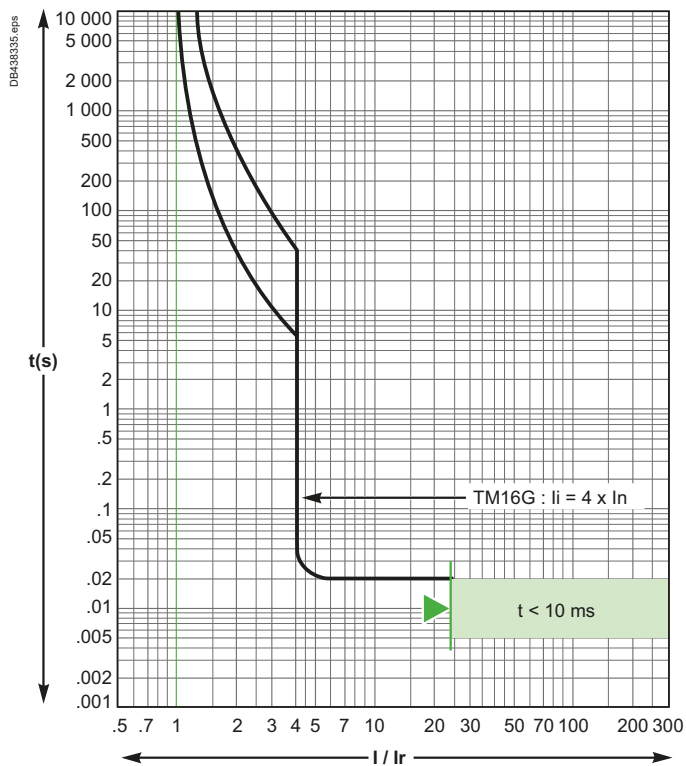

Reflex tripping.

TM25G

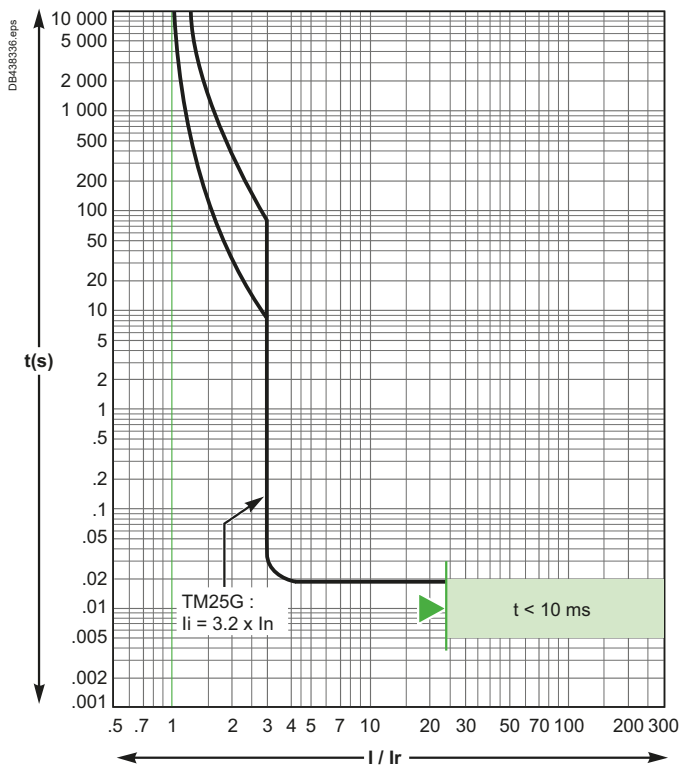

TM40G

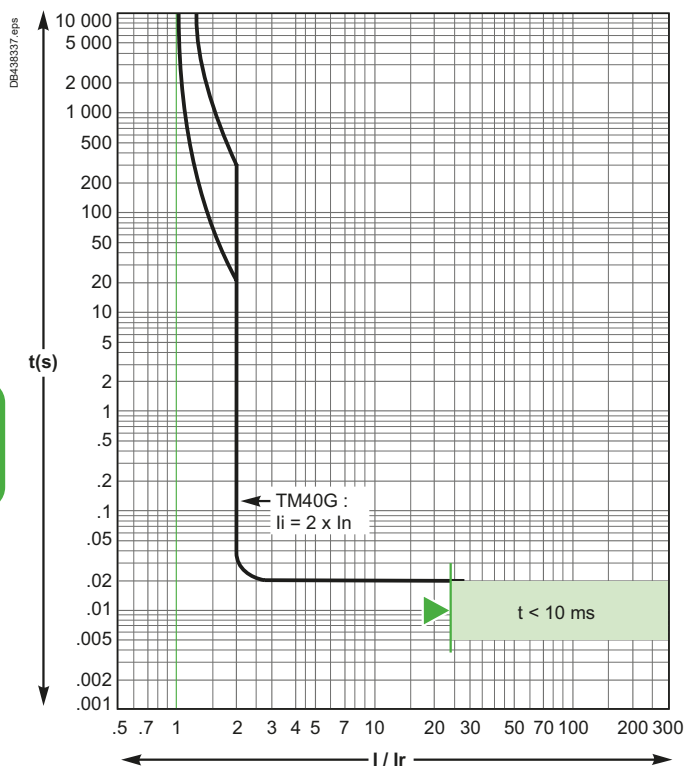

Reflex tripping.

TM63G

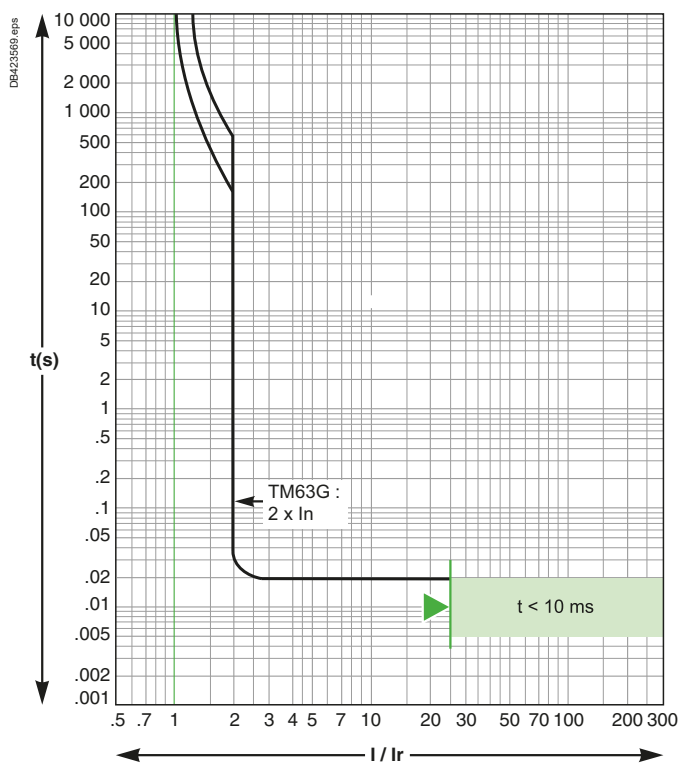

ComPacT NSX100 to 250 TMG Magnetic Trip Units, Tripping Curves Protection of Distribution Systems

TM80G

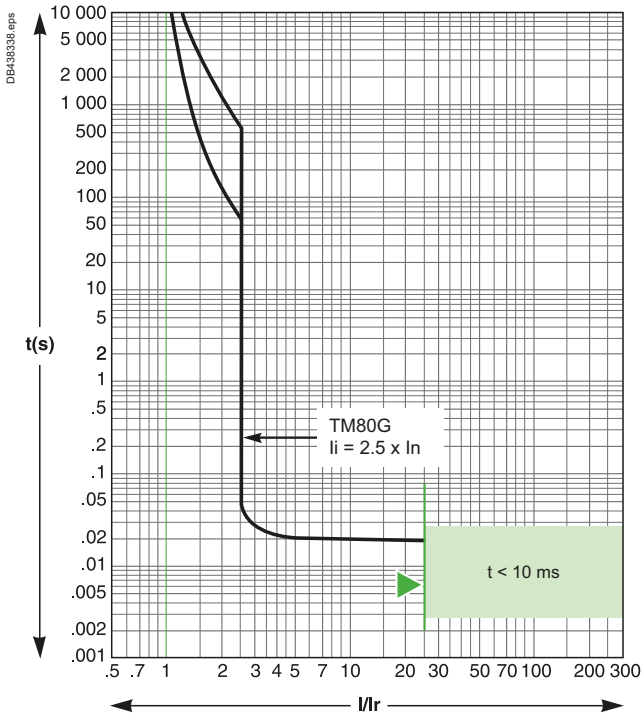

TM100G

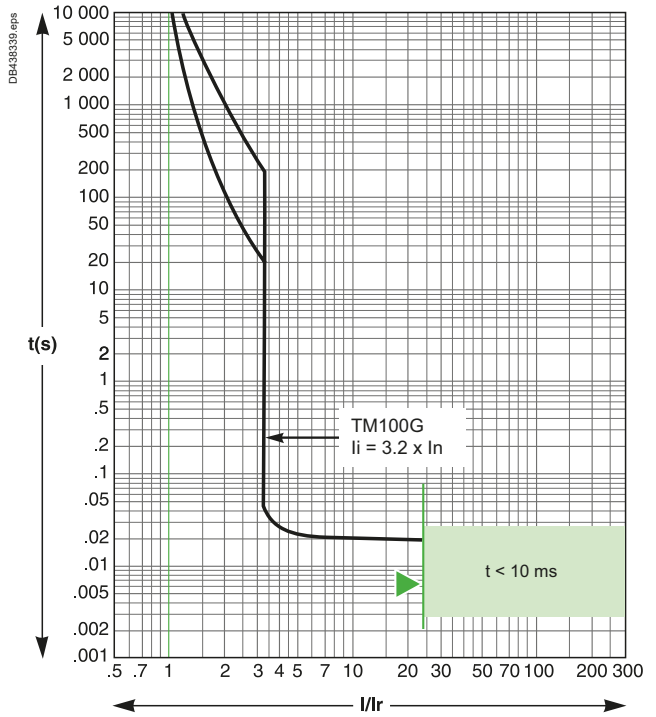

Reflex tripping.

TM125G

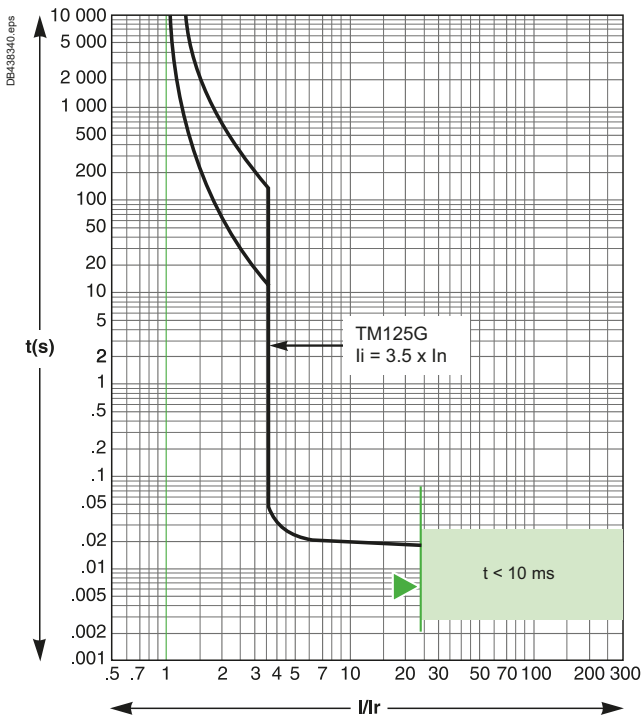

TM160G

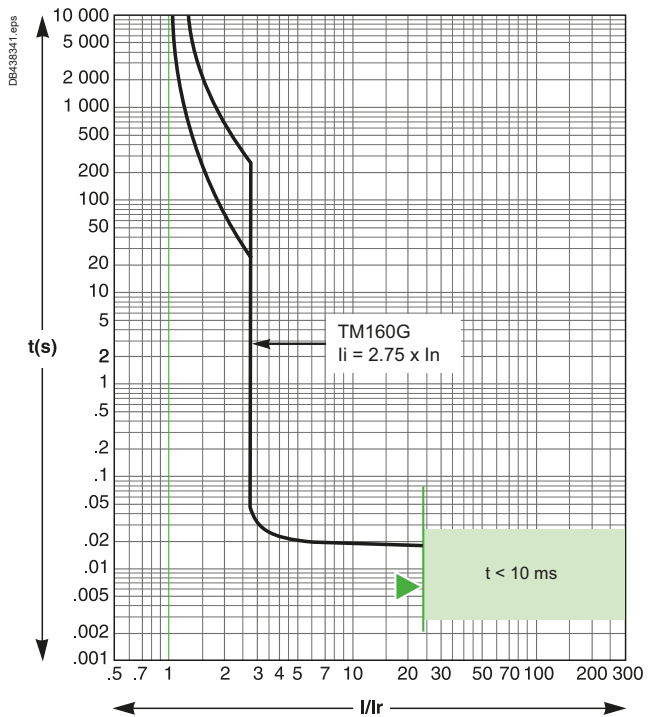

Reflex tripping.



ComPacT NSX100 to 250

TMG Magnetic Trip Units, Tripping Curves

Protection of Distribution Systems

TM200G

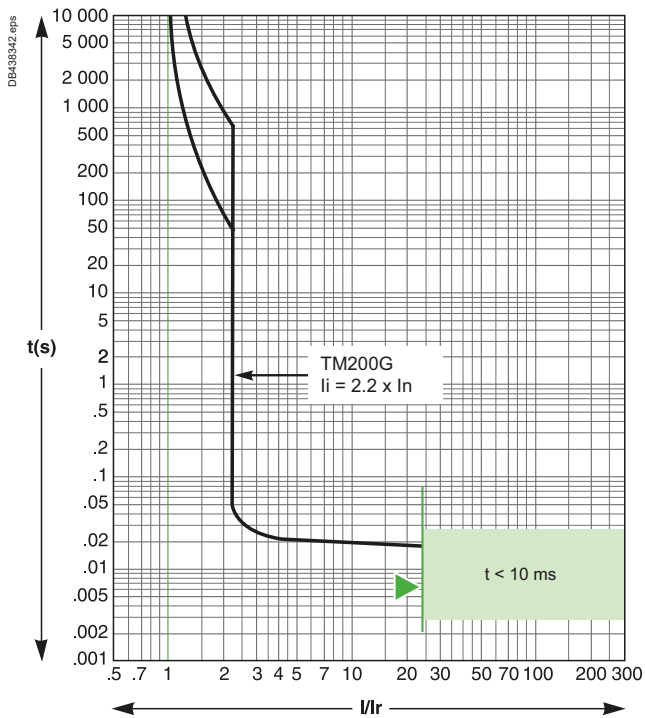

TM250G

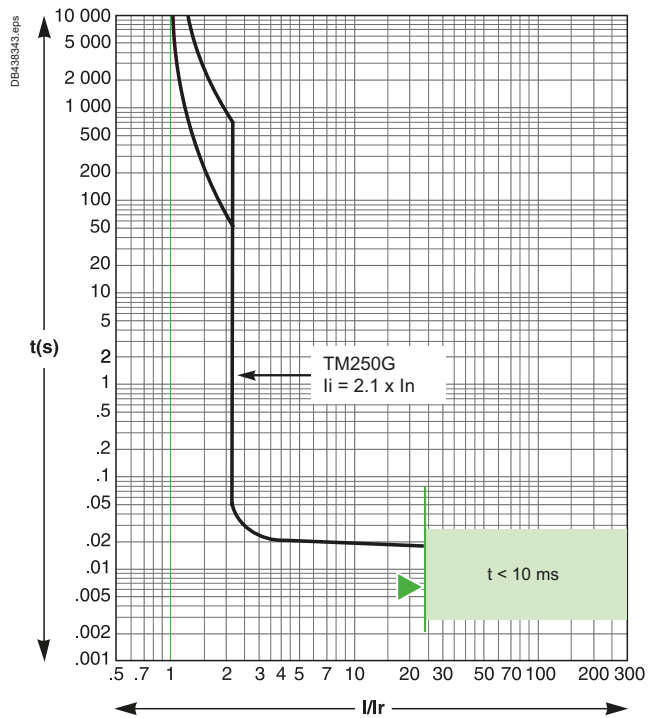

Reflex tripping.

ComPacT NSX100 to 250

MicroLogic 2.2, 4.2 and 2.2 G Electronic Trip Units, Tripping Curves, Protection of Distribution Systems

MicroLogic 2.2, 4.2 - 40... 160 A

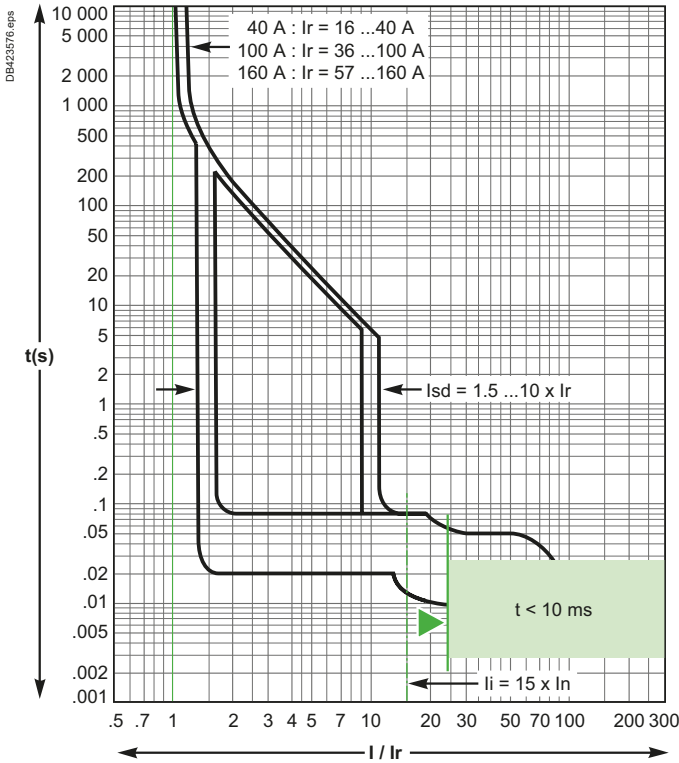

MicroLogic 2.2, 4.2 - 250 A

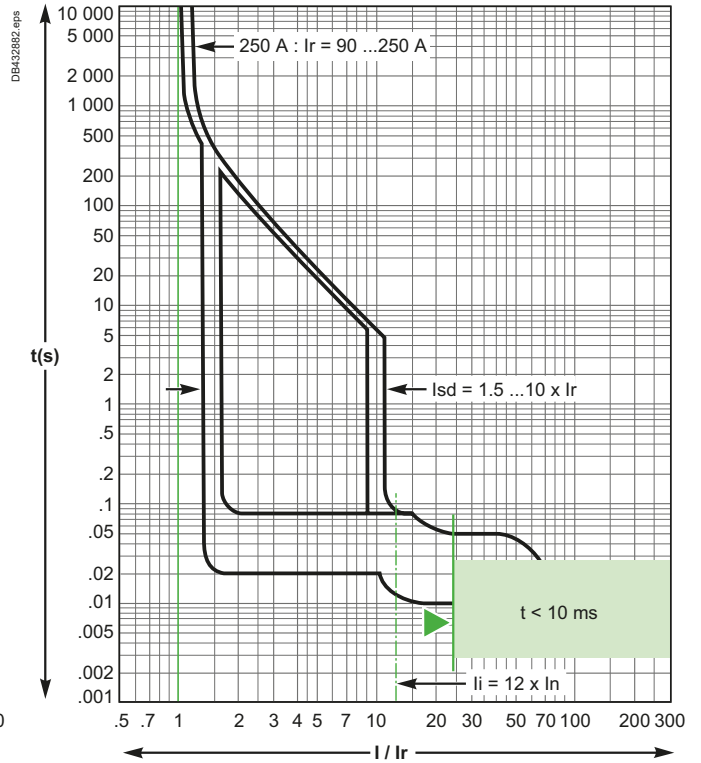

Reflex tripping.

MicroLogic 2.2 G - 40... 160 A

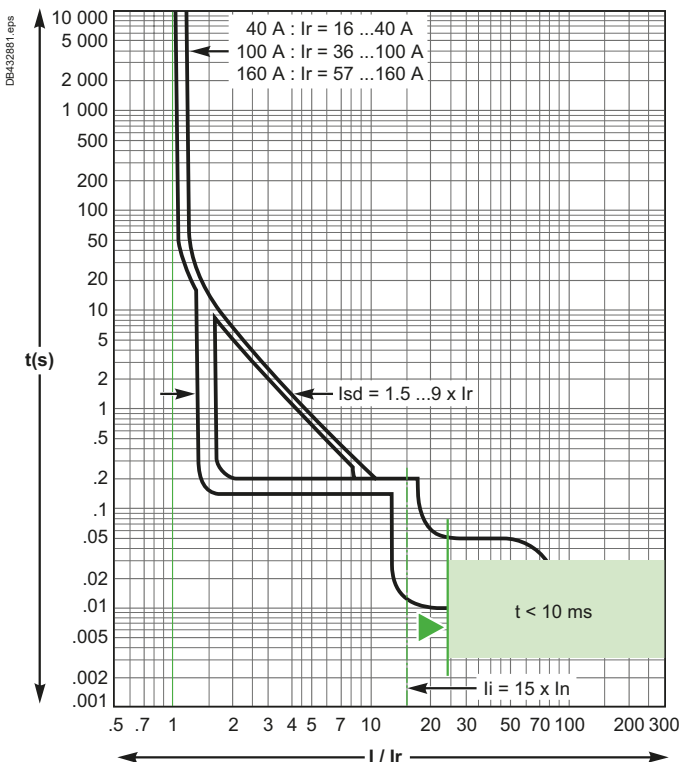

MicroLogic 2.2 G - 250 A

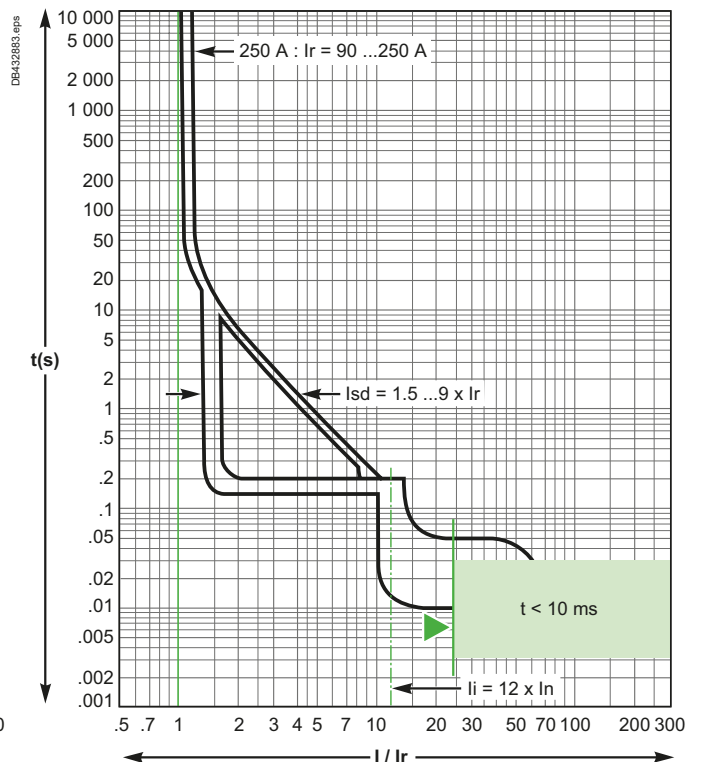

Reflex tripping.



ComPacT NSX100 to 250

MicroLogic 5.2 and 6.2 E and 7.2 E Electronic Trip Units, Tripping Curves - Protection of Distribution Systems

MicroLogic 5.2 E, 6.2 E and 7.2 E - 40... 160 A

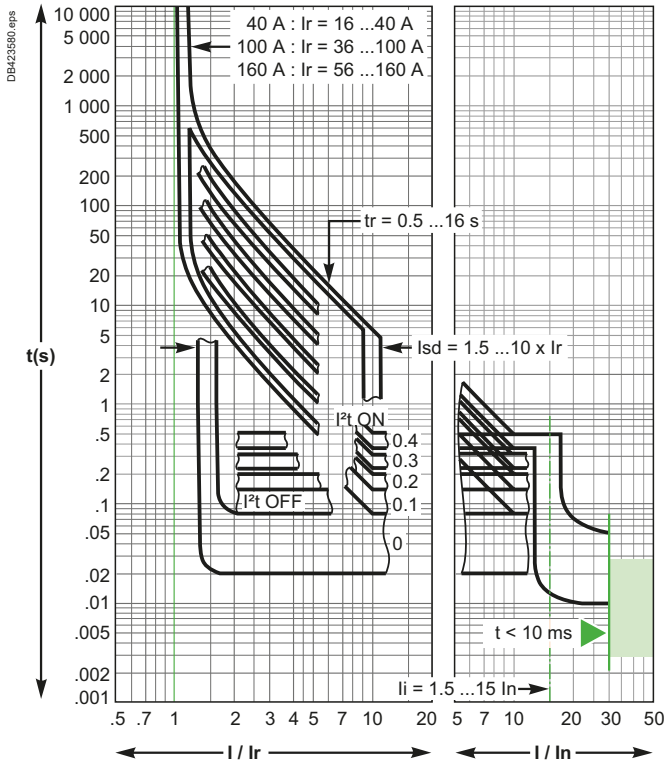

Reflex tripping.

MicroLogic 5.2 E, 6.2 E and 7.2 E - 250 A

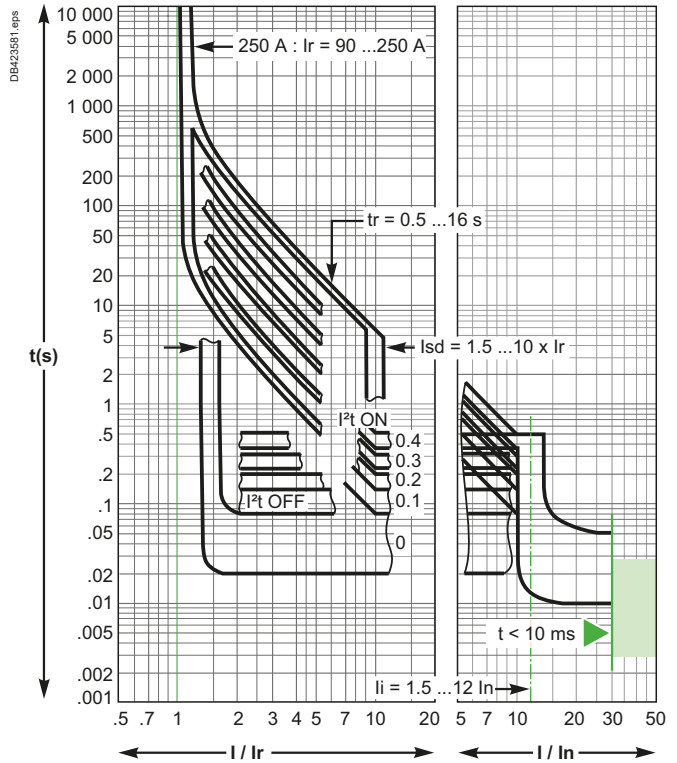

MicroLogic 6.2 E (Ground-Fault Protection)

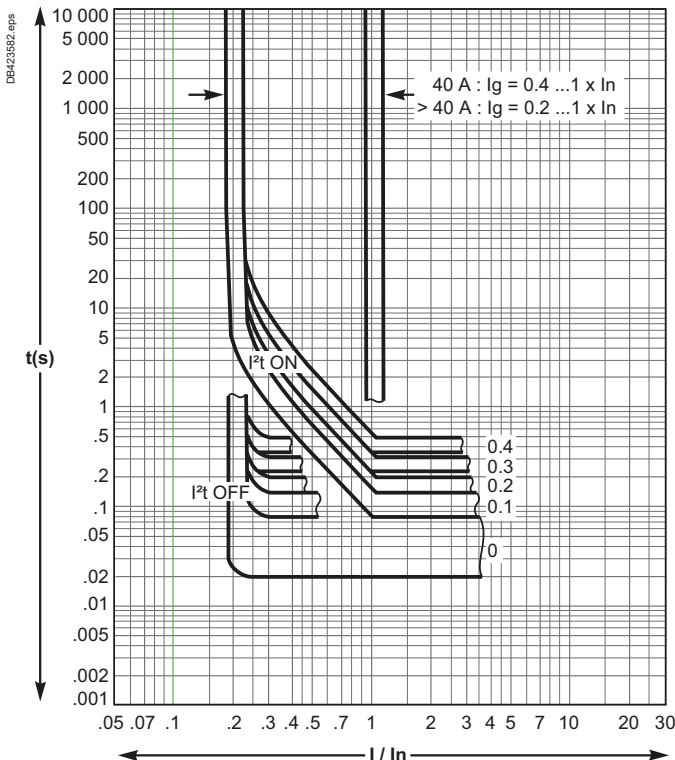

Reflex tripping.



ComPacT NSX100 to 250 MA Magnetic Trip Units, MicroLogic 2.2 M Electronic Trip Units, Tripping Curves - Motor Protection

MA2.5... MA100

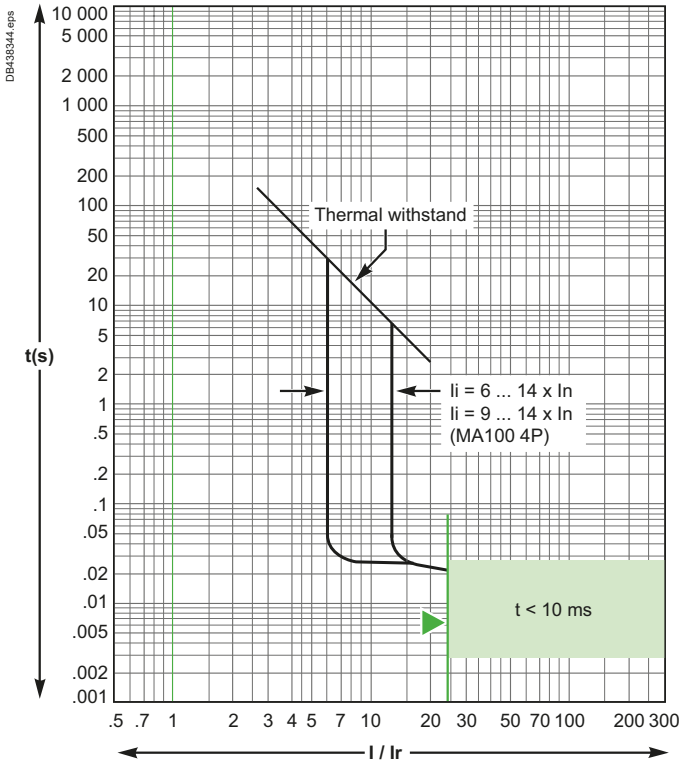

MA150 and MA220

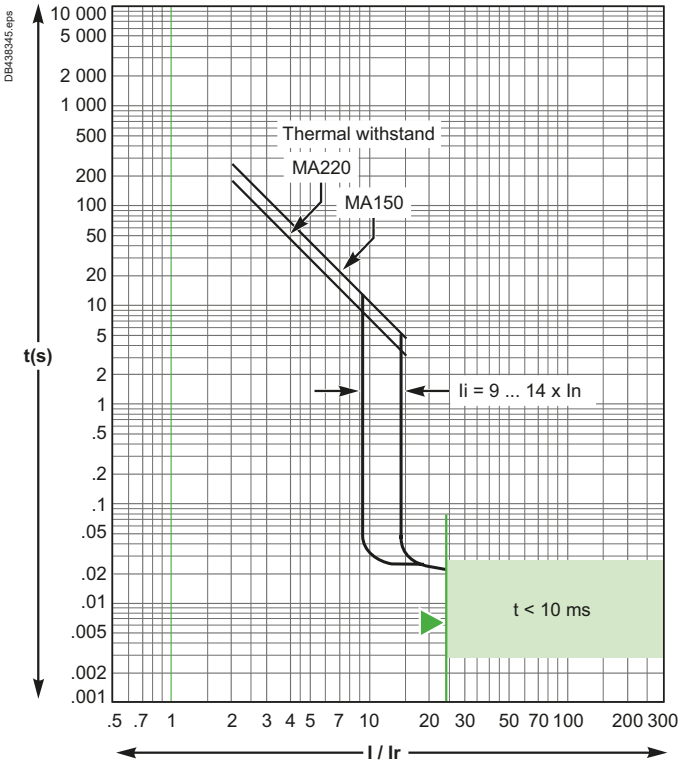

Reflex tripping.

MicroLogic 2.2 M - 25 A

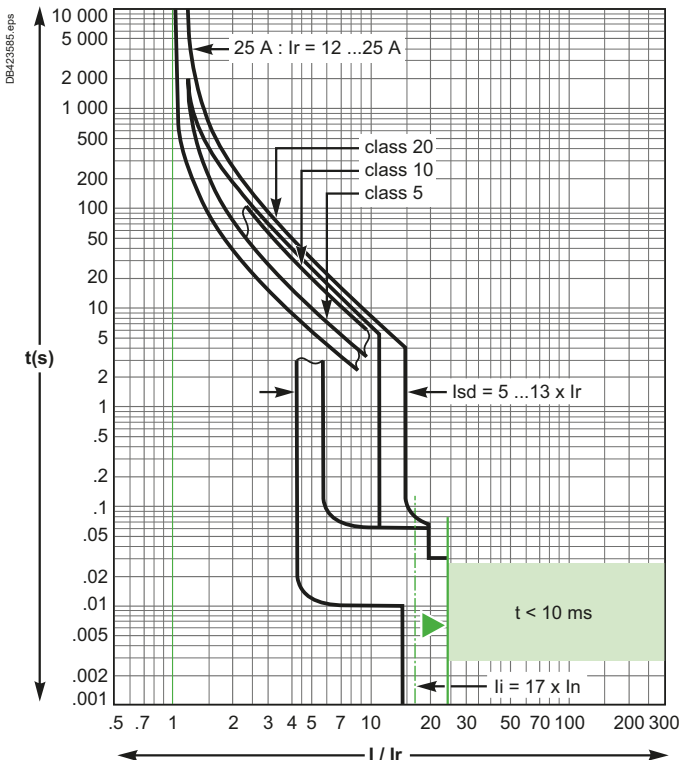

MicroLogic 2.2 M - 50... 220 A

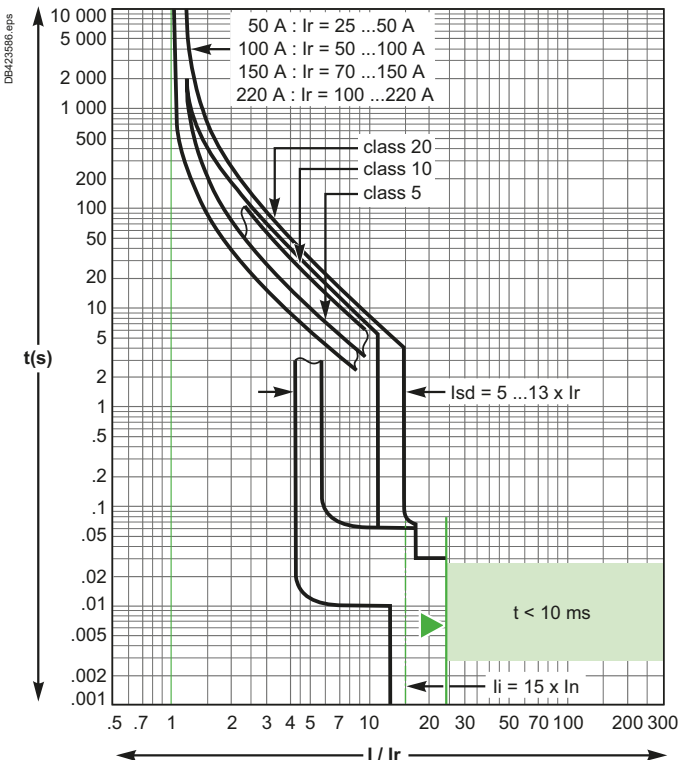

Reflex tripping.



ComPacT NSX100 to 250

MicroLogic 6.2 E-M Electronic Trip Units, Tripping Curves Motor Protection

MicroLogic 6.2 E-M - 25 A

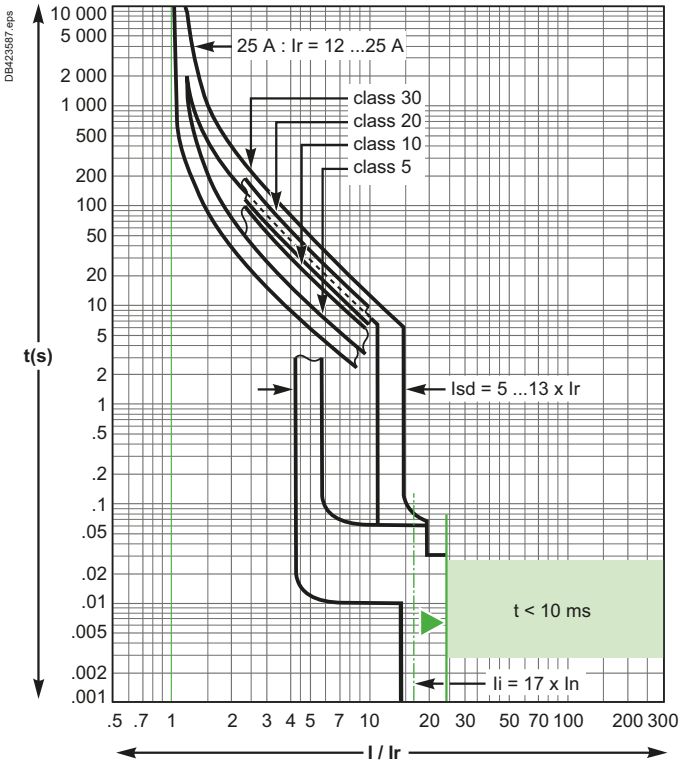

Reflex tripping.

MicroLogic 6.2 E-M - 50... 220 A

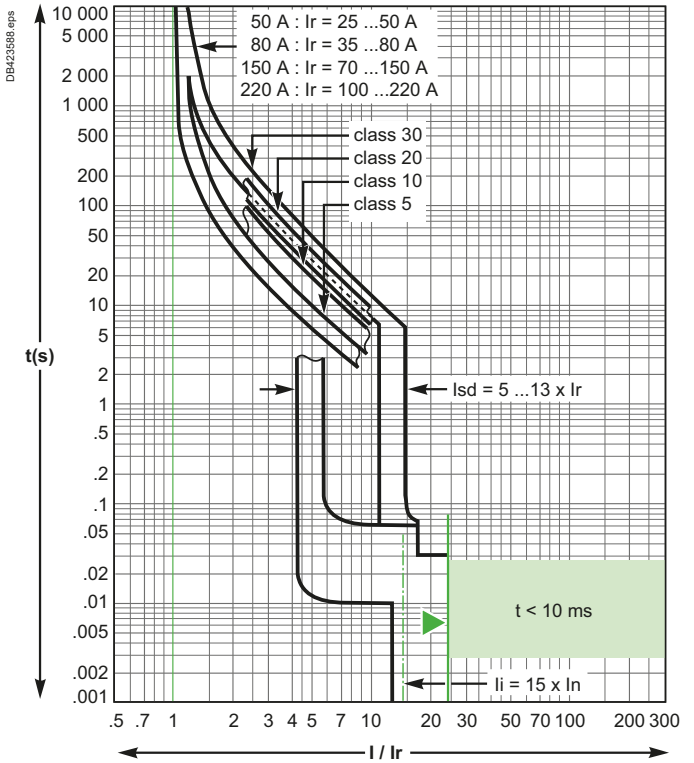

MicroLogic 6.2 E-M (Ground-Fault Protection)

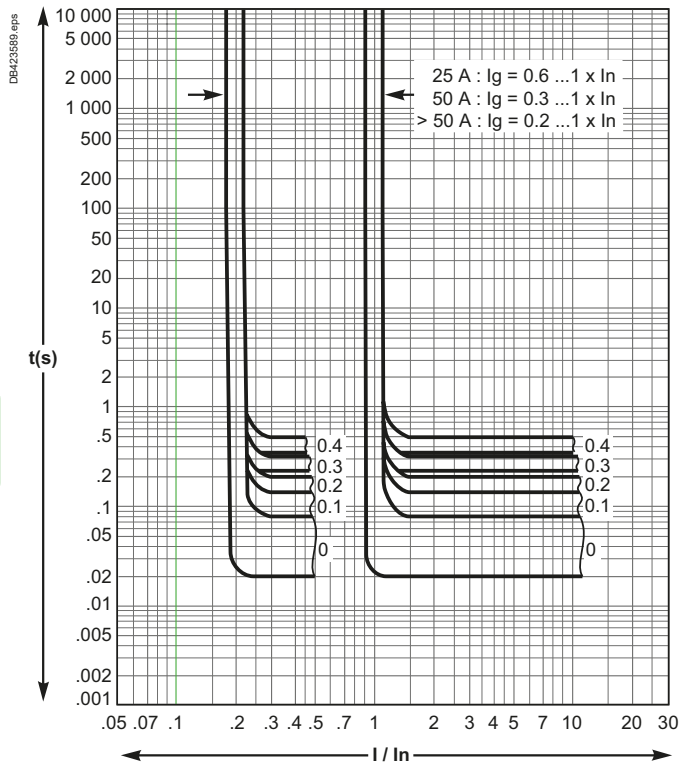

H

ComPacT NSX400 to 630

Thermomagnetic Trip Unit, Trip Curve Distribution Protection

TM400D

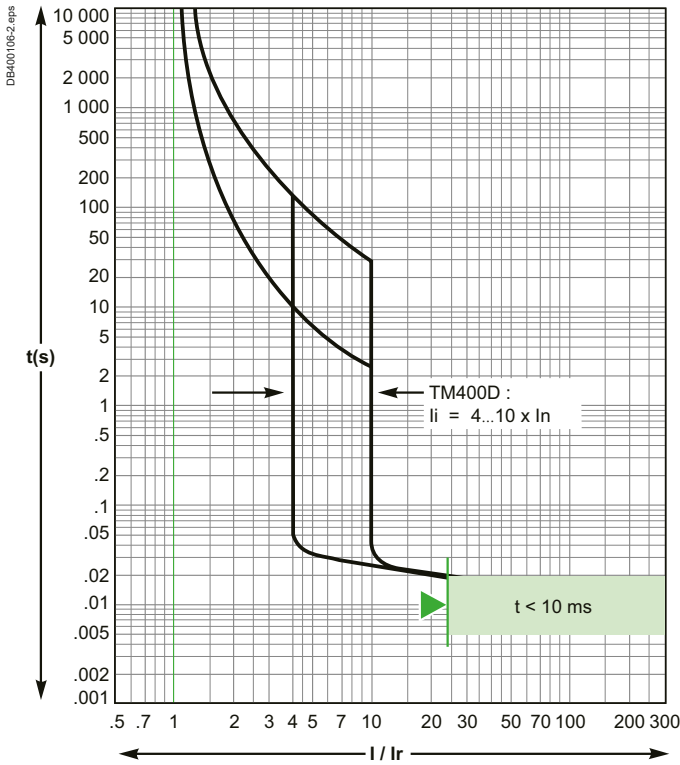

Reflex tripping.

TM630D

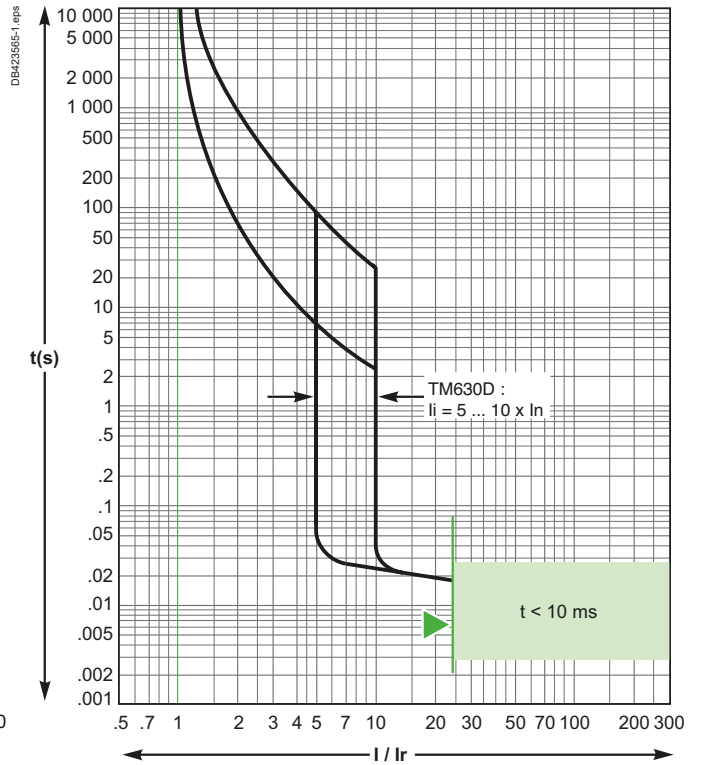

Reflex tripping.



ComPacT NSX400 to 630

MicroLogic 2.3, 4.3, 5.3 and 6.3 E and 7.3 E Electronic Trip Units, Tripping Curves - Protection of Distribution Systems

MicroLogic 2.3, 4.3 - 250... 400 A

MicroLogic 2.3 - 630 A, 4.3 up to 570 A

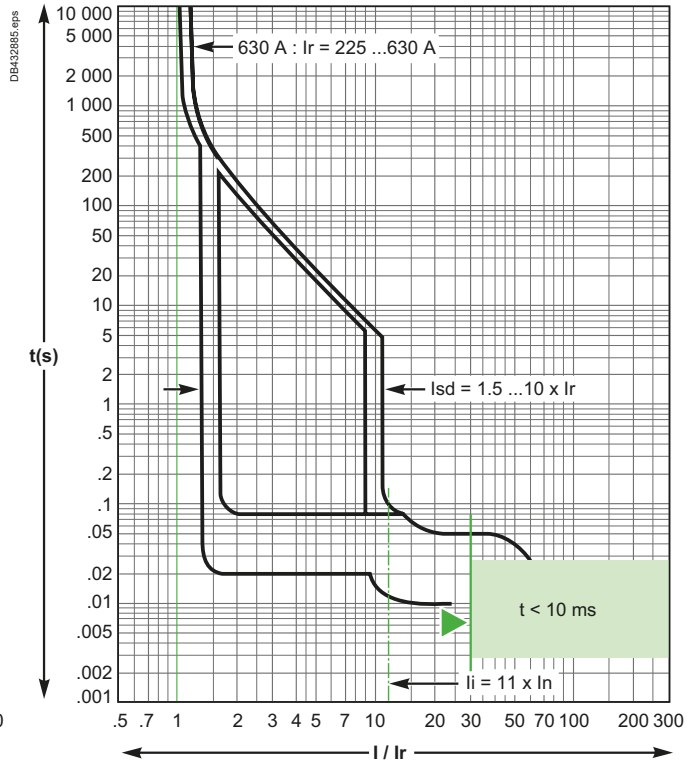
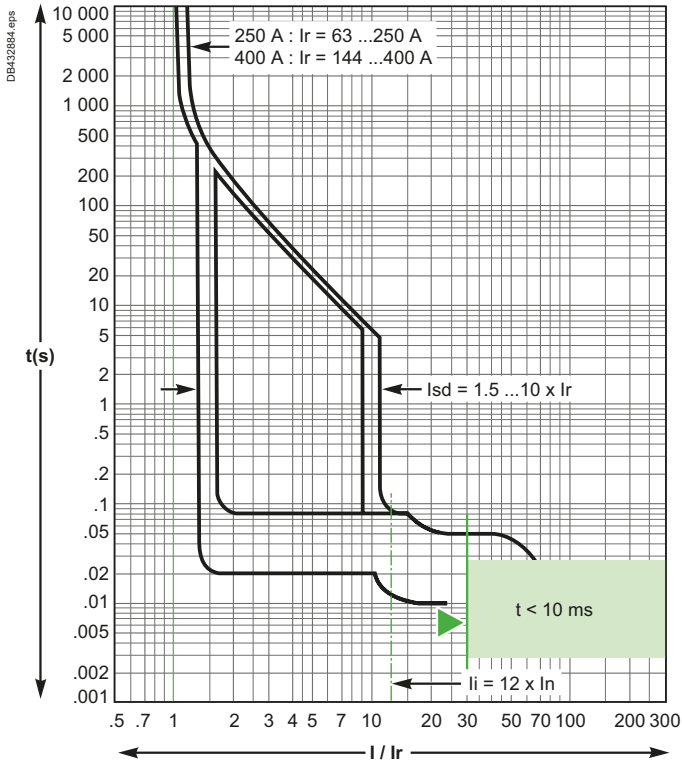

Reflex tripping.

MicroLogic 5.3 and 6.3 E and 7.3 E - 400 A

MicroLogic 5.3 and 6.3 E - 630 A, and 7.3 E up to 570 A

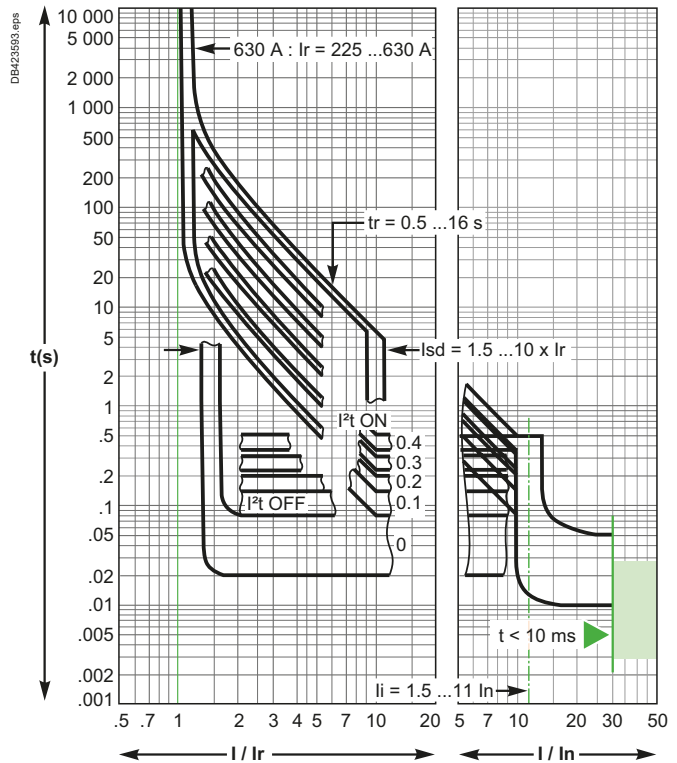
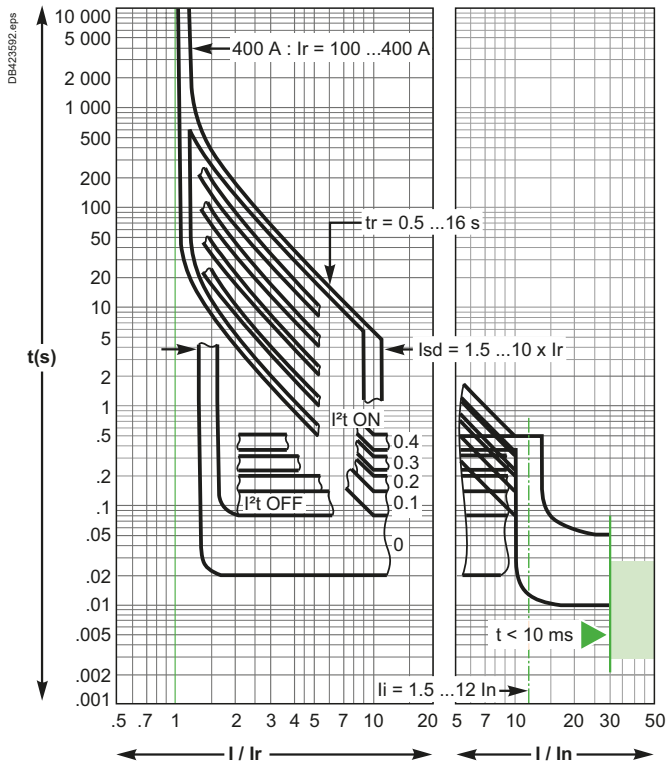

Reflex tripping.

ComPacT NSX400 to 630

MicroLogic 6.3 E Electronic Trip Units, Tripping Curves - Protection of Distribution Systems

MicroLogic 6.3 E (up to 570 A) (Ground-Fault Protection)

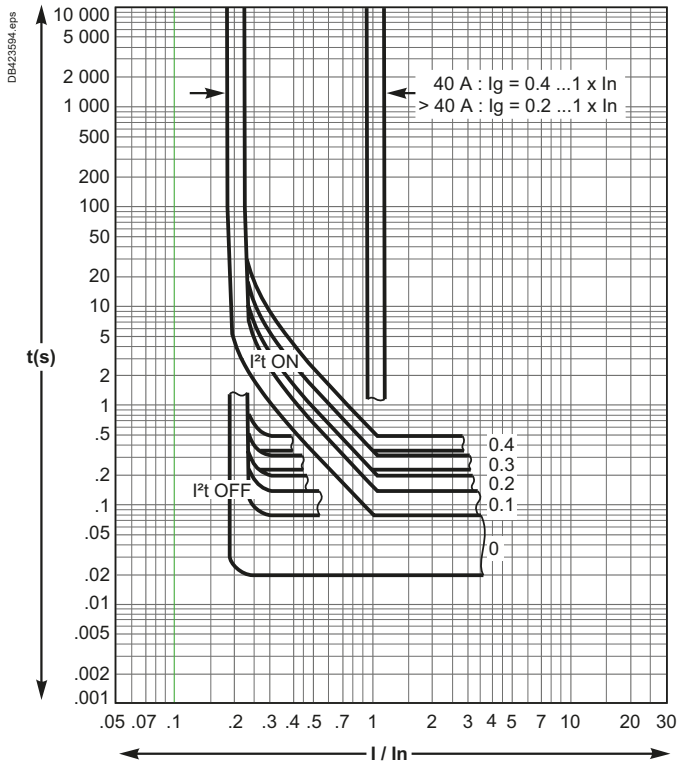

ComPacT NSX400 to 630

MicroLogic 1.3 M and 2.3 M Electronic Trip Units, Tripping Curves Motor Protection

MicroLogic 1.3 M - 320 A

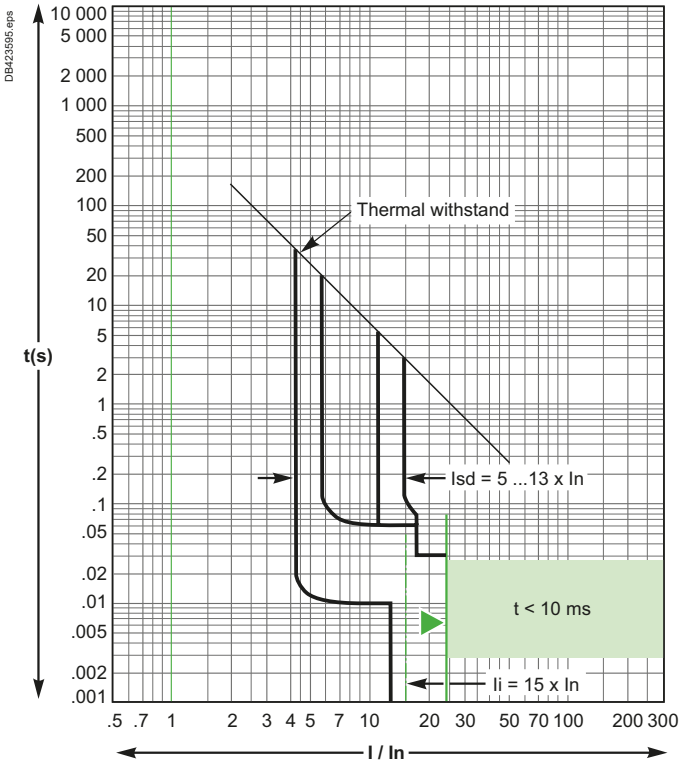

Reflex tripping.

MicroLogic 1.3 M - 500 A

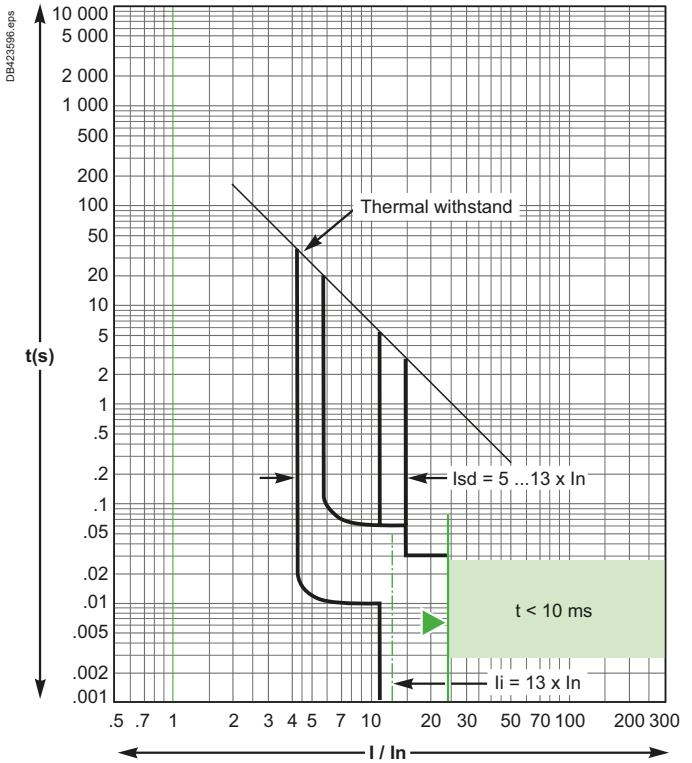

MicroLogic 2.3 M - 320 A

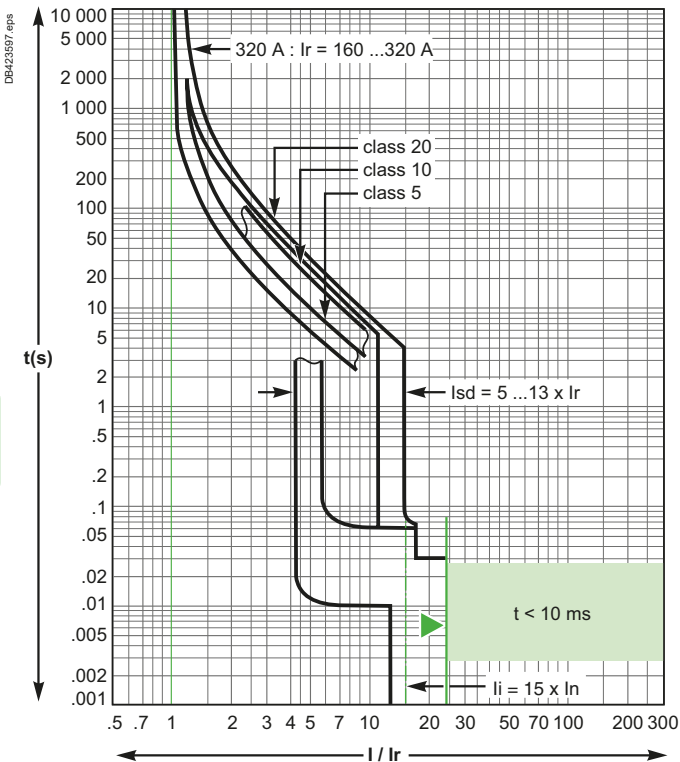

Reflex tripping.

MicroLogic 2.3 M - 500 A

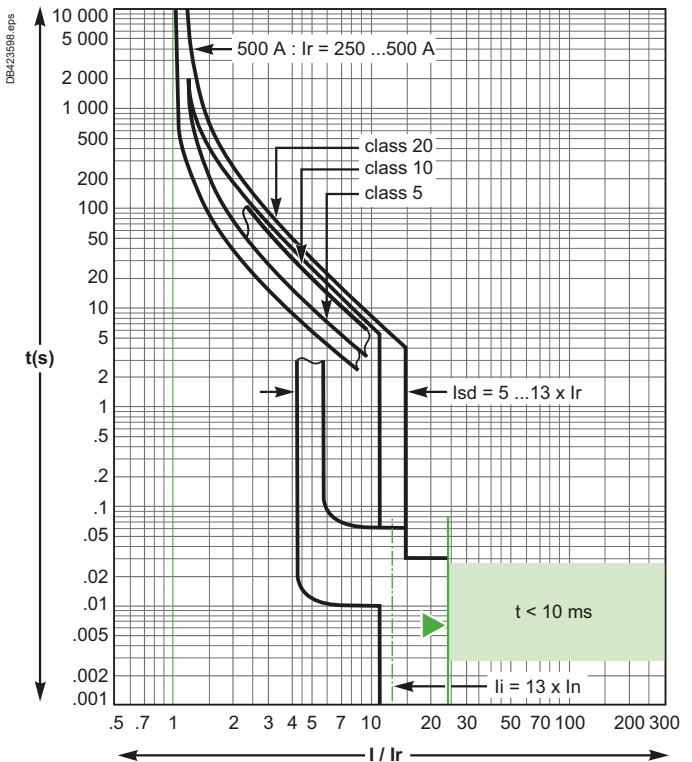

ComPacT NSX400 to 630

MicroLogic 6.3 E-M Electronic Trip Units, Tripping Curves Motor Protection

MicroLogic 6.3 E-M - 320 A

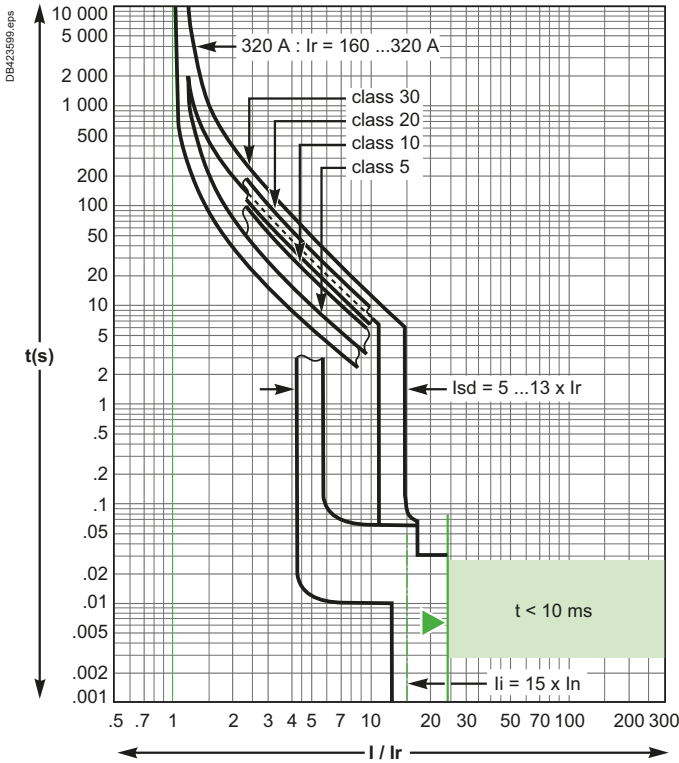

MicroLogic 6.3 E-M - 500 A

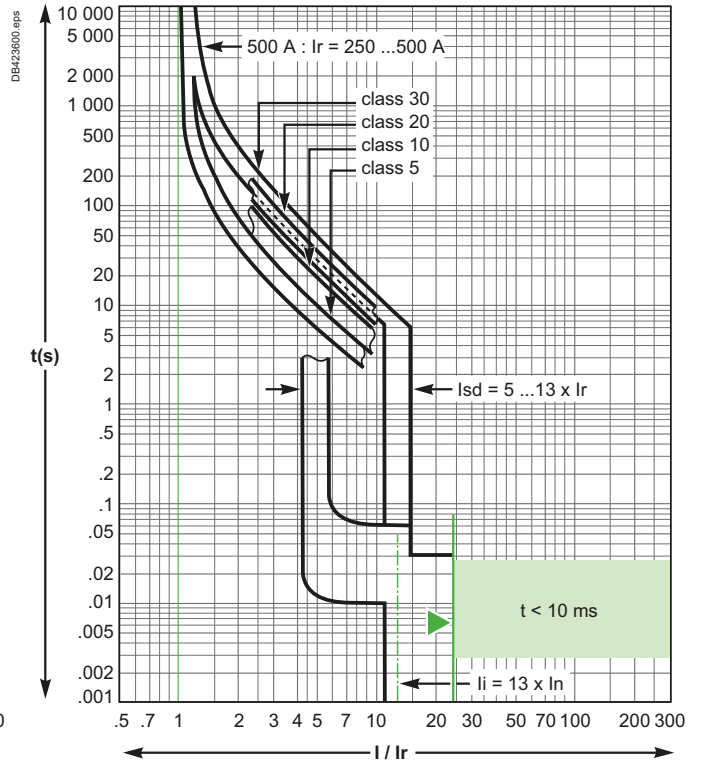

Reflex tripping.

MicroLogic 6.3 E-M (Ground Fault Protection)

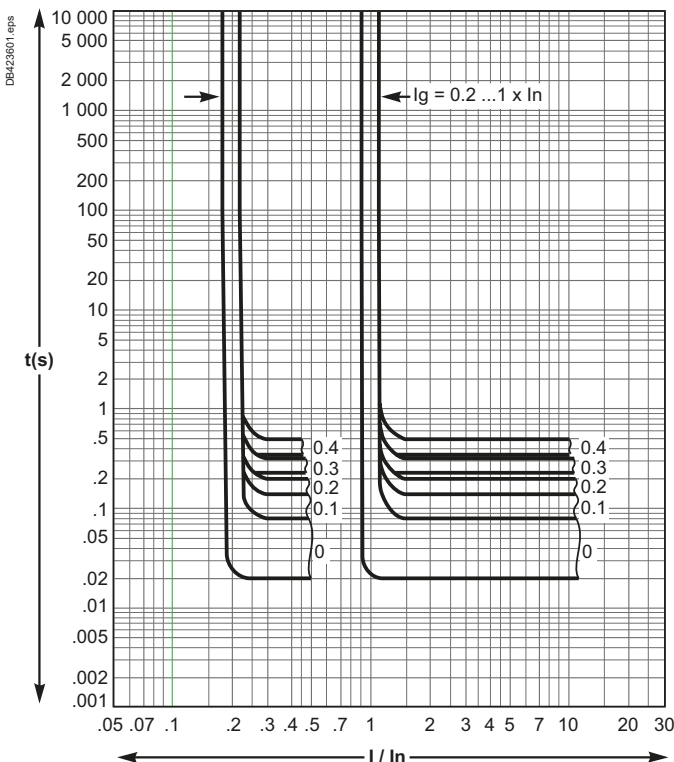

Tripping Curves ComPacT NSXm and NSX Reflex Tripping

ComPacT NSXm and NSX100 to 630 devices incorporate the exclusive reflex-tripping system. This system breaks very high fault currents. The device is mechanically tripped via a "piston" actuated directly by the pressure produced in the breaking units by the short-circuit. For high short-circuits, this system provides a faster break, thereby ensuring selectivity. Reflex-tripping curves are exclusively a function of the circuit-breaker rating.

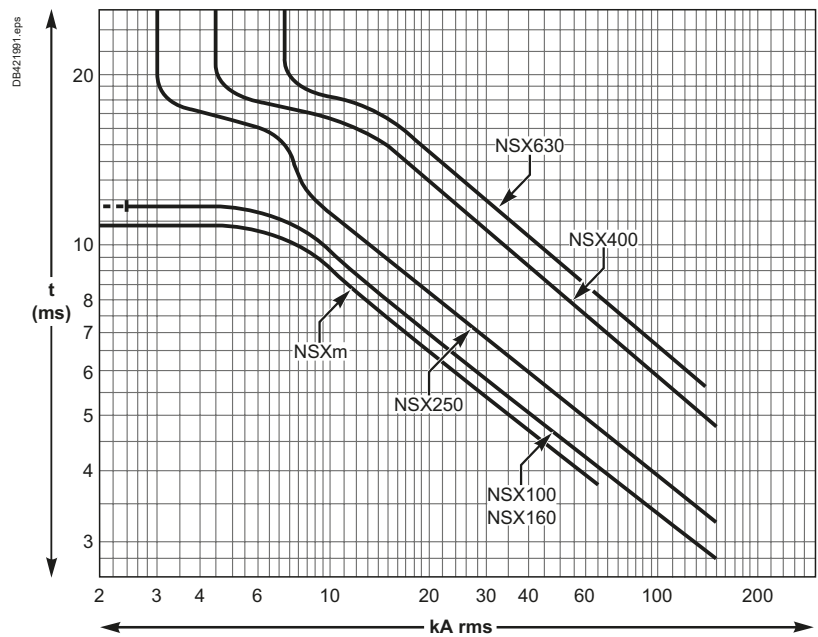

The limiting capacity of a circuit breaker is its aptitude to let through a current, during a short-circuit, that is less than the prospective short-circuit current.

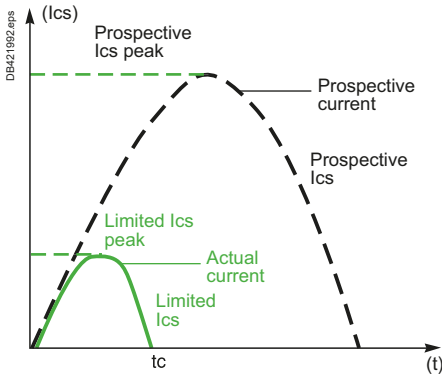

The exceptional limiting capacity of the ComPacT range is due to the rotating double-break technique (very rapid natural repulsion of contacts and the appearance of two arc voltages in-series with a very steep wave front).

> [Selectivity, Cascading and Coordination Guide, Complementary Technical Information](#)



LVPED318033EN

Ics = 100 % Icu

The exceptional limiting capacity of the ComPacT NSX and NSXm ranges greatly reduces the forces created by fault currents in devices. The result is a major increase in breaking performance. In particular, the service breaking capacity Ics is equal to 100 % of Icu. The Ics value, defined by IEC standard 60947-2, is guaranteed by tests comprising the following steps:

- Break three times consecutively a fault current equal to 100 % of Icu
- Check that the device continues to function normally, that is:
 - It conducts the rated current without abnormal temperature rise
 - Protection functions perform within the limits specified by the standard
 - Suitability for isolation is not impaired.

Longer service life of electrical installations

Current-limiting circuit breakers greatly reduce the negative effects of short-circuits on installations.

Thermal effects

Less temperature rise in conductors, therefore longer service life for cables.

Mechanical effects

Reduced electrodynamic forces, therefore less risk of electrical contacts or busbars being deformed or broken.

Electromagnetic effects

Fewer disturbances for measuring devices located near electrical circuits.

Economy by means of cascading

Cascading is a technique directly derived from current limiting. Circuit breakers with breaking capacities less than the prospective short-circuit current may be installed downstream of a limiting circuit breaker. The breaking capacity is reinforced by the limiting capacity of the upstream device. It follows that substantial savings can be made on downstream equipment and enclosures.

Nevertheless, the following limitation curves cannot be used to estimate cascading performance of two circuit-breakers. Reinforced breaking capacity is provided in cascading tables of the "Selectivity, Cascading and Coordination Guide".

Current and energy limiting curves

The limiting capacity of a circuit breaker is expressed by two curves which are a function of the prospective short-circuit current (the current which would flow if no protection devices were installed):

- The actual peak current (limited current)
- Thermal stress (A²s), i.e. the energy dissipated by the short-circuit in a conductor with a resistance of 1 Ω.

Example

What is the real value of a 70 kA rms prospective short-circuit (i.e. 154 kA peak) limited by an NSXm160H upstream ?
The answer is 20 kA peak.

Maximum permissible cable stresses

The table below indicates the maximum permissible thermal stresses for cables depending on their insulation, conductor (Cu or Al) and their cross-sectional area (CSA). CSA values are given in mm² and thermal stresses in A²s.

CSA		1.5 mm ²	2.5 mm ²	4 mm ²	6 mm ²	10 mm ²
PVC	Cu	2.97x10 ⁴	8.26x10 ⁴	2.12x10 ⁵	4.76x10 ⁵	1.32x10 ⁶
	Al					5.41x10 ⁵
PRC	Cu	4.10x10 ⁴	1.39x10 ⁵	2.92x10 ⁵	6.56x10 ⁵	1.82x10 ⁶
	Al					7.52x10 ⁵
CSA		16 mm ²	25 mm ²	35 mm ²	50 mm ²	
PVC	Cu	3.4x10 ⁶	8.26x10 ⁶	1.62x10 ⁷	3.31x10 ⁷	
	Al	1.39x10 ⁶	3.38x10 ⁶	6.64x10 ⁶	1.35x10 ⁷	
PRC	Cu	4.69x10 ⁶	1.39x10 ⁷	2.23x10 ⁷	4.56x10 ⁷	
	Al	1.93x10 ⁶	4.70x10 ⁶	9.23x10 ⁶	1.88x10 ⁷	

Example

Is a Cu/PVC cable with a CSA of 10 mm² adequately protected by an NSX160F? The table above indicates that the permissible stress is 1.32x10⁶ A²s. All short-circuit currents at the point where an NSX160F (Icu = 35 kA) is installed are limited with a thermal stress less than 6x10⁵ A²s. Cable protection is therefore ensured up to the limit of the breaking capacity of the circuit breaker.

Current and Energy Limiting Curves

ComPacT NSXm

Current-limiting curves

Voltage 400/440 V AC

Limited short-circuit current (kA peak)

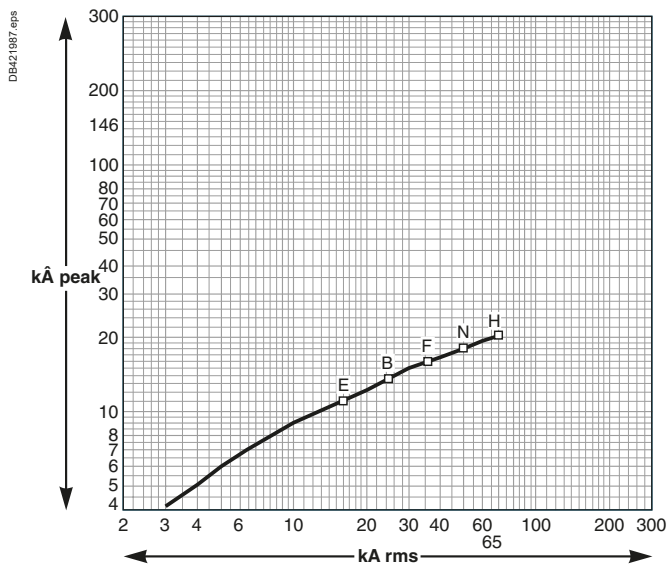

Voltage 660/690 V AC

Limited short-circuit current (kA peak)

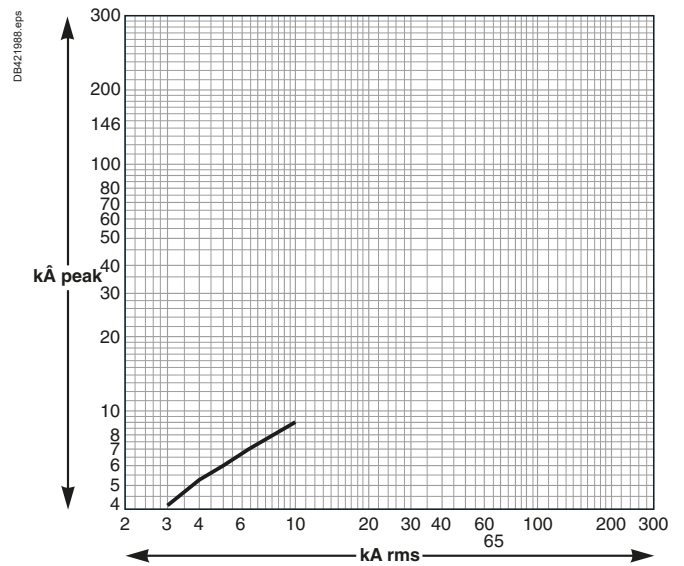

Energy-limiting curves

Voltage 400/440 V AC

Limited energy

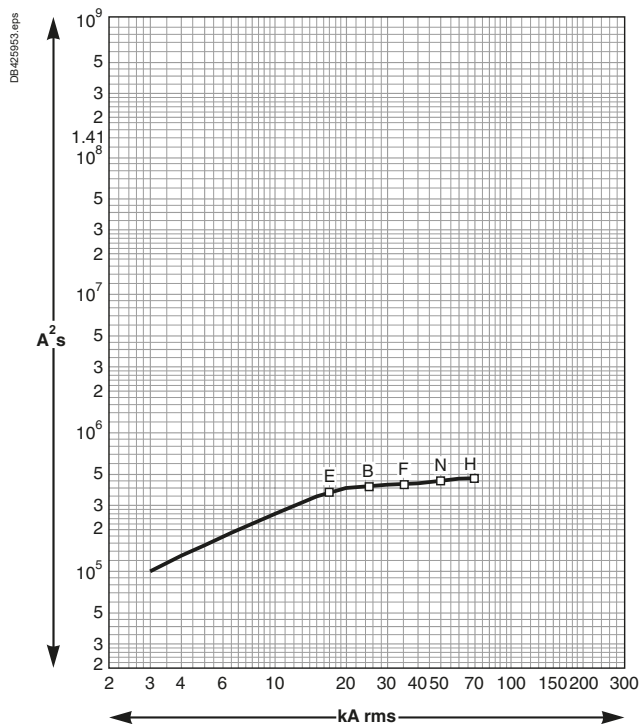

Voltage 660/690 V AC

Limited energy

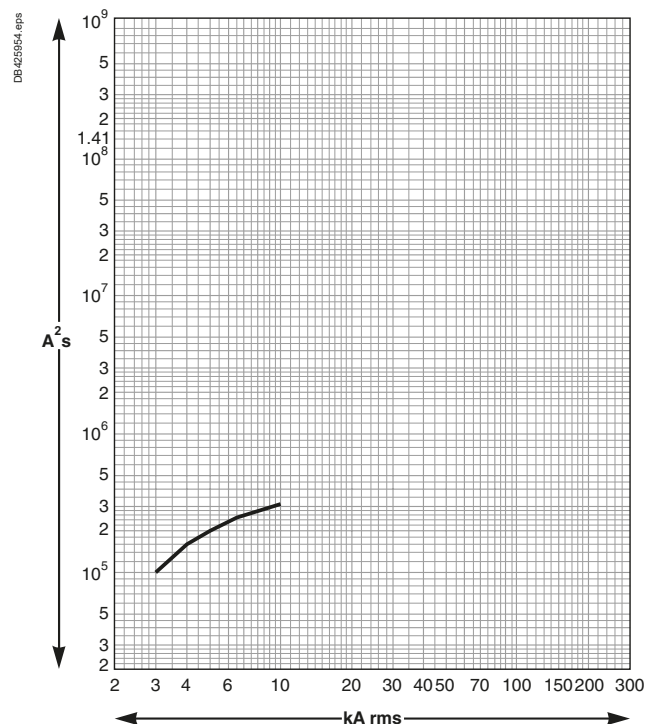

H

Additional Characteristics

Current and Energy Limiting Curves

ComPacT NSX

Current-limiting curves

Voltage 400/440 V AC

Limited short-circuit current (kA peak)

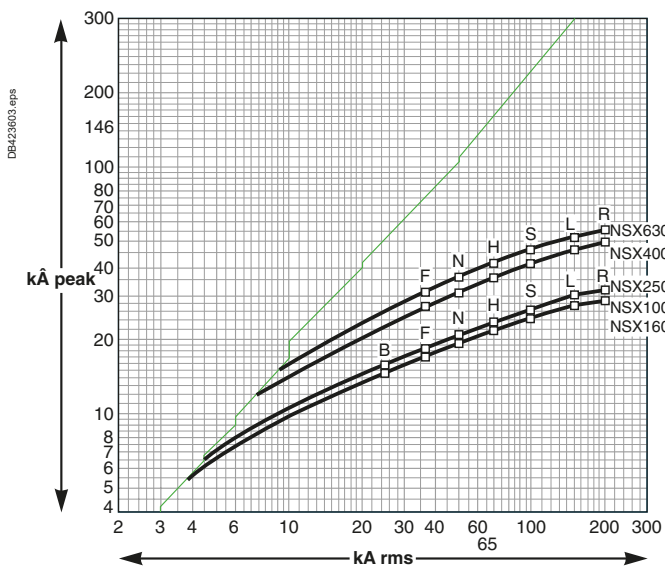

Voltage 660/690 V AC

Limited short-circuit current (kA peak)

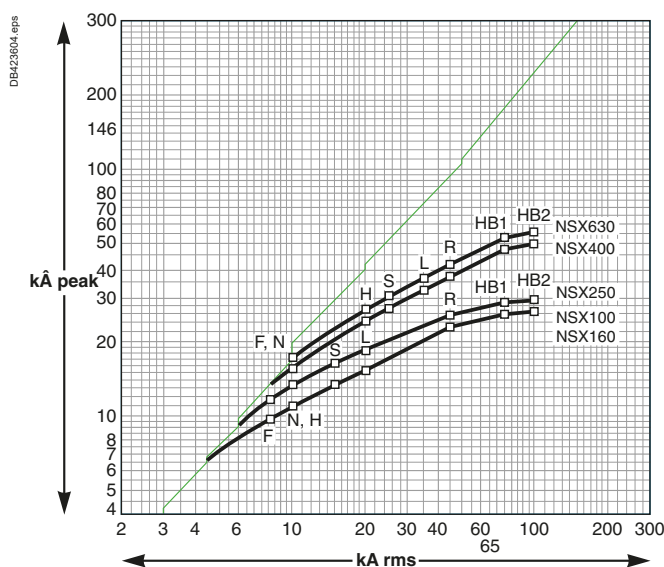

Energy-limiting curves

Voltage 400/440 V AC

Limited energy

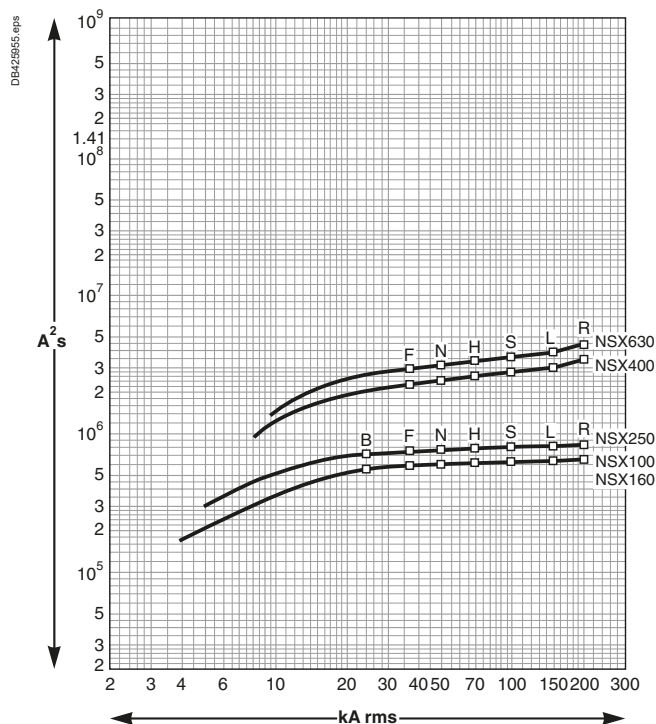

Voltage 660/690 V AC

Limited energy

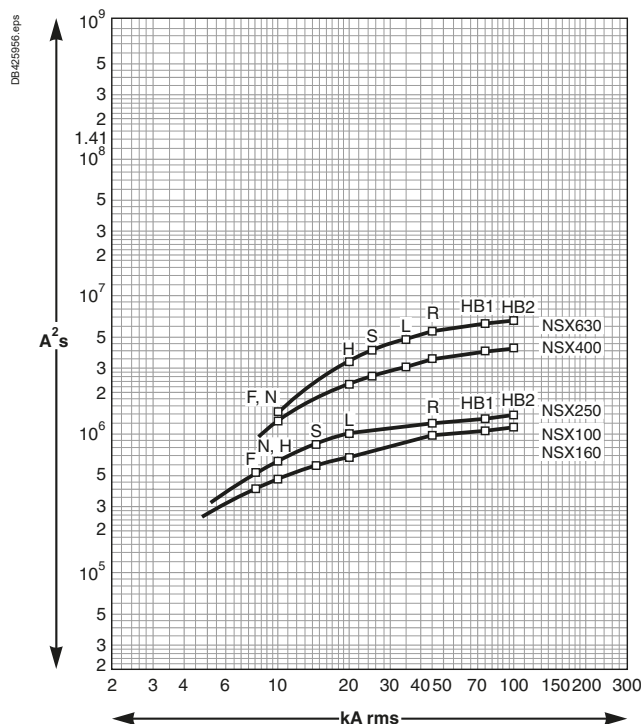

Notes

H

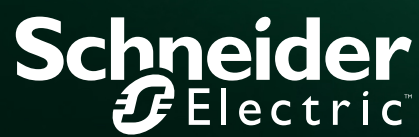

Schneider Electric Industries SAS

35, rue Joseph Monier
CS 30323
92506 Rueil Malmaison Cedex
France

RCS Nanterre 954 503 439
Capital social 928 298 512 €
www.se.com

03/2026

© 2026 - Schneider Electric. All Rights Reserved.
All trademarks are owned by Schneider Electric Industries SAS or its affiliated companies.
Document reference: LVPED221001EN

Advancing
Energy Tech