

Altivar Soft Starter ATS480

User Manual

NNZ85515.06
01/2026



Legal Information

The information provided in this document contains general descriptions, technical characteristics and/or recommendations related to products/solutions.

This document is not intended as a substitute for a detailed study or operational and site-specific development or schematic plan. It is not to be used for determining suitability or reliability of the products/solutions for specific user applications. It is the duty of any such user to perform or have any professional expert of its choice (integrator, specifier or the like) perform the appropriate and comprehensive risk analysis, evaluation and testing of the products/solutions with respect to the relevant specific application or use thereof.

The Schneider Electric brand and any trademarks of Schneider Electric SE and its subsidiaries referred to in this document are the property of Schneider Electric SE or its subsidiaries. All other brands may be trademarks of their respective owner.

This document and its content are protected under applicable copyright laws and provided for informative use only. No part of this document may be reproduced or transmitted in any form or by any means (electronic, mechanical, photocopying, recording, or otherwise), for any purpose, without the prior written permission of Schneider Electric.

Schneider Electric does not grant any right or license for commercial use of the document or its content, except for a non-exclusive and personal license to consult it on an "as is" basis.

Schneider Electric reserves the right to make changes or updates with respect to or in the content of this document or the format thereof, at any time without notice.

To the extent permitted by applicable law, no responsibility or liability is assumed by Schneider Electric and its subsidiaries for any errors or omissions in the informational content of this document, as well as any non-intended use or misuse of the content thereof.

Table of Contents

Safety Information.....	7
About The Document	9
Software Enhancements.....	17
Soft Starter Overview	18
Inspect, Store and Handle the Product.....	19
Inspecting the Product	20
Storage and Shipping	21
Installation.....	23
Electronic product data sheet	24
Unpacking and Handling	25
Weight And Lifting Lugs Availability	26
Unpacking and Hoisting the References on Pallet.....	26
Soft Starter Mounting	28
Before you Begin	29
Mounting in an Enclosure	29
Mounting Position	31
Soft Starter Cooling and Power Dissipation.....	32
Dimensions.....	33
Mounting display terminal on the door of the enclosure	36
Protective Covers For ATS480C41Y...M12Y	37
Fieldbus Modules	39
Wiring.....	40
Power Terminals.....	43
Wiring the Power Part for ATS480D17Y...ATS480C11Y	44
Wiring the Power Part for ATS480C14Y...ATS480M12Y	47
Connection Of The Motor and Supply Mains	50
Control Terminals	52
Control Terminals Layout.....	53
Control Block Wiring Diagram	54
Control Terminal Characteristics.....	54
RUN and STOP Management.....	56
Relay Contacts Wiring.....	58
Application Diagrams	61
Types of coordination.....	69
Checking Installation	70
Cybersecurity.....	72
Overview	73
Security Policy.....	77
Product Defense-in-Depth	78
ATS480 Security Policy	80
Potential Risks and Compensating Controls.....	83
Data Flow Restriction	84
Password.....	85
Security Event Logging	87
Upgrades Management.....	89
Clear Device / Secure Decommissioning	90

Commissioning.....	91
Software and Tools	92
Product HMI.....	93
Display Terminals.....	94
Front Product LEDs.....	98
Soft Starter State	99
First Power-Up	100
Structure of the Parameter Table	105
Finding a Parameter in This Document.....	106
Main Menu Presentation	107
[Simply Start] SYS	108
Set The Currents	109
Set The Mains Voltage	111
Set Start Profile	112
Set Stop Profile.....	113
Example Of Typical Configurations For Common Applications.....	116
Small Motor Test.....	117
Connection Inside The Delta Of The Motor	119
Diagnostic Of The Delta Connection	120
Motor Preheating	123
Torque / Voltage Control.....	128
Voltage Boost.....	129
Second Motor Parameters.....	131
Cascade Motors	134
Smoke Extraction	136
Factory Settings and Customer Configuration	138
HMI navigation	141
1 [Simply Start] SYS	142
2 [Monitoring] PROT	143
2.2 [Process underload] ULD	150
2.4 [Process overload] OLD	152
2.11 [Thermal monitoring] TPP	153
3 [Complete settings] CST	157
3.1 [Motor parameters] MPA	158
3.2 [Mains contactor cmd] LLC	160
3.3 [Motor wiring] MWMT	161
3.4 [Preheating] PRF	163
3.5 [Start & Stop] SSP	165
3.6 [Cascade] CSC	172
3.7 [Smoke Extraction] SMOE	174
3.8 [Command channel] CCP	175
3.9 [Error/Warn handling] CSWM	178
4 [Input/Output] IO	183
4.1 [DI3 assignment] L3A 4.2 [DI4 assignment] L4A	184
4.3 [DQ1 configuration] DO1	185
4.4 [DQ2 Configuration] DO2	186
4.5 [AI1 configuration] AI1	187
4.6 [AQ1 configuration] AO1	188
4.7 [R1 configuration] R1	191
4.9 [R3 configuration] R3	192
5 [2nd Mot Parameters] ST2	194

6 [Communication] COM	195
6.1 [Modbus Fieldbus] MD1	196
[Com. scanner input] ICS	198
[Com. scanner output] OCS	199
6.2 [Eth Module Config] ETO	200
6.3 [CANopen] CNO	200
6.4 [Profibus] PBC	200
6.5 [Profinet] PNC	200
6.6 [Communication map] CMM	201
7 [Display] MON	209
7.1 [Motor parameters] MMO	210
7.2 [Thermal Monitoring] TPM	212
7.3 [Counter Management] ELT	213
7.4 [Other State] SST	214
7.5 [I/O Map] IOM	215
7.6 [Energy parameters] ENP	218
8 [Diagnostics] DIA	219
8.1 [Diag. data] DDT	220
8.2 [Error history] PFH	221
8.3 [Warnings] ALR	222
9 [Device Management] DMT	223
9.1 [Device Name] PAN	224
9.2 [Identification] OID	224
9.3 [Transfer config file] TCF	225
9.4 [Factory settings] FCS	226
9.5 [Backup/Restore] BRDV	228
9.6 [Cybersecurity] CYBS	229
9.7 [Date & Time] DTO	232
9.8 [Firmware update] FWUP	234
9.11 [Simulation mode] SIMU	237
9.12 [Product restart] RP	238
10 [My preferences] MYP	239
10.1 [Language] LNG	240
10.2 [Parameter access] PAC	241
10.3 [Customization] CUS	242
[Display screen type] MSC	243
[Service Message] SER	244
10.4 [LCD settings] CNL	244
10.5 [QR code] QCC	245
Functions Compatibility Table	246
Diagnostics and Troubleshooting	248
Troubleshooting	249
Warning messages and error codes	251
Maintenance	271
Soft Starter, Display Terminals and Fieldbus Modules Update	272
Scheduled Servicing	274
Real Time Clock (RTC)	278
Decommissioning	279
Additional Support	280
Technical Data	282

Environment Data.....	283
Difference between Normal and Heavy duty	284
ATS480 and Motor Combination	285
Mains Supply in Function of the System Earthing Arrangement According to the Altitude.....	286
Normal Duty, Soft Starter In Line Connection, 208...690 Vac 50/60 Hz Supply	287
Normal Duty, Soft Starter Inside Delta Connection, 230...415 Vac 50/ 60 Hz Supply	288
Heavy Duty, Soft Starter In Line Connection, 208...690 Vac 50/60 Hz Supply	289
Heavy Duty, Soft Starter Inside Delta Connection, 230...415 Vac 50/ 60 Hz Supply	290
Soft Starter Thermal Monitoring	291
Glossary	293

Safety Information

Important Information

Read these instructions carefully, and look at the equipment to become familiar with the device before trying to install, operate, service, or maintain it. The following special messages may appear throughout this documentation or on the equipment to warn of potential hazards or to call attention to information that clarifies or simplifies a procedure.



The addition of this symbol to a “Danger” or “Warning” safety label indicates that an electrical hazard exists which will result in personal injury if the instructions are not followed.



This is the safety alert symbol. It is used to alert you to potential personal injury hazards. Obey all safety messages that follow this symbol to avoid possible injury or death.

DANGER

DANGER indicates a hazardous situation which, if not avoided, **will result in death or serious injury**.

WARNING

WARNING indicates a hazardous situation which, if not avoided, **could result in death or serious injury**.

CAUTION

CAUTION indicates a hazardous situation which, if not avoided, **could result in minor or moderate injury**.

NOTICE

NOTICE is used to address practices not related to physical injury.

Please Note

Electrical equipment should be installed, operated, serviced, and maintained only by qualified personnel. No responsibility is assumed by Schneider Electric for any consequences arising out of the use of this material.

A qualified person is one who has skills and knowledge related to the construction and operation of electrical equipment and its installation, and has received safety training to recognize and avoid the hazards involved.

Qualification of Personnel

Only appropriately trained persons who are familiar with and understand the contents of this manual and all other pertinent product documentation are authorized to work on and with this product. In addition, these persons must have received safety training to recognize and avoid hazards involved. These persons must have sufficient technical training, knowledge and experience and be able to foresee and detect potential hazards that may be caused by using the product, by changing the settings and by the mechanical, electrical and electronic equipment of the entire system in which the product is used. All persons working on and with the product must be fully familiar with all applicable standards, directives, and accident prevention regulations when performing such work.

Intended Use

This product is intended for industrial use according to this manual.

The product may only be used in compliance with all applicable safety standard and local regulations and directives, the specified requirements and the technical data. The product must be installed outside the hazardous ATEX zone. Prior to using the product, you must perform a risk assessment in view of the planned application. Based on the results, the appropriate safety measures must be implemented. Since the product is used as a component in an entire system, you must ensure the safety of persons by means of the design of this entire system (for example, machine design). Any use other than the use explicitly permitted is prohibited and can result in hazards.

About The Document

Document scope

The purpose of this document is:

- to give mechanical and electrical information related to the Altivar Soft Starter ATS480.
- to show how to install, wire and program this soft starter.

Validity note

Original instructions and information given in the present document have been written in English (before optional translation).

NOTE: The products listed in the document are not all available at the time of publication of this document online. The data, illustrations and product specifications listed in the guide will be completed and updated as the product availabilities evolve. Updates to the guide will be available for download once products are released onto the market.

This documentation is valid only for ATS480.

The characteristics that are presented in this manual should be the same as those characteristics that appear online. In line with our policy of constant improvement, we may revise content over time to improve clarity and accuracy. If you see a difference between the manual and online information, use the online information as your reference.

Product related information

Read and understand these instructions before performing any procedure with this soft starter.

DANGER

HAZARD OF ELECTRIC SHOCK, EXPLOSION, OR ARC FLASH

- Only appropriately trained persons who are familiar with and fully understand the contents of the present manual and all other pertinent product documentation and who have received all necessary training to recognize and avoid hazards involved are authorized to work on and with this equipment.
- Installation, adjustment, repair and maintenance must be performed by qualified personnel.
- Verify compliance with all local and national electrical code requirements as well as all other applicable regulations with respect to grounding of all equipment.
- Only use properly rated, electrically insulated tools and measuring equipment.
- Do not touch unshielded components or terminals with voltage present.
- Prior to performing any type of work on the equipment, block the motor shaft to prevent rotation.
- Insulate both ends of unused conductors of the motor cable.

Failure to follow these instructions will result in death or serious injury.

DANGER

HAZARD OF ELECTRIC SHOCK, EXPLOSION, OR ARC FLASH

Before performing work on the equipment:

- Use all required personal protective equipment (PPE).
- Disconnect all power, including external control power that may be present. Take into account that the circuit breaker or main switch does not de-energize all circuits.
- Place a "Do Not Turn On" label on all power switches related to the equipment.
- Lock all power switches in the open position.
- Verify the absence of voltage using a properly rated voltage sensing device.

Before applying voltage to the equipment:

- Verify that the work has been completed and that the entire installation cannot cause hazards.
- If the mains input terminals and the motor output terminals have been grounded and short-circuited, remove the ground and the short circuits on the mains input terminals and the motor output terminals.
- Verify proper grounding of all equipment.
- Verify that all protective equipment such as covers, doors, grids is installed and/or closed.

Failure to follow these instructions will result in death or serious injury.

DANGER

HAZARD OF ELECTRIC SHOCK, EXPLOSION, OR ARC FLASH

- Never operate energized switch with door open.
- Turn off switch before removing or installing fuses or making load side connections.
- Do not use renewable link fuses in fused switches.

Failure to follow these instructions will result in death or serious injury.

Damaged products or accessories may cause electric shock or unanticipated equipment operation.

DANGER

ELECTRIC SHOCK OR UNANTICIPATED EQUIPMENT OPERATION

Do not use damaged products or accessories.

Failure to follow these instructions will result in death or serious injury.

Contact your local Schneider Electric sales office if you detect any damage whatsoever.

This equipment has been designed to operate outside of any hazardous location. Only install this equipment in zones known to be free of a hazardous atmosphere.

DANGER

POTENTIAL FOR EXPLOSION

Install and use this equipment in non-hazardous locations only.

Failure to follow these instructions will result in death or serious injury.

Your application consists of a whole range of different interrelated mechanical, electrical, and electronic components, the device being just one part of the application. The device by itself is neither intended to nor capable of providing the entire functionality to meet all safety-related requirements that apply to your application. Depending on the application and the corresponding risk assessment to be conducted by you, a whole variety of additional equipment is required such as, but not limited to, external monitoring devices, guards, etc.

As a designer/manufacturer of machines, you must be familiar with and observe all standards that apply to your machine. You must conduct a risk assessment and determine the appropriate Performance Level (PL) and/or Safety Integrity Level (SIL) and design and build your machine in compliance with all applicable standards. In doing so, you must consider the interrelation of all components of the machine. In addition, you must provide instructions for use that enable the user of your machine to perform any type of work on and with the machine such as operation and maintenance in a safe manner.

The present document assumes that you are fully aware of all normative standards and requirements that apply to your application. Since the device cannot provide all safety-related functionality for your entire application, you must ensure that the required Performance Level and/or Safety Integrity Level is reached by installing all necessary additional equipment.

▲ WARNING

INSUFFICIENT PERFORMANCE LEVEL/SAFETY INTEGRITY LEVEL AND/OR UNINTENDED EQUIPMENT OPERATION

- Conduct a risk assessment according to EN ISO 12100 and all other standards that apply to your application.
- Use redundant components and/or control paths for all critical control functions identified in your risk assessment.
- Verify that the service life of all individual components used in your application is sufficient for the intended service life of your overall application.
- Perform extensive commissioning tests for all potential error situations to verify the effectiveness of the safety-related functions and monitoring functions implemented, for example, but not limited to, speed monitoring by means of encoders, short circuit monitoring for all connected equipment, correct operation of brakes and guards.
- Perform extensive commissioning tests for all potential error situations to verify that the load can be brought to a safe stop under all conditions.

Failure to follow these instructions can result in death, serious injury, or equipment damage.

Product may perform unexpected movements because of incorrect wiring, incorrect settings, incorrect data or other errors.

▲ WARNING

UNANTICIPATED EQUIPMENT OPERATION

- Carefully install the wiring in accordance with the EMC requirements.
- Do not operate the product with unknown or unsuitable settings or data.
- Perform a comprehensive commissioning test.

Failure to follow these instructions can result in death, serious injury, or equipment damage.

⚠ WARNING

LOSS OF CONTROL

- The designer of any control scheme must consider the potential failure modes of control paths and, for critical control functions, provide a means to achieve a safe state during and after a path failure. Examples of critical control functions are emergency stop, overtravel stop, power outage and restart.
- Separate or redundant control paths must be provided for critical control functions.
- System control paths may include communication links. Consideration must be given to the implications of unanticipated transmission delays or failures of the link.
- Observe all accident prevention regulations and local safety guidelines (1).
- Each implementation of the product must be individually and thoroughly tested for proper operation before being placed into service.

Failure to follow these instructions can result in death, serious injury, or equipment damage.

(1) For USA: Additional information, refer to NEMA ICS 1.1 (latest edition), Safety Guidelines for the Application, Installation and Maintenance of Solid State Control.

Machines, controllers, and related equipment are usually integrated into networks. Unauthorized persons and malware may gain access to the machine as well as to other devices on the network/fieldbus of the machine and connected networks via insufficiently secure access to software and networks.

⚠ WARNING

UNAUTHORIZED ACCESS TO THE MACHINE VIA SOFTWARE AND NETWORKS

- In your hazard and risk analysis, consider all hazards that result from access to and operation on the network/fieldbus and develop an appropriate cybersecurity concept.
- Verify that the hardware infrastructure and the software infrastructure into which the machine is integrated as well as all organizational measures and rules covering access to this infrastructure consider the results of the hazard and risk analysis and are implemented according to best practices and standards covering IT security and cybersecurity (such as: ISO/IEC 27000 series, Common Criteria for Information Technology Security Evaluation, ISO/IEC 15408, IEC 62351, ISA/IEC 62443, NIST Cybersecurity Framework, Information Security Forum - Standard of Good Practice for Information Security, SE recommended Cybersecurity Best Practices*).
- Verify the effectiveness of your IT security and cybersecurity systems using appropriate, proven methods.

Failure to follow these instructions can result in death, serious injury, or equipment damage.

(*) : SE Recommended Cybersecurity Best Practices can be downloaded on SE.com.

⚠ WARNING

LOSS OF CONTROL

Perform a comprehensive commissioning test to verify that communication monitoring properly detects communication interruptions.

Failure to follow these instructions can result in death, serious injury, or equipment damage.

This product meets the EMC requirements according to the standard IEC 60947-4-2. This device has been designed for environment A. Use of this product in a domestic environment (B environment) may cause unwanted radio interference.

⚠ WARNING

RADIO INTERFERENCE

- In a domestic environment (B environment), this product may cause radio interference in which case supplementary mitigation measures may be required.
- The references from ATS480D17Y to ATS480C11Y can be adapted to a domestic environment (B environment) by adding an external bypass contactor. For other ATS480 references, you must consider other mitigation measures.

Failure to follow these instructions can result in death, serious injury, or equipment damage.

NOTICE

DESTRUCTION DUE TO INCORRECT MAINS VOLTAGE

Before switching on and configuring the product, verify that it is approved for the mains voltage.

Failure to follow these instructions can result in equipment damage.

General Cybersecurity Information

In recent years, the growing number of networked machines and production plants has seen a corresponding increase in the potential for cyber threats, such as unauthorized access, data breaches, and operational disruptions. You must, therefore, consider all possible cybersecurity measures to help protect assets and systems against such threats.

To help keep your Schneider Electric products secure and protected, it is in your best interest to implement the cybersecurity best practices as described in the *Cybersecurity Best Practices* document.

Schneider Electric provides additional information and assistance:

- [Subscribe to the Schneider Electric security newsletter.](#)
- [Visit the Cybersecurity Support Portal web page to:](#)
 - [Find Security Notifications.](#)
 - [Report vulnerabilities and incidents.](#)
- [Visit the Schneider Electric Cybersecurity and Data Protection Posture web page to:](#)
 - [Access the cybersecurity posture.](#)
 - [Learn more about cybersecurity in the cybersecurity academy.](#)
 - [Explore the cybersecurity services from Schneider Electric.](#)

Environmental Data

The Environmental Data Program is a framework for how we measure, categorize, and compare the environmental attributes and footprint of our products.

Using a rigorous, fact-based methodology, the program provides environmental data from across the product lifecycle.

Five data categories across the product lifecycle

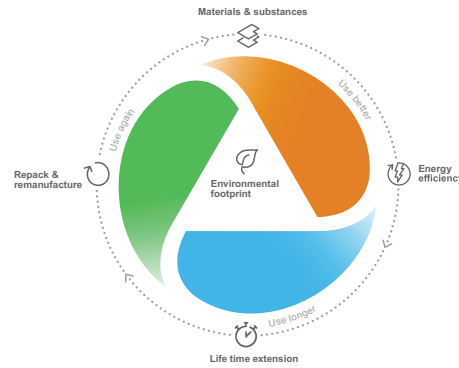

Use Better: How sustainable a product is, including environmental footprint, materials and substances, packaging, and energy efficiency.

Use Longer: How a product's life time can be effectively extended in terms of reparability and updatability.

Use Again: How a product can be reused, from dismantling and remanufacturing to recyclability and manufacturer take back.

With this transparent, verified data, customers and partners are empowered to make conscious environmental choices and accurately evaluate and report on sustainability performance.

All our hardware offers have an associated environmental data available on se.com product pages.

Refer to Environmental Data Program for more information.

Related Documents

Use your tablet or your PC to quickly access detailed and comprehensive information on all our products on www.se.com The Internet site provides the information you need for products and solutions:

- The whole catalog for detailed characteristics and selection guides
- The CAD files to help design your installation, available in over 20 different file formats
- All software and firmware to maintain your installation up to date
- A large quantity of White Papers, Environment documents, Application solutions, Specifications... to gain a better understanding of our electrical systems and equipment or automation
- And finally all the User Guides related to your soft starter, listed below:

You can download there technical publications and other technical information from our website at www.se.com/en/download.

Catalog

Title of documentation	Reference number
Catalog: Altivar Soft Starter ATS480	DIA2ED2210602EN (English)
	DIA2ED2210602FR (French)
	ECATA1172 (Chinese)
	DIA2ED2210602DE (German)

Documentations

Title of documentation	Reference number
ATS480 Getting Started Manual	NNZ85504 (English), NNZ85505 (French) NNZ85506 (Spanish), NNZ85507 (Italian) NNZ85508 (German), NNZ85509 (Chinese) NNZ85510 (Portuguese), NNZ85511 (Turkish)
ATS480 Getting Started Manual Annex for UL	NNZ86539 (English)
ATS480 User Manual	NNZ85515 (English), NNZ85516 (French) NNZ85517 (Spanish), NNZ85518 (Italian) NNZ85519 (German), NNZ85520 (Chinese) NNZ85521 (Portuguese), NNZ85522 (Turkish)
ATS480 Embedded Modbus RTU Manual	NNZ85539 (English)
ATS480 EtherNet/IP – Modbus TCP Manual	NNZ85540 (English)
ATS480 PROFIBUS DP Manual	NNZ85542 (English)
ATS480 Profinet Manual	NNZ85541 (English)
ATS480 CANopen Manual	NNZ85543 (English)
ATS480 Communication Parameter Addresses	NNZ85544 (English)
ATS480 Cascade Function Application Note	NNZ85564 (English)
Recommended Cybersecurity Best Practices	CS-Best-Practices-2019–340 (English)

ATS48 to ATS480 substitution

Title of documentation	Reference number
ATS48 to ATS480 Substitution Manual	NNZ85529 (English), NNZ85530 (French) NNZ85531 (Spanish), NNZ85532 (Italian) NNZ85533 (German), NNZ85534 (Chinese) NNZ85535 (Portuguese), NNZ85536 (Turkish)
Video: How to substitute an ATS48 for an ATS480?	FAQ000210049 (English)

Videos

Title of documentation	Reference number
Getting Started with ATS480	FAQ000233342 (English)
How to update the firmware on ATS480 with EcoStruxure Automation Device Maintenance?	FAQ000233943 (English)
How to configure the cybersecurity applied to ATS480?	FAQ000236206 (English)
How to Integrate ATS480 DFB with EcoStruxure Control Expert	FAQ000244312 (English)

Software

Title of documentation	Reference number
SoMove: FDT	SoMove FDT (English, French, German, Spanish, Italian, Chinese)
ATS480: DTM	ATS480 DTM Library EN (English – to be installed first) ATS480 DTM Lang FR (French) ATS480 DTM Lang SP (Spanish) ATS480 DTM Lang IT (Italian) ATS480 DTM Lang DE (German) ATS480 DTM Lang CN (Chinese)
EcoStruxure Automation Device Maintenance	EADM (English)

Terminology used in this document

The technical terms, terminology, and the corresponding descriptions in this manual normally use the terms or definitions in the relevant standards.

In the area of soft starters this includes, but is not limited to, terms such as **error**, **error message**, **failure**, **fault**, **fault reset**, **protection**, **safe state**, **safety function**, **warning**, **warning message**, and so on.

Among others, these standards include:

- ISO 13849-1 & 2 Safety of machinery - safety related parts of control systems
- IEC 61158 series: Industrial communication networks - Fieldbus specifications
- IEC 61784 series: Industrial communication networks - Profiles
- IEC 60204-1: Safety of machinery - Electrical equipment of machines – Part 1: General requirements
- IEC 60947–1 Low–Voltage Switchgear and Control Gear – General rules
- IEC 60947–4-2 Semiconductor Motor controllers, Starters and Soft Starters
- IEC 62443: Security for industrial automation and control systems

In addition, the term **zone of operation** is used in conjunction with the description of specific hazards, and is defined as it is for a **hazard zone** or **danger zone** in the EC Machinery Directive (2006/42/EC) and in ISO 12100.

Also see the glossary at the end of this manual.

Contact us

Select your country on www.se.com/contact.

Schneider Electric Industries SAS

Head Office

35, rue Joseph Monier

92500 Rueil-Malmaison

France

Software Enhancements

Overview

NOTE: Make sure that the latest version of the software and of the user manual are used.

The Altivar Soft Starter ATS480 will benefit from future software enhancements. Those enhancements will be listed below.

This documentation relates to the version V1.2.

V1.1 Release Note

Initial release.

V1.2 Release Note

- Support of PROFINET option module.
- **[Cust Supply Diag]** **CPSF** new monitoring value.

Soft Starter Overview

ATS480 Catalog Number Description

Catalog number elements	Description
ATS480	Product range, Altivar Soft Starter
D	Factor for current rating: <ul style="list-style-type: none"> • D: current rating x 1 • C: current rating x 10 • M: current rating x 100
17	Current rating: 10 – 11 – 12 – 14 – 17 – 21 – 22 – 25 – 32 – 38 – 41 – 47 – 48 – 59 – 62 – 66 – 75 – 79 – 88
Y	Power part supply: Y = 208...690 Vac

Frame Sizes

Frame Size	Correspondence
A	ATS480D17Y...ATS480D47Y 3-phase 208...690 V, 17...47 A, 2.2...45 kW, 3...50 HP
B	ATS480D62Y...ATS480C11Y 3-phase 208...690 V, 62...110 A, 11...90 kW, 15...125 HP
C	ATS480C14Y...ATS480C17Y 3-phase 208...690 V, 140...170 A, 30...160 kW, 40...200 HP
D	ATS480C21Y...ATS480C32Y 3-phase 208...690 V, 210...320 A, 45...315 kW, 60... 400 HP
E	ATS480C41Y...ATS480C66Y 3-phase 208...690 V, 410...660 A, 90...630 kW, 125...850 HP
F	ATS480C79Y...ATS480M12Y 3-phase 208...690 V, 790...1200 A, 220...900 kW, 250...1200 HP

Inspect, Store and Handle the Product

What's in This Part

Inspecting the Product	20
Storage and Shipping	21

Inspecting the Product

Unpack the soft starter and verify that it is not damaged.

Damaged products or accessories may cause electric shock or unanticipated equipment operation.

DANGER

ELECTRIC SHOCK OR UNANTICIPATED EQUIPMENT OPERATION

Do not use damaged products or accessories.

Failure to follow these instructions will result in death or serious injury.

Contact your local Schneider Electric sales office if you detect any damage whatsoever.

Step	Action
1	Verify that the reference number printed on the nameplate corresponds to the purchase order.
2	Before performing any installation work inspect the product for visible damage.

Store the product in its original packaging if not installed immediately after inspection.

Storage and Shipping



NOTICE
<p>INCORRECT STORAGE</p> <p>Do not crush the packaging during transport and storage.</p> <p>Failure to follow these instructions can result in equipment damage.</p>

Refer to the stacking instructions on the packaging. The environment during transportation and storage must be dry and free from dust.

	IEC Standard	Transport and Storage
Ambient temperature		-25...70° C (-13...158 °F)
Relative humidity	IEC 60068–2–3	Maximum 93 % without condensation or dripping water
Vibration resistance	IEC 60068–2–6	<ul style="list-style-type: none"> • 1.75 mm peak to peak from 2 to 13 Hz • 15 m/s² from 13 to 200 Hz • 10 m/s² from 200 to 500 Hz
Shock resistance	IEC 60068–2–27	100 m/s ² (10 g) during 11 ms

For more information refer to [Technical Data](#), page 282.

If the soft starter must be shipped to another location, use the original shipping material.

⚠ WARNING
<p>INCORRECT HANDLING</p> <ul style="list-style-type: none"> • Lifting and handling must be performed by qualified personnel in accordance with the requirements of the site and in compliance with all pertinent regulations. • Verify that there are no persons or obstructions in the area of operation of the lifting and handling equipment. • Use lifting and handling equipment appropriate for the load and take all necessary measures to avoid swinging, inclination, toppling and any other potentially hazardous conditions. • Follow all handling instructions provided in this manual and in all associated product documentation. • Take all measures required to avoid damage to the product and other hazards when handling or opening the packaging. • Handle and store the product in its original packaging. • Do not handle and store the product if the packaging is damaged or appears to be damaged. <p>Failure to follow these instructions can result in death, serious injury, or equipment damage.</p>

To help protect the product before installation, handle and store it in its packaging. Ensure that the specified ambient conditions are followed.

▲ WARNING**SHARP EDGES**

Use all necessary personal protective equipment (PPE) such as gloves when performing any type of work whatsoever on or with this product.

Failure to follow these instructions can result in death, serious injury, or equipment damage.

Installation

What's in This Part

Electronic product data sheet	24
Unpacking and Handling	25
Soft Starter Mounting.....	28
Soft Starter Cooling and Power Dissipation	32
Dimensions.....	33
Mounting display terminal on the door of the enclosure	36
Protective Covers For ATS480C41Y...M12Y	37
Fieldbus Modules	39

Electronic product data sheet

Scan the QR code in front of the soft starter to get the product data sheet.

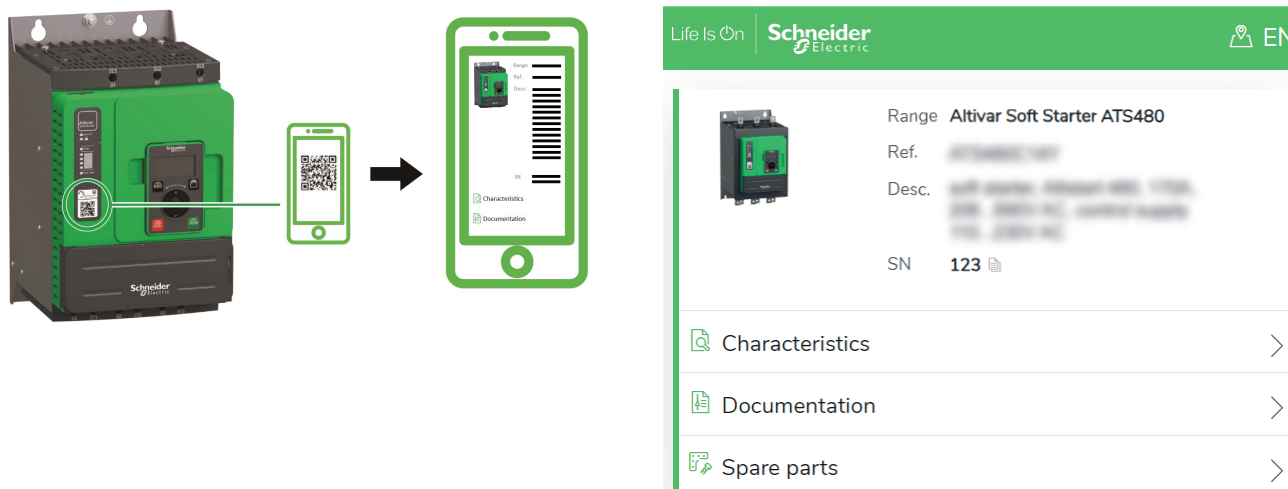

Scanning the QR Code gives you access to :

- Product ID Card : Product range, Reference, short description and a Serial Number (Use the serial number to retrieve the product's manufacturing date).
About the Serial Number, refer to Manufacturing Date, page 281.
- The product characteristics : Main characteristics, environment, packing units, sustainability...
- Documentation : Technical Guidance at Glance (Presentation, Dimensions, Mounting, Wiring, Commissioning...) and Product Documentation (User guide, Instructions sheets, Certificates, How To videos...)
- Spare parts for your product

Unpacking and Handling

What's in This Chapter

Weight And Lifting Lugs Availability.....	26
Unpacking and Hoisting the References on Pallet.....	26

Weight And Lifting Lugs Availability

See the weights, lifting lugs availability and packaging types in the following table before installing the soft starter.

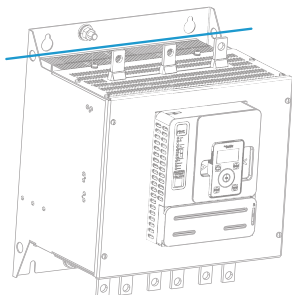

References	Weight kg (lbs)	Lifting lugs	Packaging
ATS480D17Y...D47Y	4.9 (10.8)	No	Cardboard box
ATS480D62Y...C11Y	8.3 (18.2)	No	Cardboard box
ATS480C14Y...C17Y	12.4 (27.3)	Yes	Cardboard box
ATS480C21Y...C32Y	18.2 (40.1)	Yes	Pallet
ATS480C41Y...C66Y	51.4 (113.3)	Yes	Pallet
ATS480C79Y...M12Y	115 (253.5)	Yes	Pallet

Unpacking and Hoisting the References on Pallet

For ATS480C21Y to ATS480M12Y, consider this additional safety message:

⚠ WARNING

TIPPING

- Take into account the high center of gravity when handling the equipment.
- Only transport the equipment on the pallet using a suitable forklift.
- Do not remove the straps and the screws on the pallet before the equipment has been transported to the final installation position.

Failure to follow these instructions can result in death, serious injury, or equipment damage.

⚠ WARNING

SHARP EDGES

Use all necessary personal protective equipment (PPE) such as gloves when performing any type of work whatsoever on or with this product.

Failure to follow these instructions can result in death, serious injury, or equipment damage.

⚠ WARNING

TOPPLING, SWINGING, OR FALLING EQUIPMENT

- Take all measures necessary to keep the equipment from swinging, toppling and falling.
- Follow the instructions provided to remove the equipment from the packaging and to mount it at its final position.

Failure to follow these instructions can result in death, serious injury, or equipment damage.

See the procedure for hoisting the references from ATS480C41Y to ATS480M12Y:

Step	Action
1	Lift the soft starter by means of a hoist by using the handling lugs of the soft starter to fasten the lifting equipment. The lifting bar is not supplied.
2	Keep the soft starter suspended by means of appropriate equipment until it is securely fastened in the final installation position.
3	Move the soft starter to the final installation or on the back of the enclosure in accordance with the instructions given in this document.

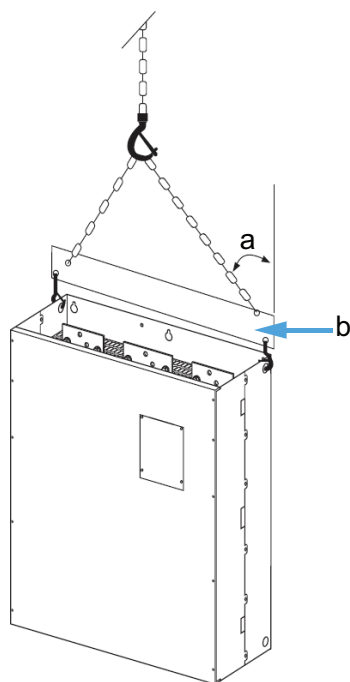

- a: 45° maximum
- b: Lifting bar

Soft Starter Mounting

What's in This Chapter

Before you Begin.....	29
Mounting in an Enclosure.....	29
Mounting Position.....	31

Before you Begin

Conductive foreign objects may cause parasitic voltage.

⚠️⚠️ DANGER

ELECTRIC SHOCK AND/OR UNANTICIPATED EQUIPMENT OPERATION

- Keep foreign objects such as chips, screws or wire clippings from getting into the product.
- Verify correct seat of seals and cable entries in order to avoid deposits and humidity.

Failure to follow these instructions will result in death or serious injury.

The temperature of the products described in this manual may exceed 80 °C (176 °F) during operation.

⚠️ WARNING

HOT SURFACES

- Ensure that any contact with hot surfaces is avoided.
- Do not allow flammable or heat-sensitive parts in the immediate vicinity of hot surfaces.
- Verify that the product has sufficiently cooled down before handling it.
- Verify that the heat dissipation is sufficient by performing a test run under maximum load conditions.

Failure to follow these instructions can result in death, serious injury, or equipment damage.

Mounting in an Enclosure

⚠️⚠️ DANGER

HAZARD OF ELECTRIC SHOCK, EXPLOSION, OR ARC FLASH

These products are open devices and must be mounted in a suitable enclosure.

Failure to follow these instructions will result in death or serious injury.

Use the enclosure manufacturers' specifications for proper sizing based on thermal considerations. It is necessary to add up the power dissipated by each device in the enclosure.

For the power dissipated by the soft starter refer to Soft Starter Cooling and Power Dissipation, page 32.

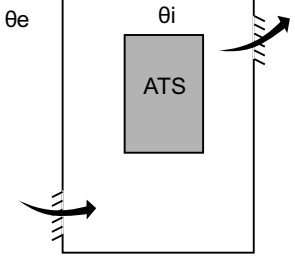
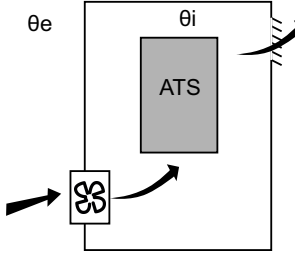
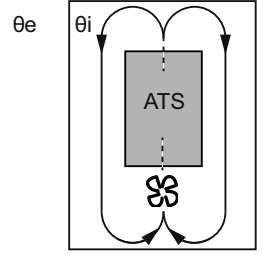
	Enclosure type		
	General purpose metal to reach IP23		Dust and damp-proof metal to reach IP54 / NEMA12
θ_e = external ambient temperature θ_i = internal ambient temperature of the enclosure			
Air circulation	Install air inlet	If air inlet is not adequate, install a forced ventilation unit, with a filter if necessary	<p>Do not use insulated or non-metallic enclosures as they have poor thermal conduction. Provide a stirring fan to circulate air inside the enclosure and to help prevent hot spots in the soft starter.</p> <p>This allows operation of the soft starter in an enclosure with a maximum internal temperature of 60 °C (140 °F)</p>
Temperature around the soft starter	<ul style="list-style-type: none"> -10...40 °C (14...104 °F) without derating when not bypassed -10...50 °C (14...122 °F) without derating when bypassed 40...60 °C (104 ... 140 °F) with rated current (I_e) derating of 2% per degree <p>Ensure that the ambient temperature around the soft starters does not exceed this limit.</p>		

Mounting Position

The soft starter is designed to be mounted inside cabinets vertically at $\pm 10^\circ$ for cooling purposes.

Respect the minimum clearances so that the cooling air can circulate from the bottom to the top of the soft starter. The minimum clearances apply to any device close to the soft starter such as circuit breakers, fuses, contactors, bypass contactors.

Do not install the soft starter above heating elements.

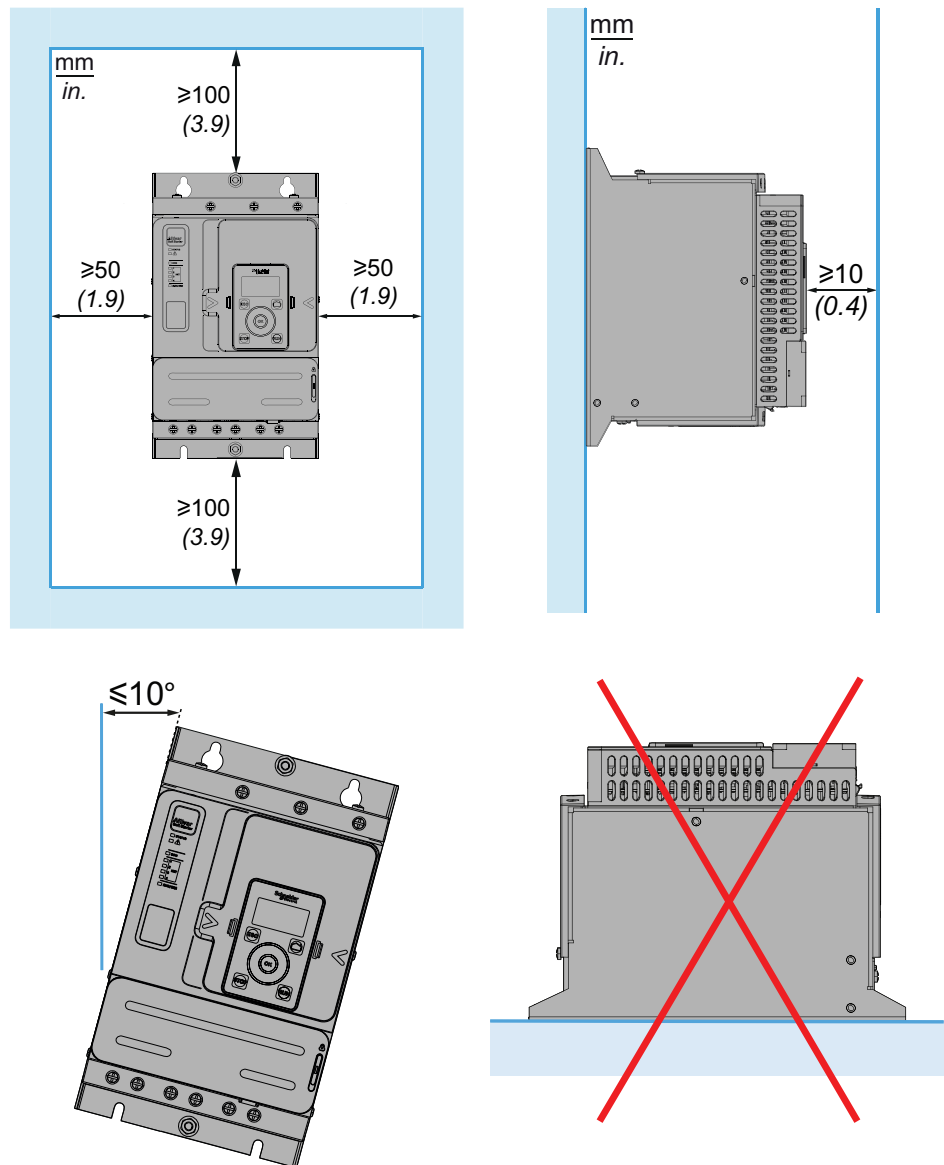

Soft Starter Cooling and Power Dissipation

Reference	Frame Size	Power Dissipated at Nominal Load in Normal Duty, not Bypassed (W)	Power Dissipated at Heavy Load in Normal Duty, not Bypassed (W)	Minimum air flow rate required	
				m ³ /hour	ft ³ /min
ATS480D17Y	A	38	26	No fan	
ATS480D22Y	A	54	39	No fan	
ATS480D32Y	A	84	54	14	8
ATS480D38Y	A	96	79	14	8
ATS480D47Y	A	122	96	28	16
ATS480D62Y	B	181	133	86	50
ATS480D75Y	B	225	181	86	50
ATS480D88Y	B	270	225	86	50
ATS480C11Y	B	302	232	86	50
ATS480C14Y	C	366	286	138	81
ATS480C17Y	C	459	371	138	81
ATS480C21Y	D	560	448	280	164
ATS480C25Y	D	675	560	280	164
ATS480C32Y	D	882	675	280	164
ATS480C41Y	E	1319	997	600	353
ATS480C48Y	E	1366	1152	600	353
ATS480C59Y	E	1711	1366	600	353
ATS480C66Y	E	1938	1711	600	353
ATS480C79Y	F	2517	2053	1200	706
ATS480M10Y	F	2845	2205	1200	706
ATS480M12Y	F	3472	2845	1200	706

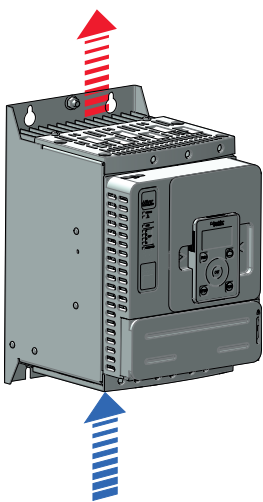

Fans switch to On as soon as the heatsink temperature reaches 50°C (122°F).
Fans switch to Off as soon as the heatsink temperature falls below 40°C (104°F).

When bypassed, the soft starter dissipates 25 W with fans Off and 110 W maximum.

Dimensions

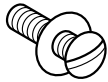

Use screws with DIN 125 washer to mount the soft starter. Tighten the fixing screws.

Altivar Soft Starter ATS480 CAD files can be downloaded from www.se.com.

ATS480D17Y...ATS480D47Y

Front, Side and Rear View

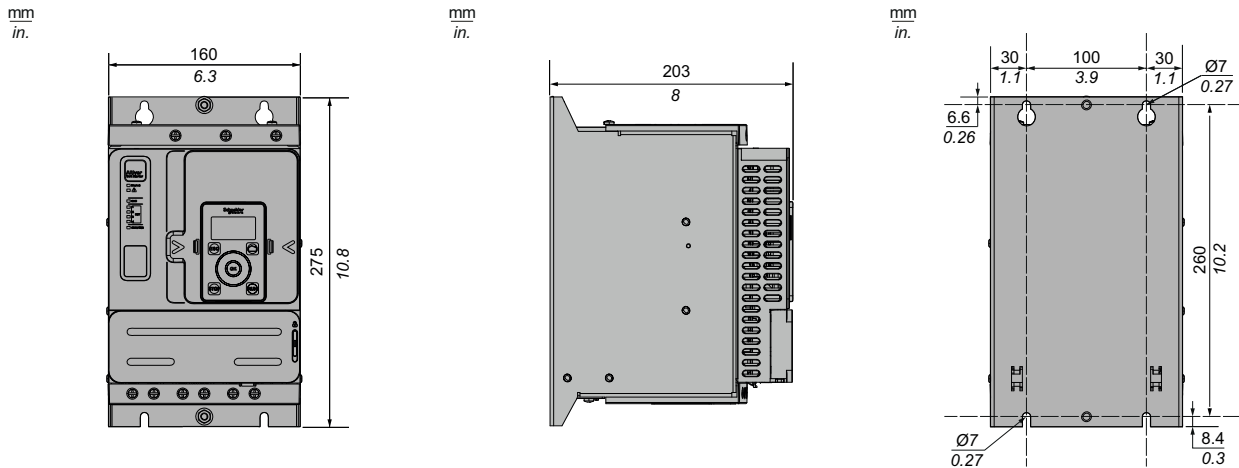

Mounting screws x 4: M6

ATS480D62Y...ATS480C11Y

Front, Side and Rear View

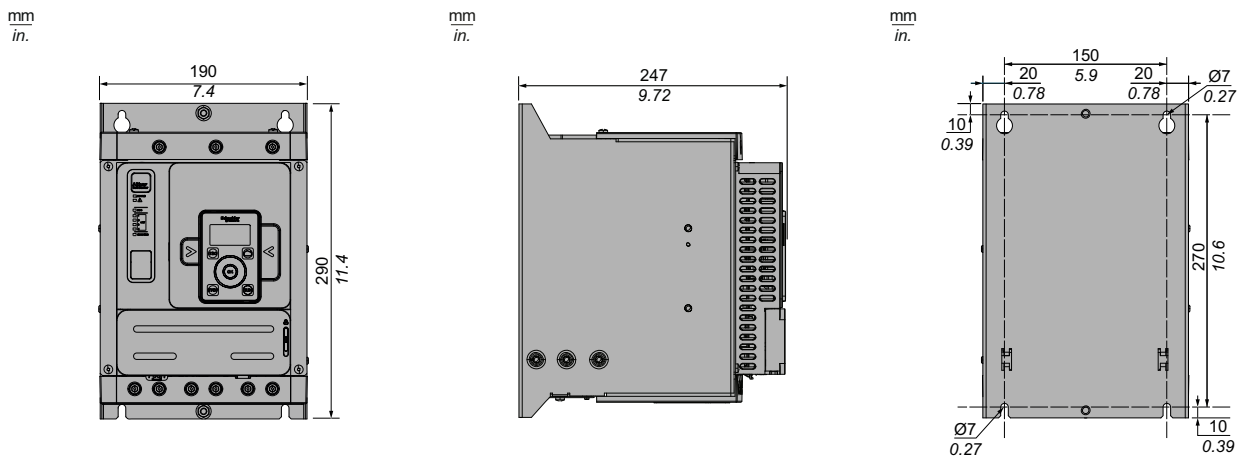

Mounting screws x 4: M6

ATS480C14Y...ATS480C17Y

Front, Side and Rear View

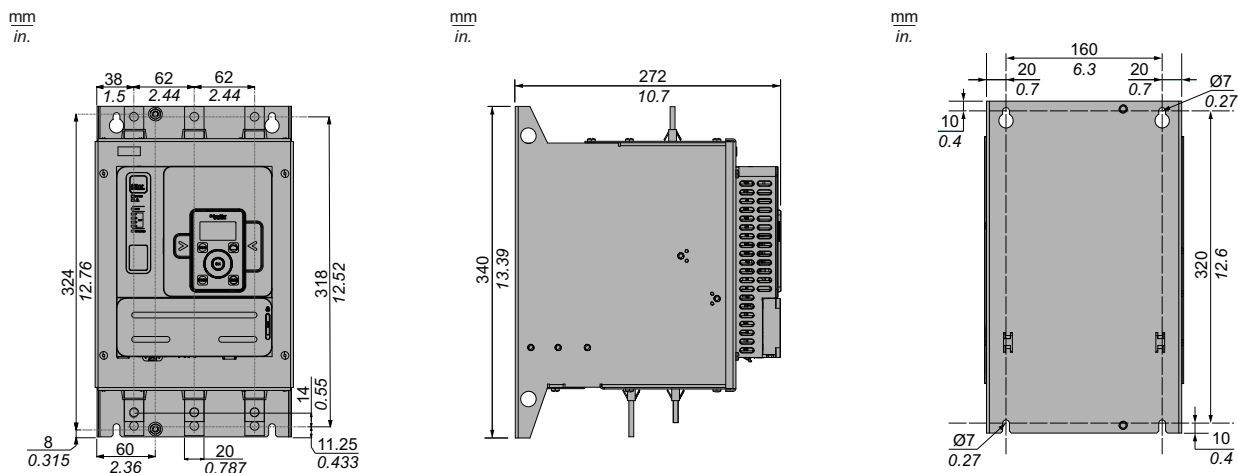

Mounting screws x 4: M6

ATS480C21Y...ATS480C32Y

Front, Side and Rear View

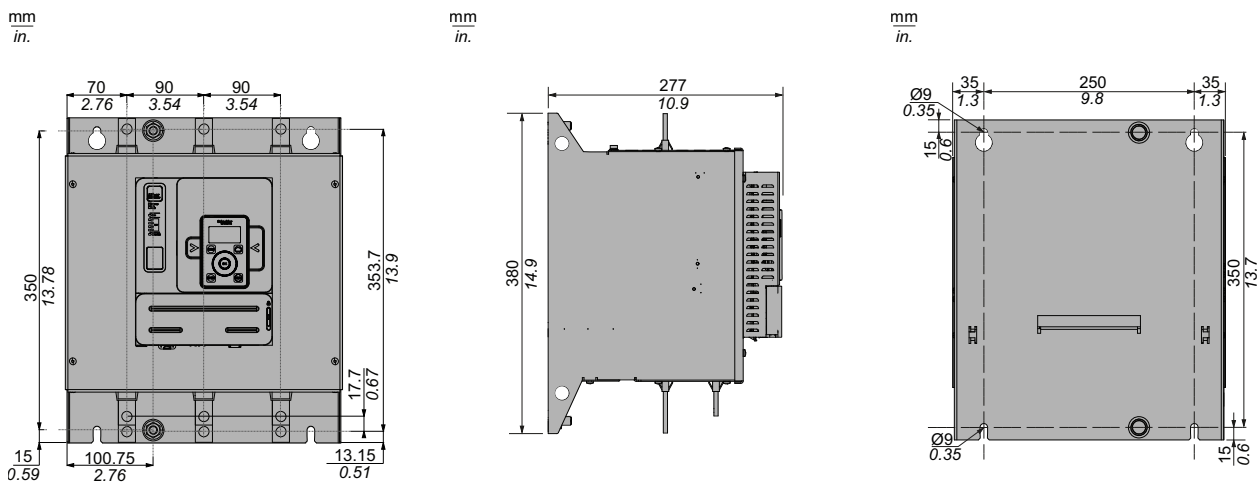

Mounting screws x 4: M8





Mounting display terminal on the door of the enclosure

The ATS480 is delivered with the VW3A1113 Plain Text Display Terminal.

The VW3A1111 Graphic Display Terminal is available as an option to replace the Plain Text Display Terminal.

Door mounting kits are available as options to mount the display terminal on the door of the enclosure.

Refer to the following table to choose a display terminal and its door mounting kit.

Door Mounting Kit protection degree	Display terminal	Door mounting kit
IP43	VW3A1113 Plain Text Display Terminal Delivered with the soft starter 	VW3A1114 door mounting kit. Available as option  Refer to the instruction sheet EAV91355.
IP65	VW3A1111 Graphic Display Terminal Available as option 	VW3A1112 door mounting kit. Available as option  Refer to the instruction sheet EAV76406.
Select one of the following RJ45 cables to connect the remote mounting kit to the soft starter: <ul style="list-style-type: none"> • 1 meter: VW3A1104R10 • 3 meters: VW3A1104R30 • 5 meters: VW3A1104R50 • 10 meters: VW3A1104R100 Not included with the remote kit		

Protective Covers For ATS480C41Y...M12Y

It is possible to limit direct access to the power terminals by installing protective covers for the following references:

- ATS480C41Y
- ATS480C48Y
- ATS480C59Y
- ATS480C66Y
- ATS480C79Y
- ATS480M10Y
- ATS480M12Y

Protective covers help to add a guarding to the IP00 power terminals to reduce accidental contact.

DANGER

HAZARD OF ELECTRIC SHOCK OR ARC FLASH

- Do not consider that the degree of protection is modified if the protective covers are added to the device.
- Before performing any work on and around the device, you must continue to follow the instructions given in this manual.

Failure to follow these instructions will result in death or serious injury.

NOTICE

DAMAGE TO THE DEVICE

- Follow the instructions given in this section to design and install the protective covers.
- Do not exceed the maximum limits specified.

Failure to follow these instructions can result in equipment damage.

To dimension the protective covers, it is required to respect the following limits:

- Protective cover material must be polymethyl methacrylate (PMMA)
- M6 fixing screws
- Maximum 5 mm (0,2 inch) thick
- Same width as the soft starter:
 - 400 mm (15,7 inches) for ATS480C41Y...ATS480C66Y
 - 770 mm (30;3 inches) for ATS480C79Y...ATS480M12Y
- Maximum length below and above the soft starter:
 - 220 mm (8,6 inches) for ATS480C41Y...ATS480C66Y
 - 250 mm (9,8 inches) for ATS480C79Y...ATS480M12Y

For a longer length, it is required to use support points on the cabinet.

The following measurements are in millimeters (inches).

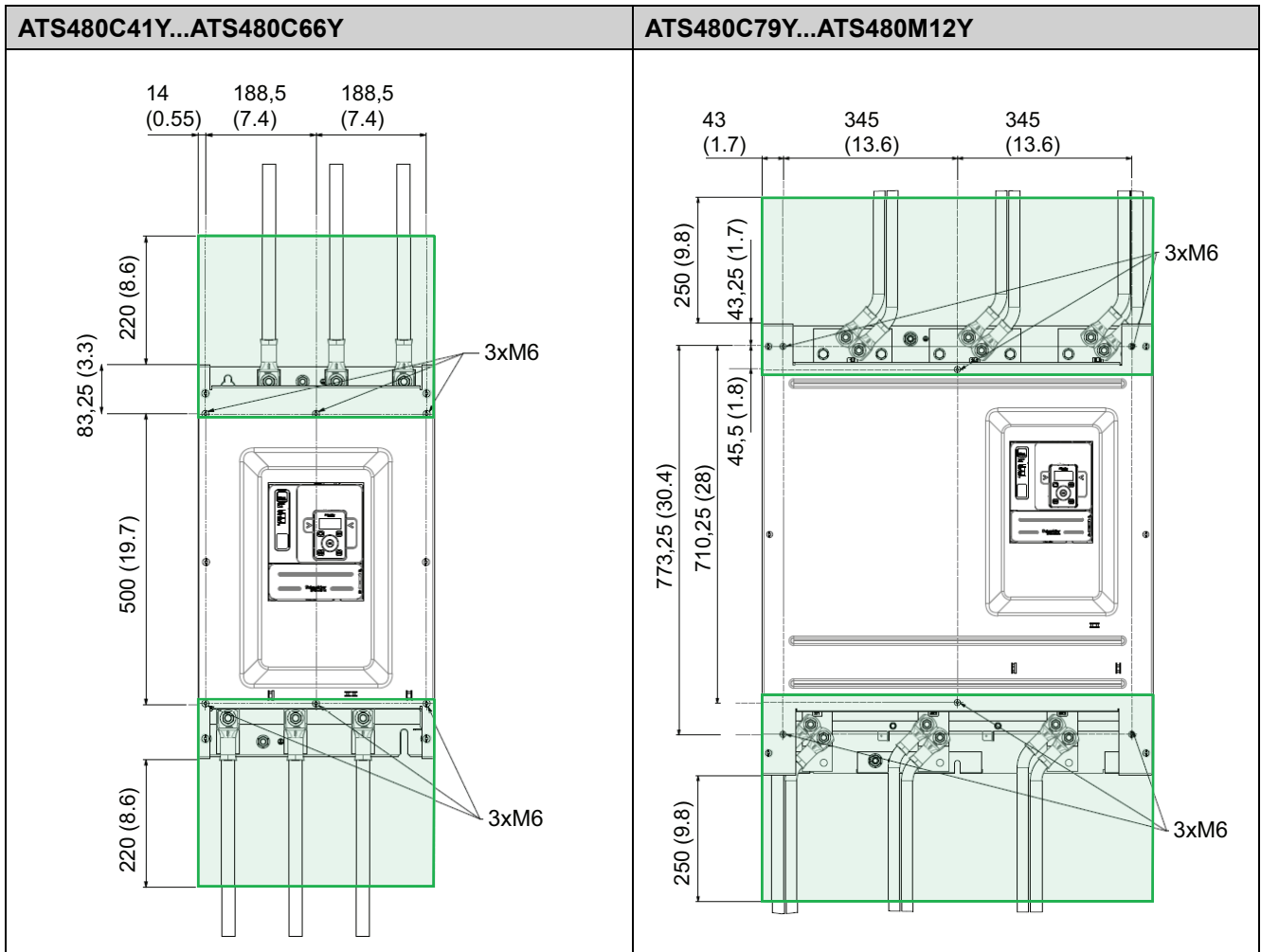

Fieldbus Modules

Fieldbus Modules can be used with the soft starter for communicating with the product, applying commands and monitoring.

For the list of Fieldbus Manuals refer to Related Documents, page 14.

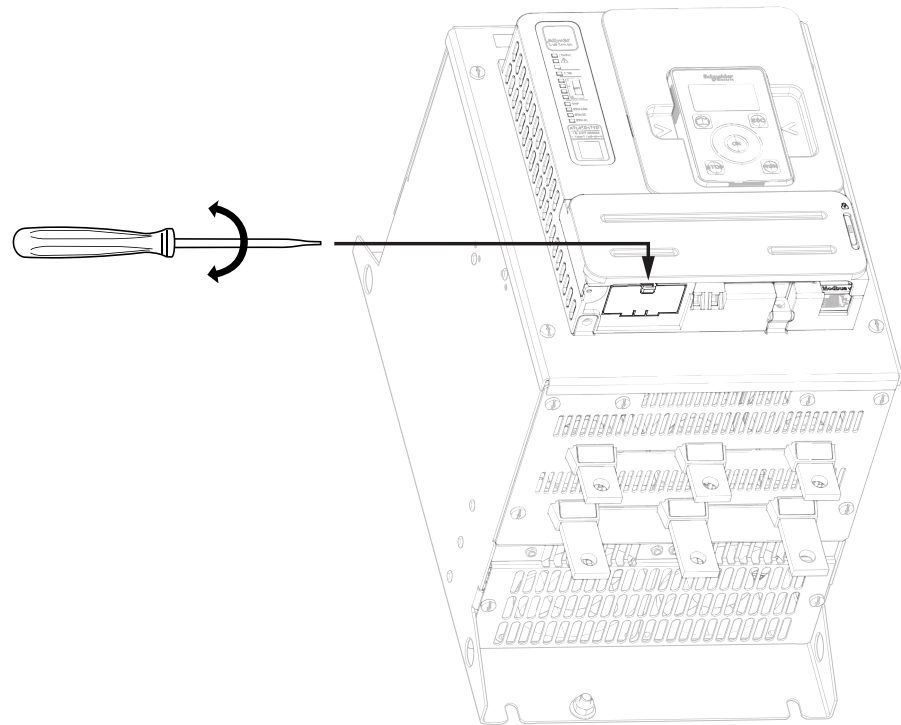

Wiring

What's in This Part

Power Terminals	43
Control Terminals	52
Application Diagrams.....	61
Types of coordination	69

General instructions

DANGER

HAZARD OF ELECTRIC SHOCK, EXPLOSION OR ARC FLASH

Read and understand the instructions in **Product Related Information** chapter before performing any procedure in this chapter.

Failure to follow these instructions will result in death or serious injury.

DANGER

HAZARD OF FIRE OR ELECTRIC SHOCK

- Wire cross sections and tightening torques must comply with the specifications provided in this document.
- If you use flexible multi-wire cables for a connection with a voltage higher than 25 Vac, you must use ring type cable lugs or wire ferrules, depending on the wire gauge and the specified stripping length of the cable.

Failure to follow these instructions will result in death or serious injury.

The product has a leakage current greater than 3.5 mA. If the protective ground connection is interrupted, a hazardous touch current may flow if the product is touched.

DANGER

ELECTRIC SHOCK CAUSED BY HIGH LEAKAGE CURRENT

Verify compliance with all local and national electrical code requirements as well as all other applicable regulations with respect to grounding of the entire installation.

Failure to follow these instructions will result in death or serious injury.

DANGER

INSUFFICIENT PROTECTION AGAINST SHORT CIRCUIT AND OVERCURRENTS CAN CAUSE FIRE OR EXPLOSION

- Use properly rated Short Circuit Protection Devices (SCPD).
- Use the fuses/circuit breakers specified.

Failure to follow these instructions will result in death or serious injury.

⚠️⚠️ DANGER

HAZARD OF ELECTRIC SHOCK, EXPLOSION, OR FIRE

The opening of the branch-circuit protective device is able to be an indication that a fault current has been interrupted.

- Current-carrying parts and other components of the controller should be examined and replaced if damaged.
- If burnout of the current element of an overload relay occurs, the complete overload relay must be replaced.

Failure to follow these instructions will result in death or serious injury.

Product may perform unexpected movements because of incorrect wiring, incorrect settings, incorrect data or other errors.

⚠️ WARNING

UNANTICIPATED EQUIPMENT OPERATION

- Carefully install the wiring in accordance with the EMC requirements.
- Do not operate the product with unknown or unsuitable settings or data.
- Perform a comprehensive commissioning test.

Failure to follow these instructions can result in death, serious injury, or equipment damage.

Refer to the following instructions to wire the soft starter:

- Do not route signal cables next to power cables.
- Cables connected to the motor must have the maximum possible separation from all other power cables. Do not run them in the same conduit. This separation reduces the possibility of coupling electrical noise between circuits.
- Voltage and frequency specifications for the supply mains must match the soft starter configuration.
- A disconnection switch must be installed between the supply mains and the soft starter.
- Power factor correction capacitors should not be connected to a motor controlled by a soft starter. If power factor correction is required, the capacitors must be located on the mains of the soft starter. A separate contactor should be used to switch the capacitors off when the motor is off, or during acceleration and deceleration. Use the relay R2 or a DQ (with an external device) assign to **[End Of Start]** to switch the contactors.
- The soft starter must be grounded to conform to the regulations concerning leakage currents. If the installation involves several soft starters on the same supply mains, each soft starter must be grounded separately.

Equipment Grounding

⚡⚠ DANGER

ELECTRIC SHOCK CAUSED BY INSUFFICIENT GROUNDING

- Verify compliance with all local and national electrical code requirements as well as all other applicable regulations with respect to grounding of the entire device.
- Ground the device before applying voltage.
- The cross section of the protective ground conductor must comply with the applicable standards.
- Do not use conduits as protective ground conductors; use a protective ground conductor inside the conduit.
- Do not consider cable shields to be protective ground conductors.

Failure to follow these instructions will result in death or serious injury.

Connection Instructions

The product has a leakage current greater than 3.5 mA. If the protective ground connection is interrupted, a hazardous touch current may flow if the product is touched.

⚡⚠ DANGER

ELECTRIC SHOCK CAUSED BY HIGH LEAKAGE CURRENT

Verify compliance with all local and national electrical code requirements as well as all other applicable regulations with respect to grounding of the entire installation.

Failure to follow these instructions will result in death or serious injury.

- Ensure that the resistance to Ground is 1 Ohm or less.
- When grounding several soft starters, you must connect each one directly, as shown in the above figure.
- Do not loop Ground cables or connect them in series.

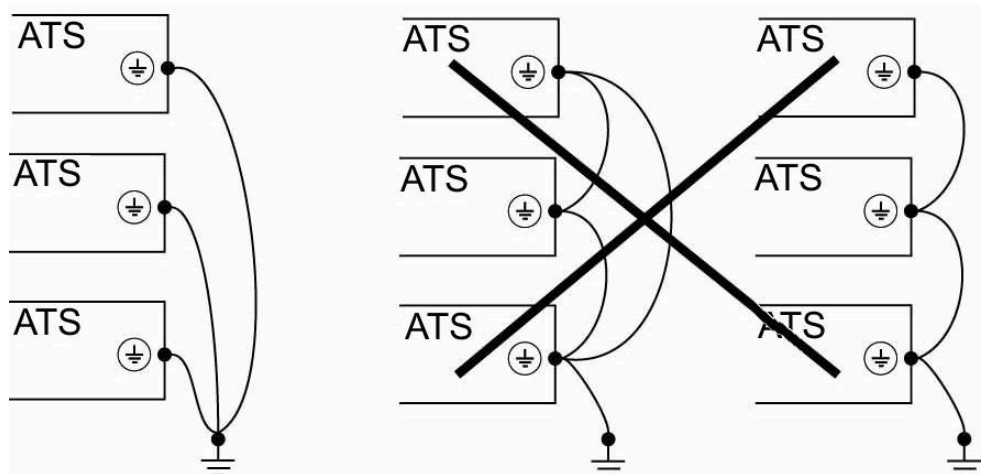

Power Terminals

What's in This Chapter

Wiring the Power Part for ATS480D17Y...ATS480C11Y	44
Wiring the Power Part for ATS480C14Y...ATS480M12Y	47
Connection Of The Motor and Supply Mains.....	50

Wiring the Power Part for ATS480D17Y...ATS480C11Y

Mains side

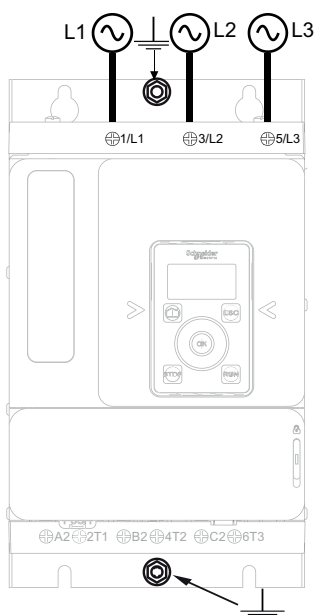

Motor side (bottom)

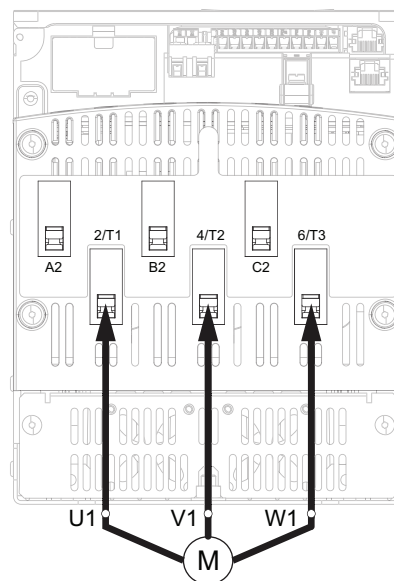

Use class C cables for the power connections.

- 1/L1, 3/L2, 5/L3: Mains supply inputs
- 2/T1, 4/T2, 6/T3: Outputs to motor
- A2, B2, C2: Soft starter bypass
- \perp : Ground connection

Simple diagrams for the power connections are available at Connection Of The Motor and Supply Mains, page 50.

Complete application diagrams including power and control connections are available at Application Diagrams, page 61.

Ground Connection Characteristics

References	Section	Tightening torque	Screw size
	mm ² (AWG)	N.m (lb.in)	
ATS480D17Y...D47Y	10 (8)	5 (44)	H10
ATS480D62Y...C11Y	16 (6)	5 (44)	

Recommended Wire cross section

Minimum wire cross section to be applied when the product is used at rated power:

References	Power connectors 1/L1, 3/L2, 5/L3, 2/T1, 4/T2, 6/T3, A2, B2, C2		
	Wire cross section (a) (b)		
	mm ² (AWG)		
	For current level at 0.4 of the soft starter rating	For current level at 1 of the soft starter rating	For current level at 1.3 of the soft starter rating
ATS480D17Y	2.5 (12)	2.5 (12)	4 (10)
ATS480D22Y	2.5 (12)	4 (10)	6 (10)
ATS480D32Y	2.5 (12)	6 (10)	10 (8)
ATS480D38Y	2.5 (12)	10 (8)	10 (8)
ATS480D47Y	2.5 (12)	10 (8)	10 (8)
ATS480D62Y	4 (10)	16 (6)	25 (4)
ATS480D75Y	6 (10)	25 (4)	35 (3)
ATS480D88Y	10 (8)	35 (3)	35 (2)
ATS480C11Y	10 (8)	35 (2)	35 (1/0)

- **(a)** The cable gauge affects the IP protection degree. IP20 protection degree requires a minimum cable gauge of 16 mm² (4 AWG) and end caps. If this condition is not met, the IP protection degree is IP10.
- **(b)** The cross section cable values are given for one cable per cages. The good behavior of the ATS480 is not assured with more than one cable per cages.

Mechanical capacity of terminal blocks, stripping length, tightening torque

References	Power connectors 1/L1, 3/L2, 5/L3, 2/T1, 4/T2, 6/T3, A2, B2, C2			
	Mechanical wire cross section (a) (b) mm ² (AWG)		Stripping length	Tightening torque
	Minimum	Maximum	mm (in)	N.m (lb.in)
ATS480D17Y	2.5 (12)	16 (4)	9 (0.35) ±1 (0.04)	3 (26)
ATS480D22Y				
ATS480D32Y				
ATS480D38Y				
ATS480D47Y				
ATS480D62Y	4 (10)	50 (1/0)	20 (0.79) ±1 (0.04)	10 (89)
ATS480D75Y				
ATS480D88Y				
ATS480C11Y				
<ul style="list-style-type: none"> • (a) The cable gauge affects the IP protection degree. IP20 protection degree requires a minimum cable gauge of 16 mm² (4 AWG) and end caps. If this condition is not met, the IP protection degree is IP10. • (b) The cross section cable values are given for one cable per cages. The good behavior of the ATS480 is not assured with more than one cable per cages. 				

Wiring the Power Part for ATS480C14Y...ATS480M12Y

Mains side

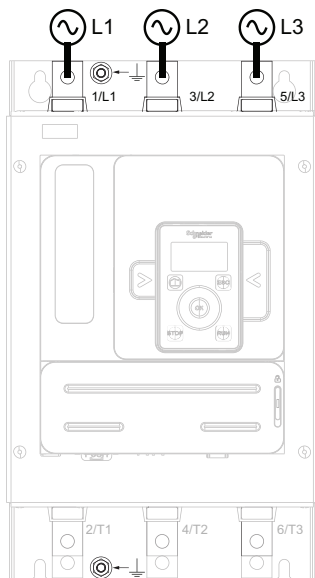

Motor side (bottom)

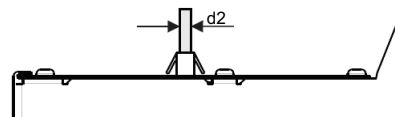
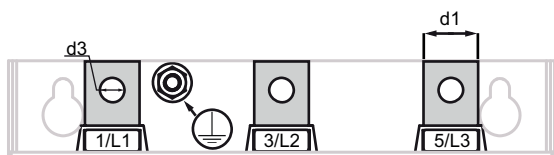
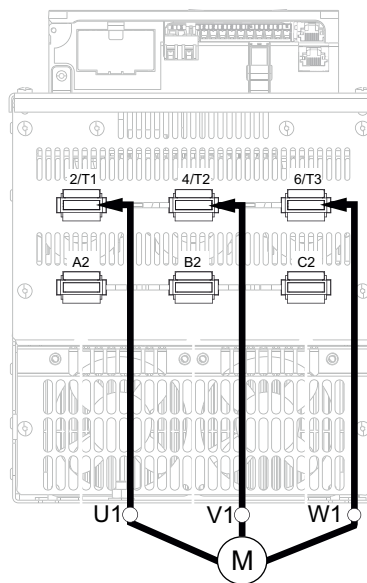

NOTE: Do not access the power bars when the supply mains is On.

NOTE: Do not access the power bars when the supply mains is On.

- 1/L1, 3/L2, 5/L3: Mains supply inputs
- 2/T1, 4/T2, 6/T3: Outputs to motor
- A2, B2, C2: Soft starter bypass
- ⊥ : Ground connection

Simple diagrams for the power connections are available at Connection Of The Motor and Supply Mains, page 50.

Complete application diagrams including power and control connections are available at Application Diagrams, page 61.

Ground Connection Characteristics

References	Section	Tightening torque	Screw size
	mm ² (AWG)	N·m (lb.in)	
ATS480C14Y...C17Y	35 (4)	5 (44)	H10
ATS480C21Y...C32Y	95 (3)	24 (212)	H16
ATS480C41Y...C66Y	240 (2/0)	24 (212)	H16
ATS480C79Y...M12Y	300 (4/0)	24 (212)	H16

Recommended Wire cross section

Minimum wire cross section to be applied when the product is used at rated power:

References	Power connectors 1/L1, 3/L2, 5/L3, 2/T1, 4/T2, 6/T3, A2, B2, C2		
	Section mm ² (AWG)		
	For current level at 0.4 of the soft starter rating	For current level at 1 of the soft starter rating	For current level at 1.3 of the soft starter rating
ATS480C14Y	16 (6)	50 (1/0)	95 (3/0)
ATS480C17Y	25 (4)	70 (2/0)	95 (4/0)
ATS480C21Y	25 (4)	95 (4/0)	150 (300 kcmil)
ATS480C25Y	35 (3)	120 (250 kcmil)	185 (400 kcmil)
ATS480C32Y	50 (1)	185 (400 kcmil)	2x150 (2x250 kcmil)
ATS480C41Y	70 (2/0)	2x150 (2x250 kcmil)	2x185 (2x350 kcmil)
ATS480C48Y	95 (AWG3/0)	2x150 (2x250 kcmil)	2x185 (2x350 kcmil)
ATS480C59Y	120 (250 kcmil)	2x185 (2x350 kcmil)	2x240 (3x300 kcmil)
ATS480C66Y	150 (300 kcmil)	2x240 (3x300 kcmil)	Cu bar 2x(60x5mm) (2x0.25")
ATS480C79Y	185 (400 kcmil)	2x240 (3x300 kcmil)	Cu bar 2x(80x5mm) (2.5x0.25")
ATS480M10Y	2x150 (2x250 kcmil)	Cu bar 2x(60x5mm) (2x0.25")	Cu bar 2x(100x5mm) (3x0.25")
ATS480M12Y	2x150 (2x250kcmil)	Cu bar 2x(80x5mm) (2.5x0.25")	Cu bar 2x(100x5mm) (3x0.25")

Bar specification, stripping length, tightening torque

References	Power connectors 1/L1, 3/L2, 5/L3, 2/T1, 4/T2, 6/T3, A2, B2, C2			
	Bar specification			Tightening torque
	d1 mm (in)	d2 mm (in)	d3 mm (in)	N.m (lb.in)
ATS480C14Y	20 (0.8)	5 (0.2)	9 (0.3)	34 (300)
ATS480C17Y				
ATS480C21Y	20 (0.8)	5 (0.2)	12 (0.5)	34 (300)
ATS480C25Y				
ATS480C32Y				
ATS480C41Y	40 (1.5)	5 (0.2)	14 (0.5)	57 (500)
ATS480C48Y				
ATS480C59Y				
ATS480C66Y				
ATS480C79Y	60 (2.3)	5 (0.2)	14 (0.5)	57 (500)
ATS480M10Y				
ATS480M12Y				

Special case of Aluminum cables:

The use of aluminum field wiring cables is allowed on ATS480 from ATS480C14Y to ATS480M12Y with limitation.

In case of usage of terminal protection kits, the cross section of aluminum cable may be incompatible with the protection kit capacity and can cause equipment damage or impossible mounting.

⚠ DANGER

HAZARD OF FIRE OR/AND TERMINALS OVERHEATING

- The plating of aluminum wire termination must only be compatible with the tin plated copper terminals of the product as regards to galvanic corrosion.
- The sizing of the aluminum wires must be made in accordance with the information below⁽¹⁾.
- The sizing of aluminum wire terminations must not exceed the terminal dimension capacity (refer to [Power Connections table](#)).
- Cross sections exceeding the terminal dimension capacity can cause impossible wiring, damage on the terminals or the equipment, or electrical insulation weakness and therefore shall be avoided.
- The tightening torque on aluminum wires termination must be adapted to prevent damage during installation, reduce creeping risk and prevent risk of overheating in operation⁽²⁾.
- In order to prevent risks from aluminum oxide low conductivity, the aluminum wire termination must be protected against corrosion or not submitted to corrosive substances.

Failure to follow these instructions will result in death or serious injury.

(1) : Sizing of the aluminum wires minimum cross section based on:

- NFPA70 Table 310.16 considering ambient temperature, insulation type and cable arrangement.
- Or IEC60364–5 considering ambient temperature, insulation type and cable arrangement.
- Or the application sizing standard for aluminum wire in the country of use.

(1) : Sizing of the aluminum wires maximum cross section mechanically allowable by the terminal (refer to the User Manual for terminal size information) and is made under the responsibility of the user.

(2) : Tightening torque on Aluminum terminals :

- Must be compatible with the acceptable range of the terminal if existing (refer to [Power Connections table](#)).
- Must be adapted to the current rating and the surface in contact.
- Is chosen under the responsibility of the user.

Connection Of The Motor and Supply Mains

Connection In-Line

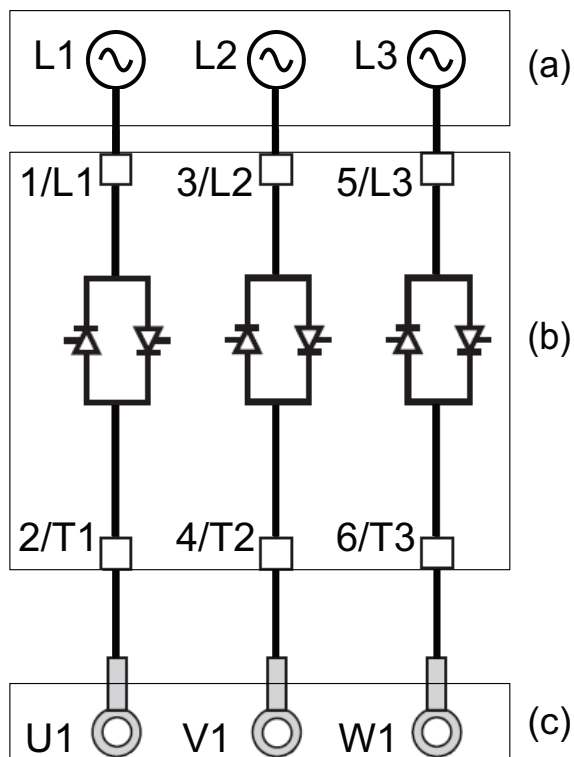

The soft starter can be connected in-line to the motor supply. The motor connection type (star/delta) depends on the supply mains, refer to the motor nameplate.

- (a): Supply mains
- (b): Soft starter
- (c): Induction motor

Bypassing The Soft Starter

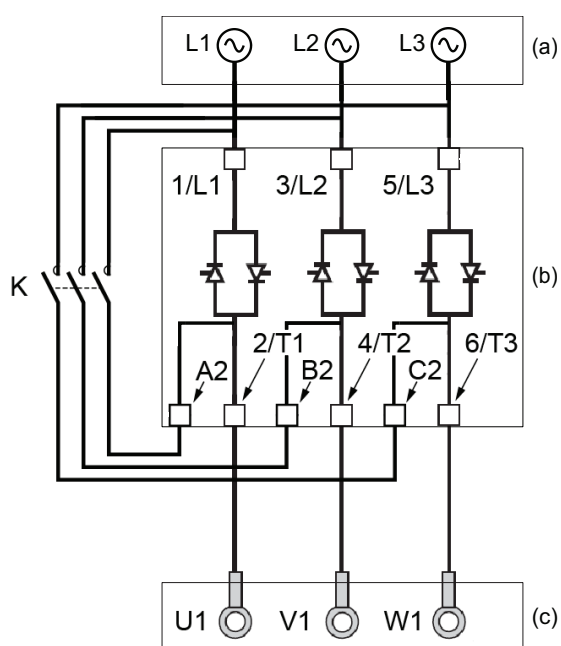

The soft starter can be bypassed with a contactor (K) at end of start. The bypass contactor can be controlled by the soft starter, using the relay R2. The monitoring functions such as current measurement remain active when the soft starter is bypassed.

Bypassing soft starter limits heat dissipation of the SCR, which allows:

- To downsize the soft starter by one current rating
- More starts per hour
- Higher starting current
- Longer starting time
- (a): Supply mains
- (b): Soft starter
- (c): Induction motor
- K: External bypass connector

Connection In The Motor Delta Winding

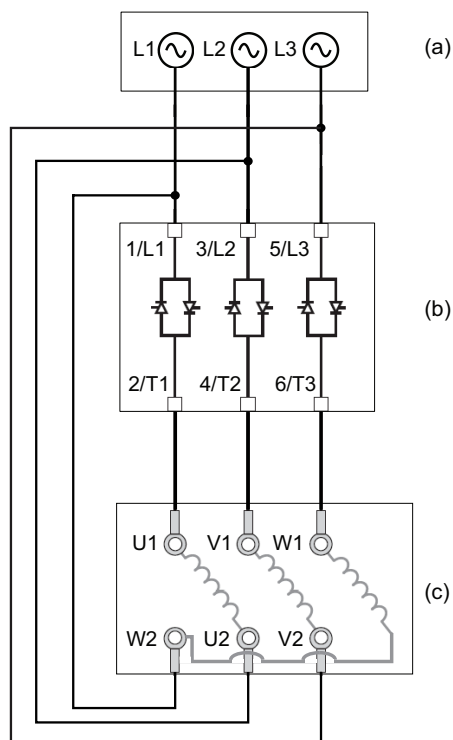

The Soft starter can be connected in series with motor windings in a delta connection (inside the delta connection). By doing so, for the same motor power rating, the current going through the winding and the soft starter is reduced by $1.7 (\sqrt{3})$. This reduction allows to choose a soft starter with lower current rating.

Example:

Using a 400V 110kW 4 pole motor with a mains supply current of 195A (nominal current for the delta connection).

- In-line connection: a soft starter is selected with a current rating just above 195A, i.e. ATS480C21Y (210A) for a normal duty application.
- Inside delta connection: the current in each winding is equal to $195/\sqrt{3} = 114\text{A}$, ATS480C14Y is sufficient for this normal duty application.
- (a): Supply mains
- (b): Soft starter
- (c): Induction motor

For more information about the parameters enabling inside-delta usage, refer to [Connection Inside The Delta Of The Motor](#), page 119.

Control Terminals

What's in This Chapter

Control Terminals Layout	53
Control Block Wiring Diagram.....	54
Control Terminal Characteristics	54
RUN and STOP Management	56
Relay Contacts Wiring	58

DANGER

HAZARD OF FIRE OR ELECTRIC SHOCK

- Wire cross sections and tightening torques must comply with the specifications provided in this document.
- If you use flexible multi-wire cables for a connection with a voltage higher than 25 Vac, you must use ring type cable lugs or wire ferrules, depending on the wire gauge and the specified stripping length of the cable.

Failure to follow these instructions will result in death or serious injury.

When the soft starter transitions to operating state Fault, the mains contactor must be deenergized.

WARNING

UNANTICIPATED EQUIPMENT OPERATION

- Connect the coil of the mains contactor to output relay R1.

Failure to follow these instructions can result in death, serious injury, or equipment damage.

Control Terminals Layout

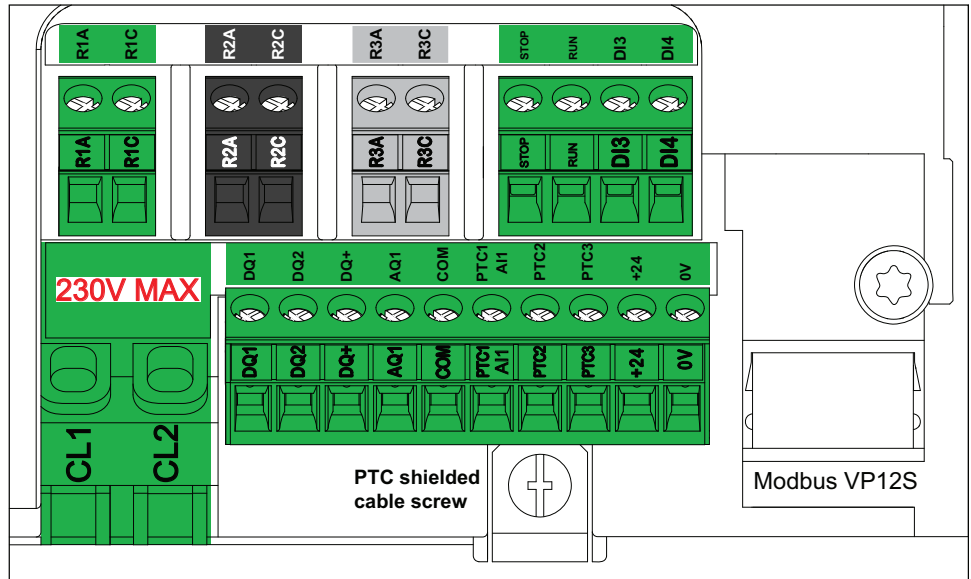

The control terminals are installed with one-way plug-in connectors. Ferrules are mandatory for wiring the CL1 and CL2 terminals to ensure an IP20 protection. The terminals are approved for stranded conductors and solid conductors. Use wire cable ends (ferrules) if possible.

NOTE:

- Do not access the terminals CL1 and CL2 when the soft starter is supplied.
- Modbus VP12S: This is the standard Modbus serial link marking. VP●S means connector with power supply, where 12 stands for the 12 Vdc supply voltage.

NOTICE

INCORRECT VOLTAGE

- Supply the control supply terminals CL1 / CL2 within a range of 110...230 Vac only
- In case of migration from ATS48●●●Q to ATS480●●●Y, adapt the control supply transformer

Failure to follow these instructions can result in equipment damage.

Tightening torque max N.m (lbf.in)	Min relay output wire cross section mm ² (AWG)	Other min wire cross section mm ² (AWG)	Max connection capacity mm ² (AWG)	Stripping length mm (in)	
				Min	Max
0.5 (4.4)	0.75 (18)	0.5 (20)	2.5 (13)	5.5 (0.2)	7.5 (0.3)

Those values are given for a single wire per terminal. Use a shunt to create a bridge between terminals if necessary.

Control Block Wiring Diagram

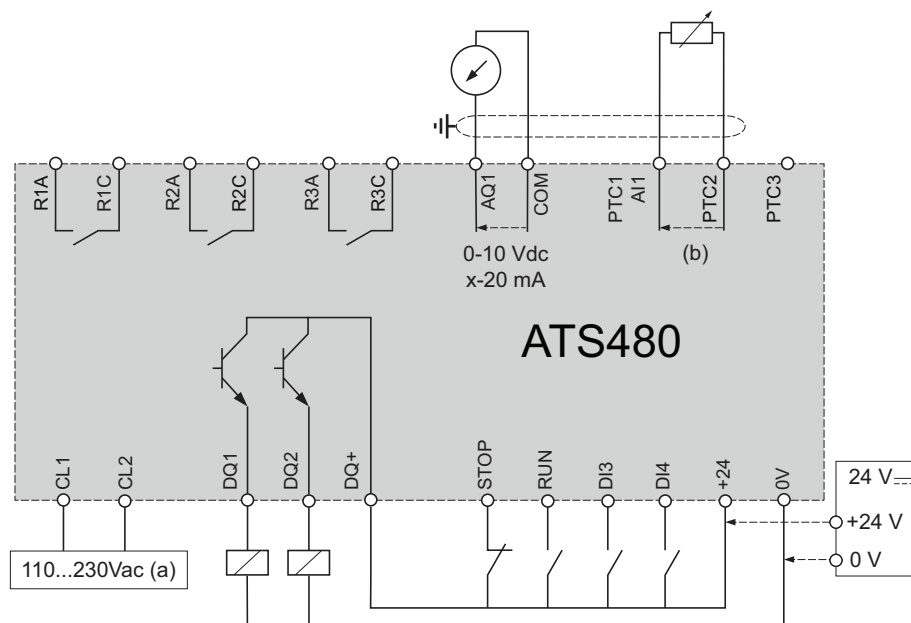

- (a): Control supply 110...230 Vac
- (b): 2 wire PTC/PT100

PT100 Thermal Probe 3 Wires:

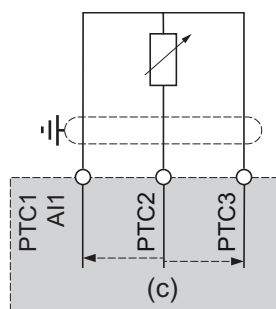

(c): 3 wire PT100

Control Terminal Characteristics

The ATS480 can start and stop the motor in “2-wire control” or “3-wire control”, depending on how the STOP and RUN terminals are wired. Simple diagrams explaining those two modes and how to wire the terminals STOP and RUN are available at RUN and STOP Management, page 56.

Complete application diagrams including power and control connections are available at Application Diagrams, page 61.

To control the motor, the ATS480 must be supplied in 110...230 Vac via the terminals CL1 and CL2.

To maintain communication with the soft starter when CL1 and CL2 are absent, the ATS480 control part can be supplied in 24 Vdc via the terminal +24.

Reference	Control block apparent power (VA) supply
ATS480D17Y...D22Y	60
ATS480D32Y...C17Y	90
ATS480C21Y...C41Y	106
ATS480C48Y...C66Y	125
ATS480C79Y...M12Y	200

Terminals	Function	I/O	Characteristics
CL1	Control power supply	I	<ul style="list-style-type: none"> 110...230 Vac +10% – 15%, 50/60 Hz
CL2			
R1A	Programmable NO relay R1 – Assigned to Operating state Fault by default	O	<ul style="list-style-type: none"> Max voltage: 250 Vac. Min. switching capacity: 10 mA for 24 Vdc Max. switching capacity on inductive load following IEC60947-2: <ul style="list-style-type: none"> 2A/250Vac for AC15 100 000 cycles 2A/30Vdc for DC13 150 000 cycles
R1C			
R2A	NO relay R2 – Assigned to End of starting. Will close when the soft starter is in established regime.	O	
R2C			
R3A	Programmable NO relay R3	O	<p>Inductive load must be equipped with a voltage surge suppression device according to ac or dc operation with total energy dissipation greater than the inductive energy stored in the load.</p> <p>Refer to sections Output Relay with Inductive AC Loads, page 58 and Output Relay with Inductive DC Loads, page 59.</p>
R3C			
STOP	Digital Input 1 — Assigned to STOP	I	<ul style="list-style-type: none"> 4 x 24 Vdc digital inputs with 4.3 kΩ impedance U_{max} = 30 V I_{max} = 8 mA State 1: U > 11 V and I > 5 mA State 0: U < 5 V and I < 2 mA Response time: 2 ms ± 0.5 ms max
RUN	Digital Input 2 — Assigned to RUN	I	
DI3	Digital Input 3	I	
DI4	Digital Input 4	I	
0V	Common for +24	I/O	<ul style="list-style-type: none"> 0 V
+24	Supply for digital output	I/O	<ul style="list-style-type: none"> U_{min}: 19 Vdc U_{nominal}: 24 Vdc U_{max}: 30 Vdc I_{max}: 200 mA Isolated and protected against short-circuits and overloads, maximum current 200 mA. Can be used to supply the control block with an external 24Vdc supply if CL1 and CL2 are absent to keep communication with the product <p>NOTE: The +24 terminal does not entirely substitute supply from CL1 and CL2. The motor cannot be controlled if you supply the ATS480 via only the +24 terminal. To control the motor, the ATS480 must be supplied via CL1 and CL2.</p>
DQ+	Digital output supply	O	<ul style="list-style-type: none"> 24 Vdc digital output supply
DQ1	Programmable digital output 1	O	<ul style="list-style-type: none"> 2 open collector outputs compatible with level 1 PLC, IEC 65A-68 standard. Power supply +24 Vdc (min. 12 Vdc, max 30 Vdc) Max. current 100 mA per output with an external source Max frequency: 1kHz
DQ2	Programmable digital output 2	O	

Terminals	Function	I/O	Characteristics
AQ1	Programmable analog Output 1	O	<ul style="list-style-type: none"> Available signal: 0 – 10 Vdc 0 – 20 mA, can be configured as 4 – 20 mA Accuracy $\pm 1\%$ for temperature range -10 to $+60^{\circ}\text{C}$ Resolution: 10 bits Linearity: $\pm 0.2\%$ Sampling time: 5 ms + 1 ms maximum Applicable load: 470 Ω min, 470 Ω max
COM	I/O common	I/O	<ul style="list-style-type: none"> 0 V
PTC1 / AI1	Motor thermal sensor connection	I	<ul style="list-style-type: none"> Configurable for PTC and PT100 (2/3 wires) Total resistance of sensor circuit 750 Ω at 25°C Overheat trigger threshold: 2.9 kΩ \pm 0.2 kΩ Overheat reset threshold: 1.575 kΩ \pm 0.75 kΩ Threshold for low impedance detection: 50 kΩ –10 Ω / +20 Ω Protected for low impedance < 1000 Ω Refer to 2.11 [Thermal monitoring] TPP, page 153 for more information on thermal sensors.
PTC2			
PTC3			

RUN and STOP Management

2–wire control

Run and Stop are controlled by state 1 (closed, active) or 0 (open, inactive), on the Run and Stop terminals.

At power-up or on manual error reset, the motor will start if RUN is active.

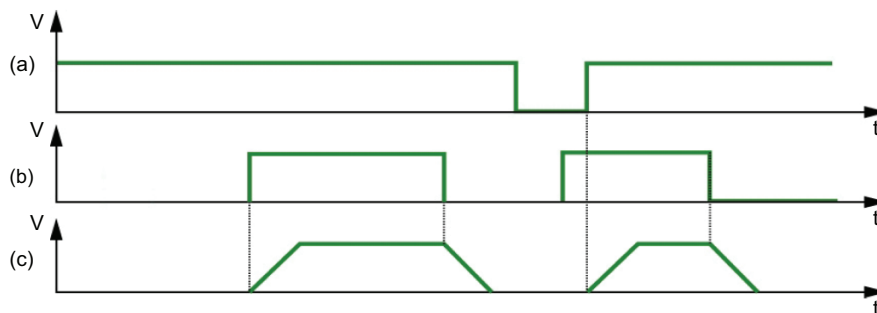
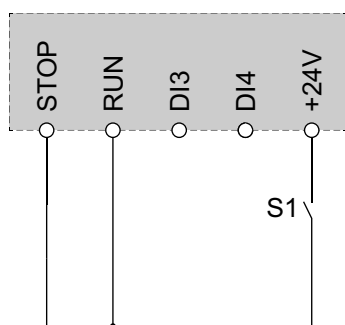

- V: Voltage
- t: Time
- (a): Control supply (CL1 / CL2 terminals)
- (b): Run order (Stop / Run terminals)
- (c): Motor rotation

3-wire control

Run and Stop are controlled by 2 different digital inputs. The Stop order is applied at low level on the Stop terminal. The Run order is applied at high level on the Run terminal only if Stop terminal is at high level.

On Power-up or manual Error Reset or after a Stop command coming from the active channel command, the motor will be powered if a Run command is active. If a Stop command is applied via a different channel command, the motor can only be powered again by removing the active Run command and applying a new one.

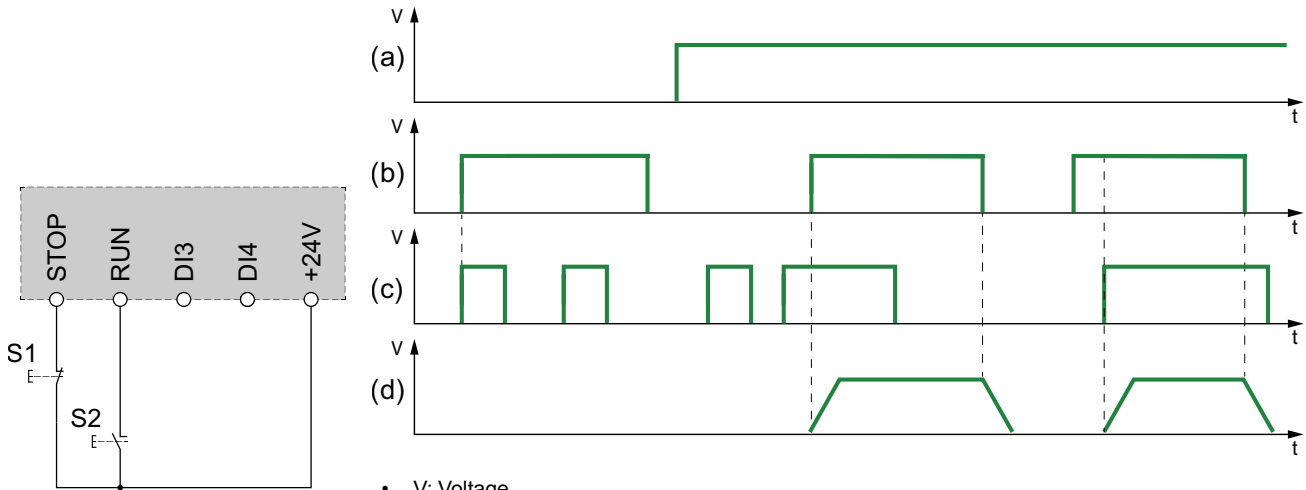

- V: Voltage
- t: Time
- (a): Control supply (CL1 / CL2 terminals)
- (b): Stop terminal logic level
- (c): Run terminal logic level
- (d): Motor rotation

Fieldbus and Display Terminal connection

When Fieldbus or Display Terminal is used to control the soft starter, the STOP must be connected to the +24V.

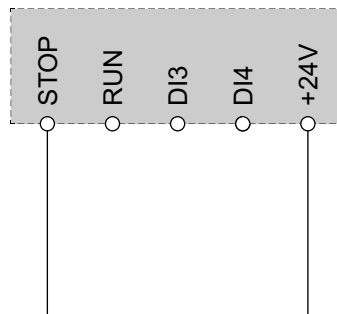

Behavior of the soft starter when [Fault Reset Assign] R_{SF} is not assigned

When [Fault Reset Assign] R_{SF} is not assigned, in terminal control apply a Run order can reset the error of the soft starter. A second run order is necessary to restart the motor. For more information about Fault reset function refer to 3.9 [Error/Warn handling] CSWM, page 178.

Relay Contacts Wiring

General

The AC voltage source must be of overvoltage category II (OVC II) according to IEC 60947-4-2 and IEC 60947-1.

If it is not the case, an isolation transformer must be used.

Contactors with AC Coil

If controlled by a relay, a resistor-capacitor (RC) circuit must be connected in parallel to the coil of the contactor as shown on the drawing below.

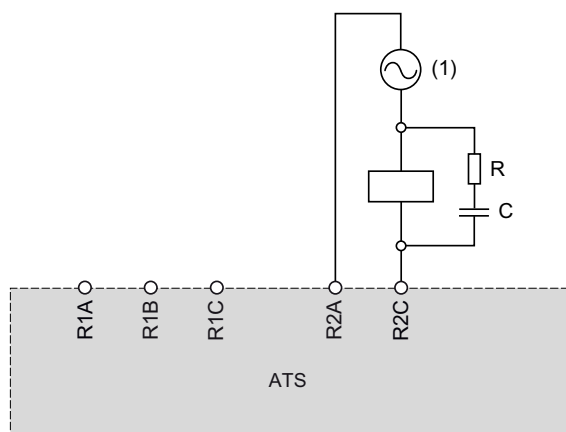

(1) AC 250 Vac maximum.

Schneider Electric AC contactors have a dedicated area on the housing to plug easily the RC device. Refer to the Motor control and protection components catalog MKTED210011EN available on se.com to find the RC device to be associated with the contactor used.

Example: With a 48 Vac source, contactors LC1D09E7 or LC1DT20E7 have to be used with LAD4RCE voltage suppression device.

Other Inductive AC Loads

For other inductive AC loads:

- Use an auxiliary contactor connected on the product to control the load.
Example: with a 48 Vac source, auxiliary contactors CAD32E7 or CAD50E7 with LAD4RCE voltage suppression device.
- When using a third-party inductive AC load, request the supplier to provide information on the voltage suppression device, in order to avoid overvoltage above 375 V during relay opening.

Contactors with DC Coil

If controlled by a relay, a bidirectional transient voltage suppression (TVS) diode, also called transil, must be connected in parallel to the coil of the contactor as shown on the drawing below.

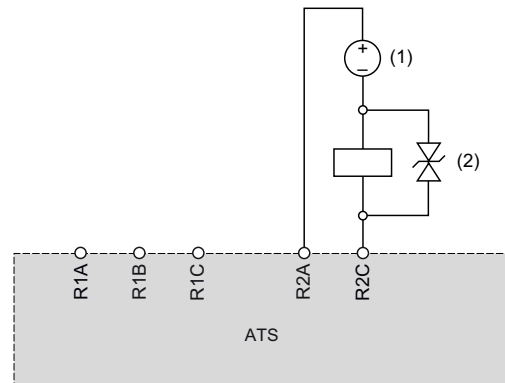

(1) DC 30 Vdc maximum.

(2) TVS diode

Schneider Electric contactors with DC coil include the TVS diode. No additional device is required.

Refer to the Motor control and protection components catalog MKTED210011EN available on se.com for more information.

Other Inductive DC Loads

Other inductive DC loads without embedded TVS diode must use one of the following voltage suppression device:

- A bidirectional TVS device as shown on the drawing above, defined by:
 - TVS break-down voltage greater than 35 Vdc,
 - TVS clamping voltage V(TVS) less than 50 Vdc
 - TVS peak power dissipation greater than load rated current, I(load) x V(TVS).

Example: with I(load) = 0.9 A and V(TVS) = 50 Vdc, TVS peak power must be greater than 45 W

- TVS average power dissipation greater than the value calculated by the following $0.5 \times I(\text{load}) \times V(\text{TVS}) \times \text{load time constant} \times \text{number of operation per second}$.

Example: with I(load) = 0.9 A and V(TVS) = 50 Vdc, load time constant = 40 ms (load inductance divided by load resistance) and 1 operation every 3 s, the TVS average power dissipation must be greater than $0.5 \times 0.9 \times 50 \times 0.04 \times 0.33 = 0.3 \text{ W}$.

- A fly-back diode as shown in the drawing below.

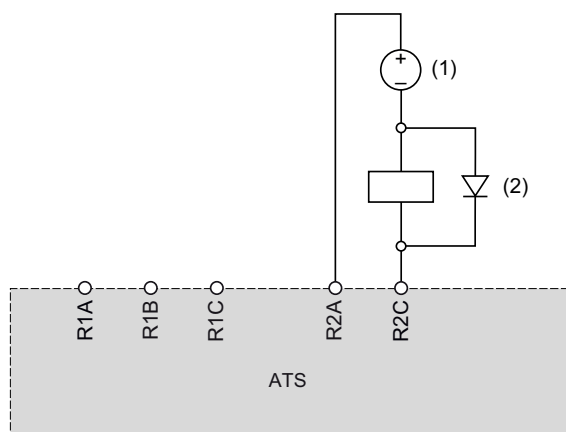

(1) DC 30 Vdc maxi.

(2) Flyback diode

The diode is a polarized device. The fly-back diode must be defined by:

- A reverse voltage greater than 100 Vdc,
- A rated current greater than two times the load rated current,
- A thermal resistance: junction to ambient temperature (in K/W) less than $90 / (1.1 \times I(\text{load}))$ to operate at maximum 60°C (140°F) ambient temperature.

Example: with I(load) = 1.5 A, select a 100 V, 3 A rated current diode with a thermal resistance from junction to ambient less than $90 / (1.1 \times 1.5) = 54.5 \text{ K/W}$.

Using a flyback diode, the relay opening time will be longer than with a TVS diode.

NOTE: Use diodes with leads for easy wiring and keep at least 1 cm (0.39 in.) of leads on each side of the case of the diode for a correct cooling.

Application Diagrams

Seven applications diagrams are provided in this manual:

1. Connection In Line, With Line Contactor, No Bypass, Type 1 or 2 Coordination, 2-wire or 3-wire control, see , page 62.
2. Connection In Line, With Line Contactor, No Bypass, Type 1 or 2 Coordination, 2-wire control, see , page 63.
3. Connection In Line, With Line and Bypass Contactor, Freewheel Or Controlled Stop, Type 1 or 2 Coordination, 2-wire or 3-wire, see , page 64.
4. Connection In Line, With Line and Bypass Contactor, Freewheel Or Controlled Stop, Type 1 or 2 Coordination, 2-wire or 3-wire, see , page 65.
5. Connection Inside the Delta, With Line and Bypass Contactor, Type 1 and 2 Coordination, 2-wire or 3-wire, see , page 66.
6. Connection Inside the Delta, With Line and Bypass Contactor, Type 1 or 2 Coordination, 2-wire or 3-wire, see , page 67.
7. Connection to a Two Speeds Motor With Two Sets of Parameters, Line and Bypass Contactor, Type 1 or 2 Coordination, 2-wire Control, see , page 68.
8. Non-reversing With Line Contactor, Starting And Deceleration Of Several Cascaded Motors With A Single Soft Starter, refer to the application note NNZ85564 (English).

1. Connection In Line, With Line Contactor, No Bypass, Type 1 or 2 Coordination, 2-wire or 3-wire control

Line contactor controlled by Power ON and Power OFF push-buttons or on detected error

This application diagram is well adapted to local control using inputs of ATS480. It requires a local intervention to restart after the error reset even in case of remote control: press **S3** push button to restart. Use relay output R1 set to **[Operating State Fault]** (factory setting) to turn Off the soft starter when an error is detected.

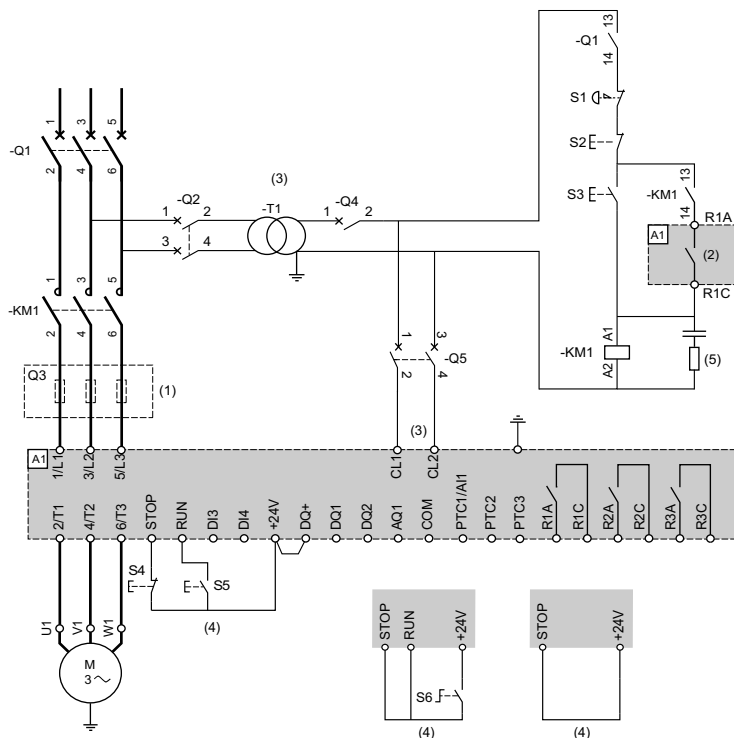

- (1) Installation of additional fast-acting fuses is mandatory to upgrade to type 2 coordination according to IEC 60947-4-2.
- (2) Take into account the electrical characteristics of the relays, refer to Control Terminal Characteristics, page 54.
- (3) The transformer must supply 110...230 Vac +10% - 15%, 50/60Hz.
- (4) 3-wire control, 2-wire control and fieldbus control. Refer to RUN and STOP Management, page 56.
- (5) To select the appropriate voltage surge suppressor refer to Relay Contacts Wiring, page 58.

Designation	Component	Description
Q1	Circuit breaker	Short circuit protection device for the motor
Q2	Circuit breaker	Short circuit protection device for the primary of the transformer
Q3	Fast acting fuses	Short circuit protection device of the soft starter to be used only when type 2 coordination
Q4	Circuit breaker	Short circuit protection device for the secondary of the transformer
Q5	Circuit breaker	Short circuit protection device for the control part of the soft starter
KM1	Contactor	Line contactor
S1	Emergency Stop push-button	Emergency Stop to de-energized KM1 line contactor
S2	Normally close push-button	Power OFF
S3	Normally open push-button	Power ON
S4	Normally close contact push-button	STOP command for 3-wire control
S5	Normally open contact push-button	RUN command for 3-wire control
S6	Selector switch, 2 positions, stay-put, normally open contact	RUN/STOP command for 2-wire control

2. Connection In Line, With Line Contactor, No Bypass, Type 1 or 2 Coordination, 2-wire control

Line contactor controlled based on RUN & STOP or on detected error. Freewheel stop only.

Simplified application diagram for local control using inputs of ATS480. Use relay output R1 set to **[Isolating Relay] ISOL** to turn Off the soft starter when an error is detected or on STOP command.

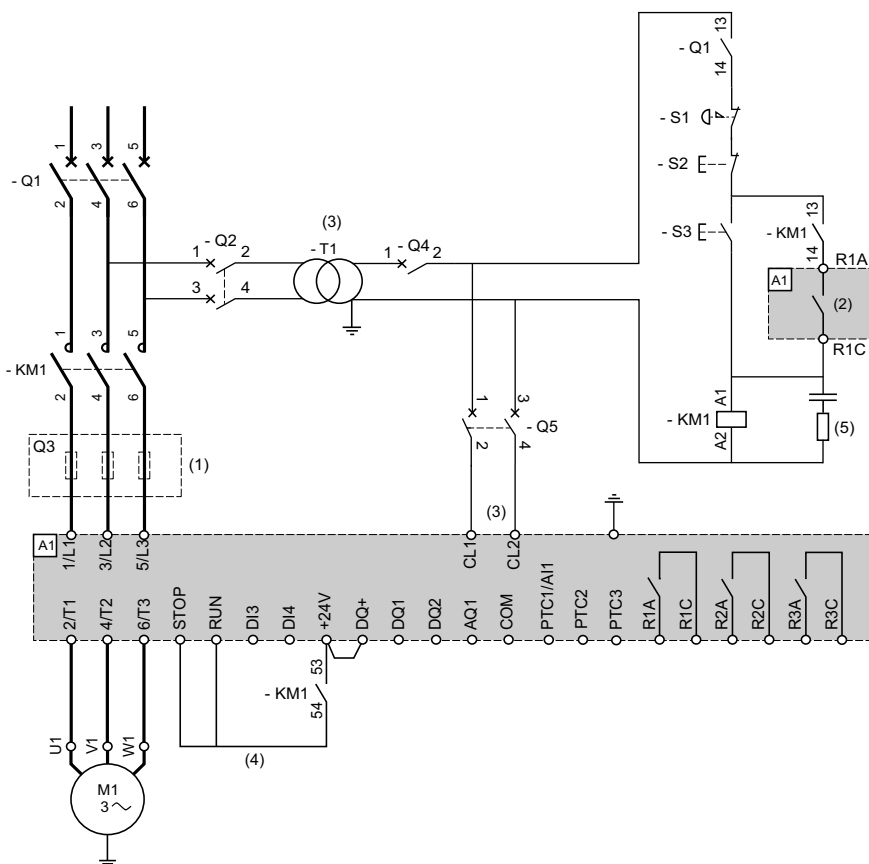

- (1) Installation of additional fast-acting fuses is mandatory to upgrade to type 2 coordination according to IEC 60947-4-2.
- (2) Take into account the electrical characteristics of the relays, refer to Control Terminal Characteristics, page 54.
- (3) The transformer must supply 110...230 Vac +10% - 15%, 50/60Hz.
- (4) 2-wire control. Refer to RUN and STOP Management, page 56.
- (5) To select the appropriate voltage surge suppressor refer to Relay Contacts Wiring, page 58.

Designation	Component	Description
Q1	Circuit breaker	Short circuit protection device for the motor
Q2	Circuit breaker	Short circuit protection device for the primary of the transformer
Q3	Fast acting fuses	Short circuit protection device of the soft starter to be used only when type 2 coordination according to IEC 60947-4-2 is required
Q4	Circuit breaker	Short circuit protection device for the secondary of the transformer
Q5	Circuit breaker	Short circuit protection device for the control part of the soft starter
KM1	Contactor	Line contactor
S1	Emergency Stop push-button	Emergency Stop to de-energized KM1 line contactor
S2	Normally close push-button	Power OFF and freewheel stop
S3	Normally open push-button	Power ON and Run order

3. Connection In Line, With Line and Bypass Contactor, Freewheel Or Controlled Stop, Type 1 or 2 Coordination, 2-wire or 3-wire

Line contactor controlled by Power ON and Power OFF push-buttons or detected error

This application diagram requires a local intervention to restart after the error reset even in case of remote control: press **S3** push button to restart. Use relay R1 set to **[Operating State Fault]** (factory setting) to turn Off the soft starter when an error is detected.

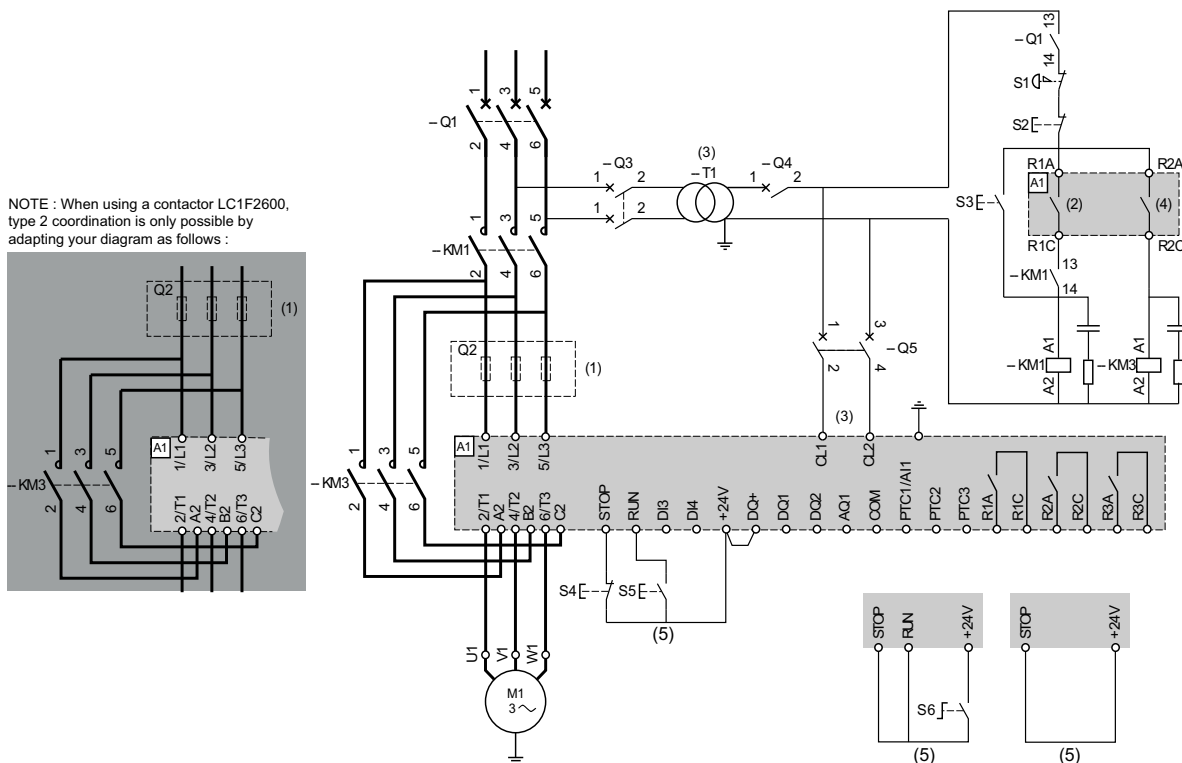

- (1) Installation of additional fast-acting fuses is mandatory to upgrade to type 2 coordination according to IEC 60947-4-2.
- (2) Take into account the electrical characteristics of the relays, refer to Control Terminal Characteristics, page 54
- (3) The transformer must supply 110...230 Vac +10% — 15%, 50/60Hz.
- (4) Take into account the electrical characteristics of the relays, especially when connecting to high rating contactor. Refer to Control Terminal Characteristics, page 54.
- (5) 3-wire control, 2-wire control and fieldbus control. Refer to RUN and STOP Management, page 56.
- To select the appropriate voltage surge suppressor refer to Relay Contacts Wiring, page 58.

Designation	Component	Description
Q1	Circuit breaker	Short circuit protection device for the motor
Q2	Fast acting fuses	Short circuit protection device of the soft starter to be used only when type 2 coordination
Q3	Circuit breaker	Short circuit protection device for the primary of the transformer
Q4	Circuit breaker	Short circuit protection device for the secondary of the transformer
Q5	Circuit breaker	Short circuit protection device for the control part of the soft starter
KM1	Contactor	Line contactor
S1	Emergency Stop push-button	Emergency Stop to de-energized KM1 line contactor
S2	Normally close push-button	Power OFF
S3	Normally open push-button	Power ON
S4	Normally close contact push-button	STOP command for 3-wire control and Power OFF
S5	Normally open contact push-button	RUN command for 3-wire control and Power On
S6	Selector switch, 2 positions, stay-put, normally open contact	RUN/STOP. command for 2-wire control

4. Connection In Line, With Line and Bypass Contactor, Freewheel Or Controlled Stop, Type 1 or 2 Coordination, 2-wire or 3-wire

Line contactor controlled based on RUN and STOP command or detected error

This application diagram does not require local intervention in case of remote control. Use relay output R1 set to [Isolating Relay] to turn Off the soft starter when an error is detected or on end of deceleration.

NOTE : When using a contactor LC1F2600, type 2 coordination is only possible by adapting your diagram as follows :

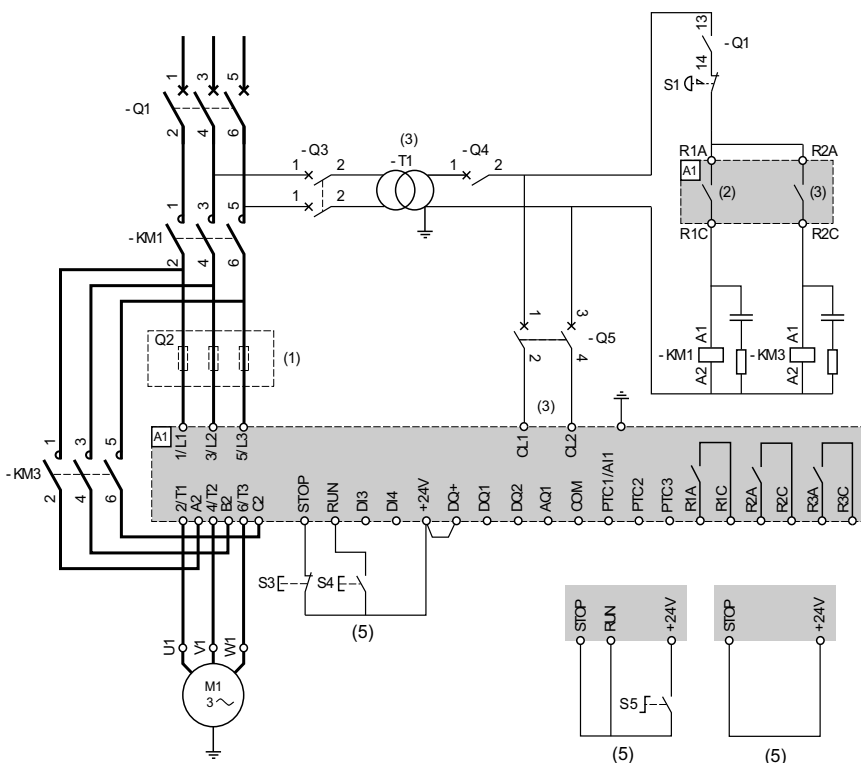
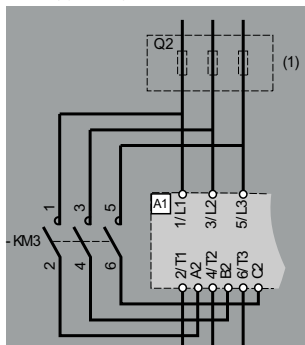

- (1) Installation of additional fast-acting fuses is mandatory to upgrade to type 2 coordination according to IEC 60947-4-2.
- (2) Take into account the electrical characteristics of the relays, refer to Control Terminal Characteristics, page 54
- (3) The transformer must supply 110...230 Vac +10% — 15%, 50/60Hz.
- (4) Take into account the electrical characteristics of the relays, especially when connecting to high rating contactor. Refer to Control Terminal Characteristics, page 54.
- (5) 3-wire control, 2-wire control and fieldbus control. Refer to RUN and STOP Management, page 56.
- To select the appropriate voltage surge suppressor refer to Relay Contacts Wiring, page 58.

Designation	Component	Description
Q1	Circuit breaker	Short circuit protection device for the motor
Q2	Fast acting fuses	Short circuit protection device of the soft starter to be used only when type 2 coordination
Q3	Circuit breaker	Short circuit protection device for the primary of the transformer
Q4	Circuit breaker	Short circuit protection device for the secondary of the transformer
Q5	Circuit breaker	Short circuit protection device for the control part of the soft starter
KM1	Contactors	Line contactor
S1	Emergency Stop push-button	Emergency Stop to de-energized KM1 line contactor
S3	Normally close contact push-button	STOP command for 3-wire control
S4	Normally open contact push-button	RUN command for 3-wire control
S5	Selector switch, 2 positions, stay-put, normally open contact	RUN/STOP. command for 2-wire control

5. Connection Inside the Delta, With Line and Bypass Contactor, Type 1 and 2 Coordination, 2-wire or 3-wire

Line contactor controlled based on RUN and STOP command or detected error

This application diagram requires a local intervention to restart after the error reset even in case of remote control: press **S3** push button to restart. Use relay output R1 set to **[Operating State Fault]** (factory setting) to turn Off the soft starter when an error is detected. Set **[Inside Delta]** to **[Yes]**.

NOTE : When using a contactor LC1F2600, type 2 coordination is only possible by adapting your diagram as follows :

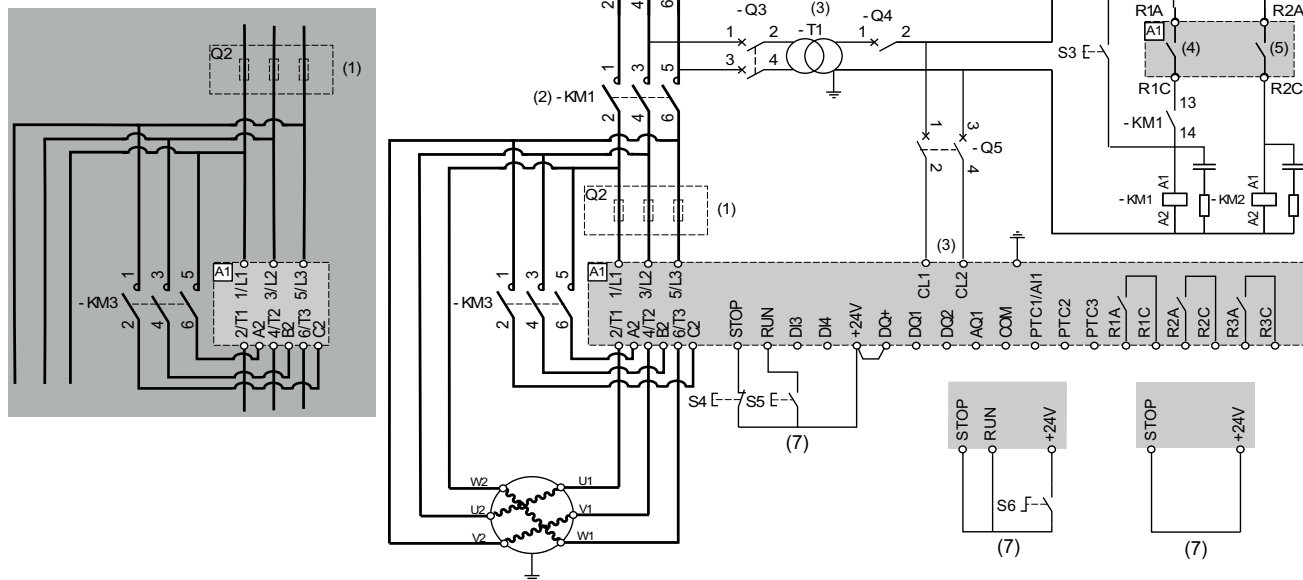

- (1) Installation of additional fast-acting fuses is mandatory to upgrade to type 2 coordination according to IEC 60947-4-2.
- (2) KM1 is mandatory to avoid uncontrolled voltage on the motor
- (3) The transformer must supply 110...230 Vac +10% — 15%, 50/60Hz.
- (4) (5) Take into account the electrical characteristics of the relays, especially when connecting to high rating contactor. Refer to Control Terminal Characteristics, page 54.
- (6) 3-wire control, 2-wire control and fieldbus control. Refer to RUN and STOP Management, page 56.
- To select the appropriate voltage surge suppressor refer to Relay Contacts Wiring, page 58.

Designation	Component	Description
Q1	Circuit breaker	Short circuit protection device for the motor
Q2	Fast acting fuses	Short circuit protection device of the soft starter to be used only when type 2 coordination according to IEC 60947-4-2 is required
Q3	Circuit breaker	Short circuit protection device for the primary of the transformer
Q4	Circuit breaker	Short circuit protection device for the secondary of the transformer
Q5	Circuit breaker	Short circuit protection device for the control part of the soft starter
KM1	Contactor	Line contactor
S1	Emergency Stop push-button	Emergency Stop to de-energized KM1 line contactor
S2	Normally close push-button	Power OFF
S3	Normally close push-button	Power ON
S4	Normally close contact push-button	STOP command for 3-wire control
S5	Normally open contact push-button	RUN command for 3-wire control
S6	Selector switch, 2 positions, stay-put, normally open contact	RUN/STOP. command for 2-wire control

6. Connection Inside the Delta, With Line and Bypass Contactor, Type 1 or 2 Coordination, 2-wire or 3-wire

Line contactor controlled based on RUN and STOP command or detected error

This application diagram does not require local intervention in case of remote control. Use relay output R1 set to **[Isolating Relay]** to turn Off the soft starter when an error is detected or on STOP command. Set **[Inside Delta]** to **[Yes]**.

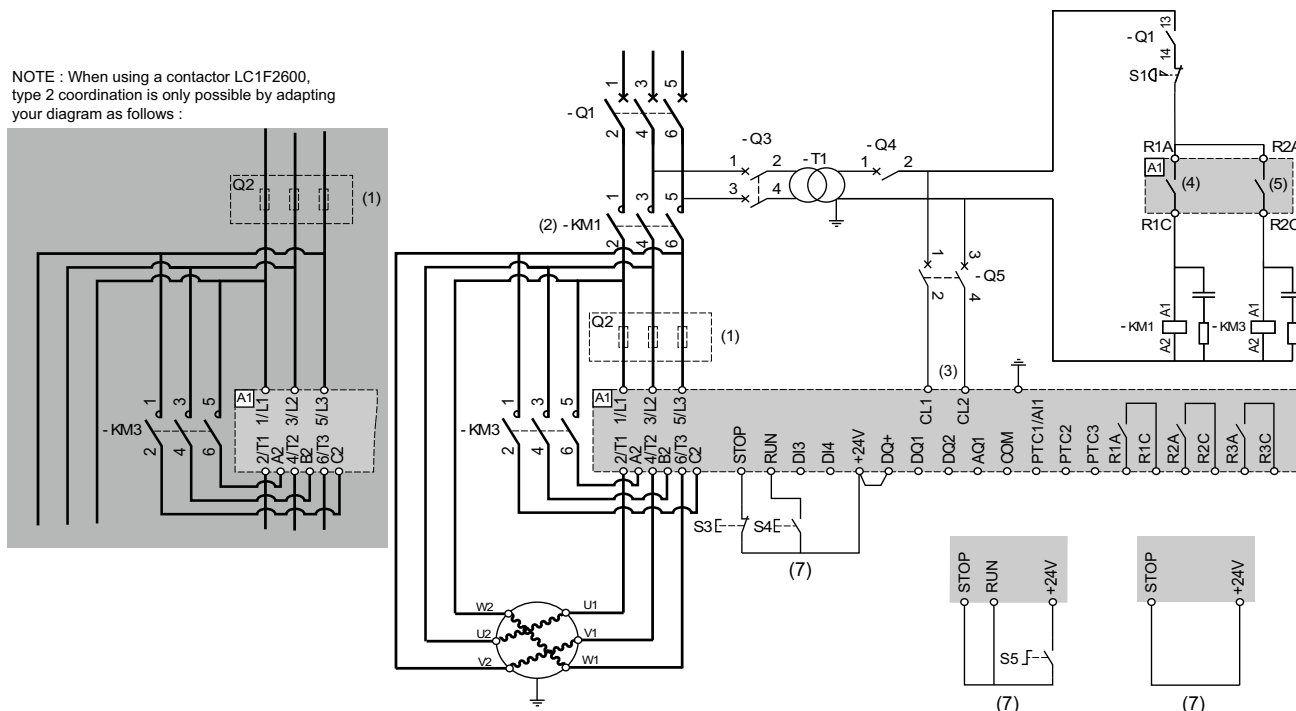

- (1) Installation of additional fast-acting fuses is mandatory to upgrade to type 2 coordination according to IEC 60947-4-2.
- (2) KM1 is mandatory to avoid uncontrolled voltage on the motor
- (3) The transformer must supply 110...230 Vac +10% — 15%, 50/60Hz.
- (4) Take into account the electrical characteristics of the relays, refer to Control Terminal Characteristics, page 54.
- (5) Take into account the electrical characteristics of the relays, especially when connecting to high rating contactor. Refer to Control Terminal Characteristics, page 54.
- (6) 3-wire control, 2-wire control and fieldbus control. Refer to RUN and STOP Management, page 56.
- To select the appropriate voltage surge suppressor refer to Relay Contacts Wiring, page 58.

Designation	Component	Description
Q1	Circuit breaker	Short circuit protection device for the motor
Q2	Fast acting fuses	Short circuit protection device of the soft starter to be used only when type 2 coordination
Q3	Circuit breaker	Short circuit protection device for the primary of the transformer
Q4	Circuit breaker	Short circuit protection device for the secondary of the transformer
Q5	Circuit breaker	Short circuit protection device for the control part of the soft starter
KM1	Contacteur	Line contactor
S1	Emergency Stop push-button	Emergency Stop to de-energized KM1 line contactor
S3	Normally close contact push-button	STOP command for 3-wire control and power Off
S4	Normally open contact push-button	RUN command for 3-wire control and power On
S5	Selector switch, 2 positions, stay-put, normally open contact	RUN/STOP command for 2-wire control

7. Connection to a Two Speeds Motor With Two Sets of Parameters, Line and Bypass Contactor, Type 1 or 2 Coordination, 2-wire Control

Line contactor controlled based on RUN and STOP command or detected error

Use relay output R1 set to [Isolating Relay] to turn Off the soft starter when an error is detected or on STOP command. Set DI3 to [2nd Mot Param Set].

NOTE : When using a contactor LC1F2600, type 2 coordination is only possible by adapting your diagram as follows :

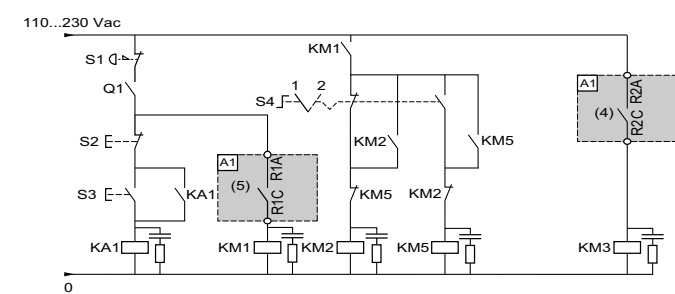
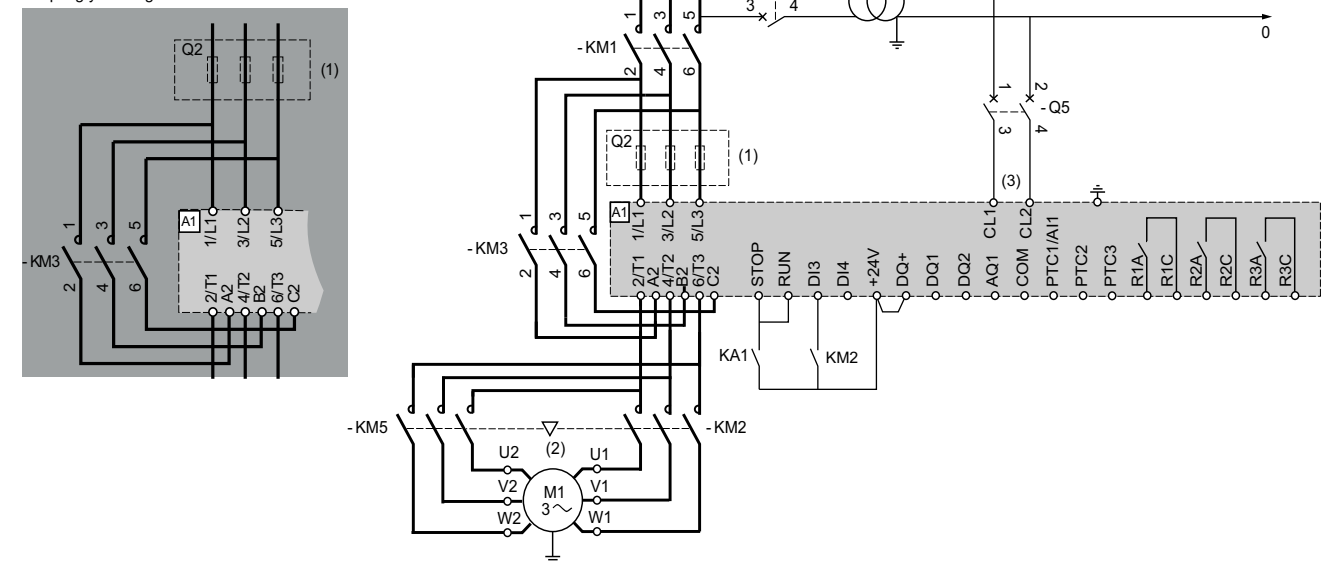

- (1) Installation of additional fast-acting fuses is mandatory to upgrade to type 2 coordination according to IEC 60947-4-2.
- (2) Ensure that the directions of motor rotation correspond for both speeds.
- (3) The transformer must supply 110...230 Vac +10% — 15%, 50/60Hz.
- (4) Take into account the electrical characteristics of the relays, especially when connecting to high rating contactor. Refer to Control Terminal Characteristics, page 54.
- (5) Take into account the electrical characteristics of the relays, Refer to Control Terminal Characteristics, page 54.
- To select the appropriate voltage surge suppressor refer to Relay Contacts Wiring, page 58.

Designation	Component	Description
Q1	Circuit breaker	SCPD for the motor
Q2	Fast acting fuses	SCPD of the soft starter to be used only when type 2 coordination
Q3	Circuit breaker	SCPD for the primary of the transformer
Q4	Circuit breaker	SCPD for the secondary of the transformer
Q5	Circuit breaker	SCPD for the control part of the soft starter
KM1	Contactor	Line contactor
KM2	Contactor	Low speed contactor

Designation	Component	Description
KM3	Contactor	By-pass contactor
KM5	Contactor	High speed contactor
S1	Emergency Stop push-button	Emergency Stop to de-energized KM1 line contactor
S2	Normally close push-button	Power OFF
S3	Normally open contact push-button	Power ON
S4	Selector switch, 2 positions, stay-put	Position 1 = Low Speed Position 2 = High Speed

Types of coordination

The EN/IEC 60947-4-1 make a distinction between two different types of coordination, which are designated coordination type 1 and coordination type 2.

Type 1 coordination:

Type 1 coordination requires that, under short-circuit conditions, the contactor or starter shall cause no danger to persons or installation and may not be suitable for further service without repair and replacement of parts.

Type 2 coordination:

Type 2 coordination requires that, under short-circuit conditions, the contactor or starter shall cause no danger to persons or installation and shall be suitable for further use. The risk of contact welding is recognized, in which case the manufacturer shall indicate the measures to be taken as regards the maintenance of the equipment.

NOTE: Use of an SCPD not in compliance with the manufacturer's recommendations can invalidate the coordination.

Refer to the Schneider Electric Catalogue to select the appropriate coordination components.

Checking Installation

Check List: Before Switching On

Unsuitable settings or unsuitable data or unsuitable wiring may trigger unintended movements, trigger signals, damage parts and disable monitoring functions.

▲ WARNING	
UNANTICIPATED EQUIPMENT OPERATION	
<ul style="list-style-type: none">• Only start the system if there are no persons or obstructions in the zone of operation.• Verify that a functioning emergency stop push-button is within reach of all persons involved in the operation.• Do not operate the product with unknown settings or data.• Verify that the wiring is appropriate for the settings.• Never modify a parameter unless you fully understand the parameter and all effects of the modification.• When commissioning, carefully run tests for all operating states, operating conditions and potential error situations.• Anticipate movements in unintended directions or oscillation of the motor.	
Failure to follow these instructions can result in death, serious injury, or equipment damage.	

Check List: Mechanical Installation

Verify the mechanical installation of the entire soft starter system:

Step	Action	✓
1	Does the installation meet the specified distance requirements?	
2	Did you tighten all fastening screws according to the specified tightening torque?	

Check List: Electrical Installation

Verify the electrical connections and the wiring:

Step	Action	✓
1	Did you connect all protective Ground conductors?	
2	The correct tightening of the screws may be altered during assembly and wiring phases of the soft starter. Verify and adjust the tightening of all terminal screws to the specified nominal torque.	
3	Do all fuses and circuit breaker have the correct rating; are the fuses of the specified type? Refer to the information provided in the catalog.	
4	Did you connect or insulate all wires at the cable ends?	
5	Did you properly separate and insulate the control and power wiring?	
6	Did you properly connect and install all cables and connectors?	
7	Did you properly connect the signal wires?	
8	Are the required shield connections EMC-compliant?	
9	Did you take all measures for EMC compliance?	
10	Did you confirm that CL1/CL2 terminals are only supplied with 110...230 Vac?	
11	Did you confirm that the output of the relays R1 R2 and R3 are only connected to a maximum voltage of 250Vac / 30Vdc?	

Check List: Covers and Seals

Verify that all devices, doors and covers of cabinet are properly installed to meet the required degree of protection.

Cybersecurity

What's in This Part

Overview	73
Password	85
Security Event Logging	87
Upgrades Management	89
Clear Device / Secure Decommissioning	90

Overview

What's in This Chapter

Security Policy 77
 Product Defense-in-Depth..... 78
 ATS480 Security Policy..... 80
 Potential Risks and Compensating Controls 83
 Data Flow Restriction..... 84

Title of documentation	Catalog number
Video: How to configure the cybersecurity applied to ATS480?	FAQ000236206 (English)
Recommended Cybersecurity Best Practices	7EN52-0390 (English)

The objective of Cybersecurity is to help provide increased levels of protection for information and physical assets from theft, corruption, misuse, or accidents while maintaining access for their intended users.

No single Cybersecurity approach is adequate. Schneider Electric recommends a defense-in-depth approach. Conceived by the National Security Agency (NSA), this approach layers the network with security features, appliances, and processes.

The basic components of this approach are:

- Risk assessment
- A security plan built on the results of the risk assessment
- A multi-phase training campaign
- Physical separation of the industrial networks from enterprise networks using a demilitarized zone (DMZ) and the use of firewalls and routing to establish other security zones
- System access control
- Device hardening
- Network monitoring and maintenance

This chapter defines the elements that help you configure a system that is less susceptible to cyber-attacks.

Network administrators, system integrators and personnel that commission, maintain or dispose of a device should:

- Apply and maintain the device's security capabilities. See Device Security Capabilities sub-chapter for details.
- Review assumptions about protected environments. See Protected Environment Assumptions sub-chapter for details.
- Address potential risks and mitigation strategies. See Product Defense-in-Depth sub-chapter for details.
- Follow recommendations to optimize cybersecurity.

For detailed information on the system defense-in-depth approach, refer to the TVDA: How Can I Reduce Vulnerability to Cyber Attacks (STN V3.0) on se.com.

To submit a Cybersecurity question, report security issues, or get the latest news from Schneider Electric, visit the [Schneider Electric website](#).

⚠ WARNING

POTENTIAL COMPROMISE OF SYSTEM AVAILABILITY, INTEGRITY, AND CONFIDENTIALITY

- Change default password to help prevent unauthorized access to device settings and information.
- Disable unused ports/services and default accounts, where possible, to minimize pathways for malicious attacks.
- Place networked devices behind multiple layers of cyber defenses (such as firewalls, network segmentation, and network intrusion detection and protection).
- Use cybersecurity best practices (for example: least rights, separation of duties) to help prevent unauthorized exposure, loss or modification of data and logs, interruption of services, or unintended operation.

Failure to follow these instructions can result in death, serious injury, or equipment damage.

Also, a video [How to configure the cybersecurity applied to ATS480?](#), page 15 is available.

Protected Environment Assumptions

Machines, controllers, and related equipment are usually integrated into networks. Unauthorized persons and malware may gain access to the machine as well as to other devices on the network/fieldbus of the machine and connected networks via insufficiently secure access to software and networks.

▲ WARNING

UNAUTHORIZED ACCESS TO THE MACHINE VIA SOFTWARE AND NETWORKS

- In your hazard and risk analysis, consider all hazards that result from access to and operation on the network/fieldbus and develop an appropriate cybersecurity concept.
- Verify that the hardware infrastructure and the software infrastructure into which the machine is integrated as well as all organizational measures and rules covering access to this infrastructure consider the results of the hazard and risk analysis and are implemented according to best practices and standards covering IT security and cybersecurity (such as: ISO/IEC 27000 series, Common Criteria for Information Technology Security Evaluation, ISO/IEC 15408, IEC 62351, ISA/IEC 62443, NIST Cybersecurity Framework, Information Security Forum - Standard of Good Practice for Information Security, SE recommended Cybersecurity Best Practices*).
- Verify the effectiveness of your IT security and cybersecurity systems using appropriate, proven methods.

Failure to follow these instructions can result in death, serious injury, or equipment damage.

(*) : SE Recommended Cybersecurity Best Practices can be downloaded on SE.com.

Additionally, use a layered network approach with multiple security and defense controls in your IT and control system to minimize data protection gaps, reduce single-points of failure and create a strong cybersecurity posture. The more layers of security in your network, the harder it is to breach defenses, take digital assets or cause disruption.

Control System - Cybersecurity policy

- Cybersecurity governance – available and up-to-date guidance on governing the use of information and technology assets in your company that is matching with a dedicated risk analysis about the control system
- The access control policy defined in the cybersecurity governance is strictly applied. In particular, it guarantees the authenticity of privileged operations. For example operations that can alter the critical assets.
- The instructions and procedures should structure the roles and responsibilities in terms of security within the organization; in other words, who is authorized to perform what and when. These should be known by the users.
- Define information security continuous monitoring (ISCM) to maintain the awareness of information security, vulnerabilities and threats to your organization.
- Perform patch management by applying security patches from vendor to ensure stability and completeness.

Physical perimeter security

- Set up the devices in an enclosed area with physical access control to prevent unauthorized access to the device, with dedicated monitoring

Physical network segmentation

Independence from non-control system networks – the control system provides network services to control system networks, critical or non-critical, without a connection to non-control system networks

- Physically segment control system networks from non-control system network
- Physically segment critical control system networks from non-critical control system networks

Logical isolation of critical networks

The control system provides the capability to logically and physically isolate critical control system networks from non-critical control system networks. For example, using VLANs.

Zone boundary protection – the control system provides the capability to:

- Manage connections through managed interfaces consisting of appropriate boundary protection devices, such as: proxies, gateways, routers, firewalls, and encrypted tunnels
- Use an effective architecture, for example, firewalls protecting application gateways residing in a DMZ
- Control system boundary protections at any designated alternate processing sites should provide the same levels of protection as that of the primary site, for example, data centers

No public internet connectivity – access from the control system to the internet is not recommended

Information disclosure prevention

- Encrypt protocol transmissions over all external connections using an encrypted tunnel, TLS wrapper or a similar solution
- Reduce access to control system information by distributing permissions according to predefined access control with least privilege practices

Control against malware

- Detection, prevention, and recovery controls to help protect against malware are implemented and combined with appropriate user awareness
- Any computer in use on the control system either on premise or temporarily connected, should have an updated anti-virus, anti-malware, anti-ransomware application activated during the use

Resource & control system availability

- Ensure continuity of service – ability to break the connections between different network segments or use duplicate devices in response to an incident. RSTP, redundancy of controllers or network device like switches or similar solution.
- Manage communication loads – the control system provides the capability to manage communication loads to mitigate the effects of information flooding types of DoS (Denial of Service) events
- Manage the retention cycles of data and programs with the retention periods determined as appropriate. FDR can be used for instance.

Security Policy

⚠ WARNING

ACCESSIBILITY LOSS

- Setup a security policy to your device and backup the device image with security administrator user account.
- Define and regularly review the password policy.
- Periodic change of the passwords, Schneider Electric recommends a modification of the password each 90 days.

Failure to follow these instructions can result in death, serious injury, or equipment damage.

Cybersecurity helps to provide:

- Confidentiality (to help prevent unauthorized access)
- Integrity (to help prevent unauthorized modification)
- Availability/authentication (preventing the denial of service and assuring authorized access)
- Non-repudiation (preventing the denial of an action that took place)
- Traceability/detection (logging and monitoring)

Norm IEC 62443 is the worldwide standard for security of industrial control system (ICS) networks.

From the norm definition, Altivar Soft Starter ATS480 is considered as Embedded Device of the ICS network, and has been designed following the norm IEC62443-4-1 and the technical security requirements are defined in compliance with norm IEC 62443-4-2.

Altivar Soft Starter ATS480 security features prevent the unauthorized disclosure of information via eavesdropping or casual exposure.

For an efficient security, the instructions and procedures should structure the roles and responsibilities in terms of security within the organization; in other words, who is authorized to perform what and when. These should be known by the users.

The anti-intrusion and anti-physical access to any sensitive installation should be set up.

All the security rules implemented in the ATS480 are in complement of the points above.

The device does not have the capability to transmit data encrypted using the following protocols: HTTP, Modbus slave over serial, Modbus slave over Ethernet, EtherNet/IP, SNMP, SNTIP. If other users gained access to your network, transmitted information can be disclosed or subject to tampering.

⚠ WARNING
<p>CYBERSECURITY HAZARD</p> <ul style="list-style-type: none"> For transmitting data over an internal network, physically or logically segment the network, the access to the internal network needs to be restricted by using standard controls such as firewalls. For transmitting data over an external network, encrypt protocol transmissions over all external connections using an encrypted tunnel, TLS wrapper or a similar solution. <p>Failure to follow these instructions can result in death, serious injury, or equipment damage.</p>

The access through the digital inputs is not controlled.

Any computer using SoMove, DTM, Webserver or EcoStruxure Control Expert should have an updated anti-virus, anti-malware, anti-ransomware application activated during the use.

The ATS480 have the capability to export its settings and files manually or automatically. It is recommended to archive any settings and files (device backup images, device configuration, device security policies) in a secure area.

Product Defense-in-Depth

Use a layered network approach with multiple security and defense controls in your IT and control system to minimize data protection gaps, reduce single-points of failure and create a strong cybersecurity posture. The more layers of security in your network, the harder it is to breach defenses, take digital assets or cause disruption.

Altivar Soft Starter ATS480 offers the following security features:

Threats	Desired security property on Embedded Device	ATS480 security features
Information disclosure	Confidentiality	Password encrypted in a non-reversible way
		User access control
Tampering	Device integrity	Cryptographic signature of firmware package
		Secure root of trust
Denial of Service	Availability	Device backup/restore
		Security export/import
		Achilles Level 2
Spoofing/Elevation of privilege	User Authenticity / Authorization	Strong password policy
		Access control commissioning tools Modbus Serial
		Access control local Keypad
		Access control commissioning tools Modbus TCP
Repudiation	Non-repudiability	Access control commissioning tools WebServer
		Secure event logging

Confidentiality

Information confidentiality capacity prevents unauthorized access to the device and information disclosure.

- The user access control helps on managing users that are authorized to access the device. Protect user credential at usage.
- The user's passwords are encrypted in non-reversible way at rest

Information affecting the security policy of the device is encrypted in transit over Ethernet when cyber is activated.

Device Integrity Protection

The device integrity protection prevents unauthorized modification of the device with tampered or spoofed information.

This security capability helps protect the authenticity and integrity of the firmware running on the ATS480 and facilitates protected file transfer: digitally signed firmware is used to help protect the authenticity of the firmware running on the ATS480 and only allows firmware generated and signed by Schneider Electric.

- Cryptographic signature of the firmware package executed at the firmware update
- Secure root of trust ensures integrity and authenticity of the device firmware at each power-up

Availability

The control system backup is essential for recovery from a control system failure and/or misconfiguration and participate on preventing denial of service. It also helps ensure global availability of the device by reducing operator overhead on security application/deployment.

These security capabilities help manage control system backup with the device:

- Independent security policy import/export for local secure backup and security policy sharing with other devices.
- Complete device backup/restore available on local HMI and DTM.

Communication robustness, the ATS480 Ethernet fieldbus module successfully passed the certification Achilles L2.

Authentication and Authorization

The user authentication helps prevent the repudiation issue by managing user identification and prevents information disclosure and device integrity issues by unauthorized users.

These security capabilities help enforce authorizations assigned to users, segregation of duties and least rights:

- User authentication is used to identify and authenticate software processes and devices managing accounts
- Device Password policy and password strength configurable using SoMove and DTM or EcoStruxure Control Expert
- Authorization managed according to channels

In line with user authentication and authorization, the device has access control cryptographic features to check user credential before access is granted to the system.

In the ATS480, the control of accessibility to the settings, parameters, configuration, and logging database is done with a user authentication after "Log in", with a name and password.

The ATS480 controls the access through:

- SoMove DTM (Serial and Ethernet connection)
- The webserver (Ethernet option required)
- EcoStruxure Control Expert
- EADM (EcoStruxure Automation Device Maintenance)

Security Event Logging

The security event logging prevents the repudiation issues by ensuring traceability and detection of any service executed and affecting the security policy of the device.

These security capabilities support the analysis of security events, help protect the device from unauthorized alteration and records configuration changes and user account events:

- Human-readable reports for device security settings
- Audit event logs to identify:
 - The ATS480 security configuration modification
 - The device users' activity (e.g. login, logout)
 - The device firmware updates
 - Audit storage capacity of 500 security event logs
 - Timestamps, including date and time, match ATS480 clock

ATS480 Security Policy

To facilitate cybersecurity first configurations, the ATS480 offers 2 security policies with preset ATS480 security features. This operation applies default values adapted to the security level targeted by the system of which the device is part.

Selection of these 2 security policies can be done upon first power up of the device, both with the display terminal (Refer to [First Power-Up](#), page 100 for more information) and Commissioning tool (DTM).

Security Policy “Minimum”

This profile offers a minimum of cybersecurity features. The user access control (login & password check at connection) are disabled on SoMove, EcoStruxure Control Expert, and WebServer.

Those connections remain unsecured and open for potential elevation of privilege. This profile is to be used for installation where authentication & authorization constraints are covered by access control mitigation external to the device.

When Minimum policy is selected, each user accessing the device is considered to have some ADMIN role and privileges.

Security Policy “Advanced”

This profile presets the device security by enabling security features. The user access control is enabled for SoMove, EcoStruxure Control Expert, and WebServer.

When activating the “Advanced” security policy, the user is identified as ADMIN and is requested to create a login and a password unique to the device.

A default password is displayed on the display terminal. It can be kept as it is or modified.

Refer to the following cybersecurity features summary per security policy:

ATS480 security feature	Open for configuration (activation or settings)	Preset security policy	
		Minimum	Advanced
Password encrypted in a non-reversible way	-	-	✓
User access control	-	-	✓
Cryptographic signature of firmware package	-	✓	✓
Secure root of trust	-	✓	✓
Device backup	ADMIN only	✓	✓
Device restore	ADMIN only	✓	✓
Security Save	ADMIN only	✓	✓
Security Restore	ADMIN only	✓	✓
User management	ADMIN only	✓	✓
Achilles	-	✓	✓
Strong password policy	ADMIN only	-	✓
Access control: <ul style="list-style-type: none"> • Commissioning tools (Modbus Serial and TCP) • Webserver 	ADMIN only	✓	✓
Secure event logging	-	✓	✓

Import / Export Security Policy

The device security settings can be exported from a device to be archived and/or applied in the same or another device. The result of a security policy export consists in the creation of a security policy file. This file is identified with the extension .secp.

The following table describes the security settings included in the security policy export:

Security settings	Included in import / export operation
User access control settings	✔
Password policy	✔
User database, including username and password according to the configuration	✔
Password history, last 5 for each users	✔
Device default password	For security reasons, the default password is unique to each device and cannot be exported
Security events	The security events base is private property of a device and cannot be applied to another device

Potential Risks and Compensating Controls

Address potential risks using these compensating controls:

Area	Issue	Risk	Compensating controls
User accounts.	Default account settings are often the source of unauthorized access by malicious users.	If you do not change default password or disable the user access control, unauthorized access can occur.	Ensure User access control is enabled on all the communication ports and change the default passwords to help reduce unauthorized access to your device.
Secure protocols.	The device does not have the capability to transmit data encrypted using these protocols: <ul style="list-style-type: none"> • Modbus Serial • Modbus TCP • EtherNet/IP • SNMP • HTTP 	If a malicious user gained access to your network, they could intercept communication.	For transmitting data over internal network, physically or logically segment your network. For transmitting data over external network, encrypt protocol transmissions over all external connections using an encrypted tunnel, TLS wrapper or a similar solution. See Protected Environment Assumptions.

Data Flow Restriction

A firewall device is required to secure the access to the device and limit the data flow.

For detailed information, refer to the TVDA: How Can I Reduce Vulnerability to Cyber Attacks (STN V3.0).

Password

Default Password

The default password for user authentication can be accessed on Graphic Display Terminal via **Device Management > Cybersecurity > Default Password**

Changing Password

The user password can be changed from the DTM Admin options screen.

Reset Password

For ADMIN user, a special operation is available with the display terminal to reset the ADMIN password to a default value unique to the device.

To reset the ADMIN password:

Step	Action
1	Navigate to the menu [Device Management] → [Cybersecurity]
2	Scroll to the parameter [Reset Password] and press OK
3	The default password is visible on the display terminal until the ADMIN modifies it.

Upon first use, the commissioning tools and webserver will request the user to change this password prior to connecting. The cybersecurity policy does not change when the password is reset.

Password Policy

By default, the password policy of the Altivar Soft Starter ATS480 complies with IEEE 1686–2013 as following:

- 8 characters minimum with ASCII [32 to 122] characters
- At least one digit (0-9)
- At least one special character (@ % + ' ! # " \$ ^ ? : , () [] ~ _ . ; = & / \ - [SPACE])

In addition, for password changes, the password history is saved and prevents the reuse of a password that has been set at least once in the last 5 times.

The password policy can be customized or totally disabled to match with password policy defined in the system of which the device is part.

The following settings are available:

- Password policy: enabled/disabled. If disabled, a password is requested as authentication factor but there is no specific rule defined regarding the password robustness
- Password history: No restriction, Exclude last 3, Exclude last 5
- Special character required: YES/NO
- Numeric character required: YES/NO
- Alphabetic character required: YES/NO
- Minimum password length: any value between 6 and 20

This password policy customization can only be done with SoMove, DTM or EcoStruxure Control Expert. Please refer to DTM online help for details.

NOTE: Changing the User authentication security policy (elevation or reduction of privilege) will be taken into account:

- Upon next connection to the soft starter, if the Initial Setup connection is still open
- Immediately in other scenarios

Security Event Logging

The following time-stamped events are logged in a dedicated security log file:

- User authentications, authentication and logout attempts
- Security parameter changes
- Access to the security events
- Device reboot, startup
- Device hardware modifications and software updates
- Device Configuration Integrity changes (restore, download or factory settings)

The Altivar Soft Starter ATS480 can store up to 500 events, a warning is raised when the log base is reaching 90% of capacity. This warning can be acknowledged with commissioning tool (DTM). When the maximum capacity is reached, the 50 oldest events are erased.

If access control is disabled, any security event is identified as ADMIN action.

Embedded Device provides the capability to determine whether a given human took a particular action. The link is established between the user identifier, the action realized and the timestamping of the action (date and time) to provide an efficient source of security logging.

Irrelevant date & time can result in false interpretation of the security event logging and lead to either false positive or undetectable security threat detection.

<i>NOTICE</i>
WRONG TIMESTAMPING RESULT IN NON-REPUDIATION ISSUE <ul style="list-style-type: none">• Verify and regularly realign the synchronization of the device data & time. Failure to follow these instructions can result in equipment damage.

The security events can be read from SoMove, DTM and EcoStruxure Control Expert. For security reasons, security logs are stored in a database to which read-only access is provided. There is no possibility to edit or erase this log database.

The format system log record follows the syntax defined by Syslog RFC-5424 2009 and the semantic normalized by Schneider Electric.

Below is an example of this format:

```
<86>1 2022-01-24T09:59:53.06Z MyDevice ATS480 Credential USERACCOUNT_CHANGE [cred@3833 name="ADMIN"] Password changed
```

Elements from the example, from left to right	Syslog word	Description
<86>	PRI	Event priority (81 for alert events, 85 for notice events, 86 for informational events)
1	VERSION	Syslog protocol version
2022-01-24T09:59:53.06Z	TIMESTAMP	Date and time in UTC
MyDevice	HOSTNAME	Device name, or serial number if [Device Name] PAN is not defined
ATS480	APP-NAME	Product commercial reference
Credential	PROCID	Identify the process and the network protocol service that originated the message
USERACCOUNT_CHANGE	MSGID	Identify the type of event
[cred@3833 name="ADMIN"]	STRUCTURED-DATA	Event information depending on the event category: <ul style="list-style-type: none"> [authn@3833] [authz@3833] [config@3833] [cred@3833] [system@3833] [backup@3833]
Password changed	MSG	Message containing event specific information, if any

Upgrades Management

When the Altivar Soft Starter ATS480 firmware is upgraded, security configuration remains the same until changed, including usernames and passwords.

It is recommended that security configuration is reviewed after an upgrade to analyze rights for new or changed device features and revoke or apply them according to your company's policies and standards.

Clear Device / Secure Decommissioning

The device security policy can be totally erased. This operation is part of the device secure disposal use case executed during clear device operation. This operation can be done by ADMIN user only.

Upon execution, security settings are totally erased from the device, including any internal backup, usernames, passwords and history.

For security reasons, it is strongly recommended to perform this operation while removing the device from its intended environment.

To erase the device security policy go to one of those menu on the display terminal:

- **[Device Management] → [Backup/Restore]** and scroll to **[Clear device]**
- **[Device Management] → [Factory settings]** and scroll to **[Clear device]**

This parameter is visible in expert mode only. To active the expert mode go to the menu **[My preferences] → [Parameter access]** and set **[Access Level]** to **[Expert]**.

Commissioning

What's in This Part

Software and Tools	92
Product HMI	93
Soft Starter State	99
First Power-Up	100
Structure of the Parameter Table	105
Finding a Parameter in This Document	106
Main Menu Presentation	107
[Simply Start] <small>SYS</small>	108
Small Motor Test	117
Connection Inside The Delta Of The Motor	119
Diagnostic Of The Delta Connection	120
Motor Preheating	123
Torque / Voltage Control	128
Voltage Boost	129
Second Motor Parameters	131
Cascade Motors	134
Smoke Extraction	136
Factory Settings and Customer Configuration	138

Software and Tools

NOTE: Make sure that the latest version of the software and of the manuals are used.

SoMove



SoMove is a setup software for PC designed to configure Schneider Electric motor control devices. It incorporates functions for device setup, monitoring, fieldbus management and maintenance via a user-friendly interface.

To download SoMove go to [SoMove FDT](#).

To download the required DTM refer to [ATS480: DTM](#), page 14.

A contextual help for SoMove is available by pressing F1 on the keyboard.

Webserver



The VW3A3720 fieldbus module provides an integrated Web server which allows several functions like: monitoring, parameter settings, and diagnostics. The Web server can be accessed from standard browsers such as Microsoft Edge, Google Chrome, Firefox, etc.

For more information refer to the [ATS480 EtherNet/IP – Modbus TCP Manual](#), page 14.

EcoStruxure Automation Device Maintenance



The EcoStruxure Automation Device Maintenance software allows to update the firmware on multiple SE devices simultaneously.

To download EcoStruxure Automation Device Maintenance, go to [EADM](#).

EcoStruxure Control Expert



Control Expert is a setup software for PC designed to configure Schneider Electric Programmable Automation Controllers. It is compatible with Device DTM which allows in its interface to configure, to monitor, to manage and to maintain connected devices.

To download ControlExpert and the required DTM, refer to [ATS480: DTM](#), page 14.

Product HMI

What's in This Chapter

Display Terminals	94
Front Product LEDs	98

Display Terminals

Plain Text Display Terminal VW3A1113

This Plain Text Display Terminal is a local control unit plugged on the soft starter. The Display Terminal can be removed to be mounted on the door of the wall-mounted or floor-standing enclosure, using a dedicated door-mounting kit, refer to Mounting display terminal on the door of the enclosure, page 36. The Display Terminal communicates with the soft starter using Modbus serial link. Both embedded Modbus connections (Modbus HMI & Modbus Fieldbus) can be used but only one Display Terminal must be connected at the same time.

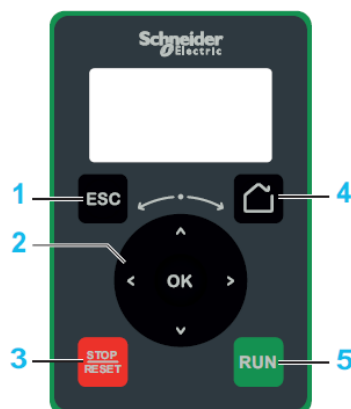

1. **ESC**: used to quit a menu/parameter, to clear the display of the triggered error or remove the currently displayed value in order to revert to the previous value retained in the memory
2. **Touch wheel / OK**: used to save the current value or access the selected menu/parameter. The touch wheel is used to scroll fast into the menus. Up/down arrows are used for precise selections, right/left arrows are used to select digits when setting a numerical value of a parameter.
3. **STOP / RESET**: stop command / apply a Fault Reset (a).
4. **Home**: used to access the home page.
5. **RUN**: executes the function (a).

(a) The function **RUN** of the **RUN** button and **RESET** of the **STOP / RESET** button are active only if the active command channel is the Display Terminal.

- **[Control Mode] CHCF** is set to **[Standard Profile] STD**
- **[Command Switching] CCS** is set to the channel commanding the display terminal

Example: Control via display terminal is active when **[Command Switching] CCS** is set to **[Cmd channel 1] CD1** and **[Cmd channel 1] CD1** is set to **[HMI] LCC**.



Key	
1	Display line.
2	Soft starter state, refer to Soft Starter State , page 99
3	Monitored parameter user defined. Can be configured in [My preferences] .
4	Active control channel <ul style="list-style-type: none"> • TERM: terminals • HMI: plain text display terminal • MDB: embedded Modbus serial • CAN: CANopen® • NET: Fieldbus module • PWS: DTM based commissioning software
5	Menu line: indicates the name of the current menu or submenu.
6	Menus, submenus, parameters, values, bar charts, and so on, are displayed in drop-down window format on a maximum of 2 lines. The line or value selected by the navigation button is displayed in reverse video.

Graphic Display Terminal VW3A1111

The Graphic Display Terminal is available as an optional Display Terminal and can be plugged like the Plain Text Display Terminal, using the Modbus HMI serial link connection. This Display Terminal can also be mounted on the door of the wall-mounted or floor-standing enclosure, refer to [Mounting display terminal on the door of the enclosure](#), page 36. Both embedded Modbus connections (Modbus HMI & Modbus Fieldbus) can be used but only one Graphic Display Terminal must be connected at the same time.

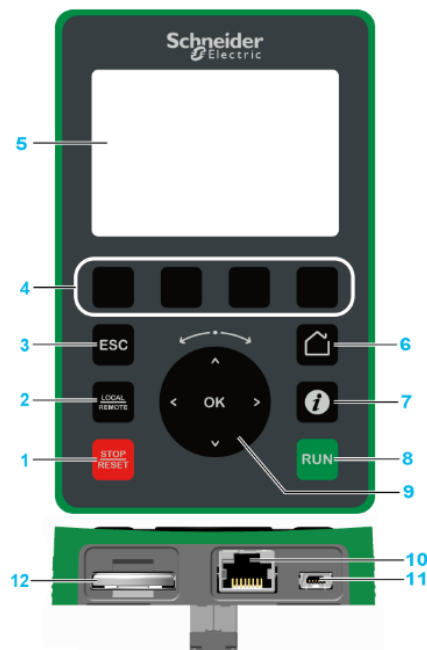

1. **STOP / RESET:** stop command / apply a Fault Reset (a).
2. **LOCAL / REMOTE:** used to switch between local and remote control of the soft starter. This button is disabled if **[HMI L/R cmd] BMP** is set to **[Disabled] DIS**, in the menu **[My preferences] MYP → [Customization] CUS**.
3. **ESC:** used to quit a menu/parameter, to clear the display of the triggered error or remove the currently displayed value in order to revert to the previous value retained in the memory
4. **F1 to F4:** function keys used to access soft starter id, QR code, quick view, and submenus. Simultaneous press of F1 and F4 keys generates a screenshot file in the Graphic Display Terminal internal memory.
5. **Graphic display.**
6. **Home:** used to access the home page.
7. **Information:** used to have more information about menus, submenus, and parameters. The selected parameter or menu code is displayed on the first line of the information page.
8. **RUN:** executes the function (a).
9. **Touch wheel / OK:** used to save the current value or access the selected menu/parameter. The touch wheel is used to scroll fast into the menus. Up/down arrows are used for precise selections, right/left arrows are used to select digits when setting a numerical value of a parameter.
10. **RJ45 Modbus serial port:** used to connect the Graphic Display Terminal to the soft starter in remote control.
11. **MiniB USB port:** used to connect the Graphic Display Terminal to a computer.
12. **Battery:** The battery have no use for the soft starter and there is no alarm for display terminal low battery level.

(a) The function **RUN** of the **RUN** button and **RESET** of the **STOP / RESET** button are active only if the active command channel is the Display Terminal.

- **[Control Mode]** **CHCF** is set to **[Standard Profile]** **STD**
- **[Command Switching]** **CCS** is set to the channel commanding the display terminal

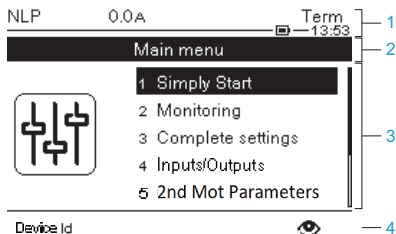

Key	
1	Display line.
2	Menu line: indicates the name of the current menu or submenu.
3	Menus, submenus, parameters, values, bar charts, and so on, are displayed in drop-down window format on a maximum of five lines. The line or value selected by the navigation button is displayed in reverse video.
4	Section displaying tabs (1 to 4 by menu), these tabs can be accessed using F1 to F4 keys

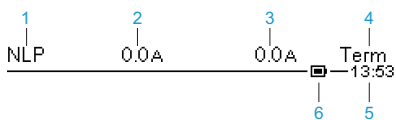

Key	
1	Soft starter state, refer to Soft Starter State, page 99.
2	Monitored parameter user defined, can be modified in [My preferences] .
3	Monitored parameter user defined, can be modified in [My preferences] .
4	Active control channel: <ul style="list-style-type: none"> • TERM: terminals • HMI: Graphic display terminal • MDB: integrated Modbus serial • CAN: CANopen® • NET: Fieldbus module • PWS: DTM based commissioning software
5	Present time.
6	Battery level. Level of battery embedded in the soft starter.

Graphic display terminal connected to a computer

The graphic display terminal is recognized as a USB storage device named SE_VW3A1111 while plugged into a computer.

This allows to access the saved soft starter configurations (DRVCONF folder) and the graphic display terminal screenshots (PRTSCR folder).

Screenshots can be stored by a simultaneous press on F1 and F4 functions keys.

Front Product LEDs

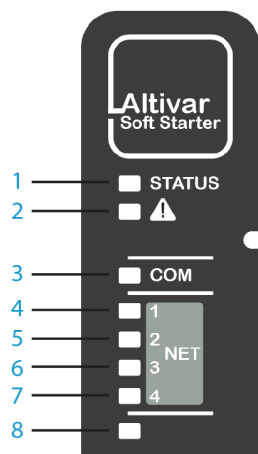

Item	LED	Color & status	Description
1	STATUS	OFF	Indicates that the soft starter is not ready to start
		Green flashing	Indicates that the soft starter is not running, ready to start
		Green blinking	Indicates that the soft starter is in transitory status (acceleration, deceleration, and so on)
		Green on	Indicates that the soft starter is running
		Yellow on	Indicates that the soft starter localization is in progress
2	Warning/Error	Red flashing	Indicates that the soft starter has detected a warning
		Red on	Indicates that the soft starter has detected an error
3	COM	Yellow flashing	Indicates embedded Modbus serial activity
4	NET 1	Green/Yellow	For details, refer to the fieldbus manual
5	NET 2	Green/Red	
6	NET 3	Green/Red	
7	NET 4	Green/Yellow	
8	Reserved		

Soft Starter State

List of possible soft starter states, visible on the Display Terminal.

State	Condition
Displayed error label	Detected error. The soft starter is in operating state Fault.
Monitoring parameter selected by the user with the [Display] SUP menu. Factory setting: [Motor Current] LCR	Displayed value on the display terminal when the soft starter is running.
[Ready] RDY	No RUN command and mains supplied.
[No Mains Voltage] NLP	No RUN command and mains not supplied.
[Ctrl Supply Loss] CLA	The warning [Ctrl Supply Loss] CLA triggers when control supply is lost, the soft starter is not running and [Control Supply Loss] CLB is set to [Warning] 2
[Running] RUN	Soft starter running.
[Bypassed] BYP	Bypass active
[Accelerating] ACC	Soft starter in acceleration phase.
[Decelerating] DEC	Soft starter in deceleration phase.
[Wait for Restart] TBS	Starting time delay not elapsed.
[Operating State "Fault"] FLT	Detected error. The soft starter is in operating state Fault.
[Freewheel] NST	Soft starter forced to freewheel stop by serial link.
[Braking In Prog] BRL	Soft starter in braking phase.
[Cascade Waiting] STB	Waiting for a command (RUN or STOP) in cascade mode.
[Current Limitation] CLI	Soft starter in current limitation.
[Motor Preheating] HEA	Motor preheating, correspond to one of the following step of the preheating sequence: <ul style="list-style-type: none"> • Preheating order applied but [Time Before Preheat] TPR not elapsed, no preheating current injected yet • Preheating order applied and [Time Before Preheat] TPR elapsed, preheating current is injected
[Small Motor Test] SST	Small motor test in progress
[Firmware Update] FWUP	Firmware update mode
[Demo Mode] DEMO	Demonstration mode active

When current limitation is active, the displayed value flashes.

It is still possible to modify the parameters if the soft starter detects an error.

First Power-Up

When powering-Up the ATS480 for the first time by applying 110.230 Vac on CL1 and CL2 terminals, before operating it is mandatory to :

Set the language

Select the language. It can be changed after this setup, for more details see 10.1 [Language] LNG, page 240.

Set the Time Zone and Set the Date and Time.

Check the set time zone, date and time.

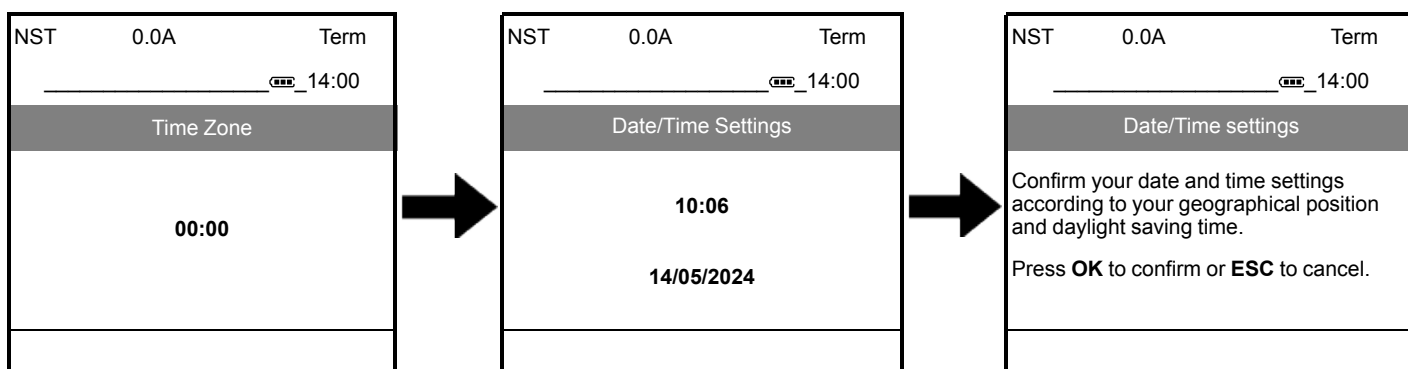

Press **OK** to confirm or **ESC** to cancel and return to the [Time Zone] screen.

Time Zone and Date and Time can be changed after this setup, for more details see 9.7 [Date & Time] DTO, page 232.

Go to product by setting cybersecurity policy (advanced, minimum)

To go into operational mode you need to configure the cybersecurity

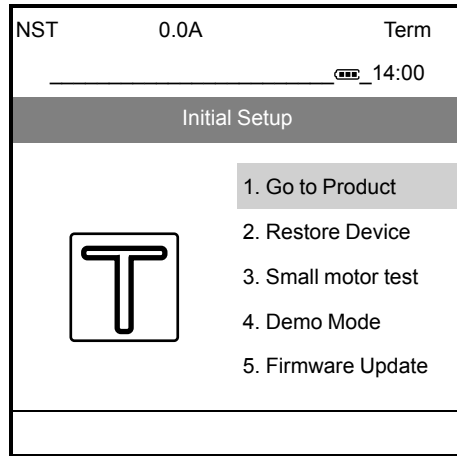

At the first power up, the soft starter ATS480 proposes minimum step-by-step settings in order to select the cybersecurity policy.

Step	Action
1	<ol style="list-style-type: none"> In the [Initial Setup] menu, scroll to [Go to product] and press OK. Choose a cybersecurity policy: <ul style="list-style-type: none"> To set no credentials to access this device, refer to step 2 – a. To set credentials, refer to step 2 – b. To load an existing cybersecurity policy already set and exported from a compatible device, refer to step 2 – c. <p>For more information about the cybersecurity policies, refer to <i>ATS480 Security Policy</i>, page 80.</p>
2 – a	<ol style="list-style-type: none"> Scroll to [Minimum Cybersec] and press OK. Read the message explaining the functionalities of this profile and press OK to validate and access the [Access Level] parameter or ESC to cancel the selection. Refer to 10.2 [Parameter access] PAC, page 241 to set your access level and access the main menu of the device. <p>Result: The device is ready to be commissioned.</p> <p>Disabling this feature, no credentials will be required to access your process or machine. This setting is saved with the configuration and will be active if a configuration is loaded or copied.</p> <div style="border: 1px solid black; padding: 10px; margin: 10px 0;"> <p style="text-align: center;">▲ WARNING</p> <p style="text-align: center;">UNAUTHENTICATED ACCESS AND MACHINE OPERATION</p> <p>Do not disable the feature if your machine or process is accessible to unauthorized personnel either directly or via a network.</p> <p>Failure to follow these instructions can result in death, serious injury, or equipment damage.</p> </div> <p>For more information about the cybersecurity policies, refer to <i>ATS480 Security Policy</i>, page 80.</p>

Step	Action
2 – b	<ol style="list-style-type: none"> 1. Scroll to [Advanced Cybersec] and press OK. 2. Set a password and press OK to confirm it or ESC to cancel the selection. 3. Verify the set credentials and press OK to confirm them or ESC to cancel the selection. 4. Scroll down to display the confirmation message, press OK to validate this cybersecurity policy and access the [Access Level] parameter or press ESC to cancel the selection. 5. Refer to 10.2 [Parameter access] PAC, page 241 to set your access level and access the main menu of the device. <p>Result: The device is ready to be commissioned.</p> <p>For more information about the cybersecurity policies, refer to ATS480 Security Policy, page 80.</p>
2 – c	<ol style="list-style-type: none"> 1. Scroll to [Load security policy] and press OK. 2. Scroll to the cybersecurity policy file (.secp) to upload on the device and press OK to transfer the file and access the [Access Level] parameter or ESC to cancel your selection. Refer to 9.6 [Cybersecurity] CYBS, page 229 for more information on soft starter configuration files. 3. Refer to 10.2 [Parameter access] PAC, page 241 to set your access level and access the main menu of the device. <p>For more information about the import / export of cybersecurity policies, refer to Import / Export Security Policy in ATS480 Security Policy, page 80.</p> <p>Result: The cybersecurity policy is set and the device is ready to be commissioned.</p>

NOTE: Once the steps are done (the cybersecurity policy is selected), the pre-operating procedure will not be required at the next power up and the device is ready for operation.

Restore a device configuration (Situational)

In case of a product replacement or a similar situation, it is possible to restore a configuration. Refer to 9.5 **[Backup/Restore]** BRDV, page 228 for more information.

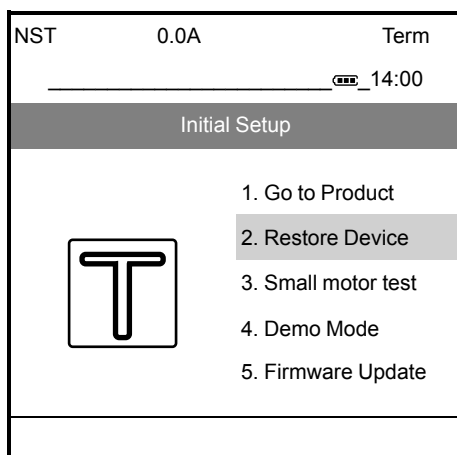

Step	Action
1	In the [Initial Setup] menu, scroll to [Restore device] and press OK .
2	Select [Load backup image] , press OK and select a .bki file. Refer to for more information on soft starter configuration files.
3	Read carefully the message on the display terminal and press OK to validate. Result: The device is ready to be commissioned. The previous device cybersecurity policy will be erased by this new configuration. For more information about the cybersecurity policies, refer to ATS480 Security Policy, page 80.

Perform a small motor test or a commercial demonstration (Situational)

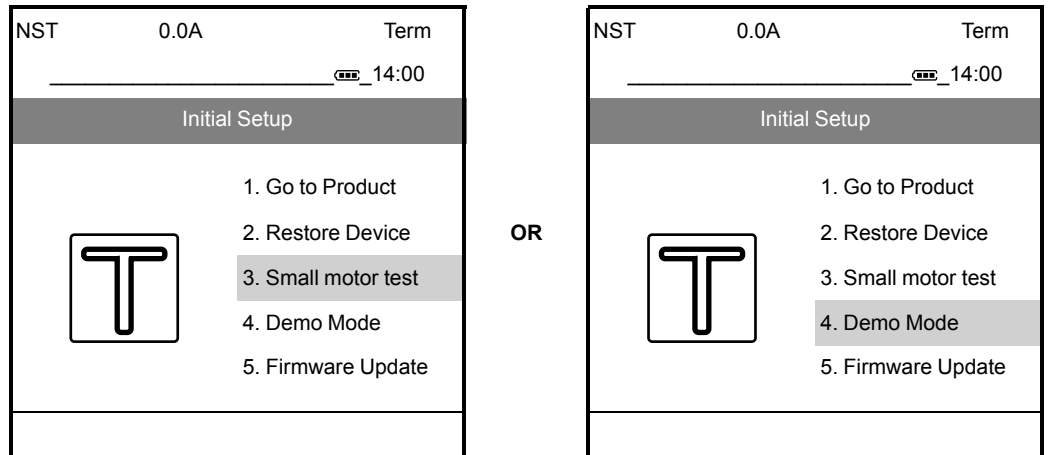

It is possible that in some cases, the user may not want or is not allowed to configure the cybersecurity or restore a device configuration.

For instance, when :

- Testing the soft starter mains supply wiring with **[Small Motor Test]**. For more details, refer to Small Motor Test, page 117.
- Performing a commercial demonstration of the soft starter for commercial purposes, by simulating a load and the presence of the mains supply without having to physically wire the product with **[Demo Mode]**. For more details, refer to 9.11 **[Simulation mode]** SIMU, page 237.

Check if the device is up to date (Situational)

It is possible to have a firmware package to be applied on the device.

Verify if there is a firmware update to apply by selecting **[Firmware update]** then Check for Update:

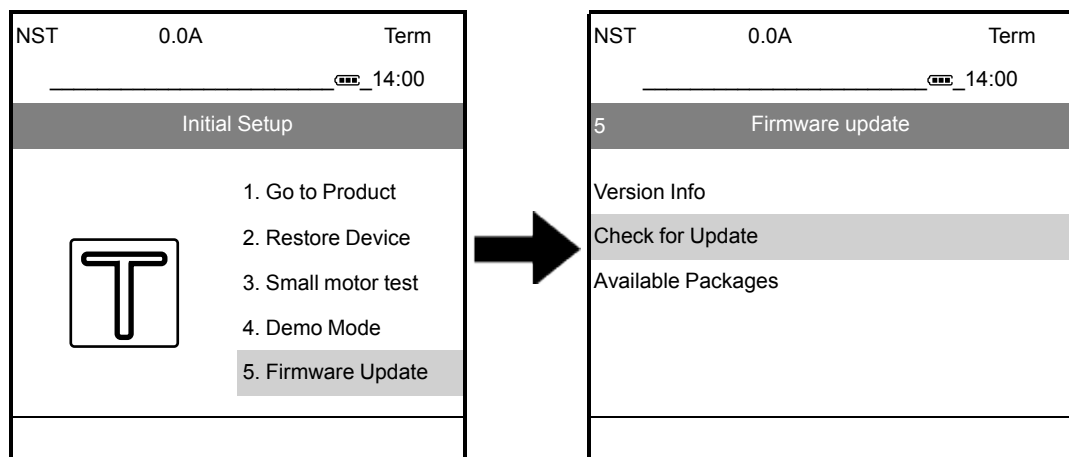

If the Product is up to date, two possibilities can appear:

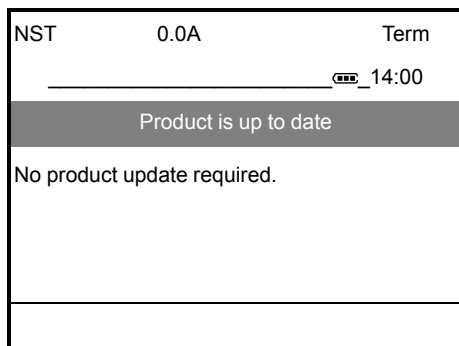

OR

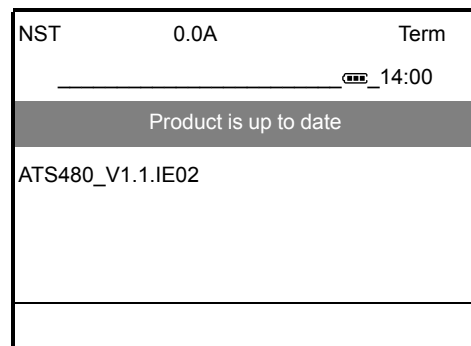





If firmware package is available, please follow this process:

Step	Action
1	Select the firmware package.
2	Apply the new firmware.
3	Pass through the Release Info step by pressing the OK button.
4	Pass through the FW UPDATE step by pressing the OK button.
5	These messages appear: <ol style="list-style-type: none"> 1. You are about to apply a new firmware. 2. Please wait for completion. 3. Product update is in progress. 4. Product restart in progress.
6	The final message "Firmware update has been correctly applied" appears. Press OK to continue the first power up procedure.

NOTE: To do a Firmware Update after your first power procedure, refer to 9.8 [Firmware update] FWUP, page 234

Structure of the Parameter Table



General Legend

Pictogram	Description
	This parameter can be set during operation or when stopped. NOTE: It is advisable to stop the motor before modifying any of the settings
	The motor must be stopped to set this parameter.
	Power cycle must be performed after setting this parameter.
	Read only parameter, mainly used for monitoring.
	Expert mode required to access this parameter.

Finding a Parameter in This Document

Display on HMI Tools

A parameter is identified by:











- Its short label displayed on the Plain Text Display Terminal, and on the Graphic Display Terminal
- Its long label displayed on SoMove DTM Parameter list tab, on the Graphic Display Terminal by pressing , and on the Webserver
- Its code displayed on SoMove DTM Parameter list tab, on the Graphic Display Terminal by pressing , and on the Webserver

Example: **[Acceleration]** is a short label, its code is **ACC** and its long label is ***Acceleration ramp time***.

With the Manual

It is possible to use either the parameter name or the parameter code to search in the manual the page giving details of the selected parameter.

Main Menu Presentation

 1 [Simply Start] <small>SYS</small>	Minimum parameters to start and stop a motor.
 2 [Monitoring] <small>PROT</small>	Electrical and thermal monitoring functions.
 3 [Complete settings] <small>CST</small>	Advanced settings for fine-tuning.
 4 [Input/Output] <small>IO</small>	Inputs/Outputs configuration.
 5 [2nd Mot Parameters] <small>ST2</small>	Second set of essential parameters.
 6 [Communication] <small>COM</small>	Fieldbus communication configuration.
 7 [Display] <small>MON</small>	Monitoring of key values.
 8 [Diagnostics] <small>DIA</small>	Soft starter history, current state and motor thermal state.
 9 [Device Management] <small>DMT</small>	Cybersecurity, time setting, firmware update and factory settings.
 10 [My preferences] <small>MYP</small>	Device and display terminal configuration.

[Simply Start] SYS

What's in This Chapter

Set The Currents	109
Set The Mains Voltage	111
Set Start Profile	112
Set Stop Profile	113
Example Of Typical Configurations For Common Applications	116

About this menu

The  **[Simply Start]** SYS menu provides:

- The minimum parameters to start and stop a class 10E induction motor in torque control.
- The list of parameters directly modified by the user via the display terminal in the **[Modified parameters]** LMD sub-menu. It is possible to edit the modified parameters from this sub-menu.

For typical configuration examples refer to Example Of Typical Configurations For Common Applications, page 116.

In this chapter it is assumed that the soft starter uses the torque control law command to pilot a motor wired in-line with the mains supply.

For other configuration, refer to the **[Complete settings]** CST menu.

[Simply Start] SYS menu navigation

1.1 [Simply start] SIM
<p>[Motor Nom Current] IN</p> <p>[Current Limit] ILT</p> <p>[Mains Voltage] ULN</p> <p>[Acceleration] ACC</p> <p>[Init Starting Torque] TQ0</p> <p>[Type of stop] STT</p> <p>[Deceleration] DEC</p> <p>[End Of Deceleration] EDC</p> <p>[Braking Level] BRC</p> <p>[DC Braking Time] EBA</p>
1.2 [Modified parameters] LMD
List of the edited parameters.

Set The Currents

The following parameters can be used to start smoothly and progressively a motor by limiting the current in the motor during the start and ramp-up. This reduces the current surge at the start, the mechanical stress on the motor and reduces potential overloading of the electrical distribution network.

The value set to **[Motor Nom Current]** IN determines the current of the motor thermal monitoring, depending on which motor class is set. For more information regarding the motor thermal monitoring and the selection of the motor class, refer to **[Monitoring]** PROT, page 143.

Step	Action
1	Set [Motor Nom Current] IN to the value of the nominal motor current indicated on the motor nameplate.
2	Set the current limitation with the [Current Limit] ILT parameter.

With the maximum load, the current limitation should be set at a high enough value to allow the motor to start. If the application requires more than 500% the soft starter current rating, a higher rated soft starter must be selected.

HMI navigation and parameters explanation

Access path: **[Simply Start]** SYS → **[Simply start]** SIM

Access path: **[Complete settings]** CST → **[Motor parameters]** MPA

HMI label	Setting	Factory setting
[Motor Nom Current] IN	–	(1)
<p>Nominal current</p> <p>Adjust the value of [Motor Nom Current] IN according to the rated motor current indicated on the motor nameplate even if the soft starter is wired in the motor delta.</p> <p>[Motor Nom Current] IN have two ranges of values:</p> <ul style="list-style-type: none"> • 0.4...1.3 of soft starter rating (Ie, rated operational current) [Inside Delta] DLT is set to [No] NO. If the rated motor current is below 0.4 Ie, use a lower rated soft starter. If above 1 Ie, the soft starter must be by-passed. • 0.69...2.25 of Ie if [Inside Delta] DLT is set to [Yes] YES. <p>The value set to [Motor Nom Current] IN determines the current of the motor thermal monitoring, depending on which motor class is set. For more information regarding the motor thermal monitoring and the selection of the motor class, refer to 2 [Monitoring] PROT, page 143.</p> <p>For more information about [Inside Delta] DLT refer to Connection Inside The Delta Of The Motor, page 119.</p> <p>(1) Factory setting of [Motor Nom Current] IN corresponding to the usual value of a 4-pole 400 V standardized induction motor and [Inside Delta] DLT is set to [No] NO (soft starter connected in-line).</p>		

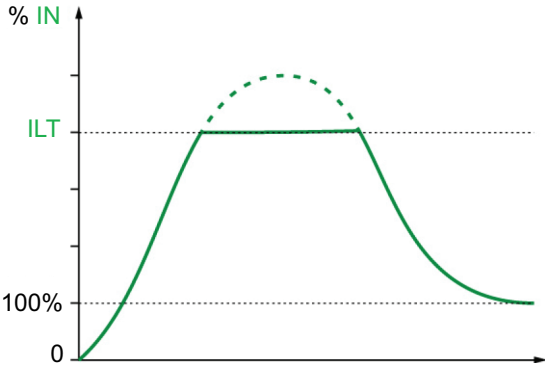
HMI label	Setting	Factory setting
[Current Limit] <i>ILT</i>	150...700%	400% of [Motor Nom Current] <i>IN</i>
<p>Motor limiting current</p> <p>The RMS motor line current will be limited to [Current Limit] <i>ILT</i> multiplied by [Motor Nom Current] <i>IN</i>.</p> <p>[Current Limit] <i>ILT</i> max setting is limited to</p> <ul style="list-style-type: none"> • If in-line connection: $500\% \times I_e / I_N$ • If inside delta connection: $500\% \times I_e / (I_N / \sqrt{3})$ <p>In any case the [Current Limit] <i>ILT</i> max setting will not exceed 700% of nominal motor line current.</p> <p>If [Inside Delta] <i>DLT</i> is set to [Yes] <i>YES</i>, the factory setting is 700% of [Motor Nom Current] <i>IN</i>.</p> <p>The current limit setting is always active during start up and overrides all other settings.</p>  <p>Example 1 in-line connection:</p> <p>ATS480C21Y, with $I_e = 210$ A [Motor Nom Current] <i>IN</i> = 195 A [Current Limit] <i>ILT</i> = 500% (under max setting : $500\% \times I_e / I_N = 5 \times 210 / 195 = 538\%$) Current limitation = $500\% \times 195 = 975$ A</p> <p>Example 2 inside delta connection:</p> <p>ATS480C21Y, with $I_e = 210$ A [Motor Nom Current] <i>IN</i> = 338 A [Current Limit] <i>ILT</i> = 500% (under max setting : $500\% \times I_e / (I_N / \sqrt{3}) = 5 \times 210 / (338 / \sqrt{3}) = 538\%$) Current limitation = $500\% \times 338 = 1690$ A</p>		

Set The Mains Voltage

[Mains Voltage] ULN is used to:

- Optimize the start and stop.
- Estimate the motor power.

The estimated motor power can be consulted with in [Display] MON → [Motor parameters] MMO.

Step	Action
1	Set the mains supply of the soft starter with [Mains Voltage] ULN.

HMI navigation and parameters explanation

Description	Setting range	Factory setting
[Mains Voltage] ULN	170...750 V	400 V
Access path: [Simply Start] SYS → [Simply start] SIM Access path: [Complete settings] CST → [Motor parameters] MPA Mains voltage of the soft starter. If [Inside Delta] DLT is set to [Yes] YES, the setting range is 170...500 V.		

Set Start Profile

The following parameters can be used to control the start of the motor by defining the ramp-up time and the initial torque applied.

[Acceleration] ACC control the ramp-up time from the Run order to established regime.

[Init Starting Torque] TQ0 set the initial starting torque.

By default, **[Control Mode]** is set to **[Torque Control]**, it is also possible to set in to **[Voltage Control]**. For more information, refer to Voltage Boost, page 129.

Step	Action
1	Adjust the ramp time of the soft starter torque between 0 and the nominal torque Tn with [Acceleration] ACC .
2	Set the initial torque during the starting phase with the [Init Starting Torque] TQ0 parameter.

HMI navigation and parameters explanation

Access path: **[Simply Start] SYS** → **[Simply start] SIM**

Access path: **[Complete settings] CST** → **[Start & Stop] SSP**

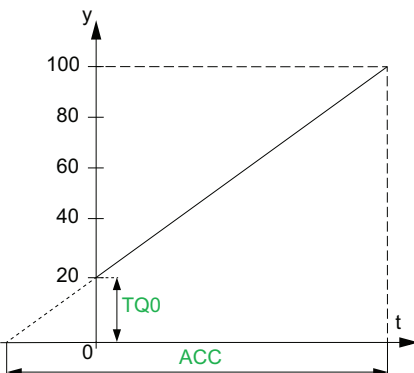
Description	Setting range	Factory setting
[Acceleration] ACC	1...60 s	15 s
<p>Acceleration ramp time</p> <p>This parameter sets the ramp time from no torque to nominal torque.</p> <p>When the motor reaches established regime, the soft starter state change to [Running] RUN or [Bypassed] BYP, even if the motor reaches established regime before the value set to [Acceleration] ACC.</p> <p>The initial starting torque depends on the parameter [Init Starting Torque] TQ0.</p>  <ul style="list-style-type: none"> y: Reference torque as % of nominal torque t: Time (s) 		
[Init Starting Torque] TQ0	0...100% of nominal torque	20%
<p>Initial starting torque</p> <p>Initial torque setting during the starting phase, varies from 0 to 100% of the nominal torque. If set too low, the motor may not start as soon as the RUN command is applied.</p>		

Set Stop Profile

The following parameters can be used to control the stop of the motor.

There are three types of stop:

- Freewheel: No torque is applied to the motor by the soft starter. The motor stops in freewheel.
- Deceleration: The soft starter applies a decreasing torque / voltage to the motor to progressively decelerate it. The decreasing torque follows a defined ramp. This type of stop reduces the risk of water hammering with a pump and has no effect on high inertia applications.
- Braking: The soft starter applies a braking torque to the motor with current injections, slowing it down even if there is considerable inertia.

Step	Action								
1	Set the parameter [Type of stop] STT to define the type of stop: <ul style="list-style-type: none"> • For freewheel, select [Freewheel] F • For deceleration, select [Deceleration] DEC • For braking, select [Braking] B 								
2	<table border="1"> <thead> <tr> <th>If</th> <th>Then</th> </tr> </thead> <tbody> <tr> <td>[Type of stop] STT is set to [Freewheel] F</td> <td>End of the procedure.</td> </tr> <tr> <td>[Type of stop] STT is set to [Deceleration] DEC</td> <td> Set the controlled deceleration time [Deceleration] DEC parameter. Set the freewheel time at the end of the deceleration using [End Of Deceleration] EDC. </td> </tr> <tr> <td>[Type of stop] STT is set to [Braking] B</td> <td> Set the braking gain with the [Braking Level] BRC parameter. Set the end of deceleration by injection with the [DC Braking Time] EBA parameter. </td> </tr> </tbody> </table> <p>The set type of stop will be active at the next Stop order.</p>	If	Then	[Type of stop] STT is set to [Freewheel] F	End of the procedure.	[Type of stop] STT is set to [Deceleration] DEC	Set the controlled deceleration time [Deceleration] DEC parameter. Set the freewheel time at the end of the deceleration using [End Of Deceleration] EDC .	[Type of stop] STT is set to [Braking] B	Set the braking gain with the [Braking Level] BRC parameter. Set the end of deceleration by injection with the [DC Braking Time] EBA parameter.
If	Then								
[Type of stop] STT is set to [Freewheel] F	End of the procedure.								
[Type of stop] STT is set to [Deceleration] DEC	Set the controlled deceleration time [Deceleration] DEC parameter. Set the freewheel time at the end of the deceleration using [End Of Deceleration] EDC .								
[Type of stop] STT is set to [Braking] B	Set the braking gain with the [Braking Level] BRC parameter. Set the end of deceleration by injection with the [DC Braking Time] EBA parameter.								

NOTE:

- **[Braking] B** cannot be used in series with the motor winding in delta. If **[Inside Delta] DLT** is set to **[Yes] YES** when the braking is set, **[Type of stop] STT** will be set to **[Freewheel] F**.
- Only one type of stop can be active at any given time.

HMI navigation and parameters explanation

Access path: **[Simply Start] SYS** → **[Simply start] SIM**

Access path: **[Complete settings] CST** → **[Start & Stop] SSP**

Description	Setting range	Factory setting
[Type of stop] STT	–	[Freewheel] F
Type of stop <ul style="list-style-type: none"> • [Freewheel] F: Freewheel stop. • [Deceleration] DEC: Soft stopping by control of torque. • [Braking] B: Dynamic braking stop. 		

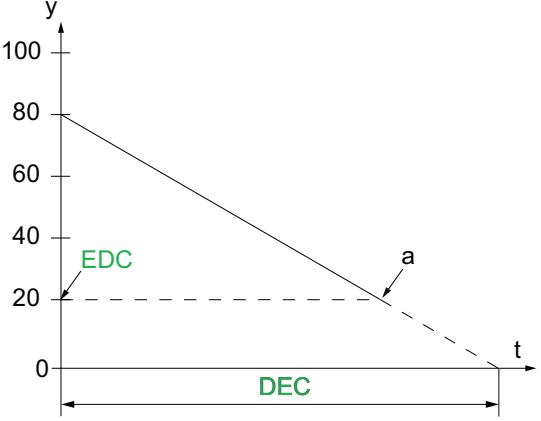
Description	Setting range	Factory setting
[Deceleration] DEC	1...60 s	15 s
<p>Deceleration ramp time</p> <p>This parameter sets the deceleration ramp from the estimated applied torque at Stop order to no torque applied.</p> <p>Example with 80% of the nominal torque when a Stop order is applied:</p>  <ul style="list-style-type: none"> • y: Estimated torque (as a percentage of the nominal torque). • a: End of controlled deceleration set by [End Of Deceleration] EDC, motor stops in freewheel • t: Time (s) <p>Depending on the load characteristics, it is possible the motor may not stop to a standstill at the end of the ramp.</p>		
[End Of Deceleration] EDC	0...100% of estimated torque when a Stop order is applied	20%
<p>End of controled deceleration threshold</p> <p>As soon as the estimated applied torque is below the value set in [End Of Deceleration] EDC (point "a" in the figure above), the motor stops in freewheel.</p> <p>This parameter can be accessed only if [Type of stop] STT is set to [Deceleration] DEC.</p>		

Description	Setting range	Factory setting
[Braking Level] <i>BRC</i>	0...100%	50%

Dynamic braking level

This parameter can only be accessed if [Type of stop] *STT* is set to [Braking] *B*.

Braking is active according to the value set by [Braking Level] *BRC*.

The total stopping time of the motor is configured by adjusting the injection time of the pseudo-direct current in the motor applied on two phases. See next parameter [DC Braking Time] *EBA*.

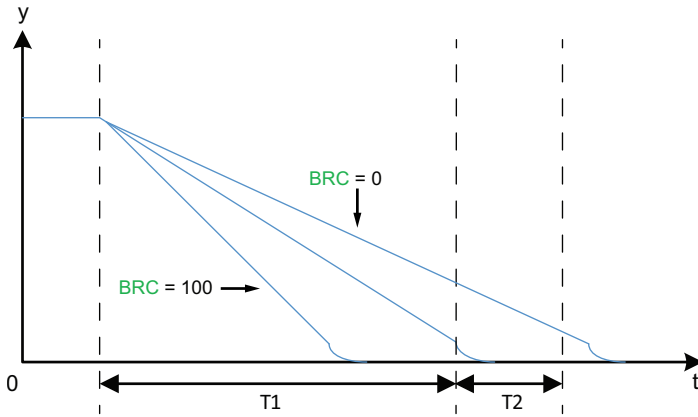

y: Nominal speed.

t: Time (s).

T1: Dynamic braking time, ramp set by [Braking Level] *BRC*.

T2: Adjustment of motor stop by [DC Braking Time] *EBA*.

Pseudo-continuous injection time: $T2 = T1 \times [\text{DC Braking Time}] \text{ EBA}$.

Note: Time T1 is dependant of [Braking Level] *BRC*. The higher the value, the stronger is the braking and the faster is the ramp.

This parameter can only be accessed if [Type of stop] *STT* is set to [Braking] *B*.

NOTICE

MECHANICAL STRESS

- Do not set a high value of [Braking Level] *BRC* if your application have a high inertia.
- Verify that this value is suitable by performing a commissioning test under maximum load conditions.

Failure to follow these instructions can result in equipment damage.

[DC Braking Time] <i>EBA</i>	20...100%	20%
------------------------------	-----------	-----

DC continuous braking time

This parameter adjusts the current injection time at the end of braking.

Example:

Dynamic braking = 10 s (T1)

[DC Braking Time] *EBA* = 20% corresponds to an injection time of 2 s

[DC Braking Time] *EBA* = 100% corresponds to an injection time of 10 s

This parameter can only be accessed if [Type of stop] *STT* is set to [Braking] *B*.

Example Of Typical Configurations For Common Applications

Application	[Current Limit] ILT (% of [Motor Nom Current] IN)	[Acceleration] ACC (s)	[Init Starting Torque] TQ0 (% of nominal torque)	[Type of stop] STT
Centrifugal pump	300	5 to 15	0	[Deceleration] D
Submerged pump	300	Up to 2	20	[Deceleration] D
Piston pump	350	5 to 10	30	[Deceleration] D
Fan	300	10 to 40	0	[Freewheel] F or [Braking] B
Cold compressor	300	5 to 10	30	[Deceleration] D
Screw compressor	300	3 to 20	30	[Deceleration] D
Centrifugal compressor	350	10 to 40	0	[Freewheel] F
Piston compressor	350	5 to 10	30	[Deceleration] D
Conveyor, transporter	300	3 to 10	30	[Deceleration] D
Lifting screw	300	3 to 10	30	[Deceleration] D
Drag lift	400	2 to 10	0	[Deceleration] D
Elevator without passengers	350	5 to 10	20	[Deceleration] D
Circular saw, band saw	300	10 to 60	0	[Braking] B
Pulper, butchery knife	400	3 to 10	20	[Freewheel] F
Agitator	350	5 to 20	10	[Deceleration] D
Mixer	350	5 to 10	50	[Deceleration] D
Grinder	450	5 to 60	0	[Braking] B
Crusher	400	10 to 40	50	[Freewheel] F
Refiner	300	5 to 30	40	[Deceleration] D
Press	400	20 to 60	20	[Deceleration] D

Small Motor Test

This function can be used to validate the wiring of the soft starter by rotating a small motor that is a fraction of the soft starter rating.

The following table gives the minimum motor power required for the small motor function depending on the ATS480 reference. The good functioning of the small motor function is not guaranteed if those minimum ratings are not followed :

Mains supply (Vac)	Minimum motor power for ATS480D17...C11Y	Minimum motor power for ATS480C14...M12Y
200	3kW	7,5kW
230	4kW	7,5kW
380	5,5kW	15kW
400	7,5kW	15kW
440	7,5kW	15kW
500	7,5kW	15kW
600	9kW	18,5kW
690	11kW	22kW

Step	Action
1	Wire a small motor, refer to the ratings table above.
2	Set [Small Motor Test] <i>SST</i> to [Yes] <i>YES</i> .
3	To start the test, apply a Run command to the soft starter by pressing the RUN button on the display terminal or via the STOP and RUN control terminals.
4	To stop the test, apply a Stop command to the soft starter by pressing the STOP / RESET button on the display terminal or via the STOP and RUN control terminals.

If **[Small Motor Test]** *SST* function is active:

- **[Phase Loss Monit]** *PHP* is set to **[No]** *NO*, phase loss monitoring is disabled.
- **[Control Mode]** *CLP* parameter is forced to **[Voltage Control]** *VC*.

⚠ WARNING
TEMPORARY MODIFICATION OF THE BEHAVIOR
<ul style="list-style-type: none"> • Only use this function for test and maintenance purposes. • Verify that disabling phase loss detection does not result in unsafe conditions. <p>Failure to follow these instructions can result in death, serious injury, or equipment damage.</p>

NOTE: The **[Small Motor Test]** *SST* test function is set to **[No]** *NO* when the soft starter control supply is disconnected. Upon next power-up the soft starter, including **[Phase Loss Monit]** *PHP* and **[Control Mode]** *CLP*, will return to its previous configuration.

Description	Setting range	Factory setting
[Small Motor Test] SST	–	[No] NO
<p>Small motor test</p> <p>Access path: [Complete settings] CST → [Motor wiring] MWMT</p> <ul style="list-style-type: none"> • [Yes] YES: Ready to start the test, apply a Run command • [No] NO: Function inactive, will normally start when a Run command is applied <p>During the test, the display terminal displays the state [Small Motor Test] SST.</p> <p>When [Small Motor Test] SST is set to [Yes] YES:</p> <ul style="list-style-type: none"> • [Phase Loss Monit] PHP is set to [No] NO, phase loss monitoring is disabled. • [Control Mode] CLP parameter is forced to [Voltage Control] VC. 		

Connection Inside The Delta Of The Motor

This function enables the soft starter connection in the motor delta winding. For the diagrams to wire the soft starter inside the delta of the motor, refer to Connection Of The Motor and Supply Mains, page 50 and Application Diagrams, page 61.

Step	Action
1	Set [Inside Delta] DLT to [Yes] YES . The soft starter can now operate inside the motor delta windings.
2	Setting [Inside Delta] DLT to [Yes] YES can modify the setting of the parameters in the menu [Simply Start] SYS → [Simply start] SIM . Verify that the parameter settings in this menu are adequate with the use of the soft starter inside the motor delta windings.
3	After validating the settings in the menu [Simply Start] SYS → [Simply start] SIM , send a Run order to start the motor.
4	To stop the motor, send a Stop order. The motor will stop following the setting of [Type of stop] STT .

NOTE:

- An integrated diagnostic is available to verify the correct wiring of the soft starter in the motor delta winding. For more information about how to use this diagnostic, refer to Diagnostic Of The Delta Connection, page 120.
- If a bypass contactor is used, **[Phase Loss] PHF3** error detection can take more time.

The following functions are not compatible with connections inside the delta of the motor:

- If **[Inside Delta] DLT** is set to **[Yes] YES** while **[Type of stop] STT** was set to **[Braking] B**, **[Type of stop] STT** will be forced to **[Freewheel] F** and will not change back if **[Inside Delta] DLT** is set back to **[No] NO**
- If **[Preheating Assign] PRHA** or **[Cascade] CSC** is assigned, **[Inside Delta] DLT** will be forced to **[No] NO**.

For the complete list of incompatibilities, refer to Functions Compatibility Table, page 246.

HMI label	Setting	Factory setting
[Inside Delta] DLT	[No] NO or [Yes] YES	[No] NO
Starter with delta winding in series connection		
Access path: [Complete settings] CST → [Motor wiring] MWMT		
NOTICE		
DESTRUCTION OF THYRISTOR		
Only set the parameter [Inside Delta] DLT to [Yes] YES if the mains voltage does not exceed 500 Vac.		
Failure to follow these instructions can result in equipment damage.		
<ul style="list-style-type: none"> • [No] NO: soft starter connected “in-line” mode • [Yes] YES: soft starter connected “delta-inside” mode 		
The parameter [Inside Delta] DLT must be set to [Yes] YES before the settings of the parameters available in the menu [Simply Start] SYS → [Simply start] SIM , otherwise they could be modified and set back to their default values.		
[Type of stop] STT is automatically set to [Freewheel] F if [Inside Delta] DLT is set to [ON] ON while [Type of stop] STT was set to [Braking] B .		

Diagnostic Of The Delta Connection

This function offers a diagnostic procedure to verify the correct wiring of the soft starter in the motor delta winding.

This procedure must be applied without a load.

The corrections proposed by the diagnostic does not ensure that the motor will start in the correct direction.

For the diagrams to wire the soft starter inside the delta of the motor, refer to Connection Of The Motor and Supply Mains, page 50 and Application diagrams, page 66.

This function requires **[Inside Delta] DLT** to be set to **[Yes] YES**.

DANGER

HAZARD OF ELECTRIC SHOCK, EXPLOSION, OR ARC FLASH

Before any modification of the wiring on the equipment:

- Use all required personal protective equipment (PPE).
- Disconnect all power, including external control power that may be present. Take into account that the circuit breaker or main switch does not de-energize all circuits.
- Verify the absence of voltage using a properly rated voltage sensing device.

Failure to follow these instructions will result in death or serious injury.

Step	Action
1	Set [In Delta Diag] DLTL to [Yes] YES . Result: It starts the delta inside wiring diagnostic, mains supply must be present and no current is injected into the motor.
2	Refer to the [In Delta Diag Status] DLTS table below to perform the required actions. The corrections listed by [In Delta Diag Status] DLTS does not ensure that the motor will start in the correct direction.
3	When the diagnostic is done, [In Delta Diag] DLTL is forced back to [No] NO . To start a new diagnostic after performing an action on the delta wiring, set [In Delta Diag] DLTL back to [Yes] YES .
4	When [In Delta Diag Status] DLTS displays the status [Passed] OK , check the rotation direction of the motor by applying a Run order to start the motor without load. If the rotation direction is not correct, invert 2 phases on the output of the soft starter.
5	When the rotation direction has been checked, the motor can be start and stop with its load.

NOTE: If a bypass contactor is used, **[Phase Loss] PHF3** error detection can take more time.

Diagnostic result:

[In Delta Diag Status] DLTS	Definition
[Not Done] NA	Diagnostic not done.
[Passed] OK	Diagnostic successfully passed, ready to start
[Pending] PEND	Mains supply not detected by the soft starter. Verify the presence of the mains supply on the power parts of the soft starter: 1/L1, 3/L2 and 5/L2.
[Invert L2 & L3] 32	Invert phase 2 and 3
[Invert L1 & L2] 21	Invert phase 1 and 2
[Invert L1 & L3] 31	Invert phase 1 and 3
[Change 123 to 312] 312	Do a circular permutation, phase 1 on 2, phase 2 on 3, phase 3 on 1.
[Change 123 to 231] 231	Do a circular permutation, phase 1 on 3, phase 3 on 2, phase 2 on 1.
[Bad Motor Wiring] MOT	Check motor coupling and windings.
[Unknown Error] UNK	Unknown error (missing wire, 2 phases on the same motor phase, motor in line)

The corrections listed by [In Delta Diag Status] **DLTS** must be applied between the motor terminals (point “c” on the diagram below) and the supply mains upstream the soft starter (point “a”).

Example: [In Delta Diag Status] **DLTS = [Invert L2 & L3] **32**:**

Before correction:

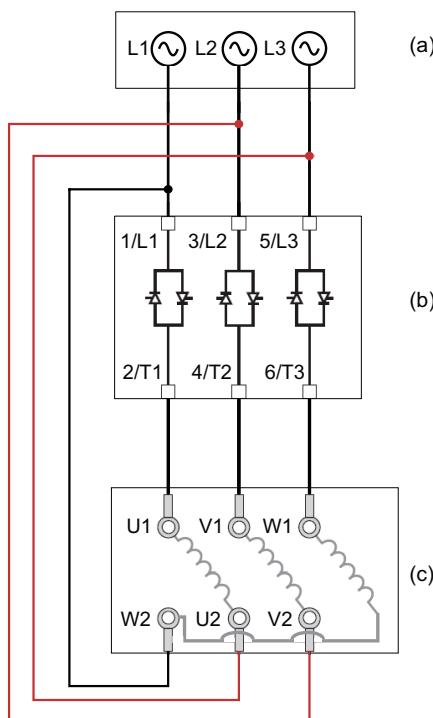

After correction:

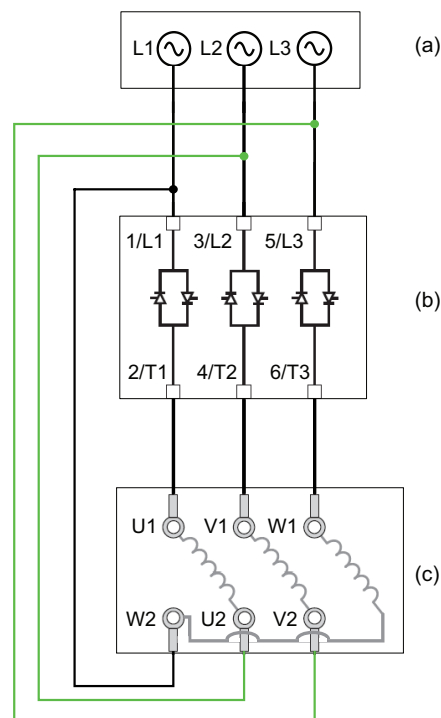

- (a): Supply mains
- (b): Soft starter
- (c): Motor terminals

HMI label	Setting	Factory setting
[In Delta Diag] DLTL	–	[No] NO
<p>Inside Delta diagnostics</p> <p>Access path: [Complete settings] CST → [Motor wiring] MWMT</p> <ul style="list-style-type: none"> • [No] NO: no delta inside diagnostic • [Yes] YES: start delta inside wiring diagnostic <p>[In Delta Diag] DLTL is forced back to [No] NO after a diagnostic. To start another diagnostic set it back to [Yes] YES.</p> <p>This parameter is visible if [Inside Delta] DLT is set to [Yes] YES.</p>		
[In Delta Diag Status] DLTS	–	[Not Done] NA
<p>Inside Delta diagnostics status</p> <p>Access path: [Complete settings] CST → [Motor wiring] MWMT</p> <p>This parameter gives the status of the inside delta wiring diagnostic [In Delta Diag] DLTL. In case of bad wiring, the corrections must be applied between the induction motor (point “c” on the diagram above) and the supply mains upstream the soft starter (point “a”).</p> <ul style="list-style-type: none"> • [Not Done] NA: diagnostic not done. • [Passed] OK: diagnostic successfully passed • [Pending] PEND: Mains supply not detected by the soft starter. Verify the presence of the mains supply on the power parts of the soft starter: 1/L1, 3/L2 and 5/L2. • [Invert L2 & L3] 32: inverse phase 2 and 3 • [Invert L1 & L2] 21: inverse phase 1 and 2 • [Invert L1 & L3] 31: : inverse phase 1 and 3 • [Change 123 to 312] 312: circular permutation, phase 1 on 2, phase 2 on 3, phase 3 on 1 • [Change 123 to 231] 231: circular permutation, phase 1 on 3, phase 2 on 1, phase 3 on 2 • [Bad Motor Wiring] MOT: Check motor coupling and windings • [Unknown Error] UNK: unknown error (missing wire, 2 phases on the same motor phase, motor in line) <p>The listed corrections does not ensure that the motor will start in the correct direction.</p> <p>This parameter is visible if [Inside Delta] DLT is set to [Yes] YES.</p>		

Motor Preheating

By applying a current inside the motor windings, the preheating function can be used before starting the motor to:

- Unfreeze the motor.
- Help to prevent temperature deviations and condensation.
- Start the motor at the same temperature to limit the variations between cold and warm state.

The motor does not turn during preheating.

During preheating, the motor thermal monitoring function is not active.

NOTICE
<p>MOTOR OVERHEATING</p> <ul style="list-style-type: none"> • Verify that the connected motor is properly rated for the current to be applied in terms of amount and time. • Add an external thermal sensor to monitor the temperature of the motor if preheating operation can result in motor windings overheating. <p>Failure to follow these instructions can result in equipment damage.</p>

To monitor the motor temperature, use an external thermal sensor:

- Wire it to the soft starter PTC terminal and set the thermal monitoring, refer to 2.11 [Thermal monitoring] TPP, page 153.
- Set relay R3 to [Motor Overload Warn] OLMA.

The preheating function is not compatible with:

- The cascade function.
- Starting inside the motor delta.
- 2-wire control, refer to RUN and STOP Management, page 56 for more information.

For the complete list of incompatibilities, refer to Functions Compatibility Table, page 246.

Step	Action
1	Set [Preheating Assign] PRHA to DI3, DI4 or a virtual input via the CMD word, bits 11 to 15. Refer to the fieldbus manuals for the CMD word assignments.
2	Set the heating current level [Preheat Level] IPR.
3	Set the time delay before the preheating start [Time Before Preheat] TPR. The [Time Before Preheat] TPR counting start when the motor is stopped. The motor will not preheat as long [Time Before Preheat] TPR and [Time Before Restart] TBS are not elapsed.

Step	Action
4	<p>To start the preheating:</p> <ul style="list-style-type: none"> The motor must be stopped [Time Before Restart] TBS must be elapsed [Time Before Preheat] TPR is elapsed Apply and maintain a high level on the STOP terminal Apply and maintain a high level on the digital input set to [Preheating Assign] PRHA in step 1 <p>The status [Motor Preheating] HEA is displayed on the display terminal.</p>
5	<p>To stop the preheating:</p> <ul style="list-style-type: none"> Apply and maintain a low level on the digital or virtual input set to [Preheating Assign] PRHA Or apply a Run order Or apply a Stop order

[Time Before Preheat] TPR and **[Time Before Restart]** TBS are not cumulative.

State diagram of the preheating function:

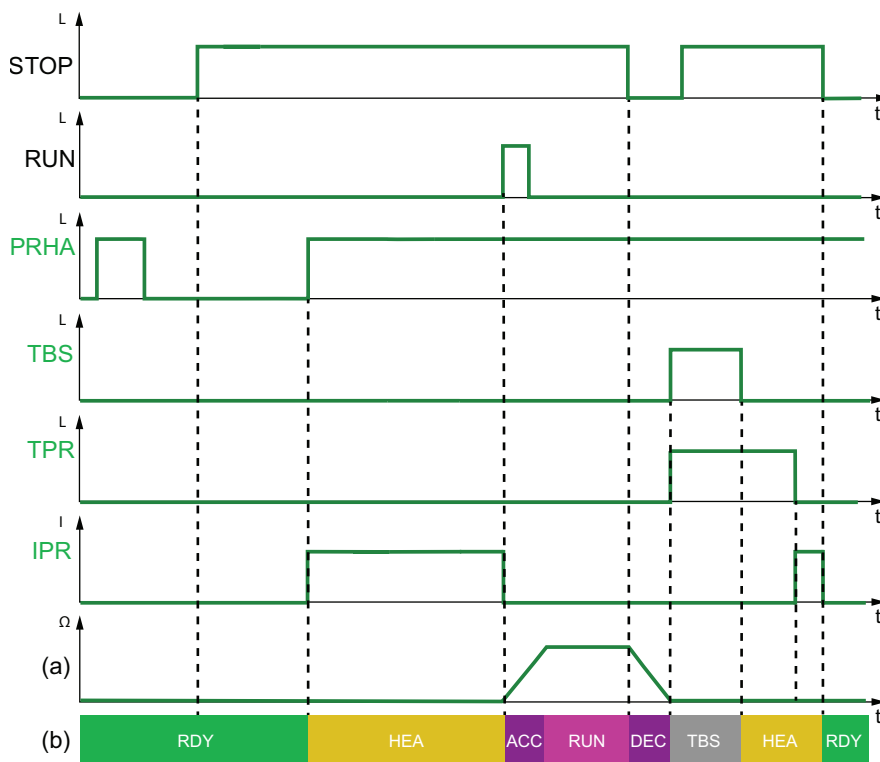

- PRHA: Level applied to the digital inputs assigned to **[Preheating Assign]** PRHA
- TBS: **[Time Before Restart]** TBS
- TPR: **[Time Before Preheat]** TPR
- IPR: Preheat current injected in the motor
- (a): Motor rotation speed
- (b): Soft starter state. For the list of possible state of the soft starter, refer to Soft Starter State, page 99.

Access path: **[Complete settings]** CST → **[Preheating]** PRF

Description	Setting range	Factory setting
[Preheating Assign] PRHA	-	[Not Assigned] NO

Preheating assignment

Assign a digital or virtual input to start the preheating.

- **[Not Assigned]** NO: preheating start not assigned
- **[DI3]** LI3: preheating start assigned to digital input DI3
- **[DI4]** LI4: preheating start assigned to digital input DI4

It is possible to assign this parameter on a virtual input via the CMD word, bits 11 to 15. Refer to the fieldbus manuals for the CMD word assignments.

NOTE: When using the **[CD••]** / **[C•••]** activation and a communication channel as the active channel, the *Halt* command must be active to remain in the 5 - *Operation enabled* state. For further information, please refer to the associated communication manuals.

To start the preheating:

- The motor must be stopped
- **[Time Before Restart]** TBS must be elapsed
- **[Time Before Preheat]** TPR is elapsed
- Apply and maintain a high level on the STOP terminal
- Apply and maintain a high level on the digital input set to **[Preheating Assign]** PRHA in step 1

The status **[Motor Preheating]** HEA is displayed on the display terminal.

To stop the preheating:

- Apply and maintain a low level on the digital or virtual input set to **[Preheating Assign]** PRHA
- Or apply a Run order
- Or apply a Stop order



DANGER

ELECTRIC SHOCK AND/OR UNANTICIPATED EQUIPMENT OPERATION

- Verify that the setting of the parameter **[Time Before Preheat]** does not result in unsafe conditions.
- When preheating function is used, always consider that the equipment is in the operating state Operation Enabled.

Failure to follow these instructions will result in death or serious injury.

Description	Setting range	Factory setting
[Preheat Level] IPR	0...100%	0%
<p>Preheating level</p> <p>This parameter sets the heating current level. Use a properly rated ammeter to adjust the preheating current level.</p> <ul style="list-style-type: none"> • 0%: Apply the minimum current created by the minimum firing angle. Use a properly rated ammeter to adjust the preheating current level. • 100%: Apply the maximum current created by the minimum firing angle. Use a properly rated ammeter to adjust the preheating current level. <p>Remark: At 0% a preheating current is still applied to the motor. During preheating, the motor thermal monitoring function is not active.</p> <div style="border: 1px solid black; padding: 5px; text-align: center; margin: 10px 0;">NOTICE</div> <p>MOTOR OVERHEATING</p> <ul style="list-style-type: none"> • Verify that the connected motor is properly rated for the current to be applied in terms of amount and time. • Add an external thermal sensor to monitor the temperature of the motor if preheating operation can result in motor windings overheating. <p>Failure to follow these instructions can result in equipment damage.</p> <p>If the frequency of the mains is not stable, the preheating current level may be increased compared to the set value and lead to motor overheating.</p> <div style="border: 1px solid black; padding: 5px; text-align: center; margin: 10px 0;">NOTICE</div> <p>MOTOR OVERHEATING</p> <p>If the frequency of the mains is not stable:</p> <ul style="list-style-type: none"> • Add an external thermal sensor to monitor the temperature of the motor. <p>or</p> <ul style="list-style-type: none"> • Add an external device to monitor the frequency and switch off the preheating function in case of fluctuations. <p>Failure to follow these instructions can result in equipment damage.</p> <p>This parameter is visible only if [Preheating Assign] PRHA is set to [DI3] LI3 , [DI4] LI4 or a virtual digital input.</p> <p>[Preheat Level] IPR is independent from [Motor Nom Current] IN.</p>		

Description	Setting range	Factory setting
[Time Before Preheat] TPR	0...999 min	5 min
<p><i>Time before preheat</i></p> <p>The time delay set to this parameter starts as soon as a Stop order is applied.</p> <ul style="list-style-type: none"> 0...999 min: Set the time delay before preheating starts. <p>The soft starter will not preheat the motor as long as [Time Before Preheat] TPR is not elapsed</p> <p>The status [Motor Preheating] HEA is displayed on the display terminal when the preheating order is applied, even if no current is injected in the motor windings.</p> <div style="background-color: black; color: white; text-align: center; padding: 5px;">  DANGER </div> <p>ELECTRIC SHOCK AND/OR UNANTICIPATED EQUIPMENT OPERATION</p> <ul style="list-style-type: none"> Verify that the setting of the parameter [Time Before Preheat] does not result in unsafe conditions. When preheating function is used, always consider that the equipment is in the operating state Operation Enabled. <p>Failure to follow these instructions will result in death or serious injury.</p> <p>This parameter is visible only if [Preheating Assign] PRHA is set to [DI3] LI3, [DI4] LI4 or a virtual digital input.</p>		

Torque / Voltage Control

The start and controlled stop profiles follow a motor control algorithm, active either on a torque profile or on a voltage profile. This function can be used to choose torque or voltage profile to control the motor start and stop.

Torque control is specified for pumps, fans with belts, circular saws and limits:

- Jerk when the motor starts
- Hammering effect
- Sliding effect

Voltage control is specified for motors in parallel on one soft starter.

With torque control, the start and stop of the motor can be set via the **[Simply Start] SYS** menu, for more information refer to **[Simply Start] SYS**, page 108.

With voltage control, the start and stop of the motor can be set via the **[Simply Start] SYS** menu and the parameter **[Init Starting Voltage] V0** must be considered, for more information refer to Voltage Boost, page 129.

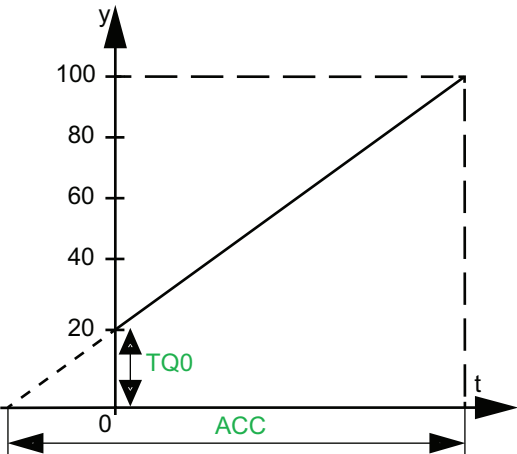
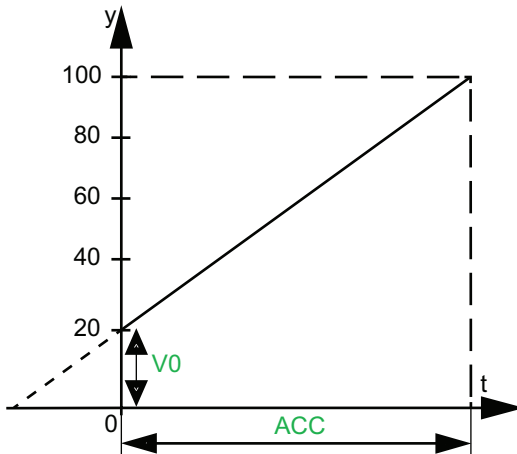
Description	Setting range	Factory setting
[Control Mode] CLP	[Torque Control] TC or [Voltage Control] VC	[Torque Control] TC
<p>Control mode</p> <p>Access path: [Complete settings] CST → [Start & Stop] SSP</p> <ul style="list-style-type: none"> • [Torque Control] TC: Activate torque control. • [Voltage Control] VC: Activate voltage control 		
<p>Acceleration with torque control:</p>  <ul style="list-style-type: none"> • y: Reference torque as % of nominal torque • t: Time (s) • TQ0: Initial starting torque • ACC: Acceleration ramp time <p>More information about Initial starting torque and Acceleration ramp time in Set Start Profile, page 112.</p>		<p>Acceleration with voltage control:</p>  <ul style="list-style-type: none"> • y: Reference voltage as % of nominal voltage • t: Time (s) • V0: Initial starting voltage • ACC: Acceleration ramp time

Voltage Boost

This function can be used to provide a boost at the start to overcome a mechanical hard point.

As an application example, a chocolate crusher. The grinding of the chocolate is done when it's hot. Once the motor is stopped, the chocolate cools down, glueing the roller flatteners. In order to overcome the resistant torque due to the rollers being stuck by the chocolate and the elasticity of the material, it is necessary to apply a higher initial torque.

The voltage boost can be used in torque control and voltage control.

The voltage boost function apply a level of the nominal voltage **[Mains Voltage] ULN** between 50% and 100% for 100 ms.

[Init Starting Voltage] V0 is inhibited when **[Boost] BST** is active

Boost with torque control:

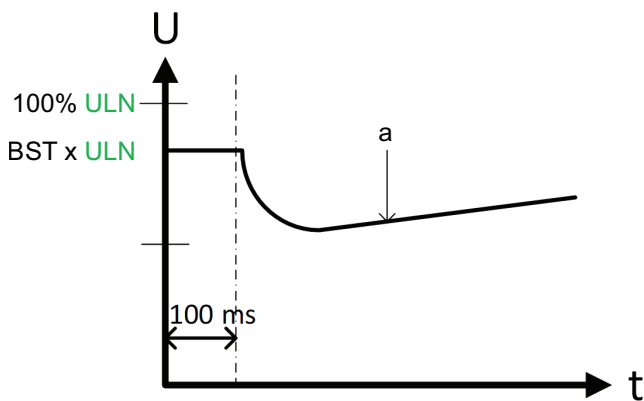

a: Voltage generated by the torque control

Boost with voltage control:

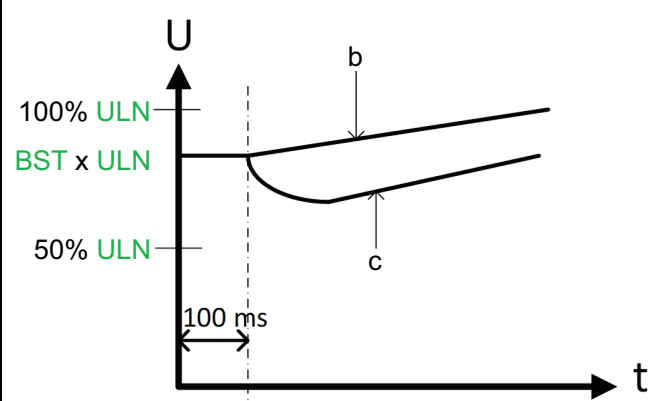

b: Voltage ramp initialized to **[Boost] BST** value
c: Voltage ramp in case of current limitation

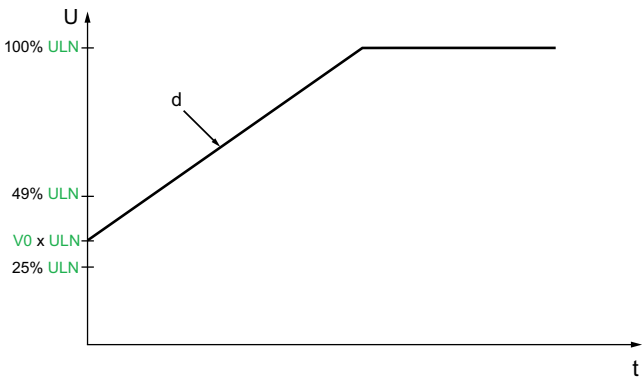
Description	Setting range	Factory setting
[Boost] <i>BST</i>	50%...100% of [Mains Voltage] <i>ULN</i> or [No] <i>NO</i>	[No] <i>NO</i>
<p>Voltage boost level</p> <p>Access path: [Complete settings] <i>CST</i> → [Start & Stop] <i>SSP</i></p> <ul style="list-style-type: none"> [No] <i>NO</i>: Function inactive 50...100%: setting as a % of mains voltage during boost. <p>NOTE: Setting the value of this parameter too high can cause overcurrent and trigger error such as [Overcurrent] <i>OCF</i></p>		
[Init Starting Voltage] <i>V0</i>	25%...49% of [Mains Voltage] <i>ULN</i>	49%
<p>Initial starting voltage</p> <p>Access path: [Complete settings] <i>CST</i> → [Start & Stop] <i>SSP</i></p> <p>Set [Init Starting Voltage] <i>V0</i> level between 25% and 49% of [Mains Voltage] <i>ULN</i>. The set value must be high enough to create a torque superior to the resistive torque.</p>  <p>d: Voltage starting ramp</p> <p>This parameter is visible if:</p> <ul style="list-style-type: none"> [Control Mode] <i>CLP</i> is set to [Voltage Control] <i>VC</i> [Boost] <i>BST</i> is set to [No] <i>NO</i> 		

Second Motor Parameters

About this Menu

Access path: **[2nd Mot Parameters]** ST2

This menu can be used to configure a second set of parameters on the same soft starter.

It can be used to:

- Adapt the soft starter parameters to several loads on a single motor.
- Start and stop a two-speed motor.

The **[Type of stop]** STT set in **[Simply start]** SIM applies to **[2nd Mot Assign]** LIS.

How to set Second Motor Parameters

Step	Action								
1	Assign [2nd Mot Assign] LIS to DI3, DI4 or a virtual input via the CMD word, bits 11 to 15. Refer to the fieldbus manuals for the CMD word assignments.								
2	Set [Nom Current Motor 2] INM2.								
3	Set [Current Limit Motor 2] ILM2.								
4	Set [Acceleration Motor 2] ACM2.								
5	Set [Init Start Torque Mot 2] TQM2.								
6	<p>[Type of stop] STT is applicable to [2nd Mot Parameters] ST2:</p> <table border="1"> <thead> <tr> <th>If</th> <th>Then</th> </tr> </thead> <tbody> <tr> <td>[Type of stop] STT is set to [Freewheel] F</td> <td>Continue to step 7.</td> </tr> <tr> <td>[Type of stop] STT is set to [Deceleration] D</td> <td> 1. Set [Deceleration Motor 2] DEM2. 2. Set [End Of Dec Motor 2] EDM2. 3. In case of instability during deceleration reduce the value set to [Dec Gain Motor 2] TIM2 until the instability is resolved. Access path: [2nd Mot Parameters] ST2 </td> </tr> <tr> <td>[Type of stop] STT is set to [Braking] B</td> <td>Parameters [Braking Level] BRC and [DC Braking Time] EBA parameters automatically applies and cannot be edited for [2nd Mot Parameters] ST2. Continue to step 8.</td> </tr> </tbody> </table>	If	Then	[Type of stop] STT is set to [Freewheel] F	Continue to step 7.	[Type of stop] STT is set to [Deceleration] D	1. Set [Deceleration Motor 2] DEM2. 2. Set [End Of Dec Motor 2] EDM2. 3. In case of instability during deceleration reduce the value set to [Dec Gain Motor 2] TIM2 until the instability is resolved. Access path: [2nd Mot Parameters] ST2	[Type of stop] STT is set to [Braking] B	Parameters [Braking Level] BRC and [DC Braking Time] EBA parameters automatically applies and cannot be edited for [2nd Mot Parameters] ST2. Continue to step 8.
If	Then								
[Type of stop] STT is set to [Freewheel] F	Continue to step 7.								
[Type of stop] STT is set to [Deceleration] D	1. Set [Deceleration Motor 2] DEM2. 2. Set [End Of Dec Motor 2] EDM2. 3. In case of instability during deceleration reduce the value set to [Dec Gain Motor 2] TIM2 until the instability is resolved. Access path: [2nd Mot Parameters] ST2								
[Type of stop] STT is set to [Braking] B	Parameters [Braking Level] BRC and [DC Braking Time] EBA parameters automatically applies and cannot be edited for [2nd Mot Parameters] ST2. Continue to step 8.								
7	If needed, set [Torque Limit Motor 2] TLM2 and [Dec Gain Motor 2] TIM2.								
8	Activate the second set of parameters by applying a high level on the digital input set to [2nd Mot Param Set] LIS.								

Switching to the Second Motor Parameters

When switching to the second motor parameters, the following parameters are taken into account:

In RDY state:		In RUN state:
[Nom Current Motor 2] <i>INM2</i>	[End Of Dec Motor 2] <i>EDM2</i>	[Current Limit Motor 2] <i>ILM2</i>
[Acceleration Motor 2] <i>ACM2</i>	[Current Limit Motor 2] <i>ILM2</i>	[Torque Limit Motor 2] <i>TLM2</i>
[Deceleration Motor 2] <i>DEM2</i>	[Torque Limit Motor 2] <i>TLM2</i>	
[Init Start Torque Mot 2] <i>TQM2</i>	[Dec Gain Motor 2] <i>TIM2</i>	

HMI description

Description	Setting range	Factory setting
[2nd Mot Assign] <i>LIS</i>	–	[Not Assigned] <i>NO</i>
<p>Second motor selection assignment</p> <p>Assign a digital input to start the second set of parameters.</p> <ul style="list-style-type: none"> • [Not Assigned] <i>NO</i>: second set of parameters start not assigned • [DI3] <i>LI3</i>: second set of parameters start assigned to digital input DI3 • [DI4] <i>LI4</i>: second set of parameters start assigned to digital input DI4 • It is possible to assign this parameter on a virtual input via the CMD word, bits 11 to 15. Refer to the fieldbus manuals for the CMD word assignments. <p>At low level of the assigned input/bit, 1st set of motor parameters is used. At high level, 2nd set of motor parameters is used.</p> <p>NOTE: The switch between the 2 sets of motor parameters, must only be done at standstill.</p>		
[Nom Current Motor 2] <i>INM2</i>	0.4...1.3 of soft starter rating	(1)
<p>Motor 2 nominal current</p> <p>Adjust the value of [Nom Current Motor 2] <i>INM2</i> according to the rated motor current indicated on the motor nameplate.</p> <p>For more information about Nominal current, refer to Set The Currents, page 109.</p> <p>The value set to [Nom Current Motor 2] <i>INM2</i> determines the current of the motor thermal monitoring, depending on which motor class is set. For more information regarding the motor thermal monitoring and the selection of the motor class, refer to 2 [Monitoring] <i>PROT</i>, page 143.</p> <p>(1) Factory setting of [Nom Current Motor 2] <i>INM2</i> is corresponding to the usual value of a 4-pole 400 V standardised motor and [Inside Delta] <i>DLT</i> is set to [No] <i>NO</i>.</p> <p>This parameter can be accessed if [2nd Mot Assign] <i>LIS</i> is configured.</p>		
[Current Limit Motor 2] <i>ILM2</i>	150...700%	400% of [Nom Current Motor 2] <i>INM2</i>
<p>Motor 2 current limit</p> <p>This parameter can be accessed if [2nd Mot Assign] <i>LIS</i> is set to digital or a virtual input.</p> <p>For more information about Motor limiting current, refer to Set The Currents, page 109.</p>		
[Acceleration Motor 2] <i>ACM2</i>	1...60 s	15 s
<p>Motor 2 acceleration time</p> <p>For more information about Acceleration ramp time, refer to Set Start Profile, page 112</p>		

Description	Setting range	Factory setting
[Init Start Torque Mot 2] TQM2	0...100% of nominal torque	20%
<p>Motor 2 initial starting torque</p> <p>Initial torque setting during the starting phase. If set too low, the motor may not start as soon as the RUN command is applied.</p> <p>[Init Start Torque Mot 2] cannot be higher than [Torque Limit Motor 2].</p> <p>This parameter can be accessed if:</p> <ul style="list-style-type: none"> • [2nd Mot Assign] is set to digital or a virtual input. • [Control Mode] is set to [Torque Control]. <p>For more information about <i>Initial starting torque</i> refer to Set Start Profile, page 112.</p>		
[Deceleration Motor 2] DEM2	1...60 s	15 s
<p>Motor 2 deceleration time</p> <p>This parameter can be accessed if:</p> <ul style="list-style-type: none"> • [2nd Mot Assign] is set to digital or a virtual input. • [Type of stop] is set to [Deceleration]. <p>For more information about <i>Deceleration ramp time</i>, refer to Set Stop Profile, page 113.</p>		
[End Of Dec Motor 2] EDM2	0...100% of estimated torque when a Stop order is applied	20%
<p>Motor 2 end of controled deceleration threshold</p> <p>As soon as the estimated torque is below the value set in [End Of Dec Motor 2], the motor stops in freewheel.</p> <p>This parameter can be accessed if:</p> <ul style="list-style-type: none"> • [2nd Mot Assign] is set to digital or a virtual input. • [Type of stop] is set to [Deceleration]. • [Control Mode] is set to [Torque Control]. <p>For more information about <i>End of controled deceleration threshold</i> refer to Set Stop Profile, page 113.</p>		
[Torque Limit Motor 2] TLM2	10...200% or [No] NO	[No] NO
<p>Motor 2 torque limit</p> <p>This parameter can be used to:</p> <ul style="list-style-type: none"> • Limit torque reference during deceleration in case of high inertia application. • Provide constant torque during acceleration if [Init Start Torque Mot 2] is equal to [Torque Limit Motor 2] <p>This parameter can be accessed if:</p> <ul style="list-style-type: none"> • [2nd Mot Assign] is set to digital or a virtual input. • [Control Mode] is set to [Torque Control]. <p>For more information about <i>Torque limit</i> refer to Set Stop Profile, page 113.</p>		
[Dec Gain Motor 2] TIM2	10...50 %	40 %
<p>Motor 2 torque control deceleration gain</p> <p>This parameter reduces instability during deceleration.</p> <p>This parameter can be accessed if:</p> <ul style="list-style-type: none"> • [2nd Mot Param Set] is set to digital or a virtual input. • [Type of stop] is set to [Deceleration]. • [Control Mode] is set to [Torque Control] <p>For more information about <i>Torque control deceleration gain</i>, refer to Set Stop Profile, page 113.</p>		

Cascade Motors

This function can be used to start and stop several motors in sequence with the same soft starter.

For the cascade motors diagrams refer to the application note NNZ85564 (English).

It is mandatory to have motors compatible with the rated current of the soft starter.

Example: An ATS480D17Y can start motors with rated current comprised between 6 and 22 A.

NOTE:

- Only the motor which is active through the sequence can be controlled and monitored.
- When **[Cascade Activation] CSC** is set to **[Yes] YES**, **[Motor Class] THP** is automatically set to **[No Protection] NO**
- To be usable **[Cascade Activation] CSC** requires:
 - **[Inside Delta] DLT** set to **[No] NO**.
 - **[R1 Assignment] R1** set to **[Isolating Relay] ISOL**
 - No digital input set to **[Preheating Assign] PRHA**
 - No digital input set to **[Freewheel Assign] FFSA**
 - Set **[Cmd channel 1] CD1** to **[Terminal] TER** and **[Command Switching] CCS** to **[Cmd channel 1] CD1**
 - Set **[HMI L/R cmd] BMP** to **[Disabled] DIS** and **[Forced Local Chan] FLOC** to **[Terminal] TER**.

For more information about how to operate the cascade function sequence refer to the related application note in NNZ85564 (English).

 **DANGER**

HAZARD OF ELECTRIC SHOCK, EXPLOSION OR ARC FLASH

If cascade function is enabled, monitoring functions such as output phase loss detection are not effective for the motors that are started and bypassed. Phase loss and, by implication, accidental disconnection of cables, are not detected.

- Verify that the absence of phase loss monitoring does not result in unsafe conditions or install external monitoring device to detect phase loss on each motor.

Failure to follow these instructions will result in death or serious injury.

Step	Action
1	Assign relay R1 to [Isolating Relay] ISOL .
2	Verify: <ul style="list-style-type: none"> • [Freewheel Assign] FFSA is set to [Not Assigned] NO • [Preheating Assign] PRHA set to [Not Assigned] NO • [Inside Delta] DLT set to [No] NO • [Cmd channel 1] CD1 is set to [Terminal] TER and [Command Switching] CCS to [Cmd channel 1] CD1 • [HMI L/R cmd] BMP is set to [Disabled] DIS and [Forced Local Chan] FLOC to [Terminal] TER
3	Set [Cascade Activation] CSC parameter to [Yes] YES .
4	Assign [Cascade DI Assign] CSCA to DI3 or DI4.

HMI label	Setting	Factory setting
[Cascade Activation] CSC	[Yes] YES or [No] NO	[No] NO
<p>Cascade function activation</p> <p>Access path: [Complete settings] CST → [Cascade] CSC</p> <ul style="list-style-type: none"> [Yes] YES: activate cascade function [No] NO: deactivate cascade function <p>This parameter requires:</p> <ul style="list-style-type: none"> [Inside Delta] DLT is set to [No] NO No digital input set to [Preheating Assign] PRHA No digital input set to [Freewheel Assign] FFSA [R1 Assignment] R1 set to [Isolating Relay] ISOL [Cmd channel 1] CD1 is set to [Terminal] TER and [Command Switching] CCS set to [Cmd channel 1] CD1 [HMI L/R cmd] BMP set to [Disabled] DIS and [Forced Local Chan] FLOC set to [Terminal] TER. <p>When the cascade function is enabled, thermal monitoring of the motor is disabled.</p>		
NOTICE		
<p>MOTOR OVERHEATING</p> <ul style="list-style-type: none"> Install external thermal monitoring equipment for each motor used in the cascade sequence. <p>Failure to follow these instructions can result in equipment damage.</p>		
[Cascade DI Assign] CSCA	–	[Not Assigned] NO
<p>[Cascade Activation]</p> <p>Access path: [Complete settings] CST → [Cascade] CSC</p> <p>Assign a digital input to start the cascade sequence.</p> <ul style="list-style-type: none"> [Not Assigned] NO: cascade function start not assigned [DI3] LI3: cascade function assigned to digital input DI3 [DI4] LI4: cascade function start assigned to digital input DI4 		

Smoke Extraction

In rare cases, the monitoring functions of the device may be unwanted because they impede the purpose of the application. A typical example is a smoke extractor fan operating as a part of a fire protection system. If a fire occurs, the smoke extractor fan should operate as long as possible, even if, for example, the permissible ambient temperature of the device is exceeded. In such applications, damage to or destruction of the device may be acceptable as collateral damage, for example, to keep other damage from occurring whose hazard potential is assessed to be more severe.

A parameter is provided to disable certain monitoring functions in such applications so that automatic error detection and automatic error responses of the device are no longer active. You must implement alternative monitoring functions for disabled monitoring functions that allow operators and/or master control systems to adequately respond to conditions which correspond to detected errors. For example, if overtemperature monitoring of the device is disabled, the device of a smoke extractor fan may itself cause a fire if errors go undetected. An overtemperature condition can be, for example, signaled in a control room without the device being stopped immediately and automatically by its internal monitoring functions.

⚠ DANGER

MONITORING FUNCTIONS DISABLED, NO ERROR DETECTION

- Only use this parameter after a thorough risk assessment in compliance with all regulations and standards that apply to the device and to the application.
- Implement alternative monitoring functions for disabled monitoring functions that do not trigger automatic error responses of the device, but allow for adequate, equivalent responses by other means in compliance with all applicable regulations and standards as well as the risk assessment.
- Commission and test the system with the monitoring functions enabled.
- During commissioning, verify that the device and the system operate as intended by performing tests and simulations in a controlled environment under controlled conditions.

Failure to follow these instructions will result in death or serious injury.

This function can be used to disable the following monitoring functions:

- [No Power Comm Error] **FWMC**
- [Control Supply Error] **CLF**
- [Fdbus Com Interrupt] **CNF**
- [CANopen Com Interrupt] **COF**
- [In Delta Wiring Error] **DWF**
- [External Error] **EPF1**
- [Fieldbus Error] **EPF2**
- [FDR 2 Error] **FDR2**
- [Mains Freq Error] **FRF**
- [FW Update Error] **FWER**
- [Fware Pairing Err] **FWPF**
- [Internal Error 35] **INFZ**
- [Lock Rotor Error] **LRF**
- [Overcurrent] **OCF**
- [Device Overheat] **OHF**
- [Process Overload] **OLC**
- [Motor Overload] **OLF**
- [Mains Sync Error] **PHF1**
- [Mains Direction Error] **PHF2**
- [Phase Loss] **PHF3**
- [Mains Loss] **PHF4**
- [Phase Inversion] **PIF**
- [Mdb Com Interrupt] **SLF1**
- [PC Com Interrupt] **SLF2**
- [HMI Com Interruption] **SLF3**
- [Simu Mains Detected] **SMPF**
- [AI1 Th Sensor Error] **T1CF**
- [AI1 Th Level Error] **TH1F**
- [Too Long Start Err] **TLSE**
- [Proc Underload] **ULF**
- [Supply Mains UnderV] **USF**

The warnings are still recorded in [Diagnostics] **DIA** → [Diag. data] **DDT** → [Last Warning] **LALR**.

Description	Setting	Factory setting
[Disable Error Detect] INH	–	[Not Assigned] NO
<p>Disable error detection</p> <p>Access path: [Complete settings] CST → [Smoke Extraction] SMOE</p> <p>This parameter can be set to:</p> <ul style="list-style-type: none"> • [Not Assigned] NO • [DI3] LI3: Error inhibition when high level applied to terminal DI3 • [DI4] LI4: Error inhibition when high level applied to terminal DI4 <p>It is possible to assign this parameter on a virtual input via the CMD word, bits 11 to 15. Refer to the fieldbus manuals for the CMD word assignments.</p> <p>Apply a high level to the assigned digital input to inhibit the error detection.</p> <p>[Error detect disabling] INH can be assigned to [DI3] LI3 or [DI4] LI4 in the [Input/Output] IO menu.</p>		

Factory Settings and Customer Configuration

Factory Settings Parameters

The following table is not exhaustive, it covers the essential parameters.

Parameters	Factory setting values
[Mains Voltage] ULN	400 Vac
[Current Limit] ILT	400% of [Motor Nom Current] IN
[Init Starting Torque] TQ0	20% of nominal torque
[Type of stop] STT	[Freewheel] F
[Motor Class] THP	Class 10E protection
[AI1 Th Monitoring] TH1S	[No] NO
Embedded Modbus communication:	
[Modbus Address] ADD	0
[Modbus Baud Rate] TBR	19200 bits per second
[Modbus Format] TFO	8E1, 8 data bits, even parity, 1 stop bit
[Modbus Timeout] TTO	5 seconds

I/O	Assignment
Digital inputs	<ul style="list-style-type: none"> • DI1: STOP (*) • DI2: RUN (*) • DI3: [Freewheel Assign] FFSA • DI4: [Forced Local] LIFLO
Digital outputs	<ul style="list-style-type: none"> • DQ1: [Motor Overload Warn] OLMA • DQ2: [Device Running] RUN
Relay outputs	<ul style="list-style-type: none"> • R1: [Operating State Fault] FLT • R2: [End Of Start] BPS (*) • R3: [Device Running] RUN
Analog output	<ul style="list-style-type: none"> • AQ1: [Motor Current] OCR (0 — 20 mA)

(*): non-assignable

Restore the factory settings

NOTE: This procedure acts on Device Configuration only, while Cybersecurity Profile and Device Image stay untouched.

Step	Action
1	<p>In the [Parameter group list] FRY menu, select the parameter to restore to the factory settings in the following list:</p> <ul style="list-style-type: none"> • [All] ALL : All parameters in all menus (except cybersecurity parameters). • [Device Configuration] DRM : Load [Complete settings] CST menu. • [Motor param] MOT : Load [Motor parameters] MMO menu. • [Comm. menu] COM : Load embedded fieldbus menu. • [Display config.] DIS : Load display menu. • [Fieldbus Module] NET : Load option fieldbus menu.
2	Go to [Go to Factory Settings] GFS
3	<p>The following safety message appears:</p> <div style="border: 1px solid black; padding: 10px; text-align: center;"> <p>⚠ WARNING</p> <p>UNANTICIPATED EQUIPMENT OPERATION</p> <ul style="list-style-type: none"> • Verify that restoring the factory settings or modifying the configuration is compatible with the type of wiring used. • If you are recalling a stored configuration, perform a comprehensive commissioning test to verify correct operation. <p>Failure to follow these instructions can result in death, serious injury, or equipment damage.</p> </div> <p>After reading this safety message, press OK (or ESC to exit).</p>
4	<p>The restoration is finished when the soft starter displays the previous menu.</p> <p>In factory configuration and after a return to "factory settings", [Parameter group list] FRY will be empty.</p>

Save a customer configuration

Maximum three customer parameter sets can be saved on the ATS480.

NOTE: .The **[Parameter group list] FRY** parameter has an impact on the saved customer configuration.

NOTE: This procedure acts on Device Configuration only, while Cybersecurity Profile and Device Image stay untouched.

Step	Action
1	<p>In the [Save Configuration] SCSI menu, select:</p> <ul style="list-style-type: none"> • [Config 1] STR1 to store the customer parameters set 1. • [Config 2] STR2 to store the customer parameters set 2. • [Config 3] STR3 to store the customer parameters set 3.
2	<p>To save, hold down the OK button until returned to the previous menu.</p> <p>The parameter changes back to [No] NO as soon as the operation is completed.</p>

Restore a customer configuration

NOTE: .The **[Parameter group list]** **FRY** parameter has an impact on the restored customer configuration.











NOTE: This procedure acts on Device Configuration only, while Cybersecurity Profile and Device Image stay untouched.

Step	Action
1	<p>In the [Config. Source] FCSI menu to recall a customer configuration, select a parameter in the following list:</p> <ul style="list-style-type: none"> • [Macro Config] INI for the factory settings parameters set. • [Config 1] CFG1 for the customer parameters set 1. • [Config 2] CFG2 for the customer parameters set 2. • [Config 3] CFG3 for the customer parameters set 3.
2	<div style="border: 1px solid black; padding: 10px; text-align: center;"> <p>⚠ WARNING</p> <p>UNANTICIPATED EQUIPMENT OPERATION</p> <ul style="list-style-type: none"> • Verify that restoring the factory settings or modifying the configuration is compatible with the type of wiring used. • If you are recalling a stored configuration, perform a comprehensive commissioning test to verify correct operation. <p>Failure to follow these instructions can result in death, serious injury, or equipment damage.</p> </div> <p>Press OK to select the customer parameters to recall.</p>

HMI navigation

What's in This Part

1 [Simply Start] <small>SYS</small>	142
2 [Monitoring] <small>PROT</small>	143
3 [Complete settings] <small>CST</small>	157
4 [Input/Output] <small>IO</small>	183
5 [2nd Mot Parameters] <small>ST2</small>	194
6 [Communication] <small>COM</small>	195
7 [Display] <small>MON</small>	209
8 [Diagnostics] <small>DIA</small>	219
9 [Device Management] <small>DMT</small>	223
10 [My preferences] <small>MYP</small>	239
Functions Compatibility Table	246

 1 [Simply Start] <small>SYS</small>	Minimum parameters to start and stop a motor.
 2 [Monitoring] <small>PROT</small>	Electrical and thermal monitoring functions.
 3 [Complete settings] <small>CST</small>	Advanced settings for fine-tuning.
 4 [Input/Output] <small>IO</small>	Inputs/Outputs configuration.
 5 [2nd Mot Parameters] <small>ST2</small>	Second set of essential parameters.
 6 [Communication] <small>COM</small>	Fieldbus communication configuration.
 7 [Display] <small>MON</small>	Monitoring of key values.
 8 [Diagnostics] <small>DIA</small>	Soft starter history, current state and motor thermal state.
 9 [Device Management] <small>DMT</small>	Cybersecurity, time setting, firmware update and factory settings.
 10 [My preferences] <small>MYP</small>	Device and display terminal configuration.

1 [Simply Start] SYS

About this menu

The  [Simply Start] SYS menu provides:

- The minimum parameters to start and stop a class 10E induction motor in torque control.
- The list of modified parameters in the **[Modified parameters]** LMD sub-menu. It is possible to edit the modified parameters from this sub-menu.

For the complete description of this menu refer to **[Simply Start]** SYS, page 108.

2 [Monitoring] PROT

What's in This Chapter

2.2 [Process underload] ULD..... 150
 2.4 [Process overload] OLD..... 152
 2.11 [Thermal monitoring] TPP..... 153

About this menu

This menu provides parameters for monitoring the motor mains and temperature, overloads, underloads and temperature measurements on the AI1/PTC1 terminal.

 [Monitoring] PROT menu navigation

2.1 [Motor Class] THP
2.2 [Process underload] ULD
[Underload Activation] UDLA
[Unld Detect Delay] ULT
[Unld.Thr.0.Speed] LUL
[Underload ErrorResp] UDL
2.3 [Too Long Start] TLS

2.4 [Process overload] OLD
[Overload Activation] ODLA
[Ovld Detection Delay] TOL
[Overload Threshold] LOC
[Overload ErrorResp] ODL
2.5 [Phase Inversion Mon] PHR
2.6 [Time Before Restart] TBS
2.7 [Phase Loss Monit] PHP
2.8 [Phase Loss Cur Thd] PHL

2.9 [Mot Th State Reset] RTHR
2.10 [Gamma Sync Error] TSC
2.11 [Thermal monitoring] TPP
[AI1 Th Monitoring] TH1S
[AI1 Type] AI1T
[AI1 Th Error Resp] TH1B
[AI1 filter] AI1F
[AI1 Th Error Level] TH1F
[AI1 Th Warn Level] TH1A
[AI1 Th Value] TH1V

Motor Thermal Protection Class

The soft starter continuously calculates the temperature rise of the motor based on the controlled nominal current **In** and the actual current absorbed.

Temperature rises can be caused by a low or high overload with a long or short duration. The tripping curves on the following pages are based on the relationship between the actual current absorbed **I** and the (adjustable) nominal motor current **In**.

Standard IEC 60947-4-2 defines the protection classes providing the starting capacities of the motor (warm or cold start) without thermal detected errors. Different protection classes are given for a **cold** state (corresponding to a stabilized motor thermal state, switched off) and for a **warm** state (corresponding to a stabilized motor thermal state, at nominal power).

The soft starter factory setting of the protection **[Motor Class] THP** is **[Class 10E] 10E**.

The thermal state displayed by the parameter **[Motor Therm State] THR** in the menu **[Display] SUP → [Thermal Monitoring] TPM** corresponds to the iron time constant:

- An overload warning is activated if the motor exceeds 110% of the motor thermal state, if the warning **[Motor Overload Warn] OLMA** is set in a warning group in the **[Diagnostics] DIA → [Warnings] ALR** menu.
- A detected thermal error stops the motor if it exceeds 125% of the thermal state.

In the event of a prolonged start, the thermal error can triggers below 125% of the thermal state.

The relay R3 can be assigned to the thermal detected error.

If the soft starter is switched-off, the thermal state is stored in EEPROM. When the soft starter is powered-on again, the duration of the power off is taken into account to calculate a new thermal state.

As long as the thermal state is above 110%, it is not possible to clear the detected error (except in case of power cycle of the soft starter).

If a special motor is used (flameproof, submersible, etc.) thermal monitoring should be provided by external thermal sensors.

Cold State

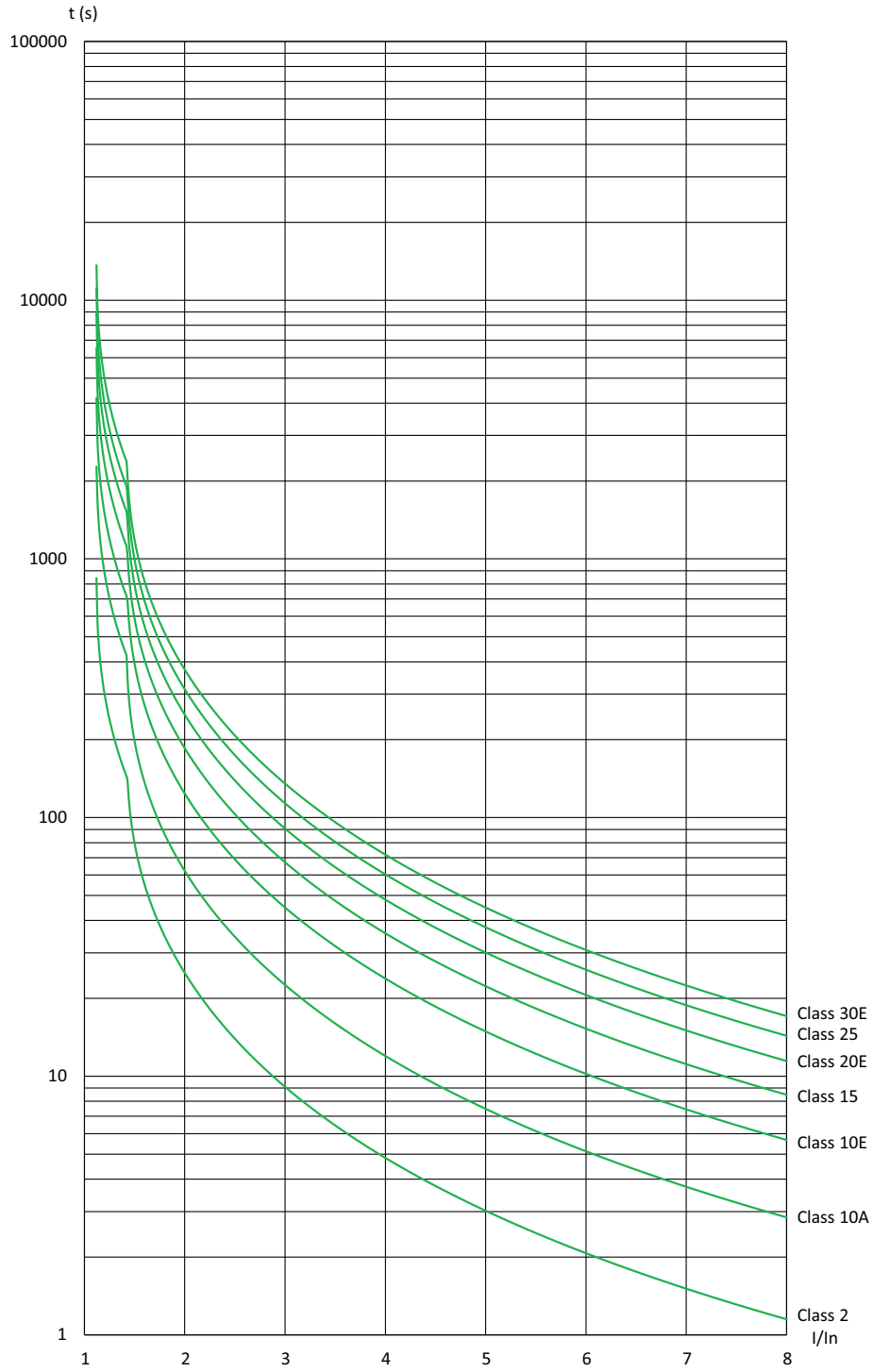

Trip time for normal duty (class 10E)		Trip time for heavy duty (class 20E)	
3 ln	5 ln	3.5 ln	5 ln
45 s	16 s	62 s	30 s

Warm State

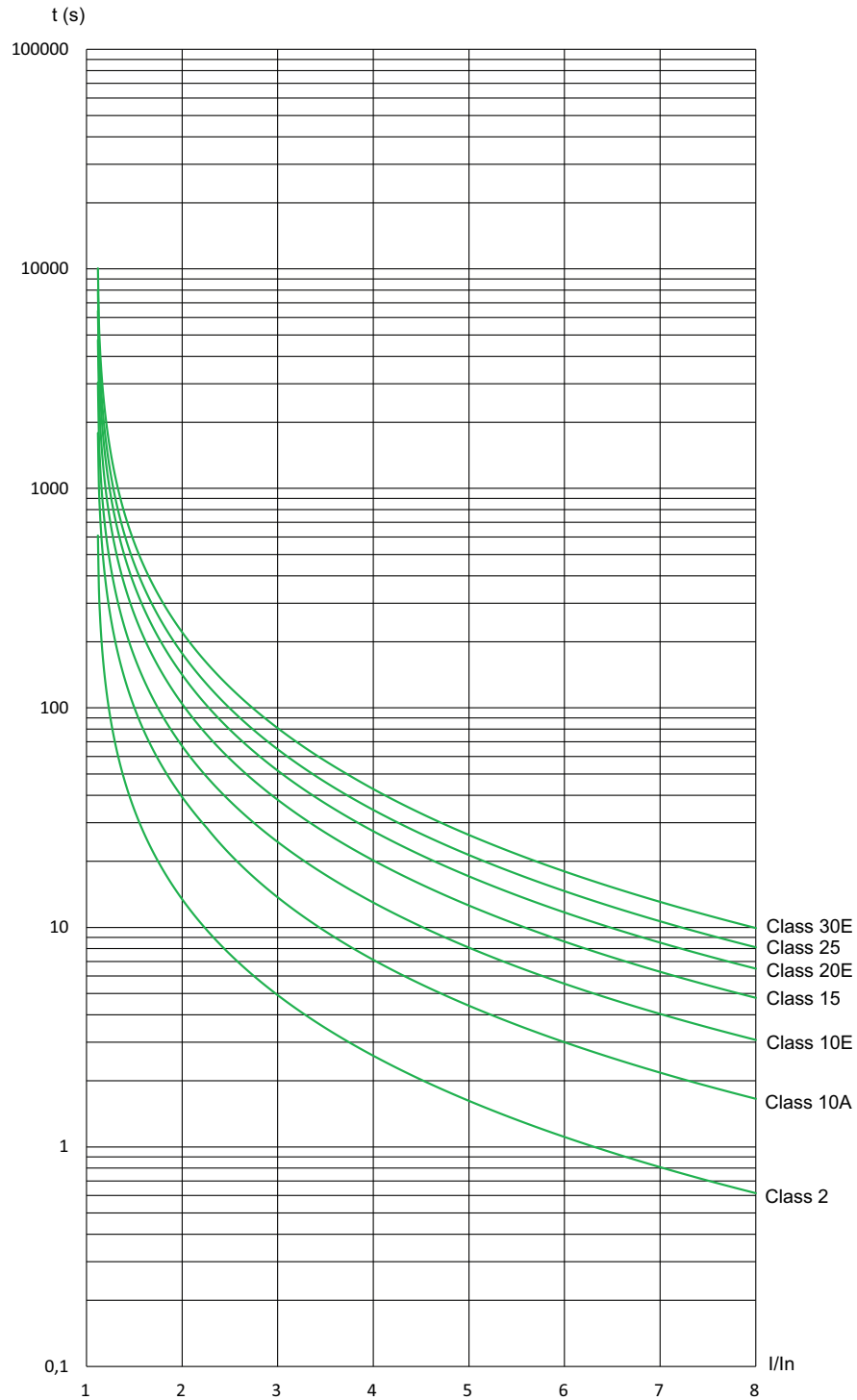

Triggering time for normal duty (class 10E)		Triggering time for heavy duty (class 20E)	
3 In	5 In	3.5 In	5 In
25 s	8 s	36 s	18 s

HMI label	Setting	Factory setting
2.1 [Motor Class] THP	–	[Class 10E] 10E
<p>Motor thermal protection class</p> <p>Access path: [Monitoring] PROT</p> <p>If the parameter [Cascade] CSC is set to [ON] ON , [Motor Class] THP is automatically set to [No Protection] NO .</p> <p>[Motor Class] THP is NOT set back to the factory setting when [Cascade] CSC is set back to [OFF] OFF .</p> <ul style="list-style-type: none"> • [No Protection] NO : no motor protection • [Class 2] 2 sub-class 2 • [Class 10A] 10A (normal duty) • [Class 10E] 10E (normal duty, includes class 10) • [Class 15] 15 • [Class 20E] 20E (heavy duty) • [Class 25] 25 • [Class 30E] 30E 		
2.3 [Too Long Start] TLS	10...999 seconds or [No] NO	[No] NO
<p>Excessive starting time</p> <p>Access path: [Monitoring] PROT</p> <p>If the starting time exceeds the value set in [Too Long Start] TLS , the soft starter triggers the error [Too Long Start Err] TLSF . The conditions for the end of starting are:</p> <ul style="list-style-type: none"> • Mains voltage applied to the motor • And motor current less than 1.3 In. <p>This parameter can be set to:</p> <ul style="list-style-type: none"> • 10...999 seconds • [No] NO : Excessive starting time monitoring deactivated 		
2.5 [Phase Inversion Mon] PHR	–	[No] NO
<p>Phase Inversion Monitoring</p> <p>Access path: [Monitoring] PROT</p> <p>If the mains input phases are not in the configured order, the soft starter triggers and displays the error [Phase Inversion] PIF .</p> <ul style="list-style-type: none"> • [No] NO : no monitoring • [123] 123 : forward (L1 - L2 - L3) • [321] 321 : reverse (L1 - L3 - L2) 		

HMI label	Setting	Factory setting
2.6 [Time Before Restart] TBS	0...999 s	2 s

Time before motor restart

Access path: [Monitoring] PROT

This parameter sets the time delay between two starts. It helps to prevent too many starts in a short time which may overheat the motor.

If the motor stops with :

- [Type of stop] STT set to [Freewheel] F , the time delay [Time Before Restart] TBS starts when a Stop order is applied.
- [Type of stop] STT set to [Deceleration] D , the time delay [Time Before Restart] TBS starts as soon as the time, dependant of the setting [End Of Deceleration] EDC , is elapsed.
- [Type of stop] STT set to [Braking] B , the time delay [Time Before Restart] TBS starts as soon as the motor stops rotating.

In 2-wire control, the motor restarts if:

1. [Time Before Restart] TBS is elapsed
2. Run order is applied

In 3-wire control, the motor restarts if:

1. [Time Before Restart] TBS is elapsed
2. Run order is present

If the Run command is applied and maintained, the start of the motor can be delayed for the amount of time set to the parameter [Time Before Restart]

⚠ WARNING

UNANTICIPATED EQUIPMENT OPERATION

- Verify that setting a high value to the parameter [Time Before Restart] does not result in unsafe conditions.
- Always consider that the equipment is in the operating state Operation Enabled as soon as a Run command is applied even if the time delay to restart is not elapsed.

Failure to follow these instructions can result in death, serious injury, or equipment damage.

HMI label	Setting	Factory setting
2.7 [Phase Loss Monit] PHP	[Yes] YES or [No] NO	[Yes] YES
<p>Phase loss monitoring</p> <p>Access path: [Monitoring] PROT</p> <div style="border: 1px solid black; padding: 5px; margin: 5px 0;"> <p style="text-align: center;">⚠️⚠️ DANGER</p> <p>HAZARD OF ELECTRIC SHOCK, EXPLOSION OR ARC FLASH</p> <p>If output phase monitoring is disabled, phase loss and, by implication, accidental disconnection of cables, are not detected.</p> <ul style="list-style-type: none"> Verify that the setting of this parameter does not result in unsafe conditions. <p>Failure to follow these instructions will result in death or serious injury.</p> </div> <p>This parameter enables phase loss monitoring.</p> <p>If the motor current is below the threshold set in [Phase Loss Thd] PHL and [Phase Loss Monit] PHP is set to [ON] ON , the soft starter triggers the [Phase Loss] PHF3 error.</p> <ul style="list-style-type: none"> [OFF] OFF : phase loss monitoring disabled [ON] ON : phase loss monitoring enabled 		
2.8 [Phase Loss Thd] PHL	5...10% of soft starter current rating	10%
<p>Phase loss threshold</p> <p>Access path: [Monitoring] PROT</p> <p>If the motor current drops down below this threshold on one phase for 0.5 seconds or on all three phases for 0.2 seconds, the soft starter triggers the [Phase Loss] PHF3 error.</p> <p>Can be set between 5 and 10% of the soft starter current rating.</p> <p>This parameter is visible if [Phase Loss Monit] PHP is set to [Yes] YES .</p>		
2.9 [Mot Th State Reset] RTHR	[Yes] YES or [No] NO	[No] NO
<p>Reset motor thermal state</p> <p>Access path: [Monitoring] PROT</p> <p>This parameter resets the motor thermal state calculated by the soft starter.</p> <ul style="list-style-type: none"> [Yes] : Reset calculated motor thermal state [No] : Function inactive 		
2.10 [Gamma Sync Error] TSC 	0...10 or [No] NO	8
<p>Gamma synchro error</p> <p>Access path: [Monitoring] PROT</p> <p>This parameter sets the threshold before triggering the error [Mains Sync Error] PHF1 in case of bad mains phase synchronization.</p> <p>The lower is the set value, the more sensitive is the synchronization monitoring.</p>		

2.2 [Process underload] ULD

About this Menu

Access path: [Monitoring] PROT → [Process underload] ULD

This menu provides the parameters to configure the motor underload detection and management.

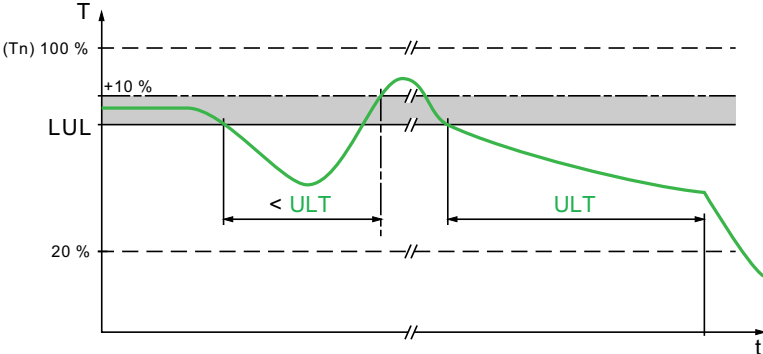
HMI label	Setting	Factory setting
[Underload Activation] UDLA	[Yes] YES or [No] NO	[No] NO
<p>Underload activation</p> <p>Access path: [Monitoring] PROT → [Process underload] ULD</p> <p>This parameter enable underload monitoring when the motor is running.</p> <p>When the soft starter is in [Running] RUN state (established regime) and if the motor torque is below the threshold set in [Underload Threshold] LUL for a duration longer than the value set in [Unld Detect Delay] ULT, the soft starter behaves according to the value set in [Underload ErrorResp] UDL.</p>  <p>This parameter is forced to [No] NO if [Cascade Activation] CSC is set to [Yes] YES.</p>		
[Unld Detect Delay] ULT	0...100 s	60 s
<p>Motor underload time</p> <p>Access path: [Monitoring] PROT → [Process underload] ULD</p> <p>This parameter is used to set the time delay to activate [Warning] ALA or [Error] DEF when the [Underload Threshold] LUL is reached.</p> <p>It is reset to zero if the torque rises above the value of [Underload Threshold] LUL + 10% (hysteresis).</p> <p>This parameter can be accessed if [Underload Activation] UDLA is set to [Yes] YES.</p>		
[Underload Threshold] LUL	20...100% of Tn	60%
<p>Underload threshold</p> <p>Access path: [Monitoring] PROT → [Process underload] ULD</p> <p>This parameter is used to set the motor torque threshold value for [Underload Activation] UDLA.</p> <p>This parameter can be set between 20% and 100% of the nominal motor torque.</p> <p>This parameter can be accessed if [Underload Activation] UDLA is set to [Yes] YES.</p>		

HMI label	Setting	Factory setting
[Underload ErrorResp] UDL	–	[No] NO
<p>Response to underload error</p> <p>Access path: [Monitoring] PROT → [Process underload] ULD</p> <p>This parameter sets the soft starter behavior when the motor torque is below the threshold set in [Underload Threshold] LUL for a duration longer than the value sets in [Undl Detect Delay] ULT.</p> <ul style="list-style-type: none"> • [Yes] YES: trigger the [Proc Underload] ULF error • [No] NO: trigger a warning (internal bit and configurable digital output) <p>This parameter can be accessed if [Underload Activation] UDLA is set to [Yes] YES.</p>		

2.4 [Process overload] OLD

About this Menu

Access path: [Monitoring] PROT → [Process overload] OLD

This menu provides the parameters to configure the motor overload detection and management.

HMI label	Setting	Factory setting
[Overload Activation] ODLA	–	[No] NO
<p>Overload activation</p> <p>Access path: [Monitoring] PROT → [Process overload] OLD</p> <p>This parameter enables overload monitoring when the motor is active.</p> <p>If the motor current exceeds the threshold set in [Overload Threshold] LOC for a duration longer than the value set in [Ovld Detection Delay] TOL, the soft starter behaves according to the value set in [Overload ErrorResp] ODL.</p> <ul style="list-style-type: none"> • [Yes] YES • [No] NO <p>This parameter is forced to [No] NO if [Cascade Activation] CSC is set to [Yes] YES.</p>		
[Ovld Detection Delay] TOL	0...100 s	10 s
<p>Overload detection delay</p> <p>Access path: [Monitoring] PROT → [Process overload] OLD</p> <p>This parameter is to sets the time delay to activate [Warning] ALA or [Error] DEF when the [Overload Threshold] LOC is reached.</p> <p>It is reset to zero if the current drops down below the value of [Overload Threshold] LOC - 10% (hysteresis).</p> <p>This parameter can be accessed if [Overload Activation] ODLA is set to [Yes] YES.</p>		
[Overload Threshold] LOC	50...300% of In	80%
<p>Current overload threshold</p> <p>Access path: [Monitoring] PROT → [Process overload] OLD</p> <p>This parameter is used to set the motor current threshold value for [Overload Activation] ODLA.</p> <p>This parameter can be set between 50% and 300% of [Motor Nom Current] IN.</p> <p>This parameter can be accessed if [Overload Activation] ODLA is set to [Yes] YES.</p>		
[Overload ErrorResp] ODL	–	[No] NO
<p>Response to overload error</p> <p>Access path: [Monitoring] PROT → [Process overload] OLD</p> <p>This parameter sets the soft starter behavior when the motor current exceeds the threshold set in [Overload Threshold] LOC for a duration longer than the value set in [Ovld Detection Delay] TOL.</p> <ul style="list-style-type: none"> • [No] NO: trigger a warning (internal bit and configurable digital output) • [Yes] YES: trigger the [Process Overload] OLC error <p>This parameter can be accessed if [Overload Activation] ODLA is set to [Yes] YES.</p>		

2.11 [Thermal monitoring] TPP

Access path: [Monitoring] PROT → [Thermal monitoring] TPP

About this Menu

This menu provides the parameters to measure a temperature with a thermal sensor wired of the PTC1/AI1 terminal (cabinet, a room, etc...).

PTC and PT100 thermal sensors are supported by this function.

The function gives the possibility to manage 2 types of monitoring:

- the soft starter triggers a warning without stopping the application.
- the soft starter triggers an error and stops the application.

The monitoring function takes into account the following events:

- Overheating
- Sensor break (loss of signal)
- Sensor short-circuit

- (a): PT100 state
- (b): Short circuit
- (c): Short circuit level
- (d): Cold
- (e): Hysteresis
- (f): Hot
- (g): Open circuit level
- (h): Open circuit
- (i): PT100 value

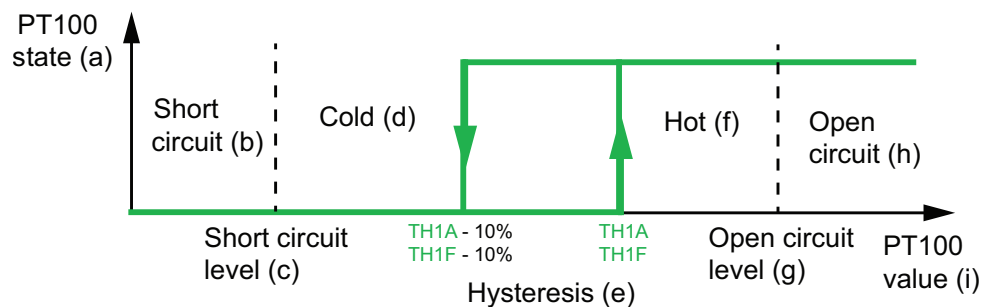

NOTE: [Thermal monitoring] TPP does not deactivate the motor thermal monitoring provided by the calculation. Both types of monitoring can operate in parallel.

Type of Thermal Sensor Selection

A thermal sensor fixed on a motor can be connected on the soft starter. By enabling this capability, the soft starter measures the temperature of the motor according to the sensor type and connection.

If the length between the motor and the soft starter is high, prefer a connection PT100 with 3 wires for a better accuracy.

PTC thermal sensors are adapted for to detect an overheating. PT100 thermal sensors allows to monitor in real-time the temperature of the motor.

For 2-Wire Sensors

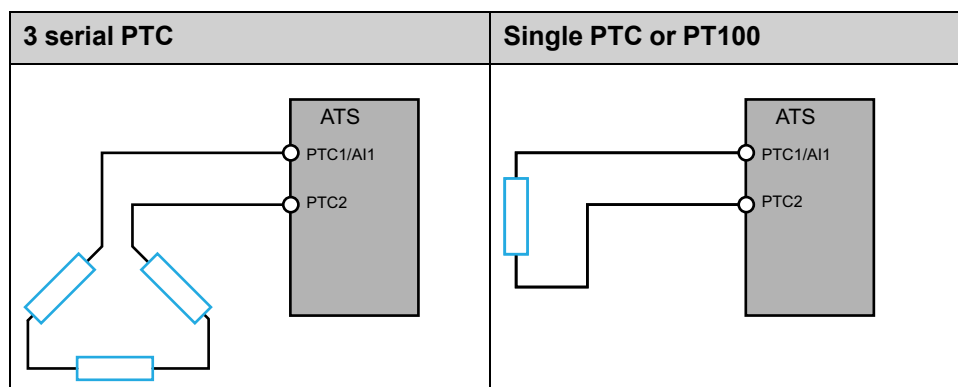

For 3-Wire Sensors

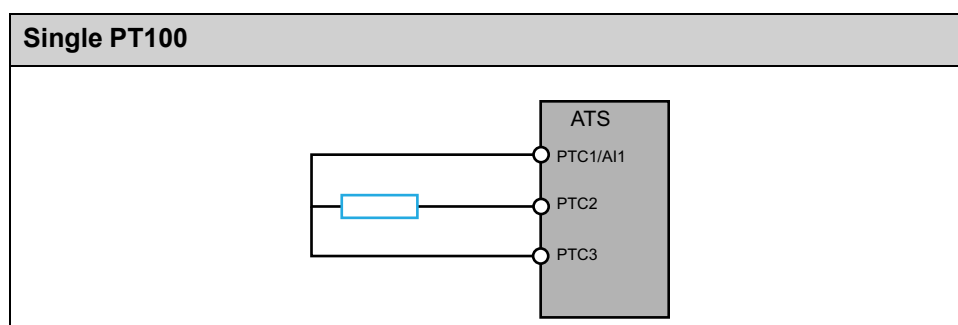

HMI label	Setting	Factory setting
[AI1 Th Monitoring] TH1S	–	[Not Configured] NO
<p>Activation of the thermal monitoring on AI1</p> <p>Access path: [Monitoring] PROT → [Thermal monitoring] TPP</p> <p>This parameter enables the thermal sensor monitoring from thermal sensors PTC or PT100 on the terminal PTC1/AI1.</p> <ul style="list-style-type: none"> [Not Configured] NO: Disable thermal monitoring on PTC1/AI1 [AI1] AI1: Enable thermal monitoring on PTC1/AI1 and trigger an error or warning on detection 		
[AI1 Type] AI1T	–	[PTC] PTC
<p>Configuration of AI1</p> <p>Access path: [Monitoring] PROT → [Thermal monitoring] TPP</p> <p>This parameter sets the type of thermal sensors wired to the terminal PTC1/AI1.</p> <ul style="list-style-type: none"> [PTC] PTC: 1 to 6 PTC in serial is used. [PT100] 1PT2: 1 PT100 connected with 2 wires is used. [PT100 in 3 wires] 1PT23: 1 PT100 connected with 3 wires is used. <p>This parameter can be accessed if [AI1 Th Monitoring] TH1S is set to [AI1] AI1.</p>		
[AI1 filter] AI1F	0...10 s	0 s
<p>AI1 filter</p> <p>Access path: [Input/Output] IO → [AI1 configuration] AI1</p> <p>This parameter set the cutoff time of the low filter for PTC1/AI1.</p>		

HMI label	Setting	Factory setting
[AI1 Th Error Resp] TH1B	–	[Freewheel Stop] YES
<p>Response to thermal error for AI1</p> <p>Access path: [Monitoring] PROT → [Thermal monitoring] TPP</p> <p>This parameter sets the behavior of the soft starter when the threshold set in [AI1 Th Error Level] TH1F is reached on the terminal PTC1/AI1.</p> <ul style="list-style-type: none"> • [Ignore] NO: Soft starter doesn't trigger an error • [Freewheel Stop] YES: Error is triggered and motor stops in freewheel • [Configured Stop] STT: Motor stops according to the value sets in [Type of stop] STT, no error is triggered • [Deceleration] DEC: Motor stops in deceleration and an error is triggered at the end of deceleration • [Braking] BRK: Motor stops in dynamic braking and an error is triggered at the end of braking <p>Set [Type of stop] STT to [Deceleration] DEC or [Braking] BRK to use those settings for [AI1 Th Error Resp] TH1B.</p> <p>Those settings will be kept in memory even if you change [Type of stop] STT again. You can set a different stop for normal use and for [AI1 Th Error Resp] TH1B.</p> <p>For more information about the type of stops, refer to Set Stop Profile, page 113.</p>		
[AI1 Th Error Level] TH1F	–15.0...200.0°C	110.0°C
<p>Thermal error level for AI1</p> <p>Access path: [Monitoring] PROT → [Thermal monitoring] TPP</p> <p>This parameter sets the threshold for triggering the [AI1 Th Level Error] TH1F when [AI1 Th Monitoring] TH1S is set to [AI1] AI1.</p> <p>The [AI1 Th Level Error] TH1F can be reset at [AI1 Th Error Level] TH1F – 10%, refer to the curve at the beginning of this chapter.</p> <p>This parameter can be accessed if [AI1 Type] AI1T is set to [PT100] 1PT2 or [PT100 in 3 wires] 1PT23.</p>		
[AI1 Th Warn Level] TH1A	–15.0...200.0°C	90.0°C
<p>Thermal warning level for AI1</p> <p>Access path: [Monitoring] PROT → [Thermal monitoring] TPP</p> <p>This parameter sets the threshold for triggering a warning when [AI1 Th Monitoring] TH1S is set to [AI1] AI1.</p> <p>The warning will trigger at the set temperature only if [AI1 Th Warning] TP1A is set to a warning group in [Diagnostics] DIA → [Warnings] ALR.</p> <p>This parameter is visible if [AI1 Type] AI1T is set to [PT100] 1PT2 or [PT100 in 3 wires] 1PT23.</p> <p>The warning message can be reset at [AI1 Th Error Level] TH1F – 10%, refer to the curve at the beginning of this chapter.</p>		
[AI1 Th Value] TH1V	–15...200°C	–
<p>AI1 thermal value</p> <p>Access path: [Monitoring] PROT → [Thermal monitoring] TPP</p> <p>Access path: [Display] SUP → [Thermal Monitoring] TPM</p> <p>This parameter displays the current temperature measurement by the wired thermal sensors.</p> <p>In case of short circuit with the thermal sensor, the displayed value will be –35°C (-31°F) (86,19 Ohm).</p> <p>In case of open circuit with the thermal sensor, the displayed value will be 206.6°C (404°F) (177,68 Ohm).</p> <p>This parameter can be accessed if [AI1 Type] AI1T is set to [PT100] 1PT2 or [PT100 in 3 wires] 1PT23.</p>		

HMI label	Setting	Factory setting
[Motor Therm State] THR	0...300 %	–
<p>Motor thermal state</p> <p>Access path: [Display] SUP → [Thermal Monitoring] TPM</p> <p>This parameter monitors the motor thermal state. 100% corresponds to the nominal thermal state at the nominal motor current set to [Motor Nom Current] IN.</p>		
[Device Thermal State] THS	0...200 %	–
<p>Device thermal state</p> <p>Access path: [Display] SUP → [Thermal Monitoring] TPM</p> <p>This thermal estimation is provided by a probe fitted on the heatsink.</p> <p>The value 100 % represents the Nominal thermal state.</p> <ul style="list-style-type: none"> • <u>Warning:</u> <ul style="list-style-type: none"> ◦ A warning [Device Th Warn] THA is raised if [Device Thermal State] > 110%. ◦ The warning will be cleared if [Device Thermal State] < 105%. • <u>Error:</u> <ul style="list-style-type: none"> ◦ An error [Device Overheat] OHF is triggered if [Device Thermal State] THS > 118%. ◦ The error can be reset if [Device Thermal State] THS < 100%. 		

3 [Complete settings] CST

What's in This Chapter

- 3.1 [Motor parameters] MPA 158
- 3.2 [Mains contactor cmd] LLC 160
- 3.3 [Motor wiring] MWMT 161
- 3.4 [Preheating] PRF 163
- 3.5 [Start & Stop] SSP 165
- 3.6 [Cascade] CSC 172
- 3.7 [Smoke Extraction] SMOE 174
- 3.8 [Command channel] CCP 175
- 3.9 [Error/Warn handling] CSWM 178

About this menu

This menu provides access to parameters used in more complex functions than the [Simply Start] SYS menu.



[Complete settings] CST menu navigation

3.1 [Motor parameters] MPA	[Boost] BST	[Forced Local Assign] FLO
[Motor Nom Current] IN	[Init Starting Voltage] V0	[Forced Local Chan] FLOC
[Current Limit] ILT	[Type of stop] STT	[Time-out forc. local] FLOT
[Mains Voltage] ULN	[Freewheel Assign] FFSA	3.9 [Error/Warn handling] CSWM
[Mains Frequency] FRC	[Deceleration] DEC	[External error] ETF –
3.2 [Mains contactor cmd] LLC	[End Of Deceleration] EDC	[Ext Error assign] ETF
[Mains Contactor] LLC	[Braking Level] BRC	[Ext Error Condition] LET
[Device Lock] LES	[DC Braking Time] EBA	[Auto Fault Reset] ATR
[Mains V. time out] LCT	[Deceleration Gain] TIG	[Fault Reset Time] TAR
3.3 [Motor wiring] MWMT	[Torque Limit] TLI	[Disable Error Detect] INH
[Inside Delta] DLT	[Stator Loss Comp] LSC	[Fault reset] RST
[In Delta Diag] DLTL	3.6 [Cascade] CSC	[Fault Reset Assign] RSF
[In Delta Diag Status] DLTS	[Cascade Activation] CSC	[Th Error Reset Assign] RSFT
[Small Motor Test] SST	[Cascade DI Assign] CSCA	[Product restart] RP
3.4 [Preheating] PRF	3.7 [Smoke Extraction] SMOE	[Warn groups config] AGCF
[Preheating Assign] PRHA	[Disable Error Detect] INH	[Warn grp 1 definition] A1C
[Preheat Level] IPR	3.8 [Command channel] CCP	[Warn grp 2 definition] A2C
[Time Before Preheat] TPR	[Control Mode] CHCF	[Warn grp 3 definition] A3C
3.5 [Start & Stop] SSP	[Command Switching] CCS	[Warn grp 4 definition] A4C
[Control Mode] CLP	[Cmd channel 1] CD1	[Warn grp 5 definition] A5C
[Acceleration] ACC	[Cmd channel 2] CD2	[Control Supply Loss] CLB
[Init Starting Torque] TQ0	[Copy Ch1-Ch2] COP	

3.1 [Motor parameters] MPA

Access path: [Complete settings] CST → [Motor parameters] MPA

About this Menu

This menu provides the parameters to set the motor electrical characteristics and the current limit.

HMI label	Setting	Factory setting
[Motor Nom Current] IN	–	(1)
<p>Nominal current</p> <p>Access path: [Complete settings] CST → [Motor parameters] MPA</p> <p>Adjust the value of [Motor Nom Current] IN according to the rated motor current indicated on the motor nameplate.</p> <p>[Motor Nom Current] IN have two ranges of values:</p> <ul style="list-style-type: none"> 0.4...1.3 of soft starter rating (I_e, rated operational current) [Inside Delta] DLT is set to [No] NO. If the rated motor current is below 0.4 I_e, use a lower rated soft starter. If above 1 I_e, the soft starter must be by-passed. 0.69...2.25 of I_e if [Inside Delta] DLT is set to [Yes] YES. <p>The value set to [Motor Nom Current] IN determines the current of the motor thermal monitoring, depending on which motor class is set. For more information regarding the motor thermal monitoring and the selection of the motor class, refer to 2 [Monitoring] PROT, page 143.</p> <p>For more information about [Inside Delta] DLT refer to Connection Inside The Delta Of The Motor, page 119.</p> <p>(1) Factory setting of [Motor Nom Current] IN corresponding to the usual value of a 4-pole 400 V standardized motor and [Inside Delta] DLT is set to [No] NO.</p>		
[Current Limit] ILT	150...700%	400% of [Motor Nom Current] IN
<p>Motor limiting current</p> <p>Access path: [Complete settings] CST → [Motor parameters] MPA</p> <p>The RMS motor line current will be limited to [Current Limit] ILT x [Motor Nom Current] IN.</p> <p>[Current Limit] ILT max setting is limited to</p> <ul style="list-style-type: none"> If in-line connection: $500\% \times I_e / I_N$ If inside delta connection: $500\% \times I_e / (I_N / \sqrt{3})$ <p>In every cases the [Current Limit] ILT max setting will not exceed 700% of nominal motor line current.</p> <p>If [Inside Delta] DLT is set to [Yes] YES, the factory setting is 700% of [Motor Nom Current] IN.</p> <p>The current limit setting is always active during start up and overrides all other settings.</p>		

HMI label	Setting	Factory setting
<p>Example 1 in-line connection:</p> <p>ATS480C21Y, with $I_e = 210$ A [Motor Nom Current] $I_N = 195$ A [Current Limit] $ILT = 500\%$ (under max setting : $500\% \times I_e / I_N = 5 \times 210 / 195 = 538\%$) Current limitation = $500\% \times 195 = 975$ A</p> <p>Example 2 inside delta connection:</p> <p>ATS480C21Y, with $I_e = 210$ A [Motor Nom Current] $I_N = 338$ A [Current Limit] $ILT = 500\%$ (under max setting : $500\% \times I_e / (I_N / \sqrt{3}) = 5 \times 210 / (338 / \sqrt{3}) = 538\%$) Current limitation = $500\% \times 338 = 1690$ A</p>		
[Mains Voltage] ULN	170...750 V	400 V
<p>Mains voltage</p> <p>Access path: [Complete settings] CST → [Motor parameters] MPA</p> <p>[Mains Voltage] of the soft starter. For more information refer to Set The Mains Voltage, page 111.</p>		
[Mains Frequency] FRC	–	[Auto] AUTO
<p>Mains frequency</p> <p>Access path: [Complete settings] CST → [Motor parameters] MPA</p> <p>Set the expected mains frequency.</p> <ul style="list-style-type: none"> • [Auto] AUTO: Automatic recognition of the mains frequency, tolerance of 5% • [50Hz] 50: Expected frequency at 50 Hz, tolerance of 20% • [60Hz] 60: Expected frequency at 60 Hz, tolerance of 20% <p>If the mains frequency goes out of the tolerance of the expected frequency, a [Mains Freq Error] FRF error triggers.</p>		

3.2 [Mains contactor cmd] LLC

Access path: [Complete settings] CST → [Mains contactor cmd] LLC

About this Menu

This menu provides the parameters to manage a line contactor upstream the soft starter.

NOTE: Refer to Application Diagrams, page 61 for more information.

HMI label	Setting	Factory setting
[Mains Contactor] LLC	[Not Assigned] NO or [R3] R3	[Not Assigned] NO
<p>Mains contactor control</p> <p>Access path: [Complete settings] CST → [Mains contactor cmd] LLC</p> <p>This parameter sets the external mains supply contactor command. The soft starter can command an external contactor placed upstream in the main supply via the relay R3, allowing to close or open the mains supply of the soft starter with a relay command.</p> <p>The relay command is based on the Run / Stop commands and the detected errors:</p> <ul style="list-style-type: none"> • The external contactor command is activated by a Run or Pre-heating command • The mains contactor output is deactivated: <ul style="list-style-type: none"> ◦ At the end of a braking, deceleration or when the motor switches to freewheel after a Stop command ◦ When an error is detected <p>This parameter cannot be set to [R3] R3 if the relay is already assigned to another function in the menu [Input/Output] IO → [R3 configuration] R3</p>		
[Device Lock] LES	–	[Not Assigned] NO
<p>Device lock assignment</p> <p>Access path: [Complete settings] CST → [Mains contactor cmd] LLC</p> <p>This parameter sets a digital input, DI3 or DI4, to lock the device. When this input is activated with a low level, the relay assigned to [Mains Contactor] LLC is forced to open, which opens the mains contactor and stops the motor in freewheel.</p> <p>To restart the motor, deactivate the digital input command and apply a new Run order.</p> <ul style="list-style-type: none"> • [Not Assigned] NO: No input assigned. • [DI3] LI3: Digital input DI3 assigned, also assign [DI3 assignment] L3A to [Device Lock] LILES • [DI4] LI4: Digital input DI4 assigned, also assign [DI4 assignment] L4A to [Device Lock] LILES <p>This parameter can be accessed if [Mains Contactor] LLC is set to [R3] R3.</p>		
[Mains V. time out] LCT	1...999 s	5 s
<p>Mains V. time out</p> <p>Access path: [Complete settings] CST → [Mains contactor cmd] LLC</p> <p>This parameter sets the time before triggering the error [Input Contactor] LCF if the soft starter does not detect the mains after mains contactor activation .</p>		

3.3 [Motor wiring] MWM T

Access path: [Complete settings] CST → [Motor wiring] MWM T

About this Menu

This menu provides the parameters to connect the soft starter in the motor delta winding and to check the wiring of the soft starter with a small motor.

HMI label	Setting	Factory setting
[Inside Delta] DLT	[No] NO or [Yes] YES	[No] NO
<p>Starter with delta winding in series connection</p> <p>Access path: [Complete settings] CST → [Motor wiring] MWM T</p> <div style="border: 1px solid black; padding: 5px; text-align: center;"> <p>NOTICE</p> <p>DESTRUCTION OF THYRISTOR</p> <p>Only set the parameter [Inside Delta] DLT to [Yes] YES if the mains voltage does not exceed 415 Vac.</p> <p>Failure to follow these instructions can result in equipment damage.</p> </div> <p>This parameter enables the soft starter to run inside the motor delta windings. For more information refer to Connection Inside The Delta Of The Motor, page 119.</p> <ul style="list-style-type: none"> • [No] NO: disable start inside the motor delta windings • [Yes] YES: enable start inside the motor delta windings <p>The parameter [Inside Delta] DLT must be set to [Yes] YES before the settings of the parameters available in the menu [Simply Start] SYS → [Simply start] SIM, otherwise they could be modified and set back to their default values.</p> <p>[Type of stop] STT is automatically set to [Freewheel] F if it was previously set to [Braking] B.</p> <p>NOTE:</p> <ul style="list-style-type: none"> • If a bypass contactor is used, [Phase Loss] PHF3 error detection can be extended. • Setting [Inside Delta] DLT to [Yes] YES to yes can erase the parameters in the menu [Simply Start] SYS → [Simply start] SIM. Verify the value set to those parameters before starting the motor. 		
[In Delta Diag] DLT L	–	[No] NO
<p>Inside Delta diagnostics</p> <p>Access path: [Complete settings] CST → [Motor wiring] MWM T</p> <p>This parameter starts the delta wiring diagnostic, mains supply must be present and no current is injected into the motor. For more information refer to Connection Inside The Delta Of The Motor, page 119.</p> <ul style="list-style-type: none"> • [No] NO: no delta inside wiring diagnostic • [Yes] YES: start delta inside wiring diagnostic <p>This parameter is visible if [Inside Delta] DLT is set to [Yes] YES.</p>		

HMI label	Setting	Factory setting
[In Delta Diag Status] <i>DLTS</i>	–	[Not Done] <i>NA</i>
<p>Inside Delta diagnostics status</p> <p>Access path: [Complete settings] <i>CST</i> → [Motor wiring] <i>MWMT</i></p> <p>This parameter gives the status of the inside delta wiring diagnostic [In Delta Diag] <i>DLTL</i>. For more information refer to Connection Inside The Delta Of The Motor, page 119.</p> <ul style="list-style-type: none"> • [Not Done] <i>NA</i>: diagnostic not done. • [Passed] <i>OK</i>: diagnostic complete • [Pending] <i>PEND</i>: diagnostic pending • [Invert L2 & L3] <i>32</i>: reverse polarity between phase 2 and 3 • [Invert L1 & L2] <i>21</i>: reverse polarity between phase 1 and 2 • [Invert L1 & L3] <i>31</i>: : reverse polarity between phase 1 and 3 • [Change 123 to 312] <i>312</i>: circular permutation, phase 1 on 2, phase 2 on 3, phase 3 on 1 • [Change 123 to 231] <i>231</i>: circular permutation, phase 1 on 3, phase 2 on 1, phase 3 on 2 • [Bad Motor Wiring] <i>MOT</i>: bad motor wiring • [Unknown Error] <i>UNK</i>: unknown error (missing wire, 2 phases on the same motor phase, motor in-line) <p>The corrections proposed by the diagnostic does not ensure that the motor will start in the correct direction. The rotation direction must be checked by applying a Run order without a load on the motor.</p> <p>This parameter is visible if [Inside Delta] <i>DLT</i> is set to [Yes] <i>YES</i>.</p>		
[Small Motor Test] <i>SST</i>	–	[No] <i>NO</i>
<p>Small motor test</p> <p>Access path: [Complete settings] <i>CST</i> → [Motor wiring] <i>MWMT</i></p> <p>This parameter can be used to perform a test using a small motor. For the list of minimum motor rating to follow for this parameter, refer to Small Motor Test, page 117.</p> <ul style="list-style-type: none"> • [Yes] <i>YES</i>: Ready to start the test, apply a Run command • [No] <i>NO</i>: Function inactive, will normally start when a Run command is applied <p>During the test, the display terminal displays the state [Small Motor Test] <i>SST</i>.</p>		
⚠ WARNING		
<p>TEMPORARY MODIFICATION OF THE BEHAVIOR</p> <ul style="list-style-type: none"> • Only use this function for test and maintenance purposes. • Verify that disabling phase loss detection does not result in unsafe conditions. <p>Failure to follow these instructions can result in death, serious injury, or equipment damage.</p>		

3.4 [Preheating] PRF

Access path: [Complete settings] CST → [Preheating] PRF

About this Menu

This menu provides the parameters to preheat the motor before use.

HMI label	Setting	Factory setting
[Preheating Assign] PRHA	–	[Not Assigned] NO

Preheating assignment

Access path: [Complete settings] CST → [Preheating] PRF

Assign a digital input to start the preheating.

- [Not Assigned] NO: preheating start not assigned
- [DI3] LI3: preheating start assigned to digital input DI3
- [DI4] LI4: preheating start assigned to digital input DI4

It is possible to assign this parameter on a virtual input via the CMD word, bits 11 to 15. Refer to the fieldbus manuals for the CMD word assignments.

NOTE: When using the [CD●●] / [C●●●] activation and a communication channel as the active channel, the *Halt* command must be active to remain in the *5 - Operation enabled* state. For further information, please refer to the associated communication manuals.

DANGER

ELECTRIC SHOCK AND/OR UNANTICIPATED EQUIPMENT OPERATION

- Verify that the setting of the parameter [Time Before Preheat] does not result in unsafe conditions.
- When preheating function is used, always consider that the equipment is in the operating state Operation Enabled.

Failure to follow these instructions will result in death or serious injury.

To start the preheating:

- The motor must be stopped
- [Time Before Restart] TBS must be elapsed
- [Time Before Preheat] TPR is elapsed
- Apply and maintain a high level on the STOP terminal
- Apply and maintain a high level on the digital input set to [Preheating Assign] PRHA in step 1

The status [Motor Preheating] HEA is displayed on the display terminal.

To stop the preheating:

- Apply and maintain a low level on the digital or virtual input set to [Preheating Assign] PRHA
- Or apply a Run order
- Or apply a Stop order

For more information about the preheating, refer to Motor Preheating, page 123.

HMI label	Setting	Factory setting
[Preheat Level] IPR	0...100%	0%
<p>Preheating level</p> <p>Access path: [Complete settings] CST → [Preheating] PRF</p> <p>This parameter sets the heating current level. Use a properly rated ammeter to adjust the preheating current level.</p> <p>For more information refer to Motor Preheating, page 123.</p> <p>This parameter is visible only if [Preheating Assign] PRHA is configured.</p> <p>IPR is independent from [Motor Nom Current] IN.</p>		
[Time Before Preheat] TPR	0...999 min	5 min
<p>Time before preheat</p> <p>Access path: [Complete settings] CST → [Preheating] PRF</p> <p>The value set to this parameter starts counting when a Stop order is applied.</p> <p>The soft starter will not preheat the motor as long as [Time Before Preheat] TPR is not elapsed.</p> <p>The status [Motor Preheating] HEA is displayed on the display terminal when the preheating order is applied, even if no current is injected in the motor windings.</p> <p>For more information refer to Motor Preheating, page 123.</p> <p>This parameter is visible only if [Preheating Assign] PRHA is configured.</p>		

3.5 [Start & Stop] SSP

Access path: [Complete settings] CST → [Start & Stop] SSP

About this menu

This menu provides the parameters to manage the ramp-up and ramp-down of the motor.

HMI label	Setting	Factory setting
[Control Mode] CLP	[Torque Control] TC or [Voltage Control] VC	[Torque Control] TC
<p>Control mode</p> <p>This parameter sets the motor control algorithm.</p> <p>For more information refer to Torque / Voltage Control, page 128.</p> <ul style="list-style-type: none"> • [Torque Control] TC: enable torque control • [Voltage Control] VC: enable voltage control 		
[Acceleration] ACC	1...60 s	15 s
<p>Acceleration ramp time</p> <ul style="list-style-type: none"> • When [Control Mode] CLP is set to [Torque Control] TC (factory setting), this parameter sets the ramp time from no torque to nominal torque. When the motor reaches established regime, the soft starter state change to [Running] RUN or [Bypassed] BYP, even if the motor reaches established regime before the value set to [Acceleration] ACC. The initial starting torque depends on the parameter [Init Starting Torque] TQ0. • When [Control Mode] CLP is set to [Voltage Control] VC, the value set to this parameter is the time of the voltage ramp from the initial voltage to the established mains voltage, if the parameter [Motor Nom Current] IN doesn't limit the starting current. The initial voltage of the ramp is set by the parameters [Boost] BST and [Init Starting Voltage] V0. <p>For more information refer to Torque / Voltage Control, page 128.</p> <p>For more information about [Boost], refer to Voltage Boost, page 129.</p>		
[Init Starting Torque] TQ0	0...100% of nominal torque	20%
<p>Initial starting torque</p> <p>Initial torque setting during the starting phase, varies from 0 to 100% of the nominal torque. If set too low, the motor may not start as soon as the RUN command is applied.</p> <p>For more information refer to Set Start Profile, page 112.</p>		

HMI label	Setting	Factory setting
[Boost] <i>BST</i>	50...100% of the nominal motor voltage or [No] <i>NO</i>	[No] <i>NO</i>
<p>Voltage boost level</p> <p>This parameter provides a boost at the start to overcome a mechanical hard point.</p> <p>For more information refer to Voltage Boost, page 129.</p> <ul style="list-style-type: none"> [No] <i>NO</i>: Function inactive 50...100%: setting as a % of mains voltage during boost. <p>NOTE: Setting the value of this parameter too high can cause an overcurrent and triggers the [Overcurrent] <i>OCF</i> error.</p>		
[Init Starting Voltage] <i>VO</i>	25%...49% of [Mains Voltage] <i>ULN</i>	49%
<p>Initial starting voltage</p> <p>Set [Init Starting Voltage] <i>VO</i> level between 25% and 49% of [Mains Voltage] <i>ULN</i>. The set value must be high enough to create a torque superior to the resistive torque.</p> <p>For more information refer to Voltage Boost, page 129.</p> <p>This parameter can be accessed if:</p> <ul style="list-style-type: none"> [Control Mode] <i>CLP</i> is set to [Voltage Control] <i>VC</i> [Boost] <i>BST</i> is set to [No] <i>NO</i>. 		
[Type of stop] <i>STT</i>	–	[Freewheel] <i>F</i>
<p>Type of stop</p> <p>This parameter sets the type of stop when a Stop command is applied.</p> <p>For more information refer to Set Stop Profile, page 113.</p> <ul style="list-style-type: none"> [Freewheel] <i>F</i>: Freewheel stop. [Deceleration] <i>D</i>: Soft stopping by control of torque if [Control Mode] <i>CLP</i> is set to [Torque Control] <i>TC</i> (factory setting), by voltage ramp if [Control Mode] <i>CLP</i> is set to [Voltage Control] <i>VC</i>. [Braking] <i>B</i>: Dynamic braking stop. 		
[Freewheel Assign] <i>FFSA</i>	–	[DI3] <i>LI3</i>
<p>Freewheel stop assignment</p> <p>This parameter is used to force a freewheel stop at the next Stop command.</p> <ul style="list-style-type: none"> [DI3] <i>LI3</i>: Assign DI3 to forced freewheel stop at the next Stop command. [DI4] <i>LI4</i>: Assign DI4 to forced freewheel stop at the next Stop command. [Not Assigned] <i>NO</i>: No digital input assigned. <p>[Freewheel Assign] <i>FFSA</i> is forced to [Not Assigned] <i>NO</i> when [Cascade] <i>CSC</i> is set to [ON] <i>ON</i>.</p>		

HMI label	Setting	Factory setting
[Deceleration] DEC	1...60 s	15 s

Deceleration ramp time

If [Control Mode] CLP is set to [Torque Control] TC (factory setting), this parameter sets the deceleration ramp from the estimated applied torque at Stop order to no torque applied.

Example with 80% of the nominal torque when a Stop order is applied:

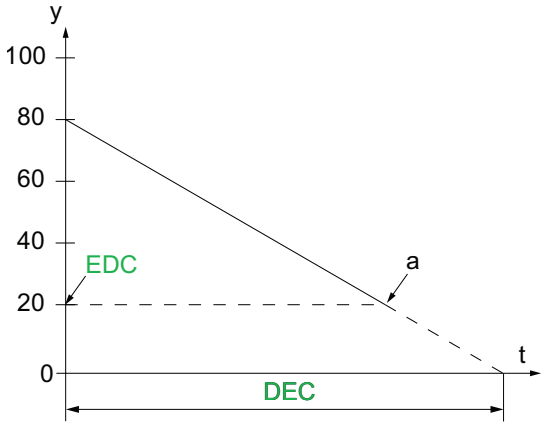

- y: Estimated torque (as a percentage of the nominal torque).
- a: End of controlled deceleration set by EDC, motor stop in freewheel
- t: Time (s)

Depending on the load characteristics, it is possible the motor may not stop to a standstill at the end of the ramp.

If [Control Mode] CLP is set to [Voltage Control] VC, this parameter sets the ramp down of the voltage applied to the motor, from 100% to 50% of the mains supply. Below 50%, the voltage applied drop to 0% and the motor stops in freewheel.

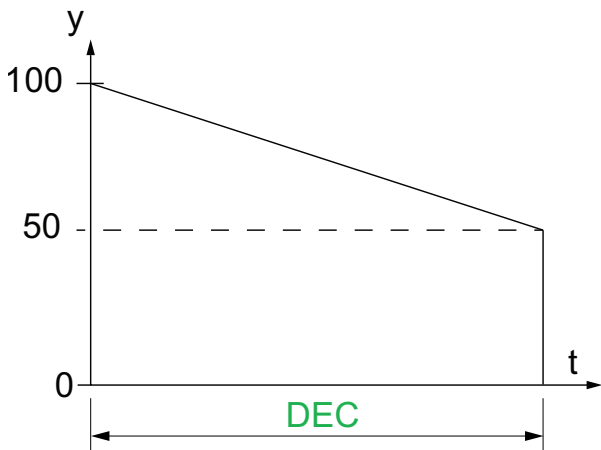

- y: Applied mains voltage as % of the mains voltage
- t: Time (s)

Depending on the load characteristics, it is possible the motor may not stop to a standstill at the end of the ramp.

This parameter can only be accessed if [Type of stop] STT is set to [Deceleration] D.

For more information about [Control Mode] CLP, refer to Torque / Voltage Control, page 128.

HMI label	Setting	Factory setting
[End Of Deceleration] EDC	0...100% of estimated torque when a Stop order is applied	20%
<p><i>End of controled deceleration threshold</i></p> <p>As soon as the estimated torque is below the value set in [End Of Deceleration] EDC, the motor stops in freewheel.</p> <p>For more information refer to Set Stop Profile, page 113.</p> <p>This parameter can be accessed if:</p> <ul style="list-style-type: none"> • [Type of stop] STT is set to [Deceleration] D • [Control Mode] CLP in [Complete settings] CST menu is set to [Torque Control] TC (factory setting) 		

HMI label	Setting	Factory setting
[Braking Level] BRC	0...100%	50%

Dynamic braking level

This parameter can only be accessed if [Type of stop] STT is set to [Braking] B.

Braking is active according to the ramp set in [Braking Level] BRC. The total stopping duration of the motor is configured by adjusting the injection time of the pseudo-continuous current in the motor applied on two phases. See next parameter [DC Braking Time] EBA.

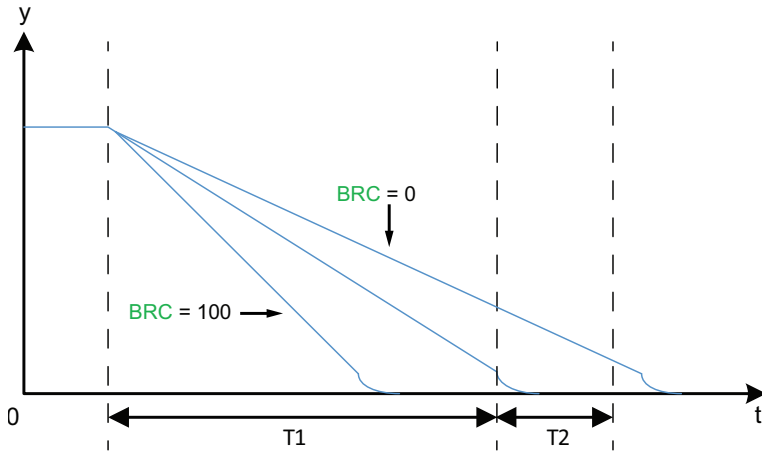

- y: Nominal speed
- t: Time (s)
- T1: Dynamic braking time, ramp set by [Braking Level] BRC
- T2: Adjustment of motor stop by [DC Braking Time] EBA

Pseudo-continuous injection time: $T2 = T1 \times$ [DC Braking Time] EBA.

Note: Time T1 is dependant of [Braking Level] BRC. The higher the value, the stronger is the braking and the faster is the ramp.

This parameter can only be accessed if [Type of stop] STT is set to [Braking] B.

NOTICE

MECHANICAL STRESS

- Do not set a high value of [Braking Level] BRC if your application have a high inertia.
- Verify that this value is suitable by performing a commissioning test under maximum load conditions.

Failure to follow these instructions can result in equipment damage.

For more information refer to Set Stop Profile, page 113.

This parameter can be accessed if [Type of stop] STT is set to [Braking] B.

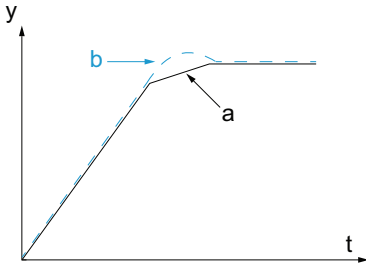
HMI label	Setting	Factory setting
[DC Braking Time] EBA	20...100%	20%
<p>DC continuous braking time</p> <p>This parameter adjusts the current injection time at the end of braking.</p> <p>Example:</p> <p>Dynamic braking = 10 s (T1) [DC Braking Time] EBA = 20% corresponds to an injection time of 2 s [DC Braking Time] EBA = 100% corresponds to an injection time of 10 s</p> <p>For more information refer to Set Stop Profile, page 113.</p> <p>This parameter can be accessed if [Type of stop] STT is set to [Braking] B.</p>		
[Deceleration Gain] TIG	10...50 %	40 %
<p>Torque control deceleration gain</p> <p>In case of instability when decelerating, [Deceleration Gain] TIG value can be gradually reduced.</p> <p>This parameter can be accessed if:</p> <ul style="list-style-type: none"> [Control Mode] CLP is set to [Torque Control] TC [Type of stop] STT is set to [Deceleration] D 		
[Torque Limit] TLI 	10...200% or [No] NO	[No] NO
<p>Torque limit</p> <p>This parameter:</p> <ul style="list-style-type: none"> Set the final torque of the torque-controlled acceleration when [Control Mode] CLP is set to [Torque Control] TC Limit the torque reference to avoid regenerative behavior in applications with high inertia Can be used for constant starting torque if [Init Starting Torque] TQ0 = [Torque Limit] TLI and if the application load is compliant. <p>Possible values are:</p> <ul style="list-style-type: none"> 10...200 % : Limit torque reference [No] NO: inactive <div style="display: flex; align-items: flex-start;"> <div style="flex: 1;">  </div> <div style="flex: 1; margin-left: 20px;"> <ul style="list-style-type: none"> y: Motor speed t: Time (s) a: No generative mode with appropriate TLI b: Generative mode without appropriate TLI </div> </div> <p>This parameter can be accessed if [Control Mode] CLP is set to [Torque Control] TC.</p>		

HMI label	Setting	Factory setting
[Stator Loss Comp]  LSC	0...90 %	50 %
<p>Stator loss compensation</p> <p>In the event of torque oscillations, reduce this parameter gradually until the motor is properly operating. Oscillations are most common if the soft starter is connected in the motor delta winding or with motors with excessive slip.</p> <p>This parameter is active during acceleration phases and deceleration phases if [Type of stop] STT is set to [Deceleration] D.</p> <p>When [Inside Delta] DLT is set to [Yes] YES, [Stator Loss Comp] LSC is set to its new factory setting 30%.</p> <p>This parameter is effective only if [Control Mode] CLP is set to [Torque Control] TC.</p>		

3.6 [Cascade] CSC

Access path: [Complete settings] CST → [Cascade] CSC

About this Menu

This menu provides the parameters to set the cascade function. For more information about the cascade function refer to Cascade Motors, page 134.

HMI label	Setting	Factory setting
[Cascade] CSC	[Yes] YES or [No] NO	[OFF] OFF
<p>Cascade function activation</p> <p>Access path: [Complete settings] CST → [Cascade] CSC</p> <p>This parameter enables the start of several motors in sequence with the same soft starter.</p> <p>For more information refer to Cascade Motors, page 134.</p> <ul style="list-style-type: none"> • [Yes] YES: enables cascade function • [No] NO: disables cascade function <p>This parameter requires:</p> <ul style="list-style-type: none"> • [Inside Delta] DLT is set to [No] NO • No digital input set to [Preheating Assign] PRHA • No digital input set to [Freewheel Assign] FFSA • [R1 Assignment] R1 set to [Isolating Relay] ISOL • [Cmd channel 1] CD1 is set to [Terminal] TER and [Command Switching] CCS set to [Cmd channel 1] CD1 • [HMI L/R cmd] BMP set to [Disabled] DIS and [Forced Local Chan] FLOC set to [Terminal] TER. 		
 DANGER		
<p>HAZARD OF ELECTRIC SHOCK, EXPLOSION OR ARC FLASH</p> <p>If cascade function is enabled, monitoring functions such as output phase loss detection are not effective for the motors that are started and bypassed. Phase loss and, by implication, accidental disconnection of cables, are not detected.</p> <ul style="list-style-type: none"> • Verify that the absence of phase loss monitoring does not result in unsafe conditions or install external monitoring device to detect phase loss on each motor. <p>Failure to follow these instructions will result in death or serious injury.</p>		
<p>When the cascade function is enabled, thermal monitoring of the motor is disabled.</p>		
<p>NOTICE</p>		
<p>MOTOR OVERHEATING</p> <ul style="list-style-type: none"> • Install external thermal monitoring equipment for each motor used in the cascade sequence. <p>Failure to follow these instructions can result in equipment damage.</p>		

HMI label	Setting	Factory setting
[Cascade DI Assign] CSCA	–	[Not Assigned] NO
<p>Cascade DI assignment</p> <p>Access path: [Complete settings] CST → [Cascade] CSC</p> <p>This parameter assigns a digital input to start the cascade sequence.</p> <p>For more information refer to Cascade Motors, page 134.</p> <ul style="list-style-type: none"> • [Not Assigned] NO: cascade function start not assigned • [DI3] LI3: cascade function assigned to digital input DI3 • [DI4] LI4: cascade function start assigned to digital input DI4 		

3.7 [Smoke Extraction] SMOE

Access path: [Complete settings] CST → [Smoke Extraction] SMOE

About this Menu

This menu provides the parameter to set an emergency start and inhibit error detection.

In rare cases, the monitoring functions of the device may be unwanted because they impede the purpose of the application. A typical example is a smoke extractor fan operating as a part of a fire protection system. If a fire occurs, the smoke extractor fan should operate as long as possible, even if, for example, the permissible ambient temperature of the device is exceeded. In such applications, damage to or destruction of the device may be acceptable as collateral damage, for example, to keep other damage from occurring whose hazard potential is assessed to be more severe.

A parameter is provided to disable certain monitoring functions in such applications so that automatic error detection and automatic error responses of the device are no longer active. You must implement alternative monitoring functions for disabled monitoring functions that allow operators and/or master control systems to adequately respond to conditions which correspond to detected errors. For example, if overtemperature monitoring of the device is disabled, the device of a smoke extractor fan may itself cause a fire if errors go undetected. An overtemperature condition can be, for example, signaled in a control room without the device being stopped immediately and automatically by its internal monitoring functions.

⚠ DANGER

MONITORING FUNCTIONS DISABLED, NO ERROR DETECTION

- Only use this parameter after a thorough risk assessment in compliance with all regulations and standards that apply to the device and to the application.
- Implement alternative monitoring functions for disabled monitoring functions that do not trigger automatic error responses of the device, but allow for adequate, equivalent responses by other means in compliance with all applicable regulations and standards as well as the risk assessment.
- Commission and test the system with the monitoring functions enabled.
- During commissioning, verify that the device and the system operate as intended by performing tests and simulations in a controlled environment under controlled conditions.

Failure to follow these instructions will result in death or serious injury.

HMI label	Setting	Factory setting
[Disable Error Detect] INH	–	[Not Assigned] NO
<p>Disable error detection</p> <p>Access path: [Complete settings] CST → [Smoke Extraction] SMOE</p> <p>Assign a digital input to inhibit error detection. The soft starter registers the detected errors but does not stop running. Apply a high level to the assigned input to inhibit the error detection.</p> <ul style="list-style-type: none"> • [Not Assigned] NO: Error inhibition not assigned • [DI3] LI3: Error inhibition assigned to digital input DI3 • [DI4] LI4: Error inhibition assigned to digital input DI4 <p>It is possible to assign this parameter on a virtual input via the CMD word, bits 11 to 15. Refer to the fieldbus manuals for the CMD word assignments.</p> <p>For more information refer to Smoke Extraction, page 136.</p>		



3.8 [Command channel] CCP



Access path: [Complete settings] CST → [Command channel] CCP

About this Menu

This menu provides the parameters to set the command channels, switch between the set channels and force local control of the soft starter.

HMI label	Setting	Factory setting
[Control Mode] CHCF	–	[SE8 Profile] SE8
<p>Control mode configuration</p> <p>Access path: [Complete settings] CST → [Command channel] CCP</p> <p>This parameter is relevant if the soft starter is used with a fieldbus.</p> <ul style="list-style-type: none"> Set [Control Mode] CHCF to [SE8 Profile] SE8 to substitute the ATS48 fieldbus architecture. This setting enables the reuse of the same gateways, parameter mapping, command words and status words as ATS48. Available only in Modbus RTU. Set [Control Mode] CHCF to [Standard Profile] STD to use the latest evolutions of the embedded Modbus and the fieldbus modules. The [Standard Profile] STD is based on CIA402. <p>Plugging or unplugging a fieldbus module does not automatically change the value set in [Control Mode] CHCF. Set manually [Control Mode] CHCF to [Standard Profile] STD to use a fieldbus module.</p> <p>The [Config Change] CFE2 triggers if a fieldbus module is plugged while [Control Mode] CHCF is set to [SE8 Profile] SE8.</p>		
[Command Switching] CCS 	–	[Cmd channel 1] CD1
<p>Command switching</p> <p>Access path: [Complete settings] CST → [Command channel] CCP</p> <div style="border: 1px solid black; padding: 10px; text-align: center;"> <p>⚠ WARNING</p> <p>UNANTICIPATED EQUIPMENT OPERATION</p> <p>This parameter can cause unintended movements, for example, inversion of the direction of rotation of the motor, sudden acceleration or stops.</p> <ul style="list-style-type: none"> Verify that the setting of this parameter does not cause unintended movements. Verify that the setting of this parameter does not result in unsafe conditions. <p>Failure to follow these instructions can result in death, serious injury, or equipment damage.</p> </div> <p>This parameter sets which channel takes the command of the soft starter.</p> <ul style="list-style-type: none"> [Cmd channel 1] CD1: Channel 1 is the command channel [Cmd channel 2] CD2: Channel 2 is the command channel [DI3] LI3: Command channel switching assigned to digital input DI3, this setting assign also [DI3 assignment] L3A to [Cmd switching] LICCS [DI4] LI4: Command channel switching assigned to digital input DI4, this setting assign also [DI4 assignment] L4A to [Cmd switching] LICCS 		

HMI label	Setting	Factory setting
<p>When assigned to a digital input:</p> <ul style="list-style-type: none"> • [Cmd channel 1] CD1 active at low level • [Cmd channel 2] CD2 active at high level <p>It is possible to assign this parameter on a virtual input via the CMD word, bits 11 to 15. Refer to the fieldbus manuals for the CMD word assignments.</p> <p>This parameter can be accessed if [Control Mode] CHCF is set to [Standard Profile] STD</p>		
[Cmd channel 1] CD1	–	[Terminal] TER
<p>Command channel 1 assign</p> <p>Access path: [Complete settings] CST → [Command channel] CCP</p> <p>This parameter sets the active control channel for [Cmd channel 1] CD1.</p> <ul style="list-style-type: none"> • [Terminal] TER: command with the digital inputs • [HMI] LCC: command with the display terminal • [Embd Mdb] MDB: command with the embedded Modbus • [Com. Module] NET: command with the plugged fieldbus module <p>This parameter can be accessed if [Control Mode] CHCF is set to [Standard Profile] STD</p>		
[Cmd channel 2] CD2 	–	[Embd Mdb] MDB
<p>Command channel 2 assign</p> <p>Access path: [Complete settings] CST → [Command channel] CCP</p> <p>This parameter sets the active control channel for [Cmd channel 2] CD2.</p> <ul style="list-style-type: none"> • [Terminal] TER: command with the digital inputs • [HMI] LCC: command with the display terminal • [Embd Mdb] MDB: command with the embedded Modbus • [Com. Module] NET: command with the plugged fieldbus module <p>This parameter can be accessed if [Control Mode] CHCF is set to [Standard Profile] STD</p>		
[Copy Ch1-Ch2] COP 	–	[No] NO
<p>Copy Ch.1-Ch.2</p> <p>Access path: [Complete settings] CST → [Command channel] CCP</p> <p>This parameter copies the channel command configuration.</p> <ul style="list-style-type: none"> • [No] NO: No copy • [Command] CD: Copy the command words from channel 1 to channel 2 <p>NOTE: A command cannot be copied from a channel on terminals.</p>		
▲ WARNING		
<p>UNANTICIPATED EQUIPMENT OPERATION</p> <p>This parameter can cause unintended movements, for example, inversion of the direction of rotation of the motor, sudden acceleration or stops.</p> <ul style="list-style-type: none"> • Verify that the setting of this parameter does not cause unintended movements. • Verify that the setting of this parameter does not result in unsafe conditions. <p>Failure to follow these instructions can result in death, serious injury, or equipment damage.</p>		
<p>This parameter is visible only if [Control Mode] CHCF is set to [Standard Profile] STD.</p>		

HMI label	Setting	Factory setting
[Forced Local Assign]  FLO	–	[DI4] LI4
<p>Forced local assignment</p> <p>Access path: [Complete settings] CST → [Command channel] CCP</p> <p>This parameter forces the local channel set by [Forced Local Chan] FLOC.</p> <p>[Forced Local Assign] FLO is active when a high level is applied to the set digital input.</p> <p>When the forced local channel is activated, the soft starter is stopped following the type of stop set by [Type of stop] STT if a Run command is not active on the forced channel.</p> <ul style="list-style-type: none"> • [No] NO: No digital input set • [DI3] LI3: Forced local assignment set to digital input DI3 on high level, this setting assign also [DI3 assignment] L3A to [Forced Local] LIFLO • [DI4] LI4: Forced local assignment set to digital input DI4 on high level, this setting assign also [DI4 assignment] L4A to [Forced Local] LIFLO <p>The assigned digital input is set to [Forced Local] LIFLO.</p>		
[Forced Local Chan]  FLOC	–	[Terminal] TER
<p>Forced Local channel assignment</p> <p>Access path: [Complete settings] CST → [Command channel] CCP</p> <p>This parameter set which local channel is forced at the activation of the digital input set in [Forced Local Chan] FLOC.</p> <ul style="list-style-type: none"> • [Terminal] TER: Forced local channel are the digital inputs • [HMI] LCC: Forced local channel is forced the display terminal <p>This parameter is visible only if</p> <ul style="list-style-type: none"> • [Control Mode] CHCF is set to [Standard Profile] STD • [Forced Local Assign] FLO is configured 		
[Time-out forc. local]  FLOT	0.1...30 s	10 s
<p>Time-out forc. local</p> <p>Access path: [Complete settings] CST → [Command channel] CCP</p> <p>Timeout to confirm a new channel command after forced local deactivation.</p> <p>This parameter is visible only if:</p> <ul style="list-style-type: none"> • FLO is configured • [Control Mode] CHCF is set to [Standard Profile] STD 		

3.9 [Error/Warn handling] CSWM

Access path: [Complete settings] CST → [Error/Warn handling] CSWM

About this Menu

This menu provides the parameters to manage the errors and warnings handling.

[External error] ETF –

HMI label	Setting	Factory setting
[Ext Error assign] ETF	–	[Not Assigned] NO
<p>External error assignment</p> <p>Access path: [Complete settings] CST → [Error/Warn handling] CSWM → [External error] ETF</p> <p>This parameter assigns the detection of the [External Error] EPF1 error to DI3, DI4 or a virtual input.</p> <p>The level of detection on the assigned input is set by [Ext Error Condition] LET.</p> <ul style="list-style-type: none"> [Not Assigned] NO: External error not assigned [DI3] LI3: External error assigned to digital input DI3, this setting assign also [DI3 assignment] L3A to [External Error] LIETF [DI4] LI4: External error assigned to digital input DI4, this setting assign also [DI4 assignment] L4A to [External Error] LIETF <p>It is possible to assign this parameter on a virtual input via the CMD word, bits 11 to 15. Refer to the fieldbus manuals for the CMD word assignments.</p>		
[Ext Error Condition] LET	–	[High Level] HIGH
<p>External error condition</p> <p>Access path: [Complete settings] CST → [Error/Warn handling] CSWM → [External error] ETF</p> <p>This parameter sets at which level the detection of [External Error] EPF1 occurs on the assigned digital input.</p> <ul style="list-style-type: none"> [High Level] HIGH: External error detected at high level [Low Level] LOW: External error detected at low level <p>When [Ext Error Condition] LET is set to [High Level] HIGH, accidental disconnection of the cable connected to the digital input assigned to [Ext Error assign] ETF is not detected.</p>		
<h2>⚠ WARNING</h2>		
<p>LOSS OF CONTROL</p> <ul style="list-style-type: none"> Verify that the setting of this parameter does not result in unsafe conditions Set this parameter to [Low Level] LOW if you want to detect accidental disconnection of the cable connected to the digital input assigned to [Ext Error assign] ETF <p>Failure to follow these instructions can result in death, serious injury, or equipment damage.</p>		

HMI label	Setting	Factory setting
[Auto Fault Reset] <i>ATR</i>	–	[No] <i>NO</i>
<p>Automatic fault reset</p> <p>Access path: [Complete settings] <i>CST</i> → [Error/Warn handling] <i>CSWM</i></p> <p>This parameter enables the automatic reset of the soft starter after the triggered error has been cleared. For more information refer to Troubleshooting, page 249.</p> <ul style="list-style-type: none"> [No] <i>NO</i>: disables automatic reset [Yes] <i>YES</i>: allows automatic reset <p>This function can be used to automatically perform individual or multiple Fault Resets. If the cause of the error that has triggered the transition to the operating state Fault disappears while this function is active, the device resumes normal operation. While the Fault Reset attempts are performed automatically, the output signal "Operating state Fault" is not available. If the attempts to perform the Fault Reset are not successful, the device remains in the operating state Fault and the output signal "Operating state Fault" becomes active.</p>		
<p>⚠ WARNING</p>		
<p>UNANTICIPATED EQUIPMENT OPERATION</p> <ul style="list-style-type: none"> Verify that activating this function does not result in unsafe conditions. Verify that the fact that the output signal "Operating state Fault" is not available while this function is active does not result in unsafe conditions. <p>Failure to follow these instructions can result in death, serious injury, or equipment damage.</p>		
<p>The relay R1 remains closed if this function is active as long as [Fault Reset Time] <i>TAR</i> is not elapsed. The Run command must be maintained.</p> <p>It is recommended to use 2–wire control to be able to perform an automatic restart of the motor after an automatic reset of the device. In 3–wire control the motor will not automatically restart.</p>		
[Fault Reset Time] <i>TAR</i>	–	[5 minutes] <i>5</i>
<p>Fault Reset time</p> <p>Access path: [Complete settings] <i>CST</i> → [Error/Warn handling] <i>CSWM</i></p> <p>This parameter sets the maximum time for a successful automatic reset. An automatic reset is attempted every 60 seconds. If [Fault Reset Time] <i>TAR</i> is elapsed before a successful automatic reset, the soft starter can only be reset with a manual reset. For more information refer to Troubleshooting, page 249.</p> <ul style="list-style-type: none"> [5 minutes] <i>5</i>: 5 minutes for successful automatic restart [10 minutes] <i>10</i>: 10 minutes for successful automatic restart [30 minutes] <i>30</i>: 30 minutes for successful automatic restart [1 hour] <i>1H</i>: 1 hour for successful automatic restart [2 hours] <i>2H</i>: 2 hours for successful automatic restart [3 hours] <i>3H</i>: 3 hours for successful automatic restart [Unlimited] <i>CT</i>: Unlimited time for successful automatic restart <p>This parameter can be accessed if [Auto Fault Reset] <i>ATR</i> is set to [Yes] <i>YES</i>.</p>		

HMI label	Setting	Factory setting
[Disable Error Detect] <small>INH</small>	–	[Not Assigned] <small>NO</small>
<p>Disable error detection</p> <p>Access path: [Complete settings] CST → [Error/Warn handling] CSWM</p> <p>Assign a digital or virtual input to inhibit error detection. The soft starter records the detected errors without triggering in the operating state Fault.</p> <ul style="list-style-type: none"> • [Not Assigned] <small>NO</small>: Error inhibition not assigned • [DI3] <small>LI3</small>: Error inhibition assigned to digital input DI3, this setting assigns also [DI3 assignment] <small>L3A</small> to [Disable Error Detect] <small>LIINH</small> • [DI4] <small>LI4</small>: Error inhibition assigned to digital input DI4, this setting assigns also [DI4 assignment] <small>L4A</small> to [Disable Error Detect] <small>LIINH</small> <p>It is possible to assign this parameter on a virtual input via the CMD word, bits 11 to 15. Refer to the fieldbus manuals for the CMD word assignments.</p> <p>For more information refer to Smoke Extraction, page 136.</p> <p>In rare cases, the monitoring functions of the soft starter may be unwanted because they impede the purpose of the application. A typical example is a smoke extractor fan operating as part of a fire protection system. If a fire occurs, the smoke extractor fan should operate as long as possible, even if, for example, the permissible ambient temperature of the soft starter is exceeded. In such applications, damage to or destruction of the device may be acceptable as collateral damage, for example, to keep other damage from occurring whose hazard potential is assessed to be more severe.</p> <p>A setting for the digital inputs is provided to disable certain monitoring functions in such applications so that automatic error detection and automatic error responses of the device are no longer active. You must implement alternative monitoring functions for disabled monitoring functions that allow operators and/or master control systems to adequately respond to conditions which correspond to detected errors. For example, if overtemperature monitoring of the soft starter is disabled, the soft starter of a smoke extractor fan may itself cause a fire if errors go undetected. An overtemperature condition can be, for example, signalled in a control room without the soft starter being stopped immediately and automatically by its internal monitoring functions.</p>		
⚠ DANGER		
MONITORING FUNCTIONS DISABLED, NO ERROR DETECTION		
<ul style="list-style-type: none"> • Only set the digital inputs to [Error detect disabling] after a thorough risk assessment in compliance with all regulations and standards that apply to the device and to the application. • Implement alternative monitoring functions for disabled monitoring functions that do not trigger automatic error responses of the soft starter but allow for adequate, equivalent responses by other means in compliance with all applicable regulations and standards as well as the risk assessment. • Commission and test the system with the monitoring functions enabled. • During commissioning, verify that the soft starter and the system operate as intended by performing tests and simulations in a controlled environment under controlled conditions. <p>Failure to follow these instructions will result in death or serious injury.</p>		

HMI label	Setting	Factory setting
[Product restart] RP	–	[Not Assigned] NO
<p>Product restart</p> <p>Access path: [Complete settings] CST → [Error/Warn handling] CSWM</p> <p>Manually restart the device via the HMI. Press and hold the OK button on the display terminal for 2 seconds to restart the device.</p> <p>This parameter is automatically set to [Not Assigned] NO after restart.</p> <ul style="list-style-type: none"> • [Not Assigned] NO: No restart • [Yes] YES: Restart the soft starter <p>The Restart function performs a Fault Reset and then restarts the device. During this Restart procedure, the device goes through the same steps as if it had been switched off and on again. Depending on the wiring and the configuration of the device, this may result in immediate and unanticipated operation.</p> <div style="border: 1px solid black; padding: 5px; text-align: center;"> <p>⚠ WARNING</p> <p>UNANTICIPATED EQUIPMENT OPERATION</p> <p>The Restart function performs a Fault Reset and restarts the device.</p> <ul style="list-style-type: none"> • Verify that activating this function does not result in unsafe conditions. <p>Failure to follow these instructions can result in death, serious injury, or equipment damage.</p> </div>		

[Fault reset] RST –

HMI label	Setting	Factory setting
[Fault Reset Assign] RSF	–	[Not Assigned] NO
<p>Fault reset input assignment</p> <p>Access path: [Complete settings] CST → [Error/Warn handling] CSWM → [Fault reset] RST</p> <p>This parameter sets the digital input for a manual reset on rising edge.</p> <p>If no digital input is set, a manual reset is possible by applying a Run order.</p> <p>This parameter does not reset the [Motor Overload] OLF error.</p> <ul style="list-style-type: none"> • [Not Assigned] NO: Manual reset not assigned • [DI3] LI3: Manual reset assigned to digital input DI3 • [DI4] LI4: Manual reset assigned to digital input DI4 		
[Th Error Reset Assign] RSFT	–	[Not Assigned] NO
<p>Thermal error reset assignment</p> <p>Access path: [Complete settings] CST → [Error/Warn handling] CSWM → [Fault reset] RST</p> <p>This parameter sets the digital input for a thermal reset on rising edge.</p> <p>If no digital input is set, a manual reset is possible:</p> <ul style="list-style-type: none"> • Via [Fault Reset Assign] RSF if this parameter is configured • Or by applying a new Run order <p>by applying a Run command.</p> <p>This parameter reset the [Motor Overload] OLF error on rising edge.</p> <ul style="list-style-type: none"> • [Not Assigned] NO: Manual reset for [Motor Overload] OLF not assigned • [DI3] LI3: Manual reset for [Motor Overload] OLF assigned to digital input DI3 • [DI4] LI4: Manual reset for [Motor Overload] OLF assigned to digital input DI4 		

HMI label	Setting	Factory setting
[Control Supply Loss] CLB	–	[Error] 0
<p>Response to control supply loss</p> <p>Access path: [Complete settings] CST → [Error/Warn handling] CSWM</p> <p>This parameter sets the soft starter behavior when the control supply on CL1 and CL2 is out of range.</p> <ul style="list-style-type: none"> • [Error] 0: Triggers the [Control Supply Error] CLF error. Opens the relay R1 if it is assigned to [Operating State Fault] FLT and if [Auto Fault Reset] ATR is set to [No] NO. • [Error w/o Relay] 1: Triggers the [Control Supply Error] CLF error and keeps the relay assigned to [Operating State Fault] FLT closed • [Warning] 2: triggers the [Ctrl Supply Loss] CLA warning instead of triggering [Control Supply Error] CLF. <p>NOTE: The [Ctrl Supply Loss] CLA warning will trigger only if:</p> <ul style="list-style-type: none"> • If is added to a warning group definition in [Diagnostics] DIA → [Warnings] ALR • The soft starter loses the control supply on CL1 / CL2 while not in operating state [Running] RUN. Otherwise the [Control Supply Error] CLF will trigger instead. 		

[Warn groups config] [AGCF](#) –

Access path: [Complete settings] [CST](#) → [Warn groups config] [AGCF](#)

This sub-menu sets the configuration of the following warning groups:

- **[Warn grp 1 definition]** [A1C](#)
- **[Warn grp 2 definition]** [A2C](#)
- **[Warn grp 3 definition]** [A3C](#)
- **[Warn grp 4 definition]** [A4C](#)
- **[Warn grp 5 definition]** [A5C](#)

When a warning is triggered, the relay or digital input set to the triggered warning group is activated.

NOTE:

Any triggered warning that is not assigned to a warning group will not be visible on the display terminal, will not be signaled by the LEDs of the soft starter and will not be logged.

By default the following warnings are assigned to a warning group:

- **[No Battery Warn]** [RBNA](#)
- **[Low Battery Warn]** [RBLA](#)
- **[Invalid RTC Warn]** [RTCA](#)

4 [Input/Output] IO

What's in This Chapter

4.1 [DI3 assignment] L3A	4.2 [DI4 assignment] L4A	184
4.3 [DQ1 configuration] DO1		185
4.4 [DQ2 Configuration] DO2		186
4.5 [AI1 configuration] AI1		187
4.6 [AQ1 configuration] AO1		188
4.7 [R1 configuration] R1		191
4.9 [R3 configuration] R3		192

About the menu [Input/Output] IO

This menu manages the assignments of the digital inputs, digital outputs, analogic inputs, analogic outputs and relays.

Digital inputs DI3 and DI4 assignments are active when a high level is applied, unless exceptions that are explicitly notified.

[Input/Output] IO menu navigation

4.1 [DI3 assignment] L3A
4.2 [DI4 assignment] L4A
4.3 [DQ1 configuration] DO1
[DQ1 Assignment] DO1
[DQ1 Active at] DO1S
4.4 [DQ2 Configuration] DO2
[DQ2 Assign] DO2
[DQ2 Active at] DO2S
4.5 [AI1 configuration] AI1
[AI1 assignment] AI1A
[AI1 Type] AI1T
[AI1 filter] AI1F

4.6 [AQ1 configuration] AO1
[AQ1 assignment] AO1
[AQ1 Scaling] AO1S
[AQ1 Type] AO1T
[AQ1 min output] AOL1
[AQ1 max output] AOH1
[AQ1 min Output] UOL1
[AQ1 max Output] UOH1
[Scaling AQ1 Min] ASL1
[Scaling AQ1 Max] ASH1
[AQ1 Filter] AO1F

4.7 [R1 Configuration] R1
[R1 Assignment] R1
4.9 [R3 configuration] R3
[R3 Assignment] R3
[R3 Active at] R3S
[R3 Holding time] R3H

4.1 [DI3 assignment] L3A

4.2 [DI4 assignment] L4A

Those parameters provide the possible assignment to the digital inputs DI3 and DI4.

Description	Setting range	Factory setting
[DI3 assignment] L3A [DI4 assignment] L4A	–	[Freewheel Stop] FFSA [Forced Local] LIFLO
<p>DI3 assignment DI4 assignment</p> <p>Access path: [Input/Output] IO</p> <p>Those parameters assign a function to the digital inputs DI3 and DI4.</p> <p>Only one function can be assigned to [DI3 assignment] L3A or [DI4 assignment] L4A at any moment. If you assign a new function to an already assigned digital input, the previous function assigned to this digital input will be deactivated.</p> <p>Unless specified otherwise, the following assignments are active are active when a high level if applied.</p> <ul style="list-style-type: none"> • [No] NO: Digital input not assigned • [Fault Reset] LIRSF: Resets the device to clear a detected error after removing its cause. • [External Error] LIETF: Allows the device to trigger an external user error (level, pressure, ...). The external error can trigger on a high or low level, set by [Ext Error Condition] LET. Automatic assignment: [Ext Error assign] ETF set to digital input. • [Cmd switching] LICCS: Sets the active command channel ([Cmd channel 1] CD1 active at low level or [Cmd channel 2] CD2 active at high level). This function can be assigned only via the parameter [Command Switching] CCS in the menu [Complete settings] CST → [Command channel] CCP. This function cannot be assigned via the menu [Input/Output] IO. If [Command Switching] CCS is assigned to a digital input, it is necessary to remove first this assignment via the parameter before assigning the digital input to a new function. • [Forced Local] LIFLO: Forces the local channel set by [Forced Local Chan] FLOC. Automatic assignment: [Forced Local Assign] FLO set to digital input. • [Disable Error Detect] LIINH: Inhibits error detection. The soft starter records the detected errors but doesn't stop running. Automatic assignment: [Disable Error Detect] INH set to digital input, for the mandatory safety measures refer to Smoke Extraction, page 136. • [Device Lock] LILES: Forces open the relay assigned to [Mains Contactor] LLC. Active on low level. Automatic assignment: [Device Lock] LES set to digital input. • [Freewheel Stop] FFSA: Forces a freewheel stop at the next Stop command. Automatic assignment: [Freewheel Assign] FFSA set to digital input. • [Th Error Reset] RSFT: Clear [Motor Overload] OLF error after removing its cause. Automatic assignment: [Th Error Reset Assign] RSFT set to digital input. • [Cascade] CSCA: Part of the cascade sequence, can be used to take control of the motor to apply a stop command by opening the external bypass. Automatic assignment: [Cascade DI Assign] CSCA set to digital input, for the mandatory safety measures refer to Cascade Motors, page 134. • [2nd Mot Param Set] LIS: Applies the second set of parameters. Automatic assignment: [2nd Mot Assign] LIS set to digital input. • [Preheating] PRHA: Starts the preheating. Automatic assignment: [Preheating Assign] PRHA set to digital input. 		

4.3 [DQ1 configuration] DO1

Access path: [Input/Output] IO → [DQ1 configuration] DO1

About this Menu

This menu provides the parameters to assign a function to the digital output DQ1 and to set its active level.

Description	Setting range	Factory setting
[DQ1 Assignment] DO1	–	[Motor Overload Warn] OLMA
<p>DQ1 assignment</p> <p>Access path: [Input/Output] IO → [DQ1 configuration] DO1</p> <p>This parameter sets the condition to activate DQ1:</p> <ul style="list-style-type: none"> • [Not Assigned] NO: Digital output not assigned • [Operating State Fault] FLT: <i>Device in operating state "Fault"</i> • [Device Running] RUN: <i>Device running</i> • [Dev Th reached] TAD: <i>Device thermal threshold reached</i> • [Proc Undld Warn] ULA: <i>Process underload warning</i> • [Proc Overload Warn] OLA: <i>Process overload warning</i> • [HMI L/R cmd] BMP: Control via the display terminal is active (only active with Local/Remote button) • [Mains Contactor] LLC: <i>Mains contactor control</i> • [Warning Grp 1] AG1 to [Warning Grp 5] AG5: <i>Warning group 1 to Warning group 5.</i> • [Ext Error Warn] EFA: <i>External error warning</i> • [UnderV Warn] USA: <i>Undervoltage warning</i> • [Device Th Warn] THA: <i>Device thermal state warning</i> • [Ready] RDY: Ready to start • [Per Type of Stop] STT: Stop according to [Type of stop] STT parameter without triggering an error • [AI1 Th Warning] TP1A: Thermal warning set by [AI1 Th Warn Level] TH1A is active • [Temp Sens AI1 Warn] TS1A: Thermal sensor not operating correctly • [Inhibited Errors] INH: The digital input set to [Disable Error Detect] INH is active • [Motor Overload Warn] OLMA: <i>Motor overload warning</i> • [2nd Mot Param Active] AS2: <i>second set of motor parameters activated</i> 		
 [DQ1 Active at] DO1S	[High Level] POS or [Low Level] NEG	[High Level] POS
<p>DQ1 active level</p> <p>Access path: [Input/Output] IO → [DQ1 configuration] DO1</p> <p>This parameter sets the level applied by DQ1.</p> <ul style="list-style-type: none"> • [High Level] POS: Output applies a high level. • [Low Level] NEG: Output applies a low level. 		

4.4 [DQ2 Configuration] DO2

Access path: [Input/Output] IO → [DQ2 Configuration] DO2

About this Menu

This menu provides the parameters to assign a function to the digital input DQ2 and to set its active level.



Description	Setting range	Factory setting
[DQ2 Assign] DO2	–	[Device Running] RUN
<p>DQ2 assignment</p> <p>Access path: [Input/Output] IO → [DQ2 Configuration] DO2</p> <p>This parameter assigns the condition to activate DQ2.</p> <ul style="list-style-type: none"> • [Not Assigned] NO: Digital output not assigned • [Operating State Fault] FLT: <i>Device in operating state "Fault"</i> • [Device Running] RUN: <i>Device running</i> • [Dev Th reached] TAD: <i>Device thermal threshold reached</i> • [Proc Undld Warn] ULA: <i>Process underload warning</i> • [Proc Overload Warn] OLA: <i>Process overload warning</i> • [HMI L/R cmd] BMP: Control via the display terminal is active (only active with Local/Remote button) • [Mains Contactor] LLC: <i>Mains contactor control</i> • [Warning Grp 1] AG1 to [Warning Grp 5] AG5: <i>Warning group 1 to Warning group 5.</i> • [Ext Error Warn] EFA: <i>External error warning</i> • [UnderV Warn] USA: <i>Undervoltage warning</i> • [Device Th Warn] THA: <i>Device thermal state warning</i> • [Ready] RDY: Ready to start • [Per Type of Stop] STT: Stop according to [Type of stop] STT parameter without triggering an error • [AI1 Th Warning] TP1A: Thermal warning set by [AI1 Th Warn Level] TH1A is active • [Temp Sens AI1 Warn] TS1A: Thermal sensor not operating correctly • [Inhibited Errors] INH: The digital input set to [Disable Error Detect] INH is active • [Motor Overload Warn] OLMA: <i>Motor overload warning</i> • [2nd Mot Param Active] AS2: <i>second set of motor parameters activated</i> 		
 [DQ2 Active at] DO2S	[High Level] POS or [Low Level] NEG	[High Level] POS
<p>DQ2 active at</p> <p>Access path: [Input/Output] IO → [DQ2 Configuration] DO2</p> <p>This parameter sets the level applied by DQ2.</p> <ul style="list-style-type: none"> • [High Level] POS: Output applies a high level. • [Low Level] NEG: Output applies a low level. 		

4.5 [AI1 configuration] AI1

Access path: [Input/Output] IO → [AI1 configuration] AI1

About this Menu

 [AI1 configuration] AI1 provides the parameters to assign a thermal sensor to the analog input AI1/PTC1 and to set a filter on this input.

Description	Setting range	Factory setting
 [AI1 assignment] AI1A	[No] NO or [AI1 Th Monitoring] TH1S	[No] NO
<p>AI1 assignment</p> <p>Access path: [Input/Output] IO → [AI1 configuration] AI1</p> <p>This parameter activates the thermal sensor monitoring on the terminal PTC1/AI1.</p> <ul style="list-style-type: none"> • [No] NO: No function assigned to the terminal PTC1/AI1. • [AI1 Th Monitoring] TH1S: Thermal monitoring on PTC1/AI1 terminal assigned and active with a PTC/PT100 thermal sensor and triggers an error on overheating detection. This allows to take the measured temperature on the motor into account for overheating detection. <p>NOTE: [AI1 Th Monitoring] TH1S cannot be assigned via [AI1 assignment] AI1A in the menu [Input/Output] IO. [AI1 Th Monitoring] TH1S can be assigned only via the parameter in the menu [Monitoring] PROT → [Thermal monitoring] TPP.</p>		
 [AI1 Type] AI1T	–	[PTC] PTC
<p>Configuration of AI1</p> <p>Access path: [Input/Output] IO → [AI1 configuration] AI1</p> <p>This parameter sets the type of thermal sensors wired to PTC1/AI1.</p> <ul style="list-style-type: none"> • [PTC] PTC: 1 to 6 PTC in serial is used. • [PT100] 1PT2 : 1 PT100 connected with 2 wires is used. • [PT100 in 3 wires] 1PT23: 1 PT100 connected with 3 wires is used. 		
 [AI1 filter] AI1F	0...10 s	0 s
<p>AI1 filter</p> <p>Access path: [Input/Output] IO → [AI1 configuration] AI1</p> <p>This parameter sets the cutoff time of the low filter for PTC1/AI1.</p>		

4.6 [AQ1 configuration] AO1

Access path: [Input/Output] IO → [AQ1 configuration] AO1

About this Menu

This menu can be used to set the characteristics of the image of the signal sent by AQ1.

Description	Setting range	Factory setting
[AQ1 assignment] AO1	–	[Motor Current] OCR
<p>AQ1 assignment</p> <p>Access path: [Input/Output] IO → [AQ1 configuration] AO1</p> <p>This parameter sets the characteristics of the image of the signal sent by AQ1.</p> <ul style="list-style-type: none"> • [Not Configured] NO: <i>Not configured</i> • [Motor Current] OCR: <i>Motor current</i> • [Mot Mech Pwr %] OPR: <i>Motor power in %</i> • [Mot Thermal] THR: <i>Motor thermal state</i> • [Power Factor] OCO: <i>Power factor</i> • [Motor Torque] OTR: <i>Motor torque</i> 		
[AQ1 Scaling] AO1S	50...500 %	200 %
<p>Analog output AQ1 scaling</p> <p>Access path: [Input/Output] IO → [AQ1 configuration] AO1</p> <p>This parameter sets the scaling of the maximum of AQ1 real image.</p> <p>If [AQ1 assignment] AO1 is set to [Power Factor] OCO, [AQ1 Scaling] AO1S is forced to 100%.</p> <p>If [AQ1 assignment] AO1 is set to [Mot Thermal] THR, [AQ1 Scaling] AO1S is forced to 300%.</p>		
[AQ1 Type] AO1T	[Voltage] 10U or [Current] 0A	[Current] 0A
<p>AQ1 Type</p> <p>Access path: [Input/Output] IO → [AQ1 configuration] AO1</p> <p>This parameter sets the type of signal applied by AQ1.</p> <ul style="list-style-type: none"> • [Voltage] 10U: 0...10 Vdc • [Current] 0A: 0...20 mA 		

Description	Setting range	Factory setting
[AQ1 min output] AOL1	0...20 mA	0 mA
<p>AQ1 min output value</p> <p>Access path: [Input/Output] IO → [AQ1 configuration] AO1</p> <p>This parameter sets the minimum value applied by AQ1. To comply with analog output 4...20 ma, set [AQ1 min output] AOL1 to 4.</p> <p>This parameter can be accessed if [AQ1 Type] AO1T is set to [Current] OA.</p>		
[AQ1 max output] AOH1	0...20 mA	20 mA
<p>AQ1 max output value</p> <p>Access path: [Input/Output] IO → [AQ1 configuration] AO1</p> <p>This parameter sets the maximum value applied by AQ1.</p> <p>This parameter can be accessed if [AQ1 Type] AO1T is set to [Current] OA.</p>		

Description	Setting range	Factory setting
[AQ1 min Output] UOL1	0...10 V	0 V
<p>AQ1 minimum output</p> <p>Access path: [Input/Output] IO → [AQ1 configuration] AO1</p> <p>This parameter sets the minimum value applied by AQ1.</p> <p>This parameter can be accessed if [AQ1 Type] AO1T is set to [Voltage] 10U.</p>		
[AQ1 max Output] UOH1	0...10 V	10 V
<p>AQ1 maximum output</p> <p>Access path: [Input/Output] IO → [AQ1 configuration] AO1</p> <p>This parameter sets the maximum value applied by AQ1.</p> <p>This parameter can be accessed if [AQ1 Type] AO1T is set to [Voltage] 10U.</p>		
[Scaling AQ1 Min] ASL1	0...100 %	0 %
<p>Scaling AQ1 min</p> <p>Access path: [Input/Output] IO → [AQ1 configuration] AO1</p> <p>This parameter sets the minimum scaling of the signal applied by AQ1.</p> <p>If [Scaling AQ1 Min] ASL1 is superior to [Scaling AQ1 Max] ASH1, [Scaling AQ1 Min] ASL1 is forced equal to [Scaling AQ1 Max] ASH1.</p> <div style="display: flex; align-items: flex-start;"> <div style="flex: 1;"> <p>The graph plots Scaling (S) on the y-axis against Real image (R) on the x-axis. The y-axis has markers for 0V/0mA at the origin and 10V/20mA at the top. The x-axis has markers for 0% and 100%. A blue line starts at point (b) on the y-axis and extends to a point on the line. Dashed lines indicate the coordinates of point (a) and point (b).</p> </div> <div style="flex: 0.5; margin-left: 20px;"> <ul style="list-style-type: none"> • S: Scaling • R: Real image • (a): Maximum scaling • (b): Minimum scaling </div> </div>		

Description	Setting range	Factory setting
[Scaling AQ1 Max] ASH1	0...100 %	100 %
<p>Scaling AQ1 max</p> <p>Access path: [Input/Output] IO → [AQ1 configuration] AO1</p> <p>This parameter sets the scaling of maximum the signal applied by AQ1.</p> <p>If [Scaling AQ1 Max] ASH1 is inferior to [Scaling AQ1 Min] ASL1, [Scaling AQ1 Max] ASH1 is forced equal to [Scaling AQ1 Min] ASL1.</p>		
 [AQ1 Filter] AO1F	0...10 s	0 s
<p>AQ1 filter</p> <p>Access path: [Input/Output] IO → [AQ1 configuration] AO1</p> <p>This parameter sets the cutoff time of the low filter.</p>		

4.7 [R1 configuration] R1

Access path: [Input/Output] IO → [R1 configuration] R1

About this Menu

This menu provides the parameters to assign the functions **[Operating State Fault]** FLT or **[Isolating Relay]** ISOL to the relay R1, to set its active level and holding time.

Description	Setting range	Factory setting
[R1 Assignment] R1	[Operating State Fault] FLT or [Isolating Relay] ISOL	[Operating State Fault] FLT
<p>R1 assignment</p> <p>Access path: [Input/Output] IO → [R1 configuration] R1</p> <p>This parameter assigns the condition for R1 to activate. This allows to command an external contactor placed upstream in the mains supply.</p> <ul style="list-style-type: none"> • [Operating State Fault] FLT: Close R1 when the soft starter is supplied and no error is detected. Open R1 when an error is detected or when the soft starter control supply CL1/CL2 is lost. • [Isolating Relay] ISOL: Close R1 when a Run or preheating order is applied. Open R1 at the end of stop sequence for breaking or deceleration, at the stop order if freewheel. 		



4.9 [R3 configuration] R3

Access path: [Input/Output] IO → [R3 configuration] R3

About this Menu

This menu provides the parameters to assign a function to the relay R3, to set its active level and holding time.

Description	Setting range	Factory setting
[R3 Assignment] R3	–	[Device Running] RUN
<p>R3 assignment</p> <p>Access path: [Input/Output] IO → [R3 configuration] R3</p> <ul style="list-style-type: none"> • [Not Assigned] NO: Relay R3 not assigned • [Operating State Fault] FLT: Activates R3 when the soft starter is supplied Deactivates R3 when an error is detected. The motor stops in freewheel when an error is detected. • [Mains Contactor] LLC: Activate R3 on a Run or Preheating order to close the mains contactor upstream the soft starter. • [HMI L/R cmd] BMP: Control via the display terminal is active (only active with Local/Remote button) • [Ready] RDY: Ready to start • [Device Running] RUN: <i>Device running</i> • [Per Type of Stop] STT: Stop according to [Type of stop] STT parameter without triggering an error • [Warning Grp 1] AG1 to [Warning Grp 5] AG5: <i>Warning group 1 to Warning group 5.</i> • [AI1 Th Warning] TP1A: Thermal warning set by [AI1 Th Warn Level] TH1A is active • [Temp Sens AI1 Warn] TS1A: Thermal sensor not operating correctly • [Device Th Warn] THA: <i>Device thermal state warning</i> • [Ext Error Warn] EFA: <i>External error warning</i> • [UnderV Warn] USA: <i>Undervoltage warning</i> • [Inhibited Errors] INH: The digital input set to [Disable Error Detect] INH is active • [Proc Undld Warn] ULA: <i>Process underload warning</i> • [Proc Overload Warn] OLA: <i>Process overload warning</i> • [Motor Overload Warn] OLMA: <i>Motor overload warning</i> • [Dev Th reached] TAD: <i>Device thermal threshold reached</i> • [2nd Mot Param Active] AS2: <i>second set of motor parameters activated</i> 		

Description	Setting range	Factory setting
 [R3 Active at] R3S	[High Level] POS or [Low Level] NEG	[High Level] POS
<p>R3 active level</p> <p>Access path: [Input/Output] IO → [R3 configuration] R3</p> <p>This parameter sets the level applied by R3 when activated.</p> <ul style="list-style-type: none"> • [High Level] POS: R3 applies a high level when activated. • [Low Level] NEG: R3 applies a low level when deactivated. <p>[R3 Active at] R3S is forced to [High Level] POS if [R3 Assignment] R3 is set to [Mains Contactor] LLC.</p>		
 [R3 Holding time] R3H	0...9999 ms	0 ms
<p>R3 holding time</p> <p>Access path: [Input/Output] IO → [R3 configuration] R3</p> <p>This parameter sets the holding time delay for R3 after which the relay state will actually be changed when a state change is ordered.</p> <p>[R3 Holding time] R3H is forced to 0 if [R3 Assignment] R3 is set to [Mains Contactor] LLC.</p>		

5 [2nd Mot Parameters] ST2

This menu provides a second set of parameters that can be used with the same soft starter. For more information refer to [Second Motor Parameters](#), page 131.

Access path: [\[2nd Mot Parameters\] ST2](#)



[\[2nd Mot Parameters\] ST2](#) menu navigation

5.1 [2nd Mot Assign] LIS	5.4 [Acceleration Motor 2] ACM2	5.7 [End Of Dec Motor 2] EDM2
5.2 [Nom Current Motor 2] INM2	5.5 [Init Start Torque Mot 2] TQM2	5.8 [Torque Limit Motor 2] TLM2
5.3 [Current Limit Motor 2] ILM2	5.6 [Deceleration Motor 2] DEM2	5.9 [Dec Gain Motor 2] TIM2

For more information, refer to [Second Motor Parameters](#), page 131.

6 [Communication] COM

What's in This Chapter

6.1 [Modbus Fieldbus] MD1	196
6.2 [Eth Module Config] ETO	200
6.3 [CANopen] CNO	200
6.4 [Profibus] PBC	200
6.5 [Profinet] PNC	200
6.6 [Communication map] CMM.....	201

About this menu

This menu provides the parameters to set the fieldbus communication and the communication between the soft starter and the display terminal.



[Communication] COM menu navigation

<p>6.1 [Modbus Fieldbus] MD1</p> <p>[Modbus Address] ADD</p> <p>[Modbus Baud Rate] TBR</p> <p>[Term word order] TWO</p> <p>[Modbus Format] TFO</p> <p>[Modbus Timeout] TTO</p> <p>[Modbus Error Resp] SLL</p> <p>[Com. scanner input] ICS</p> <p>[Com. scanner output] OCS</p> <p>[Product restart] RP</p>	<p>6.2 [Eth Module Config] ETO</p> <p>6.3 [CANopen] CNO</p> <p>6.4 [Profibus] PBC</p> <p>6.5 [Profinet] PNC</p> <p>6.6 [Communication map] CMM</p>
--	--

6.1 [Modbus Fieldbus] MD1

Access path: [Communication] COM → [Modbus Fieldbus] MD1

About this Menu

This menu provides the parameters to set the embedded Modbus fieldbus. For more information refer to the embedded Modbus manual.

HMI label	Setting	Factory setting
[Modbus Address] <small>ADD</small>	0...247	0
<p>Device modbus address</p> <p>Access path: [Communication] COM → [Modbus Fieldbus] MD1</p> <p>This parameter sets the embedded Modbus device address.</p> <p>Address 0 is reserved for point to point connection.</p>		
[Modbus Baud Rate] <small>TBR</small>	–	[19200 bps] 19200
<p>Modbus baud rate</p> <p>Access path: [Communication] COM → [Modbus Fieldbus] MD1</p> <p>This parameter sets the embedded Modbus baud rate.</p> <ul style="list-style-type: none"> • [Automatic] <small>AUTO</small>: Automatic detection • [4800 bps] <small>4800</small>: 4,800 bauds • [9600 bps] <small>9600</small>: 9,600 bauds • [19200 bps] <small>19200</small>: 19,200 bauds • [38.4 Kbps] <small>38400</small>: 38,400 bauds 		
 [Term word order] <small>TWO</small>	[OFF] <small>LOW</small> or [ON] <small>HIGH</small>	[ON] <small>HIGH</small>
<p>Terminal Modbus: Word order</p> <p>Access path: [Communication] COM → [Modbus Fieldbus] MD1</p> <p>This parameter sets the embedded Modbus terminal word order.</p> <ul style="list-style-type: none"> • [OFF] <small>LOW</small>: Low word first • [ON] <small>HIGH</small>: High word first 		
[Modbus Format] <small>TFO</small>	–	[8-E-1] <small>8E1</small>
<p>Modbus format</p> <p>Access path: [Communication] COM → [Modbus Fieldbus] MD1</p> <p>This parameter sets the embedded Modbus frame format.</p> <p>NOTE: Connection to SoMove is done using the format [8-E-1] <small>8E1</small>.</p> <ul style="list-style-type: none"> • [8-O-1] <small>8O1</small>: 8 bits odd parity 1 stop bit • [8-E-1] <small>8E1</small>: 8 bits even parity 1 stop bit • [8-N-1] <small>8N1</small>: 8 bits no parity 1 stop bit • [8-N-2] <small>8N2</small>: 8 bits no parity 2 stop bits 		

HMI label	Setting	Factory setting
[Modbus Timeout] TTO	0.1...30 s	5 s
<p>Modbus timeout</p> <p>Access path: [Communication] COM → [Modbus Fieldbus] MD1</p> <p>This parameter sets the embedded Modbus communication timeout.</p>		
[Modbus Error Resp] SLL	–	[Freewheel Stop] YES
<p>Response to Modbus interruption</p> <p>Access path: [Communication] COM → [Modbus Fieldbus] MD1</p> <p>This parameter sets the type of stop applied to the motor when a loss of communication is detected on the Modbus channel for both ports.</p> <ul style="list-style-type: none"> • [Ignore]: Trigger [Modbus Com Warn] SLLA. The warning should be assigned to a warning group in [Warn groups config] to be visible when triggered. Refer to <i>Warning Messages</i>, page 252. • [Freewheel Stop]: Error [Mdb Com Interrupt] SLF1 is triggered and motor stops in freewheel. • [Configured Stop]: Motor stops according to the value set in [Type of stop], [Modbus Com Warn] SLLA is triggered. • [Deceleration]: Motor stops in deceleration and an error [Mdb Com Interrupt] SLF1 is triggered at the end of deceleration. • [Braking]: Motor stops in dynamic braking stop and an error [Mdb Com Interrupt] SLF1 is triggered at the end of stop. 		
⚠ WARNING		
<p>LOSS OF CONTROL</p> <p>If this parameter is set to [Ignore], fieldbus module communication monitoring is disabled.</p> <ul style="list-style-type: none"> • Only use this setting after a thorough risk assessment in compliance with all regulations and standards that apply to the device and to the application. • Only use this setting for tests during commissioning. • Verify that communication monitoring has been re-enabled before completing the commissioning procedure and performing the final commissioning test. <p>Failure to follow these instructions can result in death, serious injury, or equipment damage.</p>		
[Product restart] RP	–	[Not Assigned] NO
<p>Product restart</p> <p>Access path: [Communication] COM → [Modbus Fieldbus] MD1</p> <p>Manually restart the device via the HMI. Press and hold the OK button on the display terminal for 2 seconds to restart the device.</p> <p>This parameter is automatically set to [Not Assigned] NO after restart.</p> <ul style="list-style-type: none"> • [Not Assigned] NO: No restart • [Yes] YES: Restart the soft starter <p>The Restart function performs a Fault Reset and then restarts the device. During this Restart procedure, the device goes through the same steps as if it had been switched off and on again. Depending on the wiring and the configuration of the device, this may result in immediate and unanticipated operation.</p>		
⚠ WARNING		
<p>UNANTICIPATED EQUIPMENT OPERATION</p> <p>The Restart function performs a Fault Reset and restarts the device.</p> <ul style="list-style-type: none"> • Verify that activating this function does not result in unsafe conditions. <p>Failure to follow these instructions can result in death, serious injury, or equipment damage.</p>		

[Com. scanner input] ICS

HMI label	Setting	Factory setting
[Scan. IN1 address] <i>NMA1</i>	0...65535	Status (ETA)
Scan input 1 address Access path: [Communication] COM → [Modbus Fieldbus] MD1 → [Com. scanner input] ICS Address of the first input word.		
[Scan. IN2 address] <i>NMA2</i>	0...65535	LCR
Scan input 2 address Access path: [Communication] COM → [Modbus Fieldbus] MD1 → [Com. scanner input] ICS Address of the second input word.		
[Scan. IN3 address] <i>NMA3</i>	0...65535	THR
Scan input 3 address Access path: [Communication] COM → [Modbus Fieldbus] MD1 → [Com. scanner input] ICS Address of the third input word.		
[Scan. IN4 address] <i>NMA4</i>	0...65535	ERRD
Scan input 4 address Access path: [Communication] COM → [Modbus Fieldbus] MD1 → [Com. scanner input] ICS Address of the fourth input word.		
[Scan. IN5 address] <i>NMA5</i>	0...65535	0
Scan input 5 address Access path: [Communication] COM → [Modbus Fieldbus] MD1 → [Com. scanner input] ICS Address of the fifth input word.		
[Scan. IN6 address] <i>NMA6</i>	0...65535	0
Scan input 6 address Access path: [Communication] COM → [Modbus Fieldbus] MD1 → [Com. scanner input] ICS Address of the sixth input word.		
[Scan. IN7 address] <i>NMA7</i>	0...65535	0
Scan input 7 address Access path: [Communication] COM → [Modbus Fieldbus] MD1 → [Com. scanner input] ICS Address of the seventh input word.		
[Scan. IN8 address] <i>NMA8</i>	0...65535	0
Scan input 8 address Access path: [Communication] COM → [Modbus Fieldbus] MD1 → [Com. scanner input] ICS Address of the eighth input word.		

[Com. scanner output] OCS

HMI label	Setting	Factory setting
[Scan.Out1 address] NCA1	0...65535	Command (CMD)
Scan output 1 address		
Access path: [Communication] COM → [Modbus Fieldbus] MD1 → [Com. scanner output] OCS		
Address of the first output word.		
[Scan.Out2 address] NCA2	0...65535	0
Scan output 2 address		
Access path: [Communication] COM → [Modbus Fieldbus] MD1 → [Com. scanner output] OCS		
Address of the second output word.		
[Scan.Out3 address] NCA3	0...65535	0
Scan output 3 address		
Access path: [Communication] COM → [Modbus Fieldbus] MD1 → [Com. scanner output] OCS		
Address of the third output word.		
[Scan.Out4 address] NCA4	0...65535	0
Scan output 4 address		
Access path: [Communication] COM → [Modbus Fieldbus] MD1 → [Com. scanner output] OCS		
Address of the fourth output word.		
[Scan.Out5 address] NCA5	0...65535	0
Scan output 5 address		
Access path: [Communication] COM → [Modbus Fieldbus] MD1 → [Com. scanner output] OCS		
Address of the fifth output word.		
[Scan.Out6 address] NCA6	0...65535	0
Scan output 6 address		
Access path: [Communication] COM → [Modbus Fieldbus] MD1 → [Com. scanner output] OCS		
Address of the sixth output word.		
[Scan.Out7 address] NCA7	0...65535	0
Scan output 7 address		
Access path: [Communication] COM → [Modbus Fieldbus] MD1 → [Com. scanner output] OCS		
Address of the seventh output word.		
[Scan.Out8 address] NCA8	0...65535	0
Scan output 8 address		
Access path: [Communication] COM → [Modbus Fieldbus] MD1 → [Com. scanner output] OCS		
Address of the eighth output word.		

6.2 [Eth Module Config] ETO

Access path: [Communication] COM → [Eth Module Config] ETO

About this Menu

This menu provides the parameters to set the Ethernet IP / Modbus TCP communication. This menu is visible only if the module VW3A3720 is plugged into the soft starter.

Refer to the ATS480 Ethernet IP Modbus TCP Manual (NNZ85540) for more information.

6.3 [CANopen] CNO

Access path: [Communication] COM → [CANopen] CNO

About this Menu

This menu provides the parameters to set the CANopen fieldbus communication. This menu is visible only if the module VW3A3608, VW3A3618 or VW3A3628 is plugged into the soft starter.

Refer to the ATS480 CANopen fieldbus manual (NNZ85543) for more information.

6.4 [Profibus] PBC

Access path: [Communication] COM → [Profibus] PBC

About this Menu

This menu provides the parameters to set the Profibus fieldbus communication. This menu is visible only if the module VW3A3607 is plugged into the soft starter.

Refer to the ATS480 PROFIBUS DP Manual (NNZ85542) for more information.

6.5 [Profinet] PNC

Access path: [Communication] COM → [Profinet] PNC

About this Menu

This menu provides the parameters to set the PROFINET fieldbus communication. This menu is visible only if the module VW3A3647 is plugged into the soft starter.

Refer to the ATS480 PROFINET Manual (NNZ85541) for more information.

6.6 [Communication map] CMM

Access path: [Communication] COM → [Communication map] CMM

About this Menu

This menu provides the parameters for the input and output communications of the soft starter.

HMI label	Setting	Factory setting
[Command Channel] CMDC	–	[Terminals] [Terminals]
<p>Command channel</p> <p>Access path: [Communication] COM → [Communication map] CMM</p> <ul style="list-style-type: none"> • [Terminals] TER: Control via terminal block • [HMI] LCC: Command via Graphic Display Terminal • [Modbus] MDB: Command via Modbus • [CANopen] CAN: Command via CANopen if a CANopen module has been inserted • [Com. Module] NET: Command via fieldbus module if a fieldbus module has been inserted • [PC tool] PWS: Command via DTM-based commissioning software • [Not Available] NA: Command channel not available 		

HMI label	Setting	Factory setting
[Cmd Register] CMD	–	–

Command register

Access path: [Communication] **COM** → [Communication map] **CMM**

Possible values when [Control Mode] **CHCF** is set to [Standard Profile] **STD**.

The assignments in the table below are the default assignments. When assigning a new function to the reassignable bits, the default assignment is erased and only the newly assigned function can be called.

The default assignments are available again when the newly assigned function is unassigned.

Bit	Description, value
0	Set to 1: "Switch on", Mains contactor command
1	Set to 1: "Enable voltage", Authorization to supply power
2	Set to 0: "Quick stop" active
3	Set to 1: "Enable operation", Run command active
4 to 6	Reserved (= 0)
7	"Error reset" acknowledgment active on 0 to 1 rising edge
8	Set to 1: Stop command according to [Type of stop] STT
9 to 10	Reserved (= 0)
11	Reassignable user bit, active at 1
12	Reassignable user bit, active at 1
13	Reassignable. Set to 1: [Braking] B stop command
14	Reassignable. Set to 1: [Deceleration] D stop command
15	Reassignable user bit, active at 1

Possible values when [Control Mode] **CHCF** is set to [SE8 Profile] **SE8**:

Bit	Description, value
0	Set to 1: "Switch on", Mains contactor command
1	Set to 0: "Disable voltage", Authorization to supply power
2	Set to 0: "Quick stop" active
3	Set to 1: "Enable operation", Run command active
4 to 6	Reserved (= 0)
7	"Error reset" acknowledgment active on 0 to 1 rising edge
8	Command released (0: "In line mode / 1: "In local mode")
9 to 11	Reserved (= 0)
12	Set to 1: Stop command according to [Type of stop] STT
13	Set to 1: [Braking] B stop command
14	Set to 1: [Deceleration] D stop command
15	Local / Line mode selection (0: "In line mode / 1: "In local mode")

HMI label	Setting	Factory setting
[Status Register] <i>ETA</i>	–	–
Status Register		
Access path: [Communication] COM → [Communication map] CMM		
Status word:		
Bit	Description, value	
0	Set to 1: Ready to switch on	
1	Set to 1: Switched on	
2	Set to 1: Operation enabled	
3	Set to 1: Detected error state	
4	Set to 0: <ul style="list-style-type: none"> Mains supply available when [Control Mode] CHCF set to [SE8 Profile] SE8 Mains supply unavailable when [Control Mode] CHCF set to [Standard Profile] STD Set to 1: <ul style="list-style-type: none"> Mains supply unavailable when [Control Mode] CHCF set to [SE8 Profile] SE8 Mains supply available when [Control Mode] CHCF set to [Standard Profile] STD 	
5	Set to 0: Quick stop active	
6	Set to 1: Switch-on disabled	
7	Set to 1: Warning is triggered	
8	Reserved	
9	Set to 0: <ul style="list-style-type: none"> Forced local channel not active when [Control Mode] CHCF set to [SE8 Profile] SE8 Forced local channel active when [Control Mode] CHCF set to [Standard Profile] STD Set to 1: <ul style="list-style-type: none"> Command via local channel when [Control Mode] CHCF set to [SE8 Profile] SE8 Command via remote channel when [Control Mode] CHCF set to [Standard Profile] STD 	
10 to 13	Reserved	
14	Set to 1: Stop imposed by STOP button	
15	Reserved	

[Modbus network diag] MND

Access path: [Communication] COM – → [Communication map] CMM

Used for the Modbus serial communication port at the bottom of the control block. Refer to the Modbus serial embedded communication manual for a complete description.

HMI label	Setting	Factory setting
[COM LED] <small>MDB1</small>	–	–
COM LED Access path: [Communication] COM → [Communication map] CMM → [Modbus network diag] MND View of the Modbus communication LED.		
[Mdb Frame Nb] <small>M1CT</small>	0...65535	Read only
Mdb frame number Access path: [Communication] COM → [Communication map] CMM → [Modbus network diag] MND Modbus network frames counter: number of processed frames.		
[Mdb CRC errors] <small>M1EC</small>	0...65535	Read only
Mdb CRC errors Access path: [Communication] COM → [Communication map] CMM → [Modbus network diag] MND Modbus network CRC error counter: number of CRC errors		
[Mdb com stat] <small>COM1</small>	–	–
Modbus com. status Access path: [Communication] COM → [Communication map] CMM → [Modbus network diag] MND Modbus communication status. <ul style="list-style-type: none"> • [R0T0] <small>R0T0</small>: Modbus no reception, no transmission • [R0T1] <small>R0T1</small>: Modbus no reception, transmission • [R1T0] <small>R1T0</small>: Modbus reception, no transmission • [R1T1] <small>R1T1</small>: Modbus reception and transmission 		

[Com. scan input map] ISA

Access path: [Communication] COM → [Communication map] CMM → [Modbus network diag] MND

Used for CANopen® and Modbus network.

Information provide to [Com Scan In1 val.] NM1 to [Com Scan In8 val.] NM8

HMI label	Setting	Factory setting
[Com Scan In1 val.] NM1	0..65535	Read only
<p>Com scan input 1 value</p> <p>Access path: [Communication] COM → [Communication map] CMM → [Modbus network diag] MND → [Com. scan input map] ISA</p> <p>Com scanner input 1 value. Value of the first input word.</p>		
[Com Scan In8 val.] NM8	0..65535	Read only
<p>Com scan input 8 value</p> <p>Access path: [Communication] COM → [Communication map] CMM → [Modbus network diag] MND → [Com. scan input map] ISA</p> <p>Com scanner input 8 value. Value of the eighth input word.</p>		

[Com scan output map] OSA

Access path: [Communication] COM → [Communication map] CMM → [Modbus network diag] [Com scan output map]

Used for CANopen® and Modbus network.

Information provide to [Com Scan Out1 val.] NC1 to [Com Scan Out8 val.] NC8

HMI label	Setting	Factory setting
[Com Scan Out1 val.] NC1	0...65535	Read only
<p>Com scan output 1 value</p> <p>Access path: [Communication] COM → [Communication map] CMM → [Modbus network diag] MND → [Com scan output map] OSA</p> <p>Com scanner output 1 value. Value of the first output word.</p>		
[Com Scan Out8 val.] NC8	0...65535	Read only
<p>Com scan output 8 value</p> <p>Access path: [Communication] COM → [Communication map] CMM → [Modbus network diag] MND → [Com scan output map] OSA</p> <p>Com scanner output 8 value. Value of the eighth output word.</p>		

[Modbus HMI Diag] MDH

Access path [Communication] COM – → [Communication map] CMM

Used for the Modbus serial communication port at the front of the control block (used by the Display Terminal)

HMI label	Setting	Factory setting
[COM LED] MDB2	–	–
COM LED Access path: [Communication] COM → [Communication map] CMM → [Modbus HMI Diag] MDH View of the Modbus HMI communication LED.		
[Mdb Net frames] M2CT	0...65535	Read only
Mdb NET frames Access path: [Communication] COM → [Communication map] CMM → [Modbus HMI Diag] MDH Terminal Modbus 2: number of processed frames.		
[Mdb Net CRC errors] M2EC	0...65535	Read only
Mdb CRC errors Access path: [Communication] COM → [Communication map] CMM → [Modbus HMI Diag] MDH Terminal Modbus 2: number of CRC errors.		
[Mdb com stat] COM2	–	–
Mdb com stat Access path: [Communication] COM → [Communication map] CMM → [Modbus HMI Diag] MDH Modbus HMI communication status. <ul style="list-style-type: none"> • [R0T0] R0T0: Modbus no reception, no transmission • [R0T1] R0T1: Modbus no reception, transmission • [R1T0] R1T0: Modbus reception, no transmission • [R1T1] R1T1: Modbus reception and transmission 		

[Ethernet Module Diag] MTE

Access path: [Communication] COM – → [Communication map] CMM

Refer to the Ethernet Option Module manual.

[Profibus diag] PRB

Access path: [Communication] COM – → [Communication map] CMM

Refer to the PROFIBUS Option Module manual.

[Profinet diag] PRN

Access path: [Communication] COM – → [Communication map] CMM

Refer to the PROFINet Option Module manual.

[Cmd word image] CWI

Access path: [Communication] COM → [Communication map] CMM

Command word image.

HMI label	Setting	Factory setting
[Modbus Cmd] CMD1	–	–
<p>Modbus command register</p> <p>Access path: [Communication] COM → [Communication map] CMM → [Cmd word image] CWI</p> <p>Command word image built with Modbus port source.</p> <p>Identical to [Cmd Register] CMD.</p>		
[CANopen Cmd] CMD2	–	–
<p>CANopen command register</p> <p>Access path: [Communication] COM → [Communication map] CMM → [Cmd word image] CWI</p> <p>Command word image built with CANopen® port source.</p> <p>Identical to [Cmd Register] CMD.</p>		
[COM. Module cmd.] CMD3	–	–
<p>DrivecomCmdRegCom.</p> <p>Access path: [Communication] COM → [Communication map] CMM → [Cmd word image] CWI</p> <p>Command word image built with fieldbus module source.</p> <p>Identical to [Cmd Register] CMD.</p>		

[CANopen map] CNM

Access path:[Communication] COM → [Communication map] CMM

Refer to the CANopen Option Module manual.

7 [Display] MON

What's in This Chapter

7.1 [Motor parameters] MMO	210
7.2 [Thermal Monitoring] TPM	212
7.3 [Counter Management] ELT	213
7.4 [Other State] SST	214
7.5 [I/O Map] IOM	215
7.6 [Energy parameters] ENP	218

About this menu

This menu provides the parameters to monitor the key physical values of the motor, the soft starter and the application such as:

- Motor electrical and torque values
- Device and motor thermal state
- Device and motor run time
- State of the device
- Inputs/Outputs assignment



[Display] MON menu navigation

<p>7.1 [Motor parameters] MMO</p> <p>[Power Factor] COS</p> <p>[Motor Current] LCR</p> <p>[Motor Current] OCR</p> <p>[Acv Elc Out Pwr in %] EPR</p> <p>[Acv Elc Out Pwr in kW] EPRW</p> <p>[Motor Torque] LTR</p> <p>[Phase Direction] PHE</p> <p>[Mains Frequency] FAC</p> <p>[In Delta Diag Status] DLTS</p> <hr/> <p>7.2 [Thermal Monitoring] TPM</p> <p>[Motor Therm State] THR</p> <p>[Al1 Th Value] TH1V</p> <p>[Device Thermal State] THS</p>	<p>7.3 [Counter Management] ELT</p> <p>[Motor Run Time] RTHH</p> <p>[Power-on time] PTHH</p> <p>[Nb Of Starts] NSM</p> <p>[Bypass Cycle Count] BPCN</p> <p>[Counter Reset] RPR</p> <hr/> <p>7.4 [Other State] SST</p> <p>[Automatic restart] AUTO</p> <p>[Type of stop] STT</p> <p>[Bypass Active] BYP</p> <p>[Braking Active] BRL</p> <p>[Steady State] SDY</p> <p>[Bypass Relay Active] BPS</p> <p>[Wait Before Restart] TBS</p> <p>[2nd Motor Selected] AS2</p> <p>[Simu Mode Active] SIM</p>	<p>7.5 [I/O Map] IOM</p> <p>[Digital Input Map] LIA</p> <p>[Analog inputs image] AIA</p> <p>[Digital Output Map] LOA</p> <p>[Analog outputs image] AOA</p> <hr/> <p>7.6 [Energy parameters] ENP</p> <p>[Acv Elc Out Pwr in kW] EPRW</p> <p>[Elc Egy Today] OCT</p> <p>[Elc Egy Yesterday] OCY</p> <p>[Elc Energy Cons] OC4</p> <p>[Elc Energy Cons] OC3</p> <p>[Elc Energy Cons] OC2</p> <p>[Elc Energy Cons] OC1</p> <p>[Elc Energy Cons] OC0</p> <p>[Peak Elec Out Power] MOEP</p>
--	--	---

7.1 [Motor parameters] MMO

Access path: [Display] SUP → [Motor parameters] MMO

About This Menu

This menu provides the parameters to monitor key electrical measurements on the motor and motor torque.

HMI label	Display	Factory setting
[Power Factor] COS	0.00...1.00	–
Power factor Access path: [Display] SUP → [Motor parameters] MMO Power Factor.		
[Motor Current] LCR	0...5 times the soft starter current rating	–
Motor current Access path: [Display] SUP → [Motor parameters] MMO RMS motor current. Average of the three line currents based on the measurement of the fundamental of the motor line currents.		
[Motor Current] OCR	0...500 %	–
Motor current Access path: [Display] SUP → [Motor parameters] MMO RMS motor current in percent of nominal current		
[Acv Elc Out Pwr in %] EPR	0...500 %	–
Active Electrical output power in % Access path: [Display] SUP → [Motor parameters] MMO Active electrical output power in % of motor nominal power.		
[Acv Elc Out Pwr in kW] EPRW	0...(1) kW	–
Active Electrical output power in kW Access path: [Display] SUP → [Motor parameters] MMO Active electrical output power calculated, with the formula $EPRW = ULN \times \sqrt{3} \times LCR \times COS$. (1): Max value according to soft starter rating.		
[Motor Torque] LTR	0...255 %	–
Torque reference Access path: [Display] SUP → [Motor parameters] MMO Motor torque in percent of the nominal torque.		

HMI label	Display	Factory setting
[Phase Direction] PHE	–	–
<p>Detected phase direction</p> <p>Access path: [Display] SUP → [Motor parameters] MMO</p> <p>This parameter is used to indicate the Phase rotation direction :</p> <ul style="list-style-type: none"> • [Not Recognized] : The network direction has not been detected. • [123] : The soft starter is connected in direct network. • [321] : The soft starter is connected in indirect network. 		
[Mains Frequency] FAC	0...100.0Hz	–
<p>Mains frequency</p> <p>Access path: [Display] SUP → [Motor parameters] MMO</p> <p>Estimated Frequency value of the mains.</p>		
[In Delta Diag Status] DLTS	–	[Not Done] NA
<p>Inside Delta diagnostics status</p> <p>Access path: [Display] SUP → [Motor parameters] MMO</p> <ul style="list-style-type: none"> • [Not Done] NA: diagnostic not done. • [Passed] OK: motor well wired. • [Invert L2 & L3] 32: inversion of phase 2 and 3. • [Invert L1 & L2] 21: inversion of phase 1 and 2. • [Invert L1 & L3] 31: inversion of phase 1 and 3. • [Change 123 to 312] 312: circular permutation (phase 1 towards 3, phase 2 towards 1 and 3 towards 2). • [Change 123 to 231] 231: circular permutation (phase 1 towards 2, phase 2 towards 3 and 3 towards 1). • [Bad Motor Wiring] MOT: motor cable bad wiring. • [Unknown Error] UNK: unknown error (missing wire, 2 phases on same motor phase, motor in line,...). • [Pending] PEND: diagnostic pending. 		

7.2 [Thermal Monitoring] TPM

Access path: [Display] SUP → [Process overload] OLD

About this Menu

This menu provides the parameters to monitor the thermal state of the soft starter and the motor.

HMI label	Display	Factory setting
[Motor Therm State] THR	0...300 %	–
<p>Motor thermal state</p> <p>Access path: [Display] SUP → [Thermal Monitoring] TPM</p> <p>This parameter monitors the motor thermal state. 100% corresponds to the nominal thermal state at the nominal motor current set to [Motor Nom Current] IN.</p> <p>If a thermal sensor is wired, refer to the chapter 2.11 [Thermal monitoring] TPP, page 153.</p>		
[AI1 Th Value] TH1V	-15.0...200.0°C	–
<p>AI1 thermal value</p> <p>Access path: [Display] SUP → [Thermal Monitoring] TPM</p> <p>This parameter monitors the temperature measured by the thermal sensor on the AI1/PTC1 terminal.</p> <p>This parameter can be accessed if [AI1 Type] AI1T is not set to [PTC] PTC.</p> <p>For more information, refer to the chapter 2.11 [Thermal monitoring] TPP, page 153.</p>		
[Device Thermal State] THS	0...200 %	–
<p>Device thermal state</p> <p>Access path: [Display] SUP → [Thermal Monitoring] TPM</p> <p>This thermal estimation is provided by a probe fitted on the heatsink.</p> <p>The value 100 % represent the Nominal thermal state.</p>		

7.3 [Counter Management] ELT

Access path: [Display] SUP → [Counter Management] ELT

About This Menu

This menu provides the parameters to monitor the counters and reset them.

HMI label	Display	Factory setting
[Motor Run Time] RTHH	0...429496729.5 h	0
<p>Motor run time</p> <p>Access path: [Display] SUP → [Counter Management] ELT</p> <p>This parameter monitors how long the motor has been energized.</p>		
[Power-on time] PTHH	0...429496729.5 h	0
<p>Power-on time</p> <p>Access path: [Display] SUP → [Counter Management] ELT</p> <p>This parameter monitors how long the soft starter has been powered-on (control block supplied).</p>		
[Nb Of Starts] NSM	0...4294967295	0
<p>Number of motor starts</p> <p>Access path: [Display] SUP → [Counter Management] ELT</p>		
[Bypass Cycle Count] BPCN	0...4294967295	0
<p>Bypass cycle count</p> <p>Access path: [Display] SUP → [Counter Management] ELT</p> <p>This parameter monitors the number of times the external bypass has been activated.</p>		
[Counter Reset] RPR	–	[No] NO
<p>Counter reset</p> <p>Access path: [Display] SUP → [Counter Management] ELT</p> <p>Set the parameter to :</p> <ul style="list-style-type: none"> • [No] NO: No counter reset • [Reset Cons] APH to reset the counters of the energy consumption. • [Reset Run Time] RTH to reset the counter displaying how long the motor has been energized. • [Reset Pw On Time] PTH to reset the counter displaying how long the soft start has been powered-on. • [Reset Start Count] NSM to reset the number of motor starts counter. • [Reset Bypass Count] BPCN: Reset bypass counter • [Reset All] ALLC: Reset all counters 		

7.4 [Other State] SST

Access path: [Display] SUP → [Other State] SST

About this Menu

This menu displays non-error states:

- **[Automatic restart]** AUTO : Automatic restart attempts in progress.
- **[Type of stop]** STT : Stop following value set to **[Type of stop]** STT
- **[Bypass Active]** BYP : Bypass active.
- **[Braking Active]** BRL : Braking active.
- **[Steady State]** SDY : Steady state reached.
- **[Bypass Relay Active]** BPS : Bypass relay activated.
- **[Wait Before Restart]** TBS : Time before restarting.
- **[2nd Motor Selected]** AS2 : 2nd set of motor parameters activation.
- **[Simu Mode Active]** SIM : Simulation Mode is active.

7.5 [I/O Map] IOM

Access path: [Display] SUP → [Process overload] OLD

About this Menu

This menu provides the parameters to monitor the functions assigned to the inputs / outputs of the soft starter.

This menu is divided into several sub-menus:

- **[Digital Input Map] LIA**: The mapping of the digital inputs,
- **[Analog inputs image] AIA**: The image of the analog inputs,
- **[Digital Output Map] LOA**: The mapping of the digital outputs and relays,
- **[Analog outputs image] AOA**: The image of the analog outputs ,

The parameters available in this menu are in read-only mode, they cannot be configured.

For more information on the inputs/outputs configuration, refer to the menu in 4 [Input/Output] IO , page 183.

[Digital Input Map] LIA

HMI label	Setting	Factory setting
[Digital Input Map] LIA		–
<p>Access path: [Display] SUP → [I/O Map] IOM → [Digital Input Map] LIA</p> <p>This menu is used to display the state of digital inputs. Use the touch wheel to scroll through the digital inputs:</p> <p>On the Display Terminal, select the digital input to see the function assigned to it. This can be used to verify the compatibility with the input/output assignments.</p> <p>For more information on digital inputs refer to 4.1 [DI3 assignment] L3A 4.2 [DI4 assignment] L4A, page 184.</p>		

[Analog inputs image] AIA

This menu is used to display the state of analog inputs. Use the touch wheel to scroll through the analog inputs:

On the Display Terminal, select the analog input to see the function assigned to it. This can be used to verify the compatibility with the input/output assignments.

For more information on analog inputs refer to 4.5 [AI1 configuration] AI1, page 187.

HMI label	Setting	Factory setting
[AI1] AI1C	–	–
Physical value AI1		
Access path: [Display] MON → [I/O Map] IOM → [Analog inputs image] AIA		
HMI label	Setting	Factory setting
[AI1 assignment] AI1A	–	–
AI1 assignment		
Access path: [Display] MON → [I/O Map] IOM → [Analog inputs image] AIA		
This menu monitors the assignment of terminal AI1/PTC1.		
<ul style="list-style-type: none"> • [No] NO: AI1/PTC1 not assigned • [AQ1] AO1: AI1/PTC1 assigned to analogue output • [Forced local] AIFLOC: AI1/PTC1 assigned to local command channel • [AI1 Th Monitoring] TH1S: AI1/PTC1 assigned to thermal monitoring 		
[AI1 filter] AI1F	0...10 s	0 s
AI1 filter		
Access path: [Display] MON → [I/O Map] IOM → [Analog inputs image] AIA		
Filter set to AI1/PTC1 Terminal. Filters the interferences.		

[Digital Output Map] LOA

HMI label	Setting	Factory setting
[Digital Output Map] LOA	–	–
This menu is used to display the state of digital outputs and relays. Use the touch wheel to scroll through the digital outputs:		
On the Display Terminal, select the digital output to see all the functions that are assigned to it. This can be used to verify the compatibility with the input/output assignments.		
For more information on digital outputs refer to [DQ1 configuration] DO1, page 185.		

[Analog outputs image] AOA

This menu is used to display the state of analog outputs. Use the touch wheel to scroll through the analog outputs:

On the Display Terminal, select the analog output to see all the functions that are assigned to it. This can be used to verify the compatibility with the input/output assignments.

For more information on analog outputs refer to 4.6 [AQ1 configuration] AO1, page 188.

HMI label	Setting	Factory setting
[AQ1] AO1C	–	–
AQ1 physical value		
HMI label	Setting	Factory setting
[AQ1 assignment] AO1	–	–
AQ1 assignment		
This parameter monitors the value of [AQ1 assignment] AO1.		
[AQ1 min Output] UOL1	0...10 V	–
AQ1 minimum output		
This parameter monitors the value of [AQ1 min Output] UOL1.		
[AQ1 max Output] UOH1	0...10 V	–
AQ1 maximum output		
This parameter monitors the value of [AQ1 max Output] UOH1.		
[AQ1 min output] AOL1	0...20 mA	–
AQ1 min output value		
This parameter monitors the value of [AQ1 min output] AOL1.		
[AQ1 max output] AOH1	0...20 mA	–
AQ1 max output value		
This parameter monitors the value of [AQ1 max output] AOH1.		
[Scaling AQ1 Min] ASL1	0...100 %	–
Scaling AQ1 min		
This parameter monitors the value of [Scaling AQ1 Min] ASL1.		
[Scaling AQ1 Max] ASH1	0...100 %	–
Scaling AQ1 max		
This parameter monitors the value of [Scaling AQ1 Max] ASH1.		
[AQ1 Filter] AO1F	0...10 s	–
AQ1 filter		
This parameter monitors the value of [AQ1 Filter] AO1F.		

7.6 [Energy parameters] ENP

Access path: [Display] SUP → [Energy parameters] ENP

About this Menu

This menu provides the parameters to monitor energy consumption.

HMI label	Display	Factory setting
[Acv Elc Out Pwr in kW] <small>EPRW</small>	0...(1) kW	–
Active electrical output power calculated, with the formula $EPRW = ULN \times \sqrt{3} \times LCR \times COS$. (1): Max value depends on soft starter rating.		
[Elc Egy Today] <small>OCT</small>	0...4,294,967,295 kWh	–
Electrical energy consumed today by the motor in kWh.		
[Elc Egy Yesterday] <small>OCY</small>	0...4,294,967,295 kWh	–
Electrical energy consumed yesterday by the motor in kWh.		
[Elc Energy Cons] <small>OC4</small>	0...999 TWh	–
Electrical energy consumed by the motor in TWh.		
[Elc Energy Cons] <small>OC3</small>	0...999 GWh	–
Electrical energy consumed by the motor in GWh.		
[Elc Energy Cons] <small>OC2</small>	0...999 MWh	–
Electrical energy consumed by the motor in MWh.		
[Elc Energy Cons] <small>OC1</small>	0...999 kWh	–
Electrical energy consumed by the motor in kWh.		
[Elc Energy Cons] <small>OC0</small>	0...999 Wh	–
Electrical energy consumed by the motor in Wh.		
[Peak Elec Out Power] <small>MOEP</small>	0...(1) kW	–
Maximum value of electrical power consumed. (1): Max value depends on soft starter rating.		
[Counter Reset] <small>RPR</small>	–	[No] <small>NO</small>
<p>Counter reset</p> <p>Access path: [Display] SUP → [Counter Management] <small>ELT</small></p> <p>Set the parameter to :</p> <ul style="list-style-type: none"> • [No] <small>NO</small>: No counter reset • [Reset Cons] <small>APH</small> to reset the counters of the energy consumption. • [Reset Run Time] <small>RTH</small> to reset the counter displaying how long the motor has been energized. • [Reset Pw On Time] <small>PTH</small> to reset the counter displaying how long the soft start has been powered-on. • [Reset Start Count] <small>NSM</small> to reset the number of motor starts counter. • [Reset Bypass Count] <small>BPCN</small>: Reset bypass counter • [Reset All] <small>ALLC</small>: Reset all counters 		

8 [Diagnostics] DIA

What's in This Chapter

8.1 [Diag. data] DDT.....	220
8.2 [Error history] PFH.....	221
8.3 [Warnings] ALR.....	222

About this menu

This menu provides the error and warning history of the soft starter.



[Diagnostics] DIA menu navigation

8.1 [Diag. data] DDT	8.2 [Error history] PFH	8.3 [Warnings] ALR
[Last Error] LFT [Last Warning] LALR [Error Info (INF6)] INF6 [Cust Supply Diag] CPSF [Service Message] SER [HMI LED diagnostics] HLT [Clear Error History] RFLT	[Last Error 1] DP1 to [Last Error 15] DPF	[Actual Warnings] ALRD [Warn grp 1 definition] A1C to [Warn grp 5 definition] A5C [Warning History] ALH

8.1 [Diag. data] DDT

Access path: [Diagnostics] DIA → [Diag. data] DDT

About this Menu

This menu provides the parameters to display the last warning and last detected error in addition to device data.

HMI label	Setting	Factory setting
[Last Error] LFT	–	–
<p>Last error occurred</p> <p>Access path: [Diagnostics] DIA → [Diag. data] DDT</p> <p>Last error which occurred. The list of error codes is available in the chapter How To Clear the Error Codes?, page 250.</p>		
[Last Warning] LALR	–	–
<p>Last warning</p> <p>Last warning which occurred. The list of warning codes is available in the chapter List of Available Warning Messages.</p>		
[Error Info (INF6)] INF6	–	–
<p>Internal error 6 (Module identification error) information</p> <p>Access path: [Diagnostics] DIA → [Diag. data] DDT</p> <p>This parameter displays the status of the [Error Info (INF6)] INF6 error.</p> <p>For more information about this error, refer to [Internal Error 6].</p>		
[Cust Supply Diag] CPSF		
<p>Customer supply error diagnostic</p> <ul style="list-style-type: none"> • 0x00: No power supply error detected since startup. • 0x11: Overcurrent detected on customer 24V supply. • 0x21: Overvoltage detected on customer 24V supply. • 0x31: Too many short under-voltages detected on customer 24V supply. <p>This parameter can be accessed only if [Cust Supply Error] CPSF error is triggered.</p>		
[Service Message] SER	–	–
<p>Access path: [Diagnostics] DIA → [Diag. data] DDT</p> <p>This menu presents the service message.</p> <p>This service message is defined using [My preferences] MYP → [Customization] CUS → [Service Message] SER menu.</p>		
[HMI LED diagnostics] HLT	–	–
<p>Access path: [Diagnostics] DIA → [Diag. data] DDT</p> <p>This starts a test sequence to verify the states of the LEDs.</p>		
[Clear Error History] RFLT	[No] NO or [Yes] YES	[No] NO
<p>Clear error history</p> <p>Access path: [Diagnostics] DIA → [Diag. data] DDT</p> <ul style="list-style-type: none"> • [No] NO: Do not clear error history • [Yes] YES: Clear error history 		

8.2 [Error history] PFH

About this Menu

Access path: **[Diagnostics]** DIA

This menu shows the 15 last detected errors. Pressing **OK** key on the selected error code in the **[Error history]** PFH list displays the soft starter data recorded when the error has been detected.

Errors are stored and timestamped on the soft starter. This information is displayed only on the Graphic Display Terminal.

NOTE: : Same content for **[Last Error 1]** DP1 to **[Last Error 15]** DPF.

NOTE: How To Clear the Error Code is available in the chapter How To Clear the Error Codes?, page 250.

The following table shows the **[Last Error 1]** DP1:

HMI label	Setting	Factory setting
[Device State] HS1	–	–
HMI status of the error record 1.		
[Last Error 1 Status] EP1	–	–
Status word of the error record 1.		
[ETI state word] IP1	–	–
Extended status word of the error record 1.		
[Cmd word] CMP1	–	–
Command word of the error record 1.		
[Motor current] LCP1	0.1...6553.5 A	–
Current motor value of the error record 1.		
[Run Elapsed time] RTP1	0..65535 h	–
Run time of the error record 1.		
[Motor therm state] THP1	0...300 %	–
Motor thermal state of the error record 1.		
[Command Channel] DCC1	–	–
Channel command active of the error record 1. <ul style="list-style-type: none"> • TER: terminal channel • LCC: Graphic display channel • MDB: Modbus channel • CAN: CanOpen channel • NET: Option board channel • PWS: DTM based commissioning software • NA: Not available 		
[Motor Torque] OTP1	0...255 %	–
Motor torque of the error record 1.		
[Device Thermal State] TSP1	0%...200%	–
Device thermal state of the error record 1.		
[Warn Group Status] AGP1	–	–
Warning group status of the error record 1.		

8.3 [Warnings] ALR

Access path: [Diagnostics] DIA → [Warnings] ALR

About this Menu

This menu presents the current warnings and warning history. The list of warning codes is available in the chapter Warning Messages, page 252.

HMI label	Setting	Factory setting
[Actual Warnings] ALRD	—	—
<p>List of current warnings.</p> <p>If warning is active and not in warning group, only ✓ is displayed:</p> <div style="display: flex; justify-content: space-around;"> <div style="border: 1px solid black; padding: 5px; width: 45%;"> <p>RDY 0.0A Term 18:10</p> <p>Warnings</p> <ul style="list-style-type: none"> Actual Warnings ✓ Warn grp 1 definition Warn grp 2 definition Warn grp 3 definition Warn grp 4 definition <p>DiagData Errors Wam</p> </div> <div style="border: 1px solid black; padding: 5px; width: 45%;"> <p>RDY 0.0A Term 17:58</p> <p>Actual Warnings</p> <ul style="list-style-type: none"> Errors Inhibited Warn </div> </div> <p>If warning is active and in warning group ✓ and  are displayed:</p> <div style="display: flex; justify-content: space-around;"> <div style="border: 1px solid black; padding: 5px; width: 30%;"> <p>RDY 0.0A Term 17:58</p> <p>Warn grp 1 definition</p> <ul style="list-style-type: none"> Modbus Com Warn <input type="checkbox"/> Fieldbus Com Warn <input type="checkbox"/> CANopen Com Warn <input type="checkbox"/> Errors Inhibited Warn <input checked="" type="checkbox"/> Temp Sens A11 Warn <input type="checkbox"/> </div> <div style="border: 1px solid black; padding: 5px; width: 30%;"> <p>RDY 0.0A Term 18:07</p> <p>Warnings</p> <ul style="list-style-type: none"> Actual Warnings ✓ Warn grp 1 definition Warn grp 2 definition Warn grp 3 definition Warn grp 4 definition <p>DiagData Errors Wam</p> </div> <div style="border: 1px solid black; padding: 5px; width: 30%;"> <p>RDY 0.0A Term 17:58</p> <p>Actual Warnings</p> <ul style="list-style-type: none"> Warning Grp 1 Errors Inhibited Warn </div> </div>		
[Warn grp 1 definition] A1C to [Warn grp 5 definition] A5C	—	—
<p>The following submenus groups the warnings into 1 to 5 groups, each of which can be assigned to a relay or a digital output for remote signalling.</p> <p>When one or several warning(s) selected in a group occur(s), this warning group is activated.</p>		
[Warning History] ALH	—	—
<p>This menu presents the warning history (15 past warnings).</p> <p>Warnings are stored and timestamped on the soft starter. This information is visible only on the Graphic Display Terminal.</p>		

9 [Device Management] DMT

What's in This Chapter

9.1 [Device Name] PAN	224
9.2 [Identification] OID	224
9.3 [Transfer config file] TCF	225
9.4 [Factory settings] FCS	226
9.5 [Backup/Restore] BRDV	228
9.6 [Cybersecurity] CYBS	229
9.7 [Date & Time] DTO	232
9.8 [Firmware update] FWUP	234
9.11 [Simulation mode] SIMU	237
9.12 [Product restart] RP	238

About This Menu

This menu provides the parameters to manage the soft starter functioning and firmware update.



[Device Management] DMT menu navigation

9.1 [Device Name] PAN	9.5 [Backup/Restore] BRDV	9.7 [Date & Time] DTO
9.2 [Identification] OID	[Save backup image] SBK	[Set Date/Time] DTO
9.3 [Transfer config file] TCF	[Load backup image] OBK	[Time Format] TIMF
[Copy To The Device] OPF	[Clear device] CLR	[Date Format] DATF
[Copy From Device] SAF	9.6 [Cybersecurity] CYBS	[Battery Level] EBAL
9.4 [Factory settings] FCS	[Access control] CSAC	[Last Power Off Time] MTHT
[Config. Source] FCSI	[Mdb SL User Auth.] SCPM	9.8 [Firmware update] FWUP
[Parameter group list] FRY	[Eth Opt User Auth.] SCPO	[Version Info] VIF
[All] ALL	[EnableOptWeb] EWE	[Check For Update] NFW
[Device Configuration] DRM	[Load security policy] OSE	[Available Packages] APK
[Motor param] MOT	[Save security policy] SSE	9.11 [Simulation mode] SIMU
[Comm. menu] COM	[Reset Password] SRPW	9.12 [Product restart] RP
[Display config.] DIS		
[Fieldbus Module] NET		
[Go to Factory Settings] GFS		
[Save Configuration] SCSI		
[Clear device] CLR		

9.1 [Device Name] PAN

Access path: [Device Management] DMT → [Device Name] PAN

About this Menu

This menu provides the parameter to edit the [Device Name] PAN.

HMI label	Setting	Factory setting
[Device Name] PAN	–	–
<p>Access path: [Device Management] DMT → [Device Name] PAN</p> <p>The FDR (Fast Device Replacement) service is based on identification of the device by a “Device Name” and accessible via Ethernet.</p> <p>In the case of this device, this is represented by the [Device Name] PAN parameter. Check that all the network devices have different “Device Names”.</p>		

9.2 [Identification] OID

Access path: [Device Management] DMT → [Identification] OID

About this Parameter

This parameter displays the identification numbers of the soft starter.

HMI label	Setting	Factory setting
[Identification] OID	–	–
<p>Access path: [Device Management] DMT → [Identification] OID</p> <p>This is a read-only menu that cannot be configured. It displays the following information:</p> <ul style="list-style-type: none"> • Device name, if defined • Device reference • Power rating • Voltage rating • Device version • Firmware security state • Design version • Device serial number • Fieldbus module identification if plugged, with name, reference, version and serial number • Display terminal identification, with name, version and serial number 		

9.3 [Transfer config file] TCF

Access path: [Device Management] DMT → [Transfer config file] TCF

About this Menu

This menu provides the parameters to manage the device configuration files.

NOTE: Refers to the chapter Cybersecurity, page 229 for the Upload and the Download rights.

HMI label	Setting	Factory setting
[Copy To The Device] OPF	–	–
Access path: [Device Management] DMT → [Transfer config file] TCF This allows to select a device configuration previously stored in the Display Terminal and apply it to the soft starter. The device needs to be restarted after a configuration file transfer.		
[Copy From Device] SAF	–	–
Access path: [Device Management] DMT → [Transfer config file] TCF This allows to store the actual soft starter configuration into the Display Terminal.		
Display Terminal	Number of configuration files store up	File name configurable
Plain text	1	No
Graphic	16	Yes

9.4 [Factory settings] FCS

Access path: [Device Management] DMT → [Factory settings] FCS

About this Menu

This Menu give access to the parameters :

- To restore your device to a customer parameters set;
- To select the parameters impacted by the saved/restored configuration;
- To restore your device fully to the state where it was made out in the factory;
- To save your device to a customer parameters set.

NOTE: .The [Parameter group list] FRY parameter has an impact on the saved/restored configuration.

NOTE: This Menu acts on Device Configuration only, while Cybersecurity Profile and Device Image stay untouched.

HMI label	Setting	Factory setting
[Config. Source] FCSI	–	[Macro Config] INI
<p>Source configuration</p> <p>Access path: [Device Management] DMT → [Factory settings] FCS</p> <p>This parameter allows to select the configuration to restore a customer parameters set.</p> <ul style="list-style-type: none"> • [Macro Config] INI for the factory settings parameters set. • [Config 1] CFG1 for the customer parameters set 1. • [Config 2] CFG2 for the customer parameters set 2. • [Config 3] CFG3 for the customer parameters set 3. 		
[Parameter group list] FRY	–	–
<p>Access path: [Device Management] DMT → [Factory settings] FCS</p> <p>Selection of menus to be loaded.</p> <ul style="list-style-type: none"> • [All] ALL : All parameters in all menus (except cybersecurity parameters). • [Device Configuration] DRM : Load [Complete settings] CST menu. • [Motor param] MOT : Load [Motor parameters] MMO menu. • [Comm. menu] COM : Load embedded fieldbus menu. • [Display config.] DIS : Load display menu. • [Fieldbus Module] NET : Load option fieldbus menu. <p>NOTE: In factory configuration and after a return to "factory settings", [Parameter group list] FRY will be empty.</p>		
[Go to Factory Settings] GFS	–	–
<p>Access path: [Device Management] DMT → [Factory settings] FCS</p> <div style="border: 1px solid black; padding: 10px; text-align: center;"> <p>▲ WARNING</p> <p>UNANTICIPATED EQUIPMENT OPERATION</p> <ul style="list-style-type: none"> • Verify that restoring the factory settings or modifying the configuration is compatible with the type of wiring used. • If you are recalling a stored configuration, perform a comprehensive commissioning test to verify correct operation. <p>Failure to follow these instructions can result in death, serious injury, or equipment damage.</p> </div>		



HMI label	Setting	Factory setting
It is only possible to revert to the factory settings if at least one group of parameters has previously been selected.		
[Save Configuration] SCSI	–	[No] NO
<p>Save configuration</p> <p>Access path: [Device Management] DMT → [Factory settings] FCS</p> <p>This parameter allows to select the configuration to save:</p> <ul style="list-style-type: none"> • [No] NO: operation completed • [Config 1] STR1 to store the customer parameters set 1. • [Config 2] STR2 to store the customer parameters set 2. • [Config 3] STR3 to store the customer parameters set 3. <p>To apply the saving, hold down the OK button until returned to the previous menu.</p> <p>The parameter changes back to [No] NO as soon as the operation is completed.</p>		
[Clear device] CLR 	–	–
<p>Access path: [Device Management] DMT → [Factory settings] FCS</p> <p>This parameter can be used to restore the product configuration and the cybersecurity policy into the initial setup configuration.</p>		

9.5 [Backup/Restore] BRDV

Access path: [Device Management] DMT → [Backup/Restore] BRDV 

About this Menu

This menu provides the parameters to backup and restore the product configuration and the cybersecurity policy.

HMI label	Setting	Factory setting
[Save backup image] SBK 	–	–
Access path: [Device Management] DMT → [Backup/Restore] BRDV This parameter can be used to save the actual product configuration and cybersecurity policy into the Display Terminal.		
Display Terminal	Number of configuration files store up	File name configurable
Plain text	1	No
Graphic	16	Yes
[Load backup image] OBK 	–	–
Access path: [Device Management] DMT → [Backup/Restore] BRDV This parameter can be used to select a product configuration and cybersecurity policy configuration previously stored in the Display Terminal and apply it to the soft starter.		
[Clear device] CLR 	–	–
Access path: [Device Management] DMT → [Backup/Restore] BRDV This parameter can be used to restore the product configuration and the cybersecurity policy into the initial setup configuration.		

9.6 [Cybersecurity] CYBS

Access path: [Device Management] DMT → [Cybersecurity] CYBS

About this Menu

This menu provides the parameters to configure the cybersecurity of the soft starter.

[Access control] CSAC

This sub-menu enable the user authentication feature for the embedded Modbus, Ethernet fieldbus module and the webserver.

From [No] to [Yes], the change is applied at the next frame received.

From [Yes] to [No], the change is applied when the record session and associated sockets are closed.

HMI label	Setting	Factory setting
[Mdb SL User Auth.] SCPM	[No] NO or [Yes] YES	[No] NO
<p>Modbus SL user authentication</p> <p>Access path: [Device Management] DMT → [Cybersecurity] CYBS → [Access control] CSAC</p> <p>This parameter is used to enable or disable the user authentication feature for the embedded Modbus.</p> <ul style="list-style-type: none"> • [No] NO: User authentication disabled. Connection to PC software tools provided by Schneider Electric (such as SoMove FDT / DTM) with the embedded Modbus is open. • [Yes] YES: Connection to PC software tools provided by Schneider Electric (such as SoMove FDT / DTM) with the embedded Modbus is locked by a password. <p>For more information refer to the ATS480 Embedded Modbus Manual (NNZ85539 (English)) Disabling this feature, no credentials will be required to access your process or machine. This setting is saved with the configuration and will be active if a configuration is loaded or copied.</p>		
<p>⚠ WARNING</p>		
<p>UNAUTHENTICATED ACCESS AND MACHINE OPERATION</p> <p>Do not disable the feature if your machine or process is accessible to unauthorized personnel either directly or via a network.</p> <p>Failure to follow these instructions can result in death, serious injury, or equipment damage.</p>		

HMI label	Setting	Factory setting
[Eth Opt User Auth.] SCPO	[No] NO or [Yes] YES	[No] NO
<p>Ethernet option user authentication</p> <p>Access path: [Device Management] DMT → [Cybersecurity] CYBS → [Access control] CSAC</p> <p>This parameter is used to enable or disable the user authentication feature for the Ethernet fieldbus module.</p> <ul style="list-style-type: none"> • [No] NO: User authentication disabled. Connection to PC software tools provided by Schneider Electric (such as SoMove FDT / DTM) with the Ethernet fieldbus module is open. • [Yes] YES: Connection to PC software tools provided by Schneider Electric (such as SoMove FDT / DTM) with the Ethernet fieldbus module is locked by a password. <p>This parameter does not affect the security of the webserver. To harden webserver security, you must set the security level via the webserver.</p> <p>This parameter is visible only if an Ethernet fieldbus module is plugged in the soft starter.</p> <p>For more information refer to the ATS480 Ethernet IP Modbus TCP Manual VW3A3720 (NNZ85540 (English)). Disabling this feature, no credentials will be required to access your process or machine. This setting is saved with the configuration and will be active if a configuration is loaded or copied.</p> <div style="border: 1px solid black; padding: 10px; text-align: center;"> <p>⚠ WARNING</p> <p>UNAUTHENTICATED ACCESS AND MACHINE OPERATION</p> <p>Do not disable the feature if your machine or process is accessible to unauthorized personnel either directly or via a network.</p> <p>Failure to follow these instructions can result in death, serious injury, or equipment damage.</p> </div>		
[Enable Webserver] EWE	[No] NO or [Yes] YES	[Yes] YES
<p>Enable Webserver</p> <p>Access path: [Device Management] DMT → [Cybersecurity] CYBS → [Access control] CSAC</p> <p>This parameter is used to enable or disable the access to the webserver.</p> <ul style="list-style-type: none"> • [No] NO: Connection to the webserver is disabled. • [Yes] YES: Connection to the webserver is enabled. <p>This parameter does not affect the security of the webserver. To harden webserver security, you must set the security level via the webserver.</p> <p>This parameter is visible only if an Ethernet fieldbus module is plugged in the soft starter.</p> <p>For more information refer to the ATS480 Ethernet IP Modbus TCP Manual VW3A3720 (NNZ85540 (English)).</p>		

HMI label	Setting	Factory setting
[Load security policy] OSE	–	–
Access path: [Device Management] DMT → [Cybersecurity] CYBS This parameter can be used to select a cybersecurity policy configuration previously stored in the Display Terminal and apply it to the soft starter.		
[Save security policy] SSE	–	–
Access path: [Device Management] DMT → [Cybersecurity] CYBS This parameter can be used to save the actual cybersecurity policy into the Display Terminal.		
Display Terminal	Number of configuration files store up	File name configurable
Plain Text	1	No
Graphic	16	Yes
[Reset Password] SRPW	–	[No] NO
Access path: [Device Management] DMT → [Cybersecurity] CYBS If the [Reset Password] SRPW is set to: <ul style="list-style-type: none"> • [No] NO: the password is not reset. • [Yes] YES: the password is reset. 		
[Default Password] SDPW	–	–
This parameter displays the default password.		

9.7 [Date & Time] DTO

Access path: [Device Management] DMT → [Date & Time] DTO

About this Menu

This menu provides the parameters to set date and time. This information is used for the time stamping of all logged data.

HMI label	Setting	Factory setting
[Set Date/Time] DTO	–	–
<p>Access path: [Device Management] DMT → [Date & Time] DTO</p> <p>If a time server is connected over Ethernet and configured in the webserver, date and time data are updated automatically according to the configuration.</p> <p>Date and time information should be available (time server available and configured, or Display Terminal plugged) at soft starter power up to enable the time stamping of the logged data.</p> <p>Setting [Set Date/Time] DTO gives access to the parameter [Time Zone] TOP, which can be used to set the offset between reference time and local time (by 15mn step).</p>		
[Time Format] TIMF	–	[24h] 24
<p>Access path: [Device Management] DMT → [Date & Time] DTO</p> <p>This parameter can be used to choose a time format to display on log file:</p> <ul style="list-style-type: none"> • [24h] 24: Hour is displayed in a 24h format. • [12h] 12: Hour is displayed in a 12h format. 		
[Date Format] DATF	–	[yyyy/mm/dd] Y4M2D2
<p>Access path: [Device Management] DMT → [Date & Time] DTO</p> <p>This parameter can be used to choose a date format to display on log file:</p> <ul style="list-style-type: none"> • [yyyy/mm/dd] Y4M2D2: Date is displayed as yyyy/mm/dd. • [dd/mm/yyyy] D2M2Y4: Date is displayed as dd/mm/yyyy. • [mm/dd/yyyy] M2D2Y4: Date is displayed as mm/dd/yyyy. • [dd/mm/yy] D2M2Y2: Date is displayed as dd/mm/yy. • [dd/mm] D2M2: Date is displayed as dd/mm. 		

HMI label	Setting	Factory setting
[Battery Level] EBAL	0...100%	–
<p>Access path: [Device Management] DMT → [Date & Time] DTO</p> <p>Gives embedded battery level (updated by steps of 25%):</p> <ul style="list-style-type: none"> • 0%: Embedded battery is extremely low. • 25%: Embedded battery is low. • 50%-75%: Embedded battery is correct. • 100%: Embedded battery is full. • [No Battery] NOBAT : Embedded battery is flat, damaged or not present <p>NOTE: In case of battery is empty or not present:</p> <ul style="list-style-type: none"> • The device has not yet been powered off: the device runs normally, showing a warning inviting the user to change it. If the battery is replaced, time and date are lost. • The device has already been powered off once: the device runs normally; time and date are not valid. Warning for changing the battery is present. If the battery is replaced and Ethernet is not connected, time and date need to be set manually. • Motor thermal monitoring: in case of powering off, the device considers the last saved thermal state. <p>NOTE: In case of CL1/CL2 or 24V not present, if the battery is replaced, time and date are lost. The user will have to set time and date at next power ON.</p> <p>NOTE: Logged data will not be time stamped if battery level reached 0%.</p>		

9.8 [Firmware update] FWUP

Access path: [Device Management] DMT → [Firmware update] FWUP



About this Menu

[Firmware update] FWUP  provides the parameters to update the firmware of the soft starter.

NOTE: update the labels of the Plain Text Display Terminal too.

Update the firmware directly via the device or using Ecostruxure Automation Device Maintenance (EADM). To use EADM refer to its manual on se.com.

For more information about [Firmware update] contact your local Schneider Electric Services.

HMI label	Setting	Factory setting
[Version Info] VIF 	–	–
Access path: [Device Management] DMT → [Firmware update] FWUP This parameter gives the version of the packages applied at the latest firmware update.		
[Check For Update] NEW 	–	–
Access path: [Device Management] DMT → [Firmware update] FWUP This parameter is used to know if a new firmware version is available for the device, the plugged fieldbus modules or the plugged Plain Text Display Terminal. Note: The update can take more than 10 minutes.		
[Available Packages] APK 		
Access path: [Device Management] DMT → [Firmware update] FWUP This parameter is used to know all available firmware versions, new or legacy, for the device, the plugged fieldbus modules or the plugged Plain Text Display Terminal. It includes legacy, current and new firmware versions. Note: The update can take more than 10 minutes.		

Preparing soft starter for a firmware update

NOTE: Make sure that the latest version of the firmware and of the user manual are used.

NOTE: Make sure that the CL1/CL2 ports are supplied.

Install on your PC either :

- EcoStruxure Automation Device Maintenance.
- Or SoMove and the DTM.

To download the required DTM refer to ATS480: DTM, page 14.

To download SoMove go to SoMove FDT.

To download Control Expert and the required DTM, refer to Related Documents, page 14.

Connect the device to the PC. Use one of the following serial communication cables:

- VW3A8127 for Modbus VP12S connection.
- RJ45 cable for ethernet connection (if there is an ethernet option plugged for ATS480).

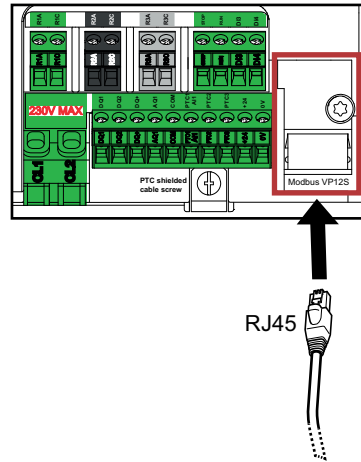

Download Altivar Soft Starter firmwares.

Proceed a firmware update of the device

NOTE: with ethernet or profinet, the transfer & applied are done without additional action from user if i remember correctly.

Once the device is recognized or connect to the PC (using EADM / SoMove), the firmware is done in 3 steps:

Step	Actions
1	<p>Transfer: a firmware is transferred from the PC to the soft starter using the selected fieldbus.</p> <p>During this phase the soft starter remains operational.</p>
2	<p>Once the transfer is completed, the firmware package is accessible from [Available Packages] parameter.</p> <p>Follow this Access path: [Device Management] → [Firmware update]</p> <p>This parameter is used to know all available firmware versions, new or legacy, for the device, the plugged fieldbus modules or the plugged Plain Text Display Terminal. It includes legacy, current and new firmware versions.</p> <p>NOTE: The update can take up to 20 minutes.</p> <p>NOTE: If the firmware update fails, do a power cycle before retrying the action.</p>
3	<p>Select one of available packages and apply it.</p> <div style="border: 1px solid black; padding: 10px; margin: 10px 0;"> <p style="text-align: center;">⚠ WARNING</p> <p>UNANTICIPATED EQUIPMENT OPERATION</p> <p>Verify that the device is stopped (RDY or NST state). The device will not be operational until the firmware update procedure is completed.</p> <p>The relays, the analog and digital outputs may change state during the firmware update process. Depending on the wiring and the configuration of the device, this may result in immediate and unanticipated operation.</p> <p>Before applying the data previously transferred to the device or its option module:</p> <ul style="list-style-type: none"> • Verify that the automation application controlling the device is stopped and that the device and its inputs and outputs, including communication channel(s) to external controller(s), cannot interact with your industrial process, and does not result in unsafe conditions. • Verify that the parameter [Disable Error Detect] INH is not assigned. <p>In case of doubt, disconnect all analog and digital inputs and outputs of the device before applying the firmware update.</p> <p>Failure to follow these instructions can result in death, serious injury, or equipment damage.</p> </div> <p>During this phase, the soft starter is in a [Firmware Update] state. No operations are permitted.</p> <p>Depending on the software used, Transfer and Application can be:</p> <ul style="list-style-type: none"> • Manual: the user confirms a transfer and confirms an application in front of the device using the display terminal / EADM / SoMove. • Automatic: the user confirms a transfer and apply, which means once the firmware is transferred, it is automatically applied to the soft starter

A "How to video" is available on [se.com](https://www.se.com). Refer to the Related Documents.

9.11 [Simulation mode] SIMU

Access path: [Device Management] DMT → [Simulation mode] SIMU

About this Menu

[Simulation mode] SIMU  menu provides the parameters to set the simulation mode.

This menu is visible only if the demonstration mode is activated during the initial setup. For more information about the initial setup refer to *First Power-Up*, page 100.

This menu can be used to demonstrate the features of the soft starter for trainings, commercial events or tests on customer installations. The presence of the motor and the mains supply are simulated, only the control supply (CL1/CL2) is required to use this functionality.

HMI label	Setting	Factory setting
[Simu Mode Assign] SIMM	–	[No] NO
Simulation mode assignment Access path: [Device Management] DMT → [Simulation mode] SIMU Activation of simulation mode. <ul style="list-style-type: none"> [No] NO: Simulation mode not active. [Standard] STD: Standard simulation mode active. 		
[Simu Quadratic Load] SIMQ	0...200%	100
Simulated quadratic load Access path: [Device Management] DMT → [Simulation mode] SIMU Quadratic load torque adjustment.		

9.12 [Product restart] RP

HMI label	Setting	Factory setting
[Product restart] RP	–	[Not Assigned] NO
<p>Product restart</p> <p>Access path: [Device Management] DMT</p> <p>Manually restarts the device via the HMI. Press and hold the OK button on the display terminal for 2 seconds to restart the device.</p> <p>This parameter is automatically set to [Not Assigned] NO after restart.</p> <ul style="list-style-type: none"> • [Not Assigned] NO: No restart • [Yes] YES: Restart the device <p>The Restart function performs a Fault Reset and then restarts the device. During this Restart procedure, the device goes through the same steps as if it had been switched off and on again. Depending on the wiring and the configuration of the device, this may result in immediate and unanticipated operation.</p>		
<p>▲ WARNING</p>		
<p>UNANTICIPATED EQUIPMENT OPERATION</p> <p>The Restart function performs a Fault Reset and restarts the device.</p> <ul style="list-style-type: none"> • Verify that activating this function does not result in unsafe conditions. <p>Failure to follow these instructions can result in death, serious injury, or equipment damage.</p>		

10 [My preferences] MYP

What's in This Chapter

10.1 [Language] LNG	240
10.2 [Parameter access] PAC	241
10.3 [Customization] CUS	242
10.4 [LCD settings] CNL	244
10.5 [QR code] QCC	245

About the Menu

This menu provides the parameters to manage the display terminal settings and parameters access.



[My preferences] MYP menu navigation

10.1 [Language] LNG
10.2 [Parameter access] PAC
[Access Level] LAC

10.3 [Customization] CUS
[Stop Key Enable] PST
[HMI L/R cmd] BMP
[Display screen type] MSC
[Display value type] MDT
[Parameter Selection] MPC
[Param. Bar Select] PBS
[Service Message] SER

10.4 [LCD settings] CNL
[Screen Contrast] CST
[Standby] SBY
[Display Terminal locked] KLCK
[Red Backlight] BCKL
10.5 [QR code] QCC

10.1 [Language] LNG

Access path: [My preferences] MYP → [Language] LNG

This parameter presents the possible language settings.

HMI label	Setting	Factory setting
[Language] LNG	–	English
Access path: [My preferences] MYP		
This parameter can be used to select the Display Terminal language.		

Plain Text Display Terminal Languages Update

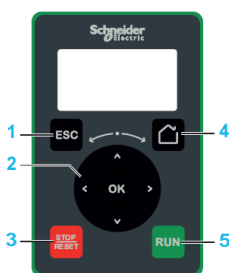

The Plain Text Display Terminal (VW3A1113) language files can be updated.

The transfer of the languages files is done with the transfer of the soft starter firmware package.

The application of the label package must be done manually when the display terminal is plugged to the soft starter ATS480 and the soft starter is powered (the application of the soft starter package and the application of the languages files are done separately).

Use one of the following serial communication cables:

- TCSMCNAM3M002P
- VW3A8127

Graphic Display Terminal Languages Update

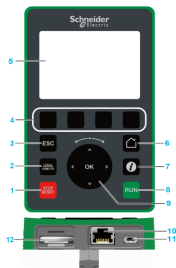

The Graphic Display Terminal (VW3A1111) language files can be updated.

Download the latest version of language files here: [Languages_Drives_VW3A1111](#)

The following table describes the procedure to update the language files of the Graphic Display Terminal:

Action	Step
1	Download the latest version of language files here: Languages_Drives_VW3A1111
2	Save the downloaded file on your computer.
3	Unzip the file and follow the instructions of the ReadMe text file.

10.2 [Parameter access] PAC

Access path: [My preferences] MYP → [Parameter access] PAC

About this Menu

This menu provides the parameters to set access level, set parameters access restriction, channels access restriction and to display only the active parameters.

HMI label	Setting	Factory setting
[Access Level] LAC	–	[Standard] STD
<p>Access level</p> <p>Access path: [My preferences] MYP → [Parameter access] PAC</p> <ul style="list-style-type: none"> • [Basic] BAS gives access to all submenus and parameters of the following menus: <ul style="list-style-type: none"> ◦ [Simply Start] SYS ◦ [Monitoring] PROT ◦ [Input/Output] IO ◦ [Display] MON ◦ [Diagnostics] DIA ◦ [Device Management] DMT except [Product restart] RP parameter • [Standard] STD gives access to all menus. • [Expert] EPR are visible: <ul style="list-style-type: none"> ◦ The following parameters: <ul style="list-style-type: none"> – [Gamma Sync Error] TSC – [Torque Limit] TLI – [Stator Loss Comp] LSC – [Cmd channel 2] CD2 – [Copy Ch1-Ch2] COP – [Disable Error Detect] INH – [R3 Active at] R3S – [R3 Holding time] R3H – [DQ1 Active at] DO1S – [DQ2 Active at] DO2S – [Clear device] CLR – [Term word order] TWO – [Command Switching] CCS – [Cmd channel 2] CD2 – [Copy Ch1-Ch2] COP ◦ The following menus: <ul style="list-style-type: none"> – [AI1 configuration] AI1 – [Backup/Restore] BRDV – [Firmware update] FWUP 		

10.3 [Customization] CUS

Access path: [My preferences] MYP → [Customization] CUS

About the Menu

This menu provides the parameters to customize the [My menu] MYMN and the [Display screen type] MSC.

HMI label	Setting	Factory setting
[Stop Key Enable] PST	[Stop Key Priority] YES or [Stop Key No Priority] NO	[Stop Key Priority] YES
<p>Stop key enable</p> <p>Access path: [My preferences] MYP → [Customization] CUS</p> <p>This parameter set the priority for the STOP / RESET button on the display terminal.</p> <ul style="list-style-type: none"> • [Stop Key Priority] YES: Enable the STOP / RESET button • [Stop Key No Priority] NO: Disable the STOP / RESET button if it is not the active channel set in [Command channel] CCP <p>Setting this function to [Stop Key No Priority] NO disables the Stop keys of the display terminals if the command channel set in the menu [Command channel] CMDC is not set to [HMI] LCC.</p>		
<h2>⚠ WARNING</h2>		
<p>LOSS OF CONTROL</p> <p>Only set this parameter to [Stop Key No Priority] NO if you have implemented appropriate alternative stop functions.</p> <p>Failure to follow these instructions can result in death, serious injury, or equipment damage.</p>		
[HMI L/R cmd] BMP	–	[Disabled] DIS
<p>HMI local/remote command</p> <p>Access path: [My preferences] MYP → [Customization] CUS</p> <ul style="list-style-type: none"> • [Stop On Switching] STOP: Change the control channel to the display terminal and apply a Stop order according to [Type of stop] STT. • [Bumpless] BUMP: Change the control channel to the display terminal without applying a Stop order. • [Disabled] DIS: Disable the Local / Remote display terminal key. <p>This parameter is visible if [Control Mode] CHCF is set to [Standard Profile] STD.</p> <p>[HMI L/R cmd] BMP is forced to [Disabled] DIS if [Control Mode] CHCF is set to [SE8 Profile] SE8 or [Cascade] CSC is set to [Yes] YES.</p>		
[Param. Bar Select] PBS	–	–
<p>Access path: [My preferences] MYP → [Customization] CUS</p> <p>This view can be used to select the parameters to display on the top line of the Display Terminal screen.</p> <p>The Plain Text Display Terminal can display only the first parameter. A Graphic Display Terminal can display both parameters.</p>		
[Service Message] SER	–	–
<p>Access path: [My preferences] MYP → [Customization] CUS</p> <p>This menu can be used to define up to 5 user-defined service messages.</p> <p>This defined message is displayed in [Diagnostics] DIA → [Diag. data] DDT → [Service Message] SER submenu.</p>		

[Display screen type] MSC

About This Menu

These parameters can be used to select the type of display for the default screen.

HMI label	Setting	Factory setting
[Display value type] MDT	-	[Digital] DEC

HMI displayed value type

Access path: [My preferences] MYP → [Customization] CUS → [Display screen type] MSC

These parameters can be used to:

- **[Digital] DEC** Digital values (up to 2 parameters can be selected).



- **[Bar graph] BAR** Bar graph (up to 2 parameters can be selected and not all listed parameters are selectable).

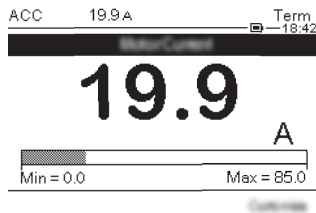

- **[List] LIST** List of values (up to 5 parameters can be selected).

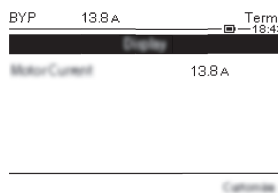

- **[Vu Meter] VUMET** Vu meter (only with the Graphical Display Terminal, 1 parameter can be selected and not all listed parameters are selectable).

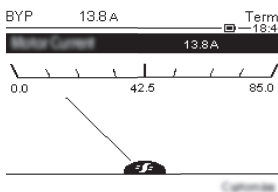

HMI label	Setting	Factory setting
[Parameter Selection] MPC	–	–
Access path: [My preferences] MYP → [Customization] CUS → [Display screen type] MSC Customized selection. This view can be used to select the parameters to display on the default screen. The maximum number of selected parameters and the selectable parameters depend on [Display value type] MDT.		

[Service Message] SER

HMI label	Setting	Factory setting
[Service Message] SER	–	–
Access path: [My preferences] MYP → [Customization] CUS → [Service Message] SER This parameter define the service message to display.		

10.4 [LCD settings] CNL

Access path: [My preferences] MYP → [LCD settings] CNL

About this Menu

This menu provides the parameters to manage the display terminal related parameters.

HMI label	Setting	Factory setting
[Screen Contrast] CST	0...100%	50%
Access path: [My preferences] MYP → [LCD settings] CNL Screen contrast setting.		
[Standby] SBY	NO...10 min	1 min
Access path: [My preferences] MYP → [LCD settings] CNL Automatic backlight OFF time NOTE: Disabling the automatic standby function of the display terminal backlight will reduce the backlight service life.		
[Display Terminal locked] KLCK	NO...10 min	5 min
Access path: [My preferences] MYP → [LCD settings] CNL Display Terminal key locked. Press ESC and Home keys to Lock manually & unlock the Graphic Display Terminal keys. The Stop key remains active when the Graphic Display Terminal is locked.		
[Red Backlight] BCKL	–	[Yes] YES
Access path: [My preferences] MYP → [LCD settings] CNL Graphic Display Terminal only. Display Terminal red backlight function disabled in case of an error triggered. [No] NO: Red backlight disabled [Yes] YES: Red backlight enabled		

10.5 [QR code] QCC

HMI label	Setting	Factory setting
[QR code] QCC	–	–
<p>Access path: [My preferences] MYP → [QR code] QCC</p> <p>Scan of this QR code brings to a landing page on Internet with the information on:</p> <ul style="list-style-type: none">• Technical product datasheet,• Link for Schneider Electric App available for services. <p>Available only for the Graphic Display Terminal.</p>		

Functions Compatibility Table

The choice of application functions can be limited by the incompatibility between certain functions. The functions that are not listed in the table next page are not incompatible with any other functions.

1. Only warnings are managed, error detection is inhibited.
2. **[Cascade Activation]** is available only if:
 - **[Cmd channel 1]** is set to **[Terminal]** and **[Command Switching]** is set to **[Cmd channel 1]**.
 - Set **[HMI L/R cmd]** is set to **[Disabled]** and **[Forced Local Chan]** is set to **[Terminal]**.
3. Explicit command switching is not compatible with **[Control Mode]** set to **[SE8 Profile]**.
4. During the **[Small Motor Test]**, **[Phase Loss Monit]** is inhibited and its previous value is recovered when **[Small Motor Test]** is set back to Off.
5. During **[Small Motor Test]**, only **[Voltage Control]** type of motor control is active. The previous motor control is reactivated when **[Small Motor Test]** is Off again.
6. The type of stop is set by **[Type of stop]**. Only one type of stop can be active at any time.
7. The control mode is set by **[Control Mode]**. Only one type of control can be active at any time.
8. **[Braking]** is not compatible with **[Inside Delta]**. When **[Inside Delta]** is set to **[Yes]**, **[Braking]** is deactivated and **[Type of stop]** is forced to **[Deceleration]**.
9. When **[Cascade Activation]** is set to **[Yes]**, the thermal protection of the motor is deactivated.
10. To set **[Cascade Activation]** to **[Yes]**, **[R1 Assignment]** must be set to **[Isolating Relay]**.
11. To assign a digital input to **[Device Lock]**, **[Mains Contactor]** must be set to **[R3]**.

	The functions A and B are compatibles.
X	The function A cannot be activated. Function A is incompatible with the function B .
O	The function A can be activated but deactivate the function B . Function A has priority.
D	The function A can be activated only if the function B is already activated.
NA	Not applicable. The function A cannot be activated because it is incompatible with a function that is mandatory for function B .
	Not reachable.

Examples on how to read this table:

- Activating **[Deceleration]** deactivate **[Braking]**.
- Impossible to activate **[Braking]** when **[Inside Delta]** is already activated.
- **[Device Lock]** can be activated only if **[Mains Contactor]** is already activated.

Function B (already activated) →	Stop in deceleration	Dynamic braking stop	Forced freewheel stop	Motor thermal protection	Output phase loss	Delta winding	Small motor test	Cascade	Preheating	Line contactor	Device locking	Isolating relay	Overload detection	Underload detection	Terminal might not be active channel	Voltage control	Torque control	2-wire control
Function A (to be activated) ↓	Stop in deceleration	Dynamic braking stop	Forced freewheel stop	Motor thermal protection	Output phase loss	Delta winding	Small motor test	Cascade	Preheating	Line contactor	Device locking	Isolating relay	Overload detection	Underload detection	Terminal might not be active channel	Voltage control	Torque control	2-wire control
[Deceleration] _D		D (6)																
[Braking] _B	D (6)					X (8)												
[Freewheel Assign] _{FESA}								X										
[Motor Class] _{THP}								X (9)										
[Phase Loss Monit] _{PHP}							X (4)											
[Inside Delta] _{DLT}		D (8)						X	X									
[Small Motor Test] _{SST}					D (4)													D (5)
[Cascade Activation] _{CSC}			X	D (9)		X			X	NA	NA	O (10)	D (1)	D (1)	X			
[Preheating Assign] _{PRHA}						X		X										X
[Mains Contactor] _{LLC}								NA				X						
[Device Lock] _{LES}								NA		O (11)		NA						
[Isolating Relay] _{ISOL}										X	NA							
[Overload Activation] _{ODLA}						X (1)												
[Underload Activation] _{UDLA}						X (1)												
Terminal might not be active channel (3)						X												
[Voltage Control] _{VC}																		D (7)
[Torque Control] _{TC}					X (5)											D (4)		
2-wire control									X									

Diagnostics and Troubleshooting

What's in This Part

Troubleshooting	249
Warning messages and error codes.....	251

Troubleshooting

Soft Starter Does Not Start, No Error Code Displayed

1. If no display: verify the soft starter supply.
2. Verify the presence of the RUN command.

Soft Starter Does Not Start, Error Code Displayed

Step	Action
1	Disconnect all power, including external control power that may be present.
2	Lock all power switches in the open position.
3	Verify the absence of voltage using a properly rated voltage sensing device.
4	Find and correct the cause of the detected error. Refer to the list of possible detected errors.
5	Restore power to the soft starter to confirm that the detected error has been cleared.

When an error is triggered the Warning/Error led is red on.

The soft starter behavior can be set for the following errors:

- **[Modbus Error Resp]** [SLL](#)
- **[AI1 Th Error Resp]** [TH1B](#)

For all other detected errors the soft starter stop in freewheel.

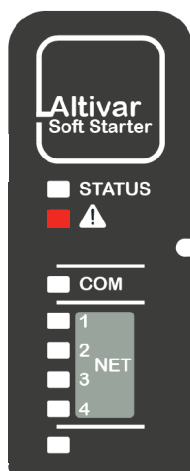

How To Clear the Error Codes?

The following table summarizes the possibilities to clear a detected error:

How to clear the error code after the cause has been removed	List of the cleared errors
<p>Power reset:</p> <ul style="list-style-type: none"> Power-Off and On the soft starter. 	All detected errors.
<p>Manual reset:</p> <p>Perform one of the following actions to reset the device:</p> <ul style="list-style-type: none"> Press STOP / RESET key, if [Control Mode] CHCF is set to [Standard Profile] STD and [Command Switching] CCS to the display terminal. Apply a rising edge to the digital input assigned to [Fault Reset] LIRSF, if [Command Switching] CCS is set to control terminals. Activate the digital input RUN if [Fault Reset] LIRSF is not assigned. Activate the digital input RUN a second time to start the motor. Consider the value set to [Command Switching] CCS to apply a Run command. 	<p>DWF, EPF1, EPF2, LRF, OHF, OLC, OLF, SLF1, SMPF, TLSE, ULF</p> <p>And all the error codes belonging to the following categories, after the automatic restart time is elapsed:</p> <ul style="list-style-type: none"> Automatic restart Automatic restart limited duration Automatic restart limited retry
<p>Automatic restart:</p> <p>Restart the product with unlimited automatic reset attempts at intervals of 60 seconds after the error has been triggered if:</p> <ol style="list-style-type: none"> The cause has been removed [Auto Fault Reset] ATR is set to [Yes] YES <p>In 2 or 3 wires command the motor will start if the Run command is applied or maintained.</p> <p>If [Control Mode] CHCF is set to [Standard Profile] STD and [Command Switching] CCS to the display terminal, you can press STOP / RESET key on the display terminal.</p> <p>If [Auto Fault Reset] ATR is set to [No] NO this detected error can be cleared with:</p> <ul style="list-style-type: none"> Power reset Manual reset 	USF, CLF
<p>Automatic restart limited duration:</p> <ul style="list-style-type: none"> Same as automatic restart at intervals of 60 seconds. Maximum time for successful automatic reset set with [Fault Reset Time] TAR. When [Fault Reset Time] TAR is elapsed, the detected error requires a manual reset or a power reset. 	CNF, COF, FDR2, SLF2, SLF3, T1CF, TH1F
<p>Automatic restart limited retry:</p> <ul style="list-style-type: none"> Same as automatic restart with 6 automatic reset attempts maximum at intervals of 60 seconds. When the maximum number of retry is elapsed, the detected error requires a manual reset or a power reset. 	FRF, LCF, PHF1, PHF2, PHF3, PHF4
<p>Transient:</p> <ul style="list-style-type: none"> As soon as its cause has been removed. 	CFF, CFF2, CFI, CFI2, CSF, FWER, FWMC, FWPF, HCF, INFZ, SPFC, SPTF

Warning messages and error codes

What's in This Chapter

Warning Messages.....	252
[Bypass Error] BYF	253
[Incorrect Config] CFE	253
[Config Change] CFE2	253
[Invalid Config] CFI	254
[Conf Transfer Error] CFI2	254
[Control Supply Error] CLF	254
[Fdbus Com Interrupt] CNF	255
[Cust Supply Error] CPSF	255
[CANopen Com Interrupt] COF	255
[CANopen Init Error] COLF	256
[Channel Switch Error] CSF	256
[In Delta Wiring Error] DWF	256
[Ctrl Memory Error] EEF1	257
[Pwr Memory Error] EEF2	257
[External Error] EPF1	257
[Fieldbus Error] EPF2	258
[FDR 2 Error] FDR2	258
[Mains Freq Error] FRF	258
[FW Update Error] FWER	259
[No Power Comm Error] FWMC	259
[Fware Pairing Err] FWPF	259
[Internal Link Error] ILF	260
[Internal Error 1] INF1	260
[Internal Error 3] INF3	260
[Internal Error 4] INF4	261
[Internal Error 6] INF6	261
[Internal Error 8] INF8	261
[Internal Error 14] INFE	262
[Internal Error 15] INFF	262
[Internal Error 21] INFL	262
[Internal Error 25] INFP	262
[Internal Error 35] INFZ	263
[Input Contactor] LCF	263
[Lock Rotor Error] LRF	263
[Overcurrent] OCF	264
[Device Overheat] OHF	264
[Process Overload] OLC	264
[Motor Overload] OLF	265
[Mains Sync Error] PHF1	265
[Mains Direction Error] PHF2	265
[Phase Loss] PHF3	266
[Mains Loss] PHF4	266
[Phase Inversion] PIF	266
[Ground Short Circuit] SCF3	267
[Mdb Com Interrupt] SLF1	267
[PC Com Interrupt] SLF2	267
[HMI Com Interruption] SLF3	267
[Simu Mains Detected] SMPF	268
[Security Files Corrupt] SPFC	268
[Sec Policy Update Err] SPTF	268
[AI1 Th Sensor Error] T1CF	268
[AI1 Th Level Error] TH1F	269
[Too Long Start Err] TLSF	269
[Proc Underload] ULF	269
[Supply Mains UnderV] USF	270

Warning Messages

List of Available Warning Messages

Any warning that is triggered but is not assigned to a warning group in Access path: **[Complete settings] → [Warn groups config]** will not be visible on the display terminal, will not be signaled by the LEDs of the soft starter and will not be logged.



By default the following warnings are assigned to a warning group:

- **[No Battery Warn]** [RBNA](#)
- **[Low Battery Warn]** [RBLA](#)
- **[Invalid RTC Warn]** [RTCA](#)

Setting	Code	Description
[Device Th Warn]	THA	Device thermal state warning , see 7.2 [Thermal Monitoring] TPM , page 212.
[Ext. Error Warn]	EFA	External error warning , see 3.9 [Error/Warn handling] CSWM , page 178.
[UnderV Warn]	USA	Undervoltage warning , see Set The Mains Voltage, page 111.
[Proc Undld Warn]	ULA	Process underload warning , see 2.2 [Process underload] ULD , page 150.
[Proc Overload Warn]	OLA	Process overload warning , see 2.4 [Process overload] OLD , page 152.
[Dev Th reached]	TAD	Device thermal threshold reached , see 7.2 [Thermal Monitoring] TPM , page 212.
[AI1 Th Warning]	TP1A	AI1 thermal sensor warning , see 2.11 [Thermal monitoring] TPP , page 153.
[Motor Overload Warn]	OLMA	Motor overload warning , see [Simply Start] SYS , page 108.
[Low Battery Warn]	RBLA	Soft starter Low Battery warning
[No Battery Warn]	RBNA	Soft starter Battery not detected warning
[Invalid RTC Warn]	RTCA	Invalid RTC warning
[Bypass Warn]	BPA	Bypass warning
[Modbus Com Warn]	SLLA	Modbus comm interruption warning , see 6.1 [Modbus Fieldbus] MD1 , page 196.
[Fieldbus Com Warn]	CLLA	Fieldbus comm interruption warning , see 6 [Communication] COM , page 195.
[CANopen Com Warn]	COLA	CANOpen comm interruption warning , see 6 [Communication] COM , page 195.
[Inhibited Errors Warn]	INH	Inhibited errors warning , see Smoke Extraction, page 136.
[Temp Sens AI1 Warn]	TS1A	Temperature sensor AI1 warning , see 2.11 [Thermal monitoring] TPP , page 153.



[Bypass Error] BYF

Bypass error

 Probable Cause	<ul style="list-style-type: none"> • External bypass not opened during stop sequence • External bypass not functional • Bad wiring between R2 and the external bypass • Relay R2 assigned to external bypass command not working
 Remedy	<ul style="list-style-type: none"> • Verify the external bypass • Verify the wiring between R2 and the external bypass • Verify the relay R2, if R2 is not functional contact your local Schneider Electric representative
 Clearing the Error Code	<p>This detected error requires a power reset of the device after its cause has been removed.</p>



[Incorrect Config] CFF

Incorrect configuration

 Probable Cause	<ul style="list-style-type: none"> • Option module has been changed for another fieldbus or removed. • Control block replaced by a control block configured on a soft starter with a different rating. • The current configuration is inconsistent.
 Remedy	<ul style="list-style-type: none"> • Verify that the option module or the product are not damaged. • In the event of the control block being changed deliberately, see the remarks below. • Press the OK key to validate the message displayed on the display terminal. This action will set a return to factory settings. • Or retrieve the backup configuration if it is valid.
 Clearing the Error Code	<p>This detected error is cleared as soon as its cause has been removed.</p>



[Config Change] CFF2

Configuration change

 Probable Cause	<p>A fieldbus module has been plugged while [Control Mode] CHCF was set to [SE8 Profile] SE8 and the device was not in initial setup mode.</p>
 Remedy	<ul style="list-style-type: none"> • Press the OK key to validate the message displayed on the display terminal. This action will change [Control Mode] CHCF from [SE8 Profile] SE8 to [Standard Profile] STD • Or turn Off the soft starter, remove the fieldbus module and turn On the soft starter.
 Clearing the Error Code	<p>This detected error is cleared as soon as its cause has been removed.</p>



[Invalid Config] CFI

Invalid configuration

 Probable Cause	Inconsistent, invalid, unauthorized or out-of-bound value written to a parameter via a fieldbus or communication link. The written value is rejected, the previous one is kept and this error is triggered.
 Remedy	This error is automatically cleared after: <ul style="list-style-type: none"> • Writing a correct value on any parameters via communication or fieldbus link. • Writing a correct value on any parameters via any HMI (display terminal, SoMove...). • Reset to factory settings, new configuration transfer or configuration restoration.
 Clearing the Error Code	This detected error is cleared as soon as its cause has been removed.



[Conf Transfer Error] CFI2

Configuration transfer error

 Probable Cause	<ul style="list-style-type: none"> • The configuration transfer to the soft starter was not successful or interrupted. • The configuration loaded is not compatible with the soft starter.
 Remedy	<ul style="list-style-type: none"> • Verify the configuration loaded previously • Load a compatible configuration • Use a PC software commissioning tool to transfer a compatible configuration • Perform a factory setting <p>NOTE: When this error is triggered, the current security configuration is kept valid and applied.</p>
 Clearing the Error Code	This detected error is cleared as soon as its cause has been removed.



[Control Supply Error] CLF

Control supply error

 Probable Cause	<ul style="list-style-type: none"> • Loss of control power supply on CL1 and CL2 terminals. • Control power supply out of bounds.
 Remedy	<ul style="list-style-type: none"> • Verify the control supply is wired on the terminals CL1 and CL2. • In the case of an external +24V power supply, check the presence of the control supply voltage of terminals CL1 and CL2. It must be 110...230 Vac +10% – 15%. • In the case of an external +24V power supply, to prevent this error from triggering, disable the monitoring of CL1 / CL2 power supply loss by setting [Control Supply Loss] in the menu [Complete settings] → [Error/Warn handling] to [Warning]. This will instead triggers the warning [Ctrl Supply Loss] CLA without blocking the device.
 Clearing the Error Code	This detected error can be cleared with the [Auto Fault Reset] or manually with the [Fault Reset Assign] parameter after its cause has been removed.



[Fdbus Com Interrupt] CNF

Fieldbus communication interruption

 Probable Cause	<p>Communication interruption on fieldbus module.</p> <p>This error is triggered when the communication between the fieldbus module and the master (PLC) is interrupted.</p>
 Remedy	<ul style="list-style-type: none"> • Verify the environment (electromagnetic compatibility). • Verify the wiring. • Verify the timeout. • Replace the option module. • Contact your local Schneider Electric representative.
 Clearing the Error Code	<p>This detected error can be cleared with the [Auto Fault Reset] or manually with the [Fault Reset Assign] parameter after its cause has been removed.</p>



[Cust Supply Error] CPSF

Customer supply error

 Probable Cause	<p>The error is triggered if the external 24VDC supply voltage is higher than the maximum DC voltage 30V, or lower than the minimum DC voltage 19V</p> <ul style="list-style-type: none"> • The external supply is not operating correctly. • The +24V terminal consumption has been greater than 200mA
 Remedy	<ul style="list-style-type: none"> • Verify the external 24VDC supply applied on the +24 terminal. • Verify the current on the +24 terminal. • Verify there is no short circuit between 0 and +24 terminal. • Check the value of the [Cust Supply Diag] parameter: <ul style="list-style-type: none"> ◦ Value = 0x00 : No power supply error detected since startup ◦ Value = 0x11 : Overcurrent detected on customer 24V supply ◦ Value = 0x21 : Overvoltage detected on customer 24V supply ◦ Value = 0x31 : Too many short undervoltages detected on customer 24V supply • Contact your local Schneider Electric representative.
 Clearing the Error Code	<p>This detected error requires a power reset of the device after its cause has been removed.</p>



[CANopen Com Interrupt] COF

CANopen communication interruption

 Probable Cause	<p>Communication interruption on the CANopen® fieldbus.</p>
 Remedy	<ul style="list-style-type: none"> • Verify the communication fieldbus. • Verify the timeout • Refer to the CANopen® user manual
 Clearing the Error Code	<p>This detected error can be cleared with the [Auto Fault Reset] or manually with the [Fault Reset Assign] parameter after its cause has been removed.</p>



[CANopen Init Error] COLF

CANopen initialization error

 Probable Cause	CANopen could not initialize because the device baudrate is incompatible with the controller baudrate.
 Remedy	<ul style="list-style-type: none"> • Verify the device baudrate • Verify the baudrate of other devices on the network • If the error persists, disconnect the device from the network
 Clearing the Error Code	This detected error requires a power reset of the device after its cause has been removed.



[Channel Switch Error] CSF

Channel switching detected error

 Probable Cause	Switch to an invalid channel.
 Remedy	Verify the settings of the parameters in the menu [Complete settings] CST → [Command channel] CCP .
 Clearing the Error Code	This detected error is cleared as soon as its cause has been removed.



[In Delta Wiring Error] DWF

Inside Delta wiring error

 Probable Cause	Incorrect inside-delta wiring detected by [In Delta Diag Status] DLTS .
 Remedy	Refer to Diagnostic Of The Delta Connection, page 120 to perform the actions described by [In Delta Diag Status] DLTS .
 Clearing the Error Code	This detected error can be cleared manually with the [Fault Reset Assign] parameter after its cause has been removed.



[Ctrl Memory Error] EEF1

Control memory error

	Probable Cause	An error of the internal memory of the control block has been detected.
	Remedy	<ul style="list-style-type: none"> • Verify the environment (electromagnetic compatibility). • Do a power cycle. • Return to factory settings. • Contact your local Schneider Electric representative.
	Clearing the Error Code	This detected error requires a power reset of the device after its cause has been removed.



[Pwr Memory Error] EEF2

Power memory error

	Probable Cause	An error of the internal memory of the power board has been detected.
	Remedy	<ul style="list-style-type: none"> • Verify the environment (electromagnetic compatibility). • Do a power cycle. • Return to factory settings. • Contact your local Schneider Electric representative.
	Clearing the Error Code	This detected error requires a power reset of the device after its cause has been removed.



[External Error] EPF1

External detected error

	Probable Cause	<ul style="list-style-type: none"> • Error raised based on [Ext Error assign] configuration via [DI•] or [CD••].
	Remedy	Remove the cause of the external error.
	Clearing the Error Code	This detected error can be cleared manually with the [Fault Reset Assign] parameter after its cause has been removed.



[Fieldbus Error] EPF2

External error detected by Fieldbus

 Probable Cause	Communication interruption with fieldbus module.
 Remedy	<ul style="list-style-type: none"> • Verify the communication bus is correctly wired. • Verify the fieldbus module is correctly plugged into the soft starter. • Refer to the appropriate fieldbus manual.
 Clearing the Error Code	This detected error can be cleared manually with the [Fault Reset Assign] parameter after its cause has been removed.



[FDR 2 Error] FDR2

FDR Eth module error

 Probable Cause	<ul style="list-style-type: none"> • Ethernet fieldbus module FDR error. • Communication interruption between the soft starter and the PLC. • Configuration file incompatible, empty or corrupted. • Soft starter rating not consistent with the configuration file.
 Remedy	<ul style="list-style-type: none"> • Verify the soft starter and PLC connection. • Verify the communication workload. • Restart the transfer of configuration file from soft starter to PLC.
 Clearing the Error Code	This detected error can be cleared with the [Auto Fault Reset] or manually with the [Fault Reset Assign] parameter after its cause has been removed.





[Mains Freq Error] FRE

Mains frequency out of tolerance

 Probable Cause	<ul style="list-style-type: none"> • Mains supply frequency out of the tolerance 50 / 60 Hz • Detected mains frequency at motor start different from the expected value set in [Mains Frequency] FRC
 Remedy	<ul style="list-style-type: none"> • Verify the mains supply frequency respect the tolerance 50...60 Hz, +/-5% (47,5...63 Hz) • Verify the expected mains supply frequency set in [Complete settings] CST → [Motor parameters] MPA → [Mains Frequency] FRC correspond to the frequency of your mains supply.
 Clearing the Error Code	This detected error can be cleared with the [Auto Fault Reset] or manually with the [Fault Reset Assign] parameter after its cause has been removed.



[FW Update Error] FWER

Firmware Update error

 Probable Cause	Firmware update function has detected an error.
 Remedy	 <ol style="list-style-type: none"> In the menu [Device Management] DMT → [Firmware update] FWUP scroll to the parameter [Available Packages] APK and clear all the package . Upload a new firmware Proceed with a new firmware update. For more information, refer to 9.8 [Firmware update] FWUP , page 234.
 Clearing the Error Code	This detected error is cleared as soon as its cause has been removed.



[No Power Comm Error] FWMC

No power communication error

 Probable Cause	<ul style="list-style-type: none"> No communication with power part while CL1/CL2 supply is present. Power firmware is invalid or a hardware failure has occurred
 Remedy	<ul style="list-style-type: none"> Try to restore power firmware If the LEDs Warning/Error and COM are red and yellow, perform a power reset. If the problem persists, contact your local Schneider Electric representative Refer to 9.8 [Firmware update] FWUP, page 234.
 Clearing the Error Code	This detected error is cleared as soon as its cause has been removed.



[Fware Pairing Err] FWPF

Firmware pairing error

 Probable Cause	Current firmware configuration is inconsistent.
 Remedy	<ul style="list-style-type: none"> Update the complete firmware of the device. Refer to 9.8 [Firmware update] FWUP, page 234. If the problem persists, contact your local Schneider Electric representative.
 Clearing the Error Code	This detected error is cleared as soon as its cause has been removed.



[Internal Link Error] ILF

Internal communication interruption with option module

 Probable Cause	Communication interruption between option module and the soft starter.
 Remedy	<ul style="list-style-type: none"> • Verify the environment (electromagnetic compatibility). • Verify that the fieldbus module is well inserted in the soft starter. • Replace the fieldbus module with an identical fieldbus module. • Contact your local Schneider Electric representative. <p>NOTE: it is possible to check the status of ILF through the communication with his register (ADL: 7134).</p>
 Clearing the Error Code	This detected error requires a power reset of the device after its cause has been removed.



[Internal Error 1] INF1

Internal error 1 (Rating)

 Probable Cause	The power board rating is not valid.
 Remedy	Contact your local Schneider Electric representative.
 Clearing the Error Code	This detected error requires a power reset of the device after its cause has been removed.



[Internal Error 3] INF3

Internal error 3 (Intern Comm)

 Probable Cause	Internal communication detected error
 Remedy	Contact your local Schneider Electric representative.
 Clearing the Error Code	This detected error requires a power reset of the device after its cause has been removed.



[Internal Error 4] INF4

Internal error 4 (Manufacturing)

 Probable Cause	Internal data inconsistent.
 Remedy	Contact your local Schneider Electric representative
 Clearing the Error Code	This detected error requires a power reset of the device after its cause has been removed.



[Internal Error 6] INF6

Internal error 6 (Option)

 Probable Cause	<p>The compatibility of the option module is monitored internally.</p> <p>If an unknown module is installed, the INF6 error is triggered.</p> <ul style="list-style-type: none"> The option module is not recognized by the device nor compatible with the device.
 Remedy	<ul style="list-style-type: none"> To identify the error code, convert from decimal (ex: 4111) to hexadecimal (ex: 100F) the code displayed on the display terminal in the parameter [Error Info (INF6)] INF6, read the last two characters on the right (ex: 0F) and refer to the following list: <ul style="list-style-type: none"> Value = 0x●●00: No error detected. Value = 0x●●01: No response of the fieldbus module. Unplug and plug back the fieldbus module. Value = 0x●●09, 0x●●0B, 0x●●11: Incompatible fieldbus module. For the list of compatible fieldbus modules, refer to the catalog and to the fieldbus manuals. Value = 0x●●0F: Option module software version not compatible. Update the fieldbus module firmware, refer to 9.8 [Firmware update] FWUP, page 234. Verify the catalog number and compatibility of the option module. If the displayed code is not listed above, contact your local Schneider Electric representative.
 Clearing the Error Code	This detected error requires a power reset of the device after its cause has been removed.



[Internal Error 8] INF8

Internal error 8 (Switching Supply)

 Probable Cause	The internal power switching supply is not correct.
 Remedy	<ul style="list-style-type: none"> Check the supplies of the installation. Contact your local Schneider Electric representative.
 Clearing the Error Code	This detected error requires a power reset of the device after its cause has been removed.



[Internal Error 14] INFE

Internal error 14 (CPU)

 Probable Cause	Internal microprocessor detected error.
 Remedy	<ul style="list-style-type: none"> • Verify that the error code can be cleared with a power reset. • Contact your local Schneider Electric representative.
 Clearing the Error Code	This detected error requires a power reset of the device after its cause has been removed.



[Internal Error 15] INF5

Internal error 15 (Flash)

 Probable Cause	Serial memory flash format error.
 Remedy	Contact your local Schneider Electric representative.
 Clearing the Error Code	This detected error requires a power reset of the device after its cause has been removed.



[Internal Error 21] INFL

Internal error 21 (RTC)

 Probable Cause	Internal Real Time Clock error. It could be a clock oscillator start error.
 Remedy	Contact your local Schneider Electric representative.
 Clearing the Error Code	This detected error requires a power reset of the device after its cause has been removed.



[Internal Error 25] INF5

Internal error 25 (Incompatibility CB & SW)

 Probable Cause	Incompatibility between control board hardware version and firmware version.
 Remedy	<ul style="list-style-type: none"> • Update the firmware package. • Contact your local Schneider Electric representative
 Clearing the Error Code	This detected error requires a power reset of the device after its cause has been removed.



[Internal Error 35] INFZ

Internal error 35 (Invalid firmware version)

	Probable Cause	Invalid firmware version.
	Remedy	<ul style="list-style-type: none"> • Update product firmware with an official version from EcoStruxure Automation Device Maintenance or SoMove. • Contact your local Schneider Electric representative.
	Clearing the Error Code	This detected error is cleared as soon as its cause has been removed.



[Input Contactor] LCF

input contactor

	Probable Cause	<p>The soft starter power stage is not supplied even though:</p> <ul style="list-style-type: none"> • [Mains V. time out] LCT time-out has elapsed. • The relay assigned to the contactor should be activated. • The line contactor should be closed.
	Remedy	<ul style="list-style-type: none"> • Verify the settings of the parameters in the menu [Complete settings] CST → [Mains contactor cmd] LLC. • Verify the line contactor is in working order and its wiring. • Verify the line contactor coil is wired to the soft starter output. • Verify the presence mains supply on the line contactor and on the soft starter power stage inputs.
	Clearing the Error Code	This detected error can be cleared with the [Auto Fault Reset] or manually with the [Fault Reset Assign] parameter after its cause has been removed.



[Lock Rotor Error] LRF

Lock rotor error

	Probable Cause	<p>This error is triggered only when the soft starter is bypassed and the motor current is over 5 times the nominal motor current for more than 200 milliseconds.</p> <p>The overcurrent can be due to a blocked rotor.</p>
	Remedy	<ul style="list-style-type: none"> • Check the mechanism (wear, mechanical gap, lubrication, blockages, ...) • Verify the process is not blocking the rotor of the motor.
	Clearing the Error Code	This detected error can be cleared manually with the [Fault Reset Assign] parameter after its cause has been removed.



[Overcurrent] OCF

Overcurrent

 Probable Cause	<ul style="list-style-type: none"> • Short circuit (motor side). • Parameter [Boost] <code>BST</code> is not correct (if used). • Load too high (Mechanical locking). • Internal current sensor malfunction • Soft starter thyristor malfunction <p>If the soft starter was in [Ready] <code>RDY</code> state, it can be a short circuit between soft starter thyristor and output to motor.</p> <p>In this case the current monitored on the display terminal doesn't correspond to the real current injected in the motor.</p>
 Remedy	<ul style="list-style-type: none"> • Verify if a short circuit (motor side) appears. • Check [Boost] <code>BST</code> configuration (if used). • Verify the motor. • Verify the size of the motor / load. • Verify the state of the mechanism. • Contact your local Schneider Electric representative.
 Clearing the Error Code	<p>This detected error requires a power reset of the device after its cause has been removed.</p>



[Device Overheat] OHF

Device overheating

 Probable Cause	<ul style="list-style-type: none"> • Device temperature above tolerance, [Device Thermal State] <code>THS</code> > 118% • Thyristor normal temperature exceeded • Thermal sensor internal to the soft starter disconnected or in short-circuit
 Remedy	<ul style="list-style-type: none"> • Verify the ambient temperature, the device ventilation and the motor load. Wait for the device to cool down before restarting. • An excessive load can overheat the soft starter. • An excessive amount of starting can overheat the soft starter. • If the error is triggered during the ramp-up, set a more gentle start in the menu [Simply start] <code>SIM</code>. • If it is internal thermal sensor malfunction contact your Customer Care Center on: www.schneider-electric.com/CCC.
 Clearing the Error Code	<p>This detected error can be cleared manually with the [Fault Reset Assign] parameter after its cause has been removed.</p>



[Process Overload] OLC

Process overload

 Probable Cause	<ul style="list-style-type: none"> • Excessive load. • Triggered by excessive motor current.
 Remedy	<ul style="list-style-type: none"> • Verify and remove the cause of the overload on your process • Verify the parameters of the [Overload Threshold] <code>LOC</code> function.
 Clearing the Error Code	<p>This detected error can be cleared with the [Auto Fault Reset] or manually with the [Fault Reset Assign] parameter after its cause has been removed.</p>



[Motor Overload] OLF

Motor overload

 Probable Cause	This error is triggered when an excessive motor current has been detected.
 Remedy	<ul style="list-style-type: none"> • Verify the motor load. Wait for the device to cool down before restarting. • An excessive load can overheat the motor. • An excessive amount of starting can overheat the motor. • Verify [Motor Class] THP parameter is well configured.
 Clearing the Error Code	This detected error can be cleared manually with the [Fault Reset Assign] parameter after its cause has been removed.



[Mains Sync Error] PHF1

Mains synchronization error

 Probable Cause	<ul style="list-style-type: none"> • Unbalanced phases during acceleration and deceleration • Loss of a phase when [Phase Loss Monit] PHF is set to [No] NO (inhibition of phase loss by low current).
 Remedy	<ul style="list-style-type: none"> • Verify the motor supply connection and any isolating devices located between the soft starter and the motor (contactors, circuit-breakers,...) • Verify the supply frequency stability • Adjust [Gamma Sync Error] TSC to set the threshold before this error triggers. The higher is the set value, the less sensitive is the synchronisation monitoring. • Contact your local Schneider Electric representative.
 Clearing the Error Code	This detected error can be cleared with the [Auto Fault Reset] or manually with the [Fault Reset Assign] parameter after its cause has been removed.



[Mains Direction Error] PHF2

Mains direction error

 Probable Cause	<p>At RUN order:</p> <ul style="list-style-type: none"> • The main frequency (FAC) is not in the tolerances. • The detected phase direction (PHE) is not recognized. • One phase is missing.
 Remedy	<ul style="list-style-type: none"> • Check mains supply wiring. • Verify the mains supply connection and any devices located between the mains and the soft starter (contactor, fuses, circuit-breaker,...)
 Clearing the Error Code	This detected error can be cleared with the [Auto Fault Reset] or manually with the [Fault Reset Assign] parameter after its cause has been removed.



[Phase Loss] PHF3

Phase loss error

 Probable Cause	<p>The current in one phase is lower than the threshold set in [Phase Loss Thd] <small>PHL</small>.</p> <p>This may be due to:</p> <ul style="list-style-type: none"> • Loss of one or several phases on mains or motor side • Soft starter incorrectly supplied or tripped fuses. • Defective motor • Defective wiring on the motor or the supply mains
 Remedy	<ul style="list-style-type: none"> • Verify the threshold set in [Phase Loss Thd] <small>PHL</small> is compatible with the motor. • Verify the motor supply wiring and any devices located between the mains and the soft starter (contactor, fuses, circuit-breaker,...) • Verify the motor
 Clearing the Error Code	<p>This detected error can be cleared with the [Auto Fault Reset] or manually with the [Fault Reset Assign] parameter after its cause has been removed.</p>



[Mains Loss] PHF4

Mains loss error

 Probable Cause	<ul style="list-style-type: none"> • Loss of the 3 mains phases • Soft starter incorrectly supplied or several tripped fuses. • Defective wiring on the mains side
 Remedy	<ul style="list-style-type: none"> • Verify the mains supply connection and any devices located between the mains and the soft starter (contactor, fuses, circuit-breaker,...)
 Clearing the Error Code	<p>This detected error can be cleared with the [Auto Fault Reset] or manually with the [Fault Reset Assign] parameter after its cause has been removed.</p>



[Phase Inversion] PIF

Phase inversion

 Probable Cause	<ul style="list-style-type: none"> • Detected phase direction at motor start different from the expected direction set in [Phase Inversion Mon] <small>PHR</small> in the menu [Monitoring] <small>PROT</small>.
 Remedy	<ul style="list-style-type: none"> • Verify the direction set in [Phase Inversion Mon] <small>PHR</small> in the menu [Monitoring] <small>PROT</small>. • Verify the direction of the mains wiring upstream the soft starter • Invert two mains phases upstream the soft starter.
 Clearing the Error Code	<p>This detected error requires a power reset of the device after its cause has been removed.</p>



[Ground Short Circuit] SCF3

Ground short circuit

 Probable Cause	Significant ground leakage current at the device output if several motors are connected in parallel.
 Remedy	<ul style="list-style-type: none"> • Verify the cables connecting the soft starter to the motor and the motor insulation. • Connect chokes in series with the motor.
 Clearing the Error Code	This detected error requires a power reset of the device after its cause has been removed.



[Mdb Com Interrupt] SLF1

Modbus communication interruption

 Probable Cause	Communication interruption on the Modbus port.
 Remedy	<ul style="list-style-type: none"> • Verify the communication bus. • Verify the timeout. • Refer to the Modbus communication manual.
 Clearing the Error Code	This detected error can be cleared manually with the [Fault Reset Assign] parameter after its cause has been removed.



[PC Com Interrupt] SLF2

PC communication interruption

 Probable Cause	Communication interruption with the commissioning software.
 Remedy	<ul style="list-style-type: none"> • Verify the commissioning software connecting cable. • Verify the timeout.
 Clearing the Error Code	This detected error can be cleared with the [Auto Fault Reset] or manually with the [Fault Reset Assign] parameter after its cause has been removed.



[HMI Com Interruption] SLF3

HMI communication interruption

 Probable Cause	<p>Communication interruption with the Graphic display terminal.</p> <p>This error is triggered when the command value is given using the Graphic Display Terminal and if the communication is interrupted during more than 2 seconds.</p>
 Remedy	<ul style="list-style-type: none"> • Verify the display terminal connection. • Verify the timeout.
 Clearing the Error Code	This detected error can be cleared with the [Auto Fault Reset] or manually with the [Fault Reset Assign] parameter after its cause has been removed.



[Simu Mains Detected] SMPF

Mains detected in simulation mode

 Probable Cause	Mains supply detected by the soft starter in simulation mode.
 Remedy	Verify that the mains supply is not wired to the soft starter and that the simulation mode is activated at the same time.
 Clearing the Error Code	This detected error can be cleared manually with the [Fault Reset Assign] parameter after its cause has been removed.



[Security Files Corrupt] SPFC

Security files corrupt

 Probable Cause	Security file corrupted or missing.
 Remedy	<ul style="list-style-type: none"> Connect a display terminal to your device, if not already connected. The error code is displayed. Press OK and select a cybersecurity profile. Refer to Go to product by setting cybersecurity policy (advanced, minimum), page 101
 Clearing the Error Code	This detected error is cleared as soon as its cause has been removed.



[Sec Policy Update Err] SPTF

Security policy update error

 Probable Cause	Security policy transfer error, invalid security configuration.
 Remedy	<ul style="list-style-type: none"> Check the security policy to transfer and transfer it again. Check the connection.
 Clearing the Error Code	This detected error is cleared as soon as its cause has been removed.

[AI1 Th Sensor Error] T1CF

Thermal sensor error on AI1

 Probable Cause	The thermal monitoring function has detected an error of the thermal sensor connected to the analog input AI1: <ul style="list-style-type: none"> Open circuit or short circuit
 Remedy	<ul style="list-style-type: none"> Verify the sensor and its wiring. Replace the sensor.
 Clearing the Error Code	This detected error can be cleared with the [Auto Fault Reset] or manually with the [Fault Reset Assign] parameter after its cause has been removed.

[AI1 Th Level Error] TH1F

AI1 thermal level error



Probable Cause

The thermal sensor monitoring function has detected a high temperature on the thermal sensor connected to the analog input AI1.



Remedy

- Search for a possible cause of overheating.
- Verify the settings of the monitoring function.



Clearing the Error Code

This detected error can be cleared with the **[Auto Fault Reset]** or manually with the **[Fault Reset Assign]** parameter after its cause has been removed.

[Too Long Start Err] TLSF

Too long start error



Probable Cause

[Too Long Start] TLS is elapsed before meeting end of start conditions.



Remedy

- Search for a mechanical jam blocking the motor.
- Search for a possible cause of motor overload.
- Verify the start profile in the **[Simply Start] SYS** menu.
- Verify the value set to **[Too Long Start Err] TLSF**.



Clearing the Error Code

This detected error can be cleared manually with the **[Fault Reset Assign]** parameter after its cause has been removed.

[Proc Underload] ULF

Process underload



Probable Cause

Load too low.



Remedy

- Verify and remove the cause of the underload.
- Verify the parameters of the **[Process underload] ULD** function.





Clearing the Error Code

This detected error can be cleared with the **[Auto Fault Reset]** or manually with the **[Fault Reset Assign]** parameter after its cause has been removed.

[Supply Mains UnderV] U5F

Supply mains undervoltage

 Probable Cause	<ul style="list-style-type: none">• Incorrect supply mains voltage.• Important voltage dip• A run order has been given while no mains was present (NLP).
 Remedy	<ul style="list-style-type: none">• Verify the mains supply.• Verify the value set to [Mains Voltage] ULN.
 Clearing the Error Code	This detected error can be cleared with the [Auto Fault Reset] or manually with the [Fault Reset Assign] parameter after its cause has been removed.

Maintenance

What's in This Part

Soft Starter, Display Terminals and Fieldbus Modules Update	272
Scheduled Servicing	274
Real Time Clock (RTC)	278
Decommissioning	279
Additional Support	280

Soft Starter, Display Terminals and Fieldbus Modules Update

Soft Starter Firmware Update



The ATS480 firmware can be updated via:

- **EcoStruxure Automation Device Maintenance**. You can download it and its user manual here: **EADM**.
- SoMove, refer to Related Documents.

Use one of the following serial communication cables:

- TCSMCNAM3M002P
- VW3A8127

Plain Text Display Terminal Languages Update

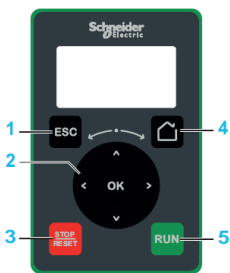

The Plain Text Display Terminal (VW3A1113) language files can be updated.

The transfer of the languages files is done with the transfer of the soft starter firmware package.

The application of the label package must be done manually when the display terminal is plugged to the soft starter ATS480 and the soft starter is powered (the application of the soft starter package and the application of the languages files are done separately).

Use one of the following serial communication cables:

- TCSMCNAM3M002P
- VW3A8127

Graphic Display Terminal Languages Update

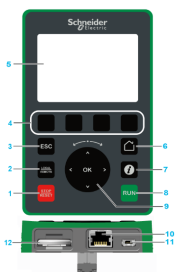

The Graphic Display Terminal (VW3A1111) language files can be updated.

Download the latest version of language files here: [Languages_Drives_VW3A1111](#)

The following table describes the procedure to update the language files of the Graphic Display Terminal:

Action	Step
1	Download the latest version of language files here: Languages_Drives_VW3A1111
2	Save the downloaded file on your computer.
3	Unzip the file and follow the instructions of the ReadMe text file.

Ethernet IP / Modbus TCP Fieldbus Module Firmware Update



The Ethernet IP / Modbus TCP Fieldbus Module (VW3A3720) can be updated via:

- Ecostruxure **A**utomation **D**evice **M**aintenance. You can download it and its user manual here: **EADM**.
- SoMove, refer to Related Documents.

Use an RJ45 – RJ45 Ethernet communication cable from the computer to the Ethernet IP / Modbus TCP Fieldbus Module.

PROFIBUS Module Firmware Update



To update the VW3A3607 PROFIBUS module, contact our Customer Care Center on: www.se.com/CCC.

PROFINET Module Firmware Update



The PROFINET Fieldbus Module (VW3A3647) can be updated via:

- Ecostruxure **A**utomation **D**evice **M**aintenance. You can download it and its user manual here: **EADM**.
- SoMove, refer to Related Documents.

Use an RJ45 – RJ45 Ethernet communication cable from the computer to the PROFINET Fieldbus Module.

Scheduled Servicing

Servicing

DANGER

HAZARD OF ELECTRIC SHOCK, EXPLOSION OR ARC FLASH

Read and understand the instructions in **Product Related Information** chapter before performing any procedure in this chapter.

Failure to follow these instructions will result in death or serious injury.

The temperature of the products described in this manual may exceed 80 °C (176 °F) during operation.

WARNING

HOT SURFACES

- Ensure that any contact with hot surfaces is avoided.
- Do not allow flammable or heat-sensitive parts in the immediate vicinity of hot surfaces.
- Verify that the product has sufficiently cooled down before handling it.
- Verify that the heat dissipation is sufficient by performing a test run under maximum load conditions.

Failure to follow these instructions can result in death, serious injury, or equipment damage.

WARNING

INSUFFICIENT MAINTENANCE

Verify that the maintenance activities described below are performed at the specified intervals.

Failure to follow these instructions can result in death, serious injury, or equipment damage.

Adherence to the environmental conditions must be ensured during operation of the device. In addition, during maintenance, verify and, if appropriate, correct all factors that may have an impact on the environmental conditions.

To verify	Part concerned	Activity	Interval (1)
Overall condition	All parts such as housing, HMI, control block, connections, etc.	Perform a visual inspection	At least every year
Corrosion	Terminals, connectors, screws	Inspect and clean if required	
Dust	Terminals, fans, cabinet air inlets and air outlets, air filters of cabinet		
Cooling	Soft starter fans	Perform a visual inspection of operating fans	
		Replace the fans, see catalog and the instructions sheets on se.com	After 3 to 5 years, depending on the operating conditions.
Fastening	All screws for electrical and mechanical connections	Verify tightening torques	At least every year
Device clock	Display terminal	Verify the displayed time and correct if required (for more information, refer to Real Time Clock (RTC), page 278)	At least every year
CR2032 device battery	On top side of the soft starter control block	Perform a visual inspection of the battery level on the display terminal	At least every year
(1) Maximum maintenance intervals from the date of commissioning. Reduce the intervals between maintenance to adapt maintenance to the environmental conditions, the operating conditions of the soft starter, and to any other factor that may influence the operation and / or maintenance requirements of the soft starter.			

NOTE: The fan operation depends on the soft starter thermal state. The soft starter may be running but not the fan.

Fans may continue to run for a certain period of time even after power to the product has been disconnected.

▲ CAUTION
RUNNING FANS
Verify that fans have come to a complete standstill before handling them.
Failure to follow these instructions can result in injury or equipment damage.

Replace the battery

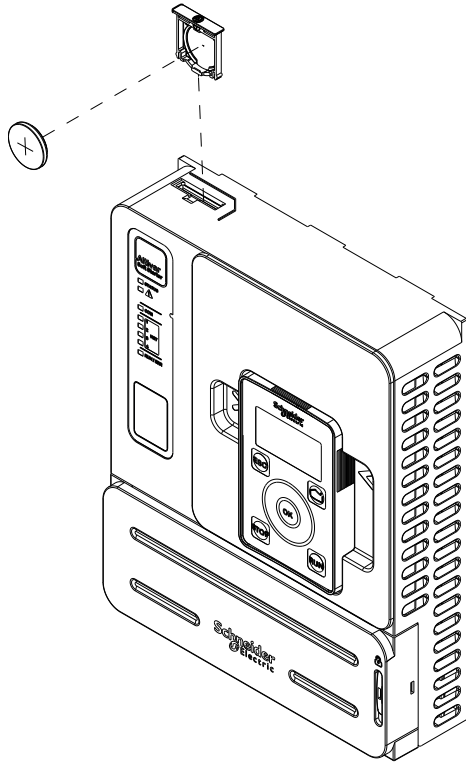
Step	Action
1	<p>Turn off your installation and remove the mains and CL1/CL2 supplies.</p> <p>Note:</p> <p>If the battery is empty :</p> <ul style="list-style-type: none"> • Removing the mains and CL1/CL2 supplies will result in date and time data loss. • The date and time need to be set at the next power up.
2	<p>Connect the +24 of the soft starter, page 54 to a +24V external source (if not already connected to an external source) and applied it to the product.</p> <p>Note:</p> <p>If the +24V is not applied or available:</p> <ul style="list-style-type: none"> • During the replacement of the battery, the date and time data will be lost. • The date and time need to be set at the next power up.
3	<p>Remove and replace the battery.</p> <p>Battery placement:</p> 
4	<p>After this operation, the +24V external source can be removed or turned off.</p>
5	<p>Connect to the mains and CL1/CL2 supplies and turn on your installation.</p>

Wear Parts

Order wear parts such as:

- Fan sub assembly

Corresponding soft starter	Reference
ATS480D32Y...D38Y	VZ3V481
ATS480D47Y	VZ3V4811
ATS480D62Y...C11Y	VZ3V482
ATS480C14Y...C17Y	VZ3V483
ATS480C21Y...C32Y	VZ3V484
ATS480C41Y...C66Y	VZ3V485
ATS480C79Y...M12Y (two kits necessary to replace all fans)	VZ3V485

- Control block (VX4G4801)
- Control blocks plastic covers (VY1G480M01)
- Control terminal strips (VY1G480C01)

Spare Parts

This product is repairable, please contact your Customer Care Center on:

www.se.com/CCC.

Real Time Clock (RTC)

Introduction

The soft starter has a real-time clock that provides the current date and time.

Clock Accuracy

The resolution of the real-time clock is 1 ms; The clock accuracy is affected by the operating temperature of the application:

Operating temperature	Maximum yearly drift at the first year of the product	Maximum yearly drift at the second year of the product	Maximum yearly drift at the third year of the product
25 °C (77 °F) stabilized	+/- 10.52 minutes	+/- 12.1 minutes	+/- 13.67 minutes
0...60 °C (32...140 °F)	+/- 36.8 minutes	+/- 38.38 minutes	+/- 39.95 minutes

Decommissioning

Uninstalling the Product

Observe the following procedure when uninstalling the device:

- If this device is going to be re-used in the future,
- Switch off all supply voltage. Verify that no voltage is present.

Refer to Product related information, page 9 for safety-related instructions.

- Remove all connection cables.
- Uninstall the product.

End of Life

The components of the product consist of different materials which can be recycled and which must be disposed of separately.

- Dispose of the packaging in compliance with all applicable regulations.
- Dispose of the product in compliance with all applicable regulations.

Refer to the **Environmental Data Program** for information and documents on environmental protection such as EoLI (End of Life Instruction).

You can download RoHS and REACH compliance declarations, Product Environmental Profiles (PEP) and End-of-Life instructions (EoLi).

Additional Support

Electronic product data sheet

Scan the QR code in front of the soft starter to get the product data sheet.

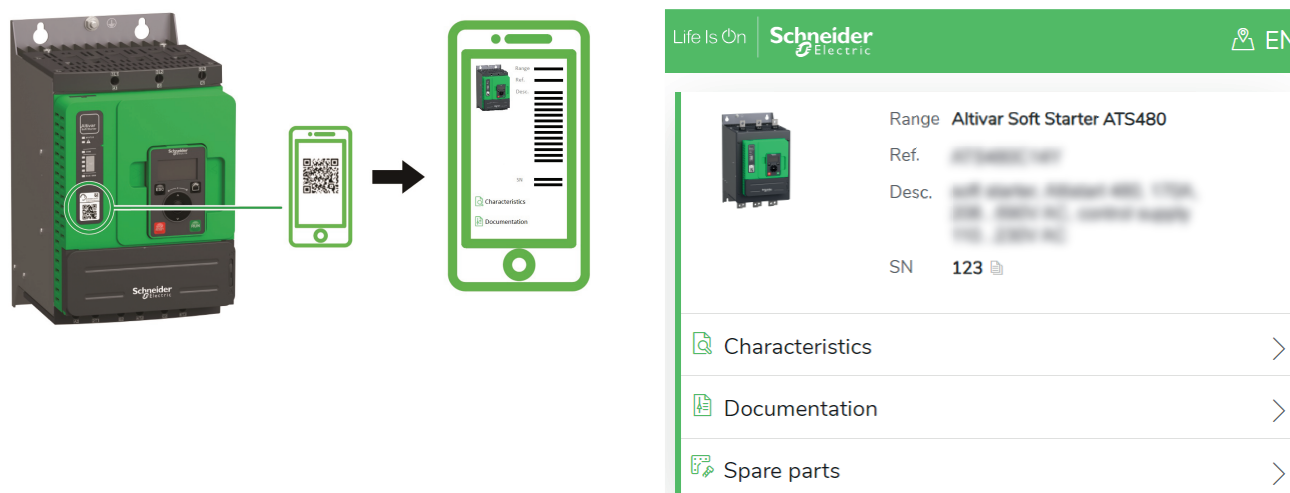

Scanning the QR Code gives you access to :

- Product ID Card : Product range, Reference, short description and a Serial Number (Use the serial number to retrieve the product's manufacturing date).
About the Serial Number, refer to Manufacturing Date, page 281.
- The product characteristics : Main characteristics, environment, packing units, sustainability...
- Documentation : Technical Guidance at Glance (Presentation, Dimensions, Mounting, Wiring, Commissioning...) and Product Documentation (User guide, Instructions sheets, Certificates, How To videos...)
- Spare parts for your product

Manufacturing Date

Use the serial number on the nameplate of the soft starter to retrieve its manufacturing date.

The four digits before the 2 characters of the serial number provide respectively the year and the week of manufacture.

In the example below HL2422110100130 the manufacturing date is year 2024, week 22.



HL2422110100130

Customer Care Center

For additional support, you can contact our Customer Care Center on: www.se.com/CCC

Technical Data

What's in This Part

Environment Data	283
Difference between Normal and Heavy duty	284
ATS480 and Motor Combination	285
Soft Starter Thermal Monitoring	291

Environment Data

Degree of protection	IEC 60529	<ul style="list-style-type: none"> • IP20 for ATS480D17Y to C11Y • IP00 for ATS480C14Y to M12Y 	
Vibration resistance	IEC 600068–2–6	<ul style="list-style-type: none"> • 1.5 mm peak to peak at 2 to 13 Hz • 10 m/s² (1g) at 13 to 200 Hz 	
Shock resistance	IEC 60068-2–27	150 m/s ² (15 g) during 11 ms	
Maximum ambient pollution degree	IEC 60664-1	Level 3	
Maximum relative humidity	IEC 60068–2–3	5...95% without condensation or dripping water	
Ambient temperature around the unit	Storage	-25...70 °C (-13...158 °F)	
	Operation:	-10...40 °C (14...104 °F)	No derating
		up to 60 °C (up to 140 °F)	Derate current by 2% each °C (1.8 °F)
Maximum operating altitude	0...1000m (0...3300ft)	No derating	
	1000...4000m (3300...13100ft)	Derate current by 1% each additional 100m (330ft)	
Operating position	Vertical at ± 10°		

Difference between Normal and Heavy duty

Depending on the type of machine, the applications are categorized as normal duty or heavy duty based on the starting characteristics, which are given as examples only in the table below.

Type of machine	Application	Functions performed by the Altivar Soft Starter ATS480	Starting current (% In)	Starting time (s)
Centrifugal pump	Normal duty	Deceleration (reduction in pressure surges) Detection of underload or reversal of phase rotation direction	300	5 to 15
Piston pump	Normal duty	Control of pump priming and direction of rotation	350	5 to 10
Fan	Normal duty Heavy duty if > 30 s	Detection of overloads caused by clogging or underloads (motor/fan transmission broken) Braking torque on stopping	300	10 to 40
Cold compressor	Normal duty	Monitoring, even for special motors	300	5 to 10
Screw compressor	Normal duty	Detection of reversal of phase rotation direction Contact for automatic draining on stopping	300	3 to 20
Centrifugal compressor	Normal duty Heavy duty if > 30 s	Detection of reversal of phase rotation direction Contact for automatic draining on stopping	350	10 to 40
Piston compressor	Normal duty	Detection of reversal of phase rotation direction Contact for automatic draining on stopping	350	5 to 10
Conveyor, transporter	Normal duty	Monitoring of overloads for incident detection or underloads for break detection	300	3 to 10
Lifting screw	Normal duty	Monitoring of overloads for hard spot detection or underloads for break detection	300	3 to 10
Drag lift	Normal duty	Monitoring of overloads for jamming detection or underloads for break detection	400	2 to 10
Lift	Normal duty	Monitoring of overloads for jamming detection or underloads for break detection Constant starting with variable load	350	5 to 10
Circular saw, band saw	Normal duty Heavy duty if > 30 s	Braking for fast stop	300	10 to 60
Pulper, butchery cutter	Heavy duty	Torque control on starting	400	3 to 10
Agitator	Normal duty	The current display indicates the density of the material	350	5 to 20
Mixer	Normal duty	The current display indicates the density of the material	350	5 to 10
Grinder	Heavy duty	Braking to limit vibrations during stopping, monitoring of overloads for jamming detection	450	5 to 60
Crusher	Heavy duty	Braking to limit vibrations during stopping, monitoring of overloads for jamming detection	400	10 to 40
Refiner	Normal duty	Torque control on starting and stopping	300	5 to 30
Press	Heavy duty	Braking to increase the number of cycles	400	20 to 60

ATS480 and Motor Combination

What's in This Chapter

Mains Supply in Function of the System Earthing Arrangement According to the Altitude	286
Normal Duty, Soft Starter In Line Connection, 208...690 Vac 50/60 Hz Supply	287
Normal Duty, Soft Starter Inside Delta Connection, 230...415 Vac 50/60 Hz Supply	288
Heavy Duty, Soft Starter In Line Connection, 208...690 Vac 50/60 Hz Supply	289
Heavy Duty, Soft Starter Inside Delta Connection, 230...415 Vac 50/60 Hz Supply	290

Mains Supply in Function of the System Earthing Arrangement According to the Altitude

Mains voltage	System earthing arrangement	Supply source overvoltage category required according to altitude (1)	
		Up to 2000 m (6600 ft)	From 2000 m to 4000 m (6600 ft to 13100 ft)
208...480 Vac	TT or TN	OVC III	OVC III
	IT or Corner-Grounded	OVC III	OVC II
480...600 Vac	TT or TN	OVC III	OVC II
	IT or Corner-Grounded	OVC III	OVC II
600...690 Vac	TT or TN	OVC III	OVC II
	IT or Corner-Grounded	OVC II	-
(1) according to IEC60947-1			

The supply source overvoltage category could be reduced by using an appropriate system such as an insulation transformer.

The altitude itself impacts the cooling of the soft starter:

- 0...1000 m (0...3300 ft) without derating of the rated operational current (I_e).
- 1000...4000 m (3300...13100 ft) with derating of the rated operational current (I_e) of 1% per 100 m (330 ft).

Normal Duty, Soft Starter In Line Connection, 208...690 Vac 50/60 Hz Supply

Motor									Soft starter (with no by-pass)	
Nominal motor power									Rated operational current I _e (1)	References
208 Vac	230 Vac		400 Vac	440 Vac	460 Vac	500 Vac	575 Vac	690 Vac		
HP	HP	kW	kW	kW	HP	kW	HP	kW	A	
3	5	4	7.5	7.5	10	9	15	15	17	ATS480D17Y
5	7.5	5.5	11	11	15	11	20	18.5	22	ATS480D22Y
7.5	10	7.5	15	15	20	18.5	25	22	32	ATS480D32Y
10	—	9	18.5	18.5	25	22	30	32	38	ATS480D38Y
—	15	11	22	22	30	30	40	37	47	ATS480D47Y
15	20	15	30	30	40	37	50	45	62	ATS480D62Y
20	25	18.5	37	37	50	45	60	55	75	ATS480D75Y
25	30	22	45	45	60	55	75	75	88	ATS480D88Y
30	40	30	55	55	75	75	100	90	110	ATS480C11Y
40	50	37	75	75	100	90	125	110	140	ATS480C14Y
50	60	45	90	90	125	110	150	160	170	ATS480C17Y
60	75	55	110	110	150	132	200	200	210	ATS480C21Y
75	100	75	132	132	200	160	250	250	250	ATS480C25Y
100	125	90	160	160	250	220	300	315	320	ATS480C32Y
125	150	110	220	220	300	250	350	400	410	ATS480C41Y
150	—	132	250	250	350	315	400	500	480	ATS480C48Y
—	200	160	315	355	400	400	500	560	590	ATS480C59Y
200	250	—	355	400	500	—	600	630	660	ATS480C66Y
250	300	220	400	500	600	500	800	710	790	ATS480C79Y
350	350	250	500	630	800	630	1000	900	1000	ATS480M10Y
400	450	355	630	710	1000	800	1200	—	1200	ATS480M12Y

The nominal motor current I_n must not exceed the rated operational current I_e

Those values are given without external bypass.

(1) Current on operation at a maximum ambient temperature of 40 °C (104 °F). Above 40 °C (104 °F) and up to an ambient temperature of 60 °C (140 °F), derate current by 2% each °C (1.8 °F).

Normal Duty, Soft Starter Inside Delta Connection, 230...415 Vac 50/60 Hz Supply

Motor		Soft starter (with no by-pass)	
Nominal motor power		Rated operational current I_e (1)	References
230 Vac	400 Vac		
kW	kW	A	
7.5	15	17	ATS480D17Y
9	18.5	22	ATS480D22Y
15	22	32	ATS480D32Y
18.5	30	38	ATS480D38Y
22	45	47	ATS480D47Y
30	55	62	ATS480D62Y
37	55	75	ATS480D75Y
45	75	88	ATS480D88Y
55	90	110	ATS480C11Y
75	110	140	ATS480C14Y
90	132	170	ATS480C17Y
110	160	210	ATS480C21Y
132	220	250	ATS480C25Y
160	250	320	ATS480C32Y
220	315	410	ATS480C41Y
250	355	480	ATS480C48Y
—	400	590	ATS480C59Y
315	500	660	ATS480C66Y
355	630	790	ATS480C79Y
—	710	1000	ATS480M10Y
500	—	1200	ATS480M12Y

The nominal motor current (I_n) divide by $\sqrt{3}$ **must not exceed the rated operational current (I_e)**.

Those values are given without external bypass.

(1) Current on operation at a maximum ambient temperature of 40 °C (104 °F). Above 40 °C (104 °F) and up to an ambient temperature of 60 °C (140 °F), derate current by 2% each °C (1.8 °F).

Heavy Duty, Soft Starter In Line Connection, 208...690 Vac 50/60 Hz Supply

Motor									Soft starter (with no by-pass)	
Nominal motor power									Rated operational current I _e (1)	References
208 Vac	230 Vac		400 Vac	440 Vac	460 Vac	500 Vac	575 Vac	690 Vac		
HP	HP	kW	kW	kW	HP	kW	HP	kW	A	
2	3	3	5,5	5,5	7.5	7.5	10	11	12	ATS480D17Y
3	5	4	7,5	7.5	10	9	15	15	17	ATS480D22Y
5	7.5	5,5	11	11	15	11	20	18.5	22	ATS480D32Y
7.5	10	7,5	15	15	20	18.5	25	22	32	ATS480D38Y
10	-	9	18,5	18.5	25	22	30	30	38	ATS480D47Y
-	15	11	22	22	30	30	40	37	47	ATS480D62Y
15	20	15	30	30	40	37	50	45	62	ATS480D75Y
20	25	18,5	37	37	50	45	60	55	75	ATS480D88Y
25	30	22	45	45	60	55	75	75	88	ATS480C11Y
30	40	30	55	55	75	75	100	90	110	ATS480C14Y
40	50	37	75	75	100	90	125	110	140	ATS480C17Y
50	60	45	90	90	125	110	150	160	170	ATS480C21Y
60	75	55	110	110	150	132	200	200	210	ATS480C25Y
75	100	75	132	132	200	160	250	250	250	ATS480C32Y
100	125	90	160	160	250	220	300	315	320	ATS480C41Y
125	150	110	220	220	300	250	350	400	410	ATS480C48Y
150	-	132	250	250	350	315	400	500	480	ATS480C59Y
-	200	160	315	355	400	400	500	560	590	ATS480C66Y
200	250	-	355	400	500	-	600	630	660	ATS480C79Y
250	300	220	400	500	600	500	800	710	790	ATS480M10Y
350	350	250	500	630	800	630	1000	900	1045	ATS480M12Y

The nominal motor current I_n must not exceed the rated operational current I_e

Those values are given without external bypass.

(1) Current on operation at a maximum ambient temperature of 40 °C (104 °F).
Above 40 °C (104 °F) and up to an ambient temperature of 60 °C (140 °F), derate current by 2% each °C (1.8 °F).

Heavy Duty, Soft Starter Inside Delta Connection, 230...415 Vac 50/60 Hz Supply

Motor		Soft starter (with no by-pass)	
Nominal motor power		Rated operational current I_e (1)	References
230 Vac	400 Vac		
kW	kW	A	
5.5	11	12	ATS480D17Y
7.5	15	17	ATS480D22Y
9	18.5	22	ATS480D32Y
15	22	32	ATS480D38Y
18.5	30	38	ATS480D47Y
22	45	47	ATS480D62Y
30	55	62	ATS480D75Y
37	55	75	ATS480D88Y
45	75	88	ATS480C11Y
55	90	110	ATS480C14Y
75	110	140	ATS480C17Y
90	132	170	ATS480C21Y
110	160	210	ATS480C25Y
132	220	250	ATS480C32Y
160	250	320	ATS480C41Y
220	315	410	ATS480C48Y
250	355	480	ATS480C59Y
—	400	590	ATS480C66Y
315	500	660	ATS480C79Y
355	630	790	ATS480M10Y
—	710	1045	ATS480M12Y

The nominal motor current (I_n) divide by $\sqrt{3}$ **must not exceed the rated operational current (I_e)**.

Those values are given without external bypass.

(1) Current on operation at a maximum ambient temperature of 40 °C (104 °F). Above 40 °C (104 °F) and up to an ambient temperature of 60 °C (140 °F), derate current by 2% each °C (1.8 °F).

Soft Starter Thermal Monitoring

Thermal monitoring is provided by the NTC sensor fitted on the heatsink (by calculating the temperature rise of the thyristors).

Glossary

D

Display terminal:

The Display Terminal is a local control unit plugged on the soft starter. The Display Terminal can be removed to be mounted on the door of the wall-mounted or floor-standing enclosure, using a dedicated door-mounting kit.

E

Error :

Discrepancy between a detected (computed, measured, or signaled) value or condition and the specified or theoretically correct value or condition.

F

Factory setting:

Machine status in factory settings when the product was shipped.

Fault Reset:

A function used to restore the soft starter to an operational state after a detected error is cleared by removing the cause of the error so that the error is no longer active.

Fault:

Fault is an operating state. If the monitoring functions detect an error, a transition to this operating state is triggered, depending on the error class. A "Fault reset" is required to exit this operating state after the cause of the detected error has been removed. Further information can be found in the pertinent standards such as IEC 61800-7, ODVA Common Industrial Protocol (CIP).

M

Monitoring function:

Monitoring functions acquire a value continuously or cyclically (for example, by measuring) in order to check whether it is within permissible limits. Monitoring functions are used for error detection.

N

NC contact:

Normally Closed contact

NO contact:

Normally Open contact

Normal Duty and Heavy Duty :

Normal duty and heavy duty are differentiated by the required overload that is defined by the following:

- Service duty: continuous or intermittent
- Service factor
- Overcurrent value
- Overcurrent duration

Each application duty has a corresponding motor protection class:

- Normal Duty → motor thermal protection class 10E
- Heavy Duty → motor thermal protection class 20E

For more examples, refer to *Difference between Normal and Heavy duty*, page 284.

O

OVCII:

Overvoltage Category II, according IEC 61800-5-1

P

Parameter:

Device data and values that can be read and set (to a certain extent) by the user.

PTC:

Positive Temperature Coefficient. PTC thermistor probes integrated in the motor or application to measure its temperature

S

SCPD:

Short-Circuit Protective Device

SCR: Silicon Controlled Rectifiers

T

TVS Diode:

Transient Voltage Suppression Diode

W

Warning:

If the term is used outside the context of safety instructions, a warning alerts to a potential error that was detected by a monitoring function. A warning does not cause a transition of the operating state.

Schneider Electric
35 rue Joseph Monier
92500 Rueil Malmaison
France

+ 33 (0) 1 41 29 70 00

www.se.com

As standards, specifications, and design change from time to time, please ask for confirmation of the information given in this publication.

© 2022 – 2026 Schneider Electric. All rights reserved.

NNZ85515.06 – 01/2026