

# Altivar Machine ATV340

## Variable Speed Drives

### PROFIsafe Manual – VW3A3807

Original Instructions

BRU32661.01  
03/2025



# Legal Information

The information provided in this document contains general descriptions, technical characteristics and/or recommendations related to products/solutions.

This document is not intended as a substitute for a detailed study or operational and site-specific development or schematic plan. It is not to be used for determining suitability or reliability of the products/solutions for specific user applications. It is the duty of any such user to perform or have any professional expert of its choice (integrator, specifier or the like) perform the appropriate and comprehensive risk analysis, evaluation and testing of the products/solutions with respect to the relevant specific application or use thereof.

The Schneider Electric brand and any trademarks of Schneider Electric SE and its subsidiaries referred to in this document are the property of Schneider Electric SE or its subsidiaries. All other brands may be trademarks of their respective owner.

This document and its content are protected under applicable copyright laws and provided for informative use only. No part of this document may be reproduced or transmitted in any form or by any means (electronic, mechanical, photocopying, recording, or otherwise), for any purpose, without the prior written permission of Schneider Electric.

Schneider Electric does not grant any right or license for commercial use of the document or its content, except for a non-exclusive and personal license to consult it on an "as is" basis.

Schneider Electric reserves the right to make changes or updates with respect to or in the content of this document or the format thereof, at any time without notice.

**To the extent permitted by applicable law, no responsibility or liability is assumed by Schneider Electric and its subsidiaries for any errors or omissions in the informational content of this document, as well as any non-intended use or misuse of the content thereof.**

# Table of Contents

About the document .....	5
Validity Note .....	6
Document Scope .....	7
Safety Information .....	8
Qualification of Personnel .....	9
Intended Use .....	9
Product Related Information .....	9
Related Documents .....	13
Terminology used in this document .....	15
Contact us .....	16
Structure of the Parameter Table .....	17
General System Description .....	18
Introduction .....	19
Certifications .....	22
Cyber Security .....	23
Basics .....	25
Safety Function Capability .....	29
Technical Data .....	31
Installation of the safety drive .....	32
Cable Routing Practices .....	34
Safety Functions .....	37
Safety function STO (Safe Torque Off) .....	38
Safety Function SS1 (Safe Stop 1) .....	39
Safety Function SLS (Safely Limited Speed) .....	43
Overview .....	43
Behavior of the Safety Function SLS - Type 1 .....	45
Behavior of the Safety Function SLS - Type 2 .....	46
Behavior of the Safety Function SLS - Type 3 .....	48
Behavior of the Safety Function SLS - Type 4 .....	50
Behavior of the Safety Function SLS - Type 5 .....	51
Behavior of the Safety Function SLS - Type 6 .....	53
Safety function SLS parameters .....	55
Safety Function SMS (Safe Maximum Speed) .....	57
Compatibility and Precedence of Safety Functions and Non-Safety- Related Functions .....	62
PROFIsafe index .....	70
Display .....	73
Dedicated Safety Functions menu in the Display Terminal .....	74
Commissioning and Display .....	80
Configuration of the safety system .....	81
Prerequisites to configure the safety drive .....	82
Commissioning the safety drive .....	83
Acceptance Test .....	96
Operation with PROFIsafe .....	98
Diagnostics and Troubleshooting .....	100
Operating states .....	101
Detected Errors .....	102

Maintenance and decommissioning .....	110
Remove or replace the safety drive .....	111
Remove or replace the safety controller.....	112
Clone the safety drive .....	113
Decommission the safety drive .....	114
Glossary .....	115

---

# About the document

## What's in This Part

Validity Note.....	6
Document Scope .....	7
Safety Information .....	8
Related Documents.....	13
Terminology used in this document.....	15
Contact us .....	16
Structure of the Parameter Table .....	17

## Validity Note

Original instructions and information given in the present document have been written in English (before optional translation).

This documentation is valid for the Altivar Machine ATV340 drives.

The characteristics of the products described in this document are intended to match the characteristics that are available on [www.se.com](http://www.se.com). As part of our corporate strategy for constant improvement, we may revise the content over time to enhance clarity and accuracy. If you see a difference between the characteristics in this document and the characteristics on [www.se.com](http://www.se.com), consider [www.se.com](http://www.se.com) to contain the latest information.

Step	Action
1	Go to the Schneider Electric home page <a href="http://www.se.com">www.se.com</a> .
2	In the <b>Search</b> box type the reference of the product or the name of a product range. <ul style="list-style-type: none"> <li>Do not include blank spaces in the reference or product range.</li> <li>To get information on grouping similar modules, use asterisks (*).</li> </ul>
3	If you entered a reference, go to the <b>Product Datasheets</b> search results and click on the reference that interests you.  If you entered the name of a product range, go to the <b>Product Ranges</b> search results and click on the product range that interests you.
4	If more than one reference appears in the <b>Products</b> search results, click on the reference that interests you.
5	Depending on the size of your screen, you may need to scroll down to see the data sheet.
6	To save or print a data sheet as a .pdf file, click <b>Download XXX product datasheet</b> .

## Information on Non-Inclusive or Insensitive Terminology

As a responsible, inclusive company, Schneider Electric is constantly updating its communications and products that contain non-inclusive or insensitive terminology. However, despite these efforts, our content may still contain terms that are deemed inappropriate by some customers.

# Document Scope

The purpose of this document is to provide information about the PROFIsafe module and supported safety functions.

# Safety Information

## What's in This Chapter

Qualification of Personnel .....9  
 Intended Use .....9  
 Product Related Information.....9

## Important Information

Read these instructions carefully, and look at the equipment to become familiar with the device before trying to install, operate, service, or maintain it. The following special messages may appear throughout this documentation or on the equipment to warn of potential hazards or to call attention to information that clarifies or simplifies a procedure.



The addition of this symbol to a “Danger” or “Warning” safety label indicates that an electrical hazard exists which will result in personal injury if the instructions are not followed.



This is the safety alert symbol. It is used to alert you to potential personal injury hazards. Obey all safety messages that follow this symbol to avoid possible injury or death.

<b>⚠ DANGER</b>
<b>DANGER</b> indicates a hazardous situation which, if not avoided, <b>will result in</b> death or serious injury.

<b>⚠ WARNING</b>
<b>WARNING</b> indicates a hazardous situation which, if not avoided, <b>could result in</b> death or serious injury.

<b>⚠ CAUTION</b>
<b>CAUTION</b> indicates a hazardous situation which, if not avoided, <b>could result in</b> minor or moderate injury.

<b>NOTICE</b>
<b>NOTICE</b> is used to address practices not related to physical injury.

## Please Note

Electrical equipment should be installed, operated, serviced, and maintained only by qualified personnel. No responsibility is assumed by Schneider Electric for any consequences arising out of the use of this material.

A qualified person is one who has skills and knowledge related to the construction and operation of electrical equipment and its installation, and has received safety training to recognize and avoid the hazards involved.

## Qualification of Personnel

Only appropriately trained persons who are familiar with and understand the contents of this manual and all other pertinent product documentation are authorized to work on and with this product. In addition, these persons must have received safety training to recognize and avoid hazards involved. These persons must have sufficient technical training, knowledge and experience and be able to foresee and detect potential hazards that may be caused by using the product, by changing the settings and by the mechanical, electrical and electronic equipment of the entire system in which the product is used. All persons working on and with the product must be fully familiar with all applicable standards, directives, and accident prevention regulations when performing such work.

## Intended Use

This product is intended for industrial use according to this manual.

The product may only be used in compliance with all applicable safety standard and local regulations and directives, the specified requirements and the technical data. The product must be installed outside the hazardous ATEX zone. Prior to using the product, you must perform a risk assessment in view of the planned application. Based on the results, the appropriate safety measures must be implemented. Since the product is used as a component in an entire system, you must ensure the safety of persons by means of the design of this entire system (for example, machine design). Any use other than the use explicitly permitted is prohibited and can result in hazards.

## Product Related Information

**Read and understand these instructions before performing any procedure with this device.**

### **DANGER**

#### **HAZARD OF ELECTRIC SHOCK, EXPLOSION OR ARC FLASH**

- Only appropriately trained persons who are familiar with and fully understand the contents of the present manual and all other pertinent product documentation and who have received all necessary training to recognize and avoid hazards involved are authorized to work on and with this device system.
- Installation, adjustment, repair and maintenance must be performed by qualified personnel.
- Verify compliance with all local and national electrical code requirements as well as all other applicable regulations with respect to grounding of all equipment.
- Only use properly rated, electrically insulated tools and measuring equipment.
- Do not touch unshielded components or terminals with voltage present.
- Prior to performing any type of work on the device system, block the motor shaft to prevent rotation.
- Insulate both ends of unused conductors of the motor cable.
- Do not short across the DC bus terminals or the DC bus capacitors or the braking resistor terminals.

**Failure to follow these instructions will result in death or serious injury.**

## ⚠️⚠️ DANGER

### HAZARD OF ELECTRIC SHOCK, EXPLOSION, OR ARC FLASH

Before performing work on the device system:

- Disconnect all power, including external control power that may be present. Take into account that the circuit breaker or main switch does not de-energize all circuits.
- Place a "Do Not Turn On" label on all power switches related to the device system.
- Lock all power switches in the open position.
- Wait 15 minutes to allow the DC bus capacitors to discharge.
- Verify the absence of voltage. (1)

Before applying voltage to the device system:

- Verify that the work has been completed and that the entire installation cannot cause hazards.
- If the mains input terminals and the motor output terminals have been grounded and short-circuited, remove the ground and the short circuits on the mains input terminals and the motor output terminals.
- Verify proper grounding of all equipment.
- Verify that all protective equipment such as covers, doors, grids is installed and/or closed.

**Failure to follow these instructions will result in death or serious injury.**

(1) Refer to Verifying the Absence of Voltage in the Installation manual of the product.

Damaged products or accessories may cause electric shock or unanticipated equipment operation.

## ⚠️⚠️ DANGER

### ELECTRIC SHOCK OR UNANTICIPATED EQUIPMENT OPERATION

Do not use damaged products or accessories.

**Failure to follow these instructions will result in death or serious injury.**

Contact your local Schneider Electric sales office if you detect any damage whatsoever.

This equipment has been designed to operate outside of any hazardous location. Only install this equipment in zones known to be free of a hazardous atmosphere.

## ⚠️ DANGER

### POTENTIAL FOR EXPLOSION

Install and use this equipment in non-hazardous locations only.

**Failure to follow these instructions will result in death or serious injury.**

Your application consists of a whole range of different interrelated mechanical, electrical, and electronic components, the device being just one part of the application. The device by itself is neither intended to nor capable of providing the entire functionality to meet all safety-related requirements that apply to your application. Depending on the application and the corresponding risk assessment to be conducted by you, a whole variety of additional equipment is required such as, but not limited to, external encoders, external brakes, external monitoring devices, guards, etc.

As a designer/manufacturer of machines, you must be familiar with and observe all standards that apply to your machine. You must conduct a risk assessment and determine the appropriate Performance Level (PL) and/or Safety Integrity Level (SIL) and design and build your machine in compliance with all applicable standards. In doing so, you must consider the interrelation of all components of the machine. In addition, you must provide instructions for use that enable the user of your machine to perform any type of work on and with the machine such as operation and maintenance in a safe manner.

The present document assumes that you are fully aware of all normative standards and requirements that apply to your application. Since the device cannot provide all safety-related functionality for your entire application, you must ensure that the required Performance Level and/or Safety Integrity Level is reached by installing all necessary additional equipment.

## ▲ WARNING

### INSUFFICIENT PERFORMANCE LEVEL/SAFETY INTEGRITY LEVEL AND/OR UNINTENDED EQUIPMENT OPERATION

- Conduct a risk assessment according to EN ISO 12100 and all other standards that apply to your application.
- Use redundant components and/or control paths for all critical control functions identified in your risk assessment.
- Implement all monitoring functions required to avoid any type of hazard identified in your risk assessment, for example, slipping or falling loads, in particular, if you do not operate the drive in closed loop mode which provides certain internal monitoring functions such as BRH3 [BRH b3], BRH4 [BRH b4] and BRH5 [BRH b5].
- Verify that the service life of all individual components used in your application is sufficient for the intended service life of your overall application.
- Perform extensive commissioning tests for all potential error situations to verify the effectiveness of the safety-related functions and monitoring functions implemented, for example, but not limited to, speed monitoring by means of encoders, short circuit monitoring for all connected equipment, correct operation of brakes and guards.
- Perform extensive commissioning tests for all potential error situations to verify that the load can be brought to a safe stop under all conditions.

**Failure to follow these instructions can result in death, serious injury, or equipment damage.**

A specific application note NHA80973 is available on hoisting machines and can be downloaded on [se.com](http://se.com).

Product may perform unexpected movements because of incorrect wiring, incorrect settings, incorrect data or other errors.

## ▲ WARNING

### UNANTICIPATED EQUIPMENT OPERATION

- Carefully install the wiring in accordance with the EMC requirements.
- Do not operate the product with unknown or unsuitable settings or data.
- Perform a comprehensive commissioning test.

**Failure to follow these instructions can result in death, serious injury, or equipment damage.**

## ▲ WARNING

### LOSS OF CONTROL

- The designer of any control scheme must consider the potential failure modes of control paths and, for critical control functions, provide a means to achieve a safe state during and after a path failure. Examples of critical control functions are emergency stop, overtravel stop, power outage and restart.
- Separate or redundant control paths must be provided for critical control functions.
- System control paths may include communication links. Consideration must be given to the implications of unanticipated transmission delays or failures of the link.
- Observe all accident prevention regulations and local safety guidelines (1).
- Each implementation of the product must be individually and thoroughly tested for proper operation before being placed into service.

**Failure to follow these instructions can result in death, serious injury, or equipment damage.**

(1) For USA: Additional information, refer to NEMA ICS 1.1 (latest edition), Safety Guidelines for the Application, Installation, and Maintenance of Solid State Control and to NEMA ICS 7.1 (latest edition), Safety Standards for Construction and Guide for Selection, Installation and Operation of Adjustable-Speed Drive Systems.

# Related Documents

Use your tablet or your PC to quickly access detailed and comprehensive information on all our products on [www.se.com](http://www.se.com).

The internet site provides the information you need for products and solutions:

- The whole catalog for detailed characteristics and selection guides,
- The CAD files to help design your installation, available in over 20 different file formats,
- All software and firmware to maintain your installation up to date,
- A large quantity of White Papers, Environment documents, Application solutions, Specifications... to gain a better understanding of our electrical systems and equipment or automation,
- And finally all the User Guides related to your drive, listed below:

Title of Documentation	Reference number	
ATV340 Catalog	DIA2ED2160701EN (English)	DIA2ED2160701FR (French)
ATV340 Getting Started - Video	FA367923 FAQ (English) 	
ATV340 Getting Started	NVE37643 (English) NVE37642 (French) NVE37644 (German) NVE37646 (Spanish)	NVE37647 (Italian) NVE37648 (Chinese) NVE37643PT (Portuguese)
ATV340 Getting Started Annex (SCCR)	NVE37641 (English)	
Wiring Diagrams for Frame Sizes S1, S2, S3	NVE97896 (English)	
ATV340 Installation Manual	NVE61069 (English) NVE61071 (French) NVE61074 (German) NVE61075 (Spanish)	NVE61078 (Italian) NVE61079 (Chinese) NVE61069PT (Portuguese) NVE61069TR (Turkish)
ATV340 Programming Manual	NVE61643 (English) NVE61644 (French) NVE61645 (German) NVE61647 (Spanish)	NVE61648 (Italian) NVE61649 (Chinese) NVE61643PT (Portuguese) NVE61643TR (Turkish)
ATV340 Modbus manual (Embedded)	NVE61654 (English)	
ATV340 Ethernet manual (Embedded)	NVE61653 (English)	
ATV340 DeviceNet manual (VW3A3609)	NVE61683 (English)	
Altivar dPAC Module user guide (VW3A3530D)	NNZ13577 (English)	
ATV340 PROFIsafe manual (VW3A3807)	BRU32661 (English)	
ATV340 PROFINET manual (VW3A3627)	NVE61678 (English)	
ATV340 PROFINET manual (VW3A3647)	BQT46621 (English)	
ATV340 CANopen manual (VW3A3608, 618, 628)	NVE61655 (English)	
ATV340 POWERLINK manual - (VW3A3619)	NVE61681 (English)	

Title of Documentation	Reference number
ATV340 EtherCAT manual - (VW3A3601)	NVE61686 (English)
ATV340 Communication Parameters	NVE61728 (English)
ATV340 Embedded Safety Function Manual	NVE64143 (English)
ATV340 DC Bus Sharing Technical Note PHA25027	PHA25027 (English)
ATV340 Safety functions Manual with Module VW3A3802	NVE61741 (English)      NVE61749 (Italian) NVE61742 (French)      NVE61752 (Chinese) NVE61745 (German)      NVE61741PT (Portuguese) NVE61747 (Spanish)      NVE61741TR (Turkish)
ATV340 CIP Safety functions manual with Module VW3A3809	JYT89148 (English)
Modicon M580, Safety Manual	QGH46982 (English)
SoMove FDT	SoMove_FDT (English, French, German, Spanish, Italian, Chinese)
Altivar 340: DTM	ATV340_DTM_Library_EN (English)      ATV340_DTM_Lang_SP (Spanish) ATV340_DTM_Lang_FR (French)      ATV340_DTM_Lang_IT (Italian) ATV340_DTM_Lang_DE (German)      ATV340_DTM_Lang_CN (Chinese)
Altivar Application Note for Hoisting	NHA80973 (English)
Recommended Cybersecurity Best Practices	CS-Best-Practices-2019-340 (English)
Schneider Electric VDMA66413 reliability values Libraries	Catolog: Reliability_values (English)
VW3A3647 PROFINet Certificate	VW3A3647 PROFINet Certificate (English)
PROFISAFE TUV certification	SAFETY MODULE TUV CERTIFICATE (English)

(Other option manuals and Instruction sheets are available on [www.se.com](http://www.se.com))

You can download these technical publications and other technical information from our website at [www.se.com/en/download](http://www.se.com/en/download)

# Terminology used in this document

The technical terms, terminology, and the corresponding descriptions in this manual normally use the terms or definitions in the relevant standards.

Among others, these standards include:

- ISO 13849: The Foundation of Functional Safety in the Machinery
- IEC 60204-1: Safety of machinery - Electrical equipment of machines – Part 1: General requirements.
- IEC 61010: Safety requirements for electrical equipment for measurement, control, and laboratory use.
- IEC 61158 series: Industrial communication networks - Fieldbus specifications
- IEC 61508 Ed.2 series: Functional safety of electrical/electronic/programmable electronic safety-related.
- IEC 61784 series: Industrial communication networks - Profiles.
- IEC 61784-5-3: Industrial communication networks - Profiles - Part 5-3: Installation of fieldbuses - Installation profiles for CPF 3
- IEC 61800 series: Adjustable speed electrical power drive systems.
- IEC 61918: Industrial communication networks - Installation of communication networks in industrial premises.
- IEC 62443: Security for industrial automation and control systems.

In the area of drive systems this includes, but is not limited to, terms such as **error**, **error message**, **failure**, **fault**, **fault reset**, **protection**, **safe state**, **safety function**, **warning**, **warning message**, and so on.

In addition, the term **zone of operation** is used in conjunction with the description of specific hazards, and is defined as it is for a **hazard zone** or **danger zone** in the EC Machinery Directive (2006/42/EC) and in ISO 12100-1.

## Contact us

Select your country on [www.se.com/contact](http://www.se.com/contact).

Schneider Electric Industries SAS

Head Office



35, rue Joseph Monier

92500 Rueil-Malmaison

France

# Structure of the Parameter Table

## General Legend

Pictogram	Description
	Power cycle must be performed after setting this parameter.
	Read only parameter, mainly used for monitoring.
	Expert mode required to access this parameter.

# General System Description

## What's in This Part

Introduction.....	19
Certifications.....	22
Cyber Security .....	23
Basics .....	25
Safety Function Capability .....	29

# Introduction

## Overview

The safety function STO (Safe Torque Off) does not remove power from the DC bus. The safety function STO only removes power to the motor. The DC bus voltage and the mains voltage to the safety drive are still present.

### DANGER

#### HAZARD OF ELECTRIC SHOCK

- Do not use the safety function STO for any other purposes than its intended function.
- Use an appropriate switch, that is not part of the circuit of the safety function STO, to disconnect the product from the mains power.

**Failure to follow these instructions will result in death or serious injury.**

### WARNING

#### INSUFFICIENT DECELERATION OR UNINTENDED EQUIPMENT OPERATION

Verify that decelerating in freewheel when the safety function STO is triggered does not result in unsafe conditions.

**Failure to follow these instructions can result in death, serious injury, or equipment damage.**

When the safety function STO is triggered, the power stage is immediately disabled. In the case of vertical applications or external forces acting on the motor shaft, you may have to take additional measures to bring the motor to a standstill and to keep it at a standstill when the safety function STO is used, for example, by using a service brake.

### WARNING

#### INSUFFICIENT DECELERATION OR UNINTENDED EQUIPMENT OPERATION

- Verify that using the safety function STO does not result in unsafe conditions.
- If standstill is required in your application, ensure that the motor comes to a secure standstill when the safety function STO is used.

**Failure to follow these instructions can result in death, serious injury, or equipment damage.**

## ⚠ WARNING

### INEFFECTIVE SAFETY FUNCTIONS

- Verify that a risk assessment as per ISO 12100-1 and/or any other equivalent assessment has been performed before this product is used.
- Verify that only persons who are trained and certified experts in safety engineering and who are familiar with all safety-related standards, provisions, and regulations such as, but not limited to, IEC 61800-5-2 work with this product.
- Verify that only persons who are thoroughly familiar with the safety-related applications and the non-safety-related applications as well as the hardware used to operate the machine/process, work with this product.
- After any transfer of safety configuration to the safety drive, verify the correct operation and effectiveness of all functions by performing comprehensive tests for all operating states, the defined safe state, and all potential error situations.

**Failure to follow these instructions can result in death, serious injury, or equipment damage.**

## ⚠ WARNING

### UNANTICIPATED EQUIPMENT OPERATION

- Only start the machine/process if there are no persons or obstructions in the zone of operation.
- Only make modifications of any type whatsoever, including, but not limited to, parameter values, settings, configurations, hardware, if you fully understand all effects of such modifications.
- Verify that modifications do not compromise or reduce the Safety Integrity Level (SIL), Performance Level (PL) and/or any other safety-related requirements and capabilities defined for your machine/process.
- After modifications of any type whatsoever, restart the machine/process and verify the correct operation and effectiveness of all functions by performing comprehensive tests for all operating states, the defined safe state, and all potential error situations.
- If you have to commission or recommission the machine/process, perform a commissioning test pursuant to all regulations, standards, and process definitions applicable to your machine/process.
- Document all modifications in compliance with all regulations, standards, and process definitions applicable to your machine/process.

**Failure to follow these instructions can result in death, serious injury, or equipment damage.**

PROFIsafe module (VW3A3807) provides networked safety functions via a PROFInet network.

The safety functions supported by the safety module VW3A3807 are intended to maintain the safe condition or prevent hazardous conditions. In some cases, external safety-related systems (for example a mechanical brake) may be necessary to maintain the safe condition when electrical power is removed.

The configuration of the PROFIsafe module can only be done via the commissioning software TIA Portal and Altivar DTM.

The PROFIsafe module is compliant with the software version from **V4.3** of Altivar Machine ATV340 drives. If this requirement is not respected, an **[Internal Error 6] INF6** is triggered. For more information about **[Internal Error 6] INF6**, refer to Detected Errors.

The Altivar Machine ATV340 drives are compliant with the requirements of the standards in terms of implementation of the safety functions.

The term "safety drive" which is used in this document refers to the drive with the PROFIsafe module inserted.

## Supported Safety Functions as Defined by IEC 61800-5-2

Acro-nym	Description
<b>STO</b>	<b>Safe Torque Off</b> No power that could cause torque or force is supplied to the motor.
<b>SMS</b>	<b>Safe Maximum Speed</b> The safety function SMS prevents the speed of the motor from exceeding the specified speed limit. If the motor speed exceeds the specified speed limit value, safety function STO or SS1 is triggered. The safety function SMS does not limit the frequency reference value.
<b>SLS</b>	<b>Safely-Limited Speed</b> The safety function SLS prevents the motor from exceeding the specified speed limit. If the motor speed exceeds the specified speed limit value, safety function STO is triggered.
<b>SS1</b>	<b>Safe Stop 1</b> <ul style="list-style-type: none"><li>• Initiates and monitors the motor deceleration rate within set limits to stop the motor.</li><li>• Triggers the safety function STO when the motor speed is below the specified limit.</li></ul>

# Certifications

## EC Declaration of Conformity

The EC Declaration of Conformity for the EMC Directive can be obtained on [www.se.com](http://www.se.com).

## Functional Safety Certification

The integrated safety functions are compatible and certified according to IEC 61800-5-2 Ed.2 Adjustable speed electrical power drive systems - Part 5-2: Safety requirements - Functional.

IEC 61800-5-2, as a product standard, sets out safety-related considerations of Power Drive System Safety Related PDS (SR)s in terms of the framework of the IEC 61508 Ed.2 series of standards.

Compliance with the IEC 61800-5-2 standard, for the safety functions described below, facilitate incorporation of a PDS (SR) (Power Drive System suitable for use in safety-related applications) into a safety-related control system using the principles of IEC 61508, or IEC 13849-1, as well as IEC 62061 for process systems and machinery.

The defined safety functions are:

- SIL3 capability in compliance with IEC 61800-5-2 and the IEC 61508 Ed.2 series.
- Performance level d and e in compliance with ISO 13849-1.
- Compliant with Category 3 of ISO 13849-1.

Also refer to safety function Capability.

The safety demand operating mode is considered to be high demand or continuous mode of operation according to the IEC 61800-5-2 standard.

The functional safety certificate is accessible on [SAFETY MODULE TUV CERTIFICATE](#).

# Cyber Security

## Overview

The objective of Cybersecurity is to help provide increased levels of protection for information and physical assets from theft, corruption, misuse, or accidents while maintaining access for their intended users.

No single Cybersecurity approach is adequate. Schneider Electric recommends a defense-in-depth approach. Conceived by the National Security Agency (NSA), this approach layers the network with security features, appliances, and processes.

The basic components of this approach are:

- Risk assessment
- A security plan built on the results of the risk assessment
- A multi-phase training campaign
- Physical separation of the industrial networks from enterprise networks using a demilitarized zone (DMZ) and the use of firewalls and routing to establish other security zones
- System access control
- Device hardening
- Network monitoring and maintenance

## Protected Environment Assumptions

Machines, controllers, and related equipment are usually integrated into networks. Unauthorized persons and malware may gain access to the machine as well as to other devices on the network/fieldbus of the machine and connected networks via insufficiently secure access to software and networks.

<b>▲ WARNING</b>
<p><b>UNAUTHORIZED ACCESS TO THE MACHINE VIA SOFTWARE AND NETWORKS</b></p> <ul style="list-style-type: none"> <li>• In your hazard and risk analysis, consider all hazards that result from access to and operation on the network/fieldbus and develop an appropriate cyber security concept.</li> <li>• Verify that the hardware infrastructure and the software infrastructure into which the machine is integrated as well as all organizational measures and rules covering access to this infrastructure consider the results of the hazard and risk analysis and are implemented according to best practices and standards covering IT security and cyber security (such as: ISO/IEC 27000 series, Common Criteria for Information Technology Security Evaluation, ISO/ IEC 15408, IEC 62351, ISA/IEC 62443, NIST Cybersecurity Framework, Information Security Forum - Standard of Good Practice for Information Security, SE recommended Cybersecurity Best Practices*).</li> <li>• Verify the effectiveness of your IT security and cyber security systems using appropriate, proven methods.</li> </ul> <p><b>Failure to follow these instructions can result in death, serious injury, or equipment damage.</b></p>

(\*) : SE Recommended Cybersecurity Best Practices can be downloaded on SE.com.

## Security Policy

The device does not have the capability to transmit data encrypted using the following protocols: HTTP, Modbus slave over serial, Modbus slave over Ethernet, EtherNet/IP, PROFINet, SNMP, SNTP. If other users gained access to your network, transmitted information can be disclosed or subject to tampering.

### **⚠ WARNING**

#### **CYBERSECURITY HAZARD**

- For transmitting data over an internal network, physically or logically segment the network, the access to the internal network needs to be restricted by using standard controls such as firewalls.
- For transmitting data over an external network, encrypt protocol transmissions over all external connections using an encrypted tunnel, TLS wrapper or a similar solution.

**Failure to follow these instructions can result in death, serious injury, or equipment damage.**

For detailed information about cybersecurity policy for the PROFIsafe environment, please refer to the *ATV340 Programming manual*.

# Basics

## Functional Safety

Automation and safety engineering are two areas that were completely separate in the past but have recently become more and more integrated.

The engineering and installation of complex automation solutions are greatly simplified by integrated safety functions.

Usually, the safety engineering requirements depend on the application.

The level of requirements results from the risk and the hazard potential arising from the specific application.

## IEC 61508 Standard

The standard IEC 61508 Functional safety of electrical/electronic/programmable electronic safety-related systems covers the safety-related function.

Instead of a single component, an entire function chain (for example, from a sensor through the logical processing units to the actuator) is considered as a unit.

This function chain must meet the requirements of the specific safety integrity level as a whole.

Systems and components that can be used in various applications for safety tasks with comparable risk levels can be developed on this basis.

## SIL - Safety Integrity Level

The standard IEC 61508 defines 4 safety integrity levels (SIL) for safety functions.

SIL1 is the lowest level and SIL4 is the highest level.

A hazard and risk analysis serves as a basis for determining the required safety integrity level.

This is used to decide whether the relevant function chain is to be considered as a safety function and which hazard potential it must cover.

## PFH - Probability of a Dangerous Hardware Failure Per Hour

To maintain the safety function, the IEC 61508 standard requires various levels of measures for avoiding and controlling detected faults, depending on the required SIL.

All components of a safety function must be subjected to a probability assessment to evaluate the effectiveness of the measures implemented for controlling detected faults.

This assessment determined the PFH (Average frequency of dangerous failure) for a safety system.

This is the probability per hour that a safety system fails in a hazardous manner and the safety function cannot be correctly executed.

Depending on the SIL, the PFH must not exceed certain values for the entire safety system.

The individual PFH values of a function chain are added. The result must not exceed the maximum value specified in the standard.

Safety Integrity Level	Average frequency of dangerous failure (PFH) at high demand or continuous demand
4	$\geq 10^{-9} \dots < 10^{-8}$
3	$\geq 10^{-8} \dots < 10^{-7}$
2	$\geq 10^{-7} \dots < 10^{-6}$
1	$\geq 10^{-6} \dots < 10^{-5}$

## PL - Performance Level

The standard ISO 13849-1 defines 5 Performance levels (PL) for safety functions.

a is the lowest level and e is the highest level.

Five levels (a, b, c, d, and e) correspond to different values of Average frequency of dangerous failure.

Performance level	Probability of a dangerous Hardware Failure per Hour
e	$\geq 10^{-8} \dots < 10^{-7}$
d	$\geq 10^{-7} \dots < 10^{-6}$
c	$\geq 10^{-6} \dots < 3 * 10^{-6}$
b	$\geq 3 * 10^{-6} \dots < 10^{-5}$
a	$\geq 10^{-5} \dots < 10^{-4}$

## HFT - Hardware Fault Tolerance and SFF - Safe Failure Fraction

Depending on the SIL for the safety system, the IEC 61508 standard requires a specific hardware fault tolerance HFT in connection with a specific proportion of safe failures SFF (Safe Failure Fraction).

The hardware fault tolerance is the ability of a system to execute the required safety function in spite of the presence of one or more hardware faults.

The SFF of a system is defined as the ratio of the rate of safe failures and dangerous detected failures to the total failure rate of the system.

$$\text{SFF} = (\Sigma\lambda_s + \Sigma\lambda_{Dd}) / (\Sigma\lambda_s + \Sigma\lambda_{Dd} + \Sigma\lambda_{Du})$$

$\Sigma\lambda_s$ : Safe failures

$\Sigma\lambda_{Dd}$ : Dangerous detected failures

$\Sigma\lambda_{Du}$ : Dangerous undetected failures

According to IEC 61508, the maximum achievable SIL of a system is partly determined by the hardware fault tolerance HFT and the safe failure fraction SFF of the system.

IEC 61508 distinguishes two types of subsystem (type A subsystem, type B subsystem).

These types are specified on the basis of criteria which the standard defines for the safety-relevant components.

SFF	HFT type A subsystem			HFT type B subsystem		
	0	1	2	0	1	2
< 60%	SIL1	SIL2	SIL3	—	SIL1	SIL2
60%...< 90%	SIL2	SIL3	SIL4	SIL1	SIL2	SIL3
90%...< 99%	SIL3	SIL4	SIL4	SIL2	SIL3	SIL4
≥99%	SIL3	SIL4	SIL4	SIL3	SIL4	SIL4

## PFD - Probability of Failure on Demand

The standard IEC 61508 defines SIL using requirements grouped into two broad categories: hardware safety integrity and systematic safety integrity. A device or system must meet the requirements for both categories to achieve a given SIL.

The SIL requirements for hardware safety integrity are based on a probabilistic analysis of the device. To achieve a given SIL, the device must meet targets for the maximum probability of dangerous failure and a minimum Safe Failure Fraction. The concept of 'dangerous failure' must be rigorously defined for the system in question, normally in the form of requirement constraints whose integrity is verified throughout system development. The actual targets required vary depending on the likelihood of a demand, the complexity of the device(s), and types of redundancy used.

The PFD (Probability of Failure on Demand) and RRF (Risk Reduction Factor) of low demand operation for different SILs are defined in IEC 61508 are as follows:

SIL	PFD	PFH (power of ten)	RRF
1	0.1 - 0.01	10 <sup>-1</sup> - 10 <sup>-2</sup>	10 - 100
2	0.01 - 0.001	10 <sup>-2</sup> - 10 <sup>-3</sup>	100 - 1000
3	0.001 - 0.0001	10 <sup>-3</sup> - 10 <sup>-4</sup>	1000 - 10,000
4	0.0001 - 0.00001	10 <sup>-4</sup> - 10 <sup>-5</sup>	10,000 - 100,000

In high demand or continuous operation, these changes to the following:

SIL	PFH	PFH (power of ten)	RRF
1	0.00001 - 0.000001	10 <sup>-5</sup> - 10 <sup>-6</sup>	100,000 - 1,000,000
2	0.000001 - 0.0000001	10 <sup>-6</sup> - 10 <sup>-7</sup>	1,000,000 - 10,000,000
3	0.0000001 - 0.00000001	10 <sup>-7</sup> - 10 <sup>-8</sup>	10,000,000 - 100,000,000
4	0.00000001 - 0.000000001	10 <sup>-8</sup> - 10 <sup>-9</sup>	100,000,000 - 1,000,000,000

The hazards of a control system must be identified then analyzed in a risk analysis. These risks are gradually mitigated until their overall contribution to the hazard is deemed to be acceptable. The tolerable level of these risks is specified as a safety requirement in the form of a target probability of a dangerous failure over a given period, stated as a discrete SIL level.

## Fault Avoidance Measures

Systematic errors in the specifications, in the hardware and the software, usage faults and maintenance faults in the safety system must be avoided to the maximum degree possible. To meet these requirements, IEC 61508 specifies a number of measures for fault avoidance that must be implemented depending on the required SIL. These measures for fault avoidance must cover the entire life cycle of the safety system, i.e. from design to decommissioning of the system.

# Safety Function Capability

## PDS (SR) Safety Functions are Part of an Overall System

If the qualitative and quantitative safety objectives determined by the final application require some adjustments to ensure safe use of the safety functions, the integrator of the BDM (Basic Drive Module) is responsible for these additional changes (for example, managing the mechanical brake on the motor).

Also, the output data generated by the use of safety functions (fault relay activation, error codes, or information on the display, and so on) is not considered to be safety-related data.

## SIL and PL Table for the Safety Functions

The following table provides the SIL and PL details for the safety functions of the PROFIsafe module:

Safety Function	Opened/Closed loop safety configuration	Safety integrity level (SIL)	Performance Level (PL)
SS1	Opened	SIL2	PL d
SLS SMS	Closed	SIL3	PL e
STO	-	SIL3	PL e

**Note:** Verify that all the components used in the application that have different SIL Level (mix Level) reach the intended level for the Overall Application by performing comprehensive tests for all operating states, the defined safe state, and all potential error situations.

## Summary of the Reliability Study — STO —

The following table provides the SIL and PL details for the safety functions of the PROFIsafe module:

Safety Function	Standard	Attribute	Value
STO	IEC 61508 Ed.2	SFF	>90%
		PFD20y	6,40 <sup>-05</sup>
		PFHequ_1y	3,2.10 <sup>-10</sup> (1)
			4,7.10 <sup>-10</sup> (2)
		PTI	1
		Type	B
	ISO 13849-1	HFT	1
		DC	>90%
		Category	3
		MTTFd in years	>100
(1) For drives with power range equal to or less than 22 kW.			
(2) For drives with power range equal to or greater than 30 kW.			

## Summary of the Reliability Study — SS1, SLS, SMS —

The following table provides the SIL and PL details for the safety functions of the safety module according to IEC 61508 and ISO 13849:

Function	Standard	Type of Motor and controls	Asynchronous motor in Open loop safety configuration	Asynchronous or Synchronous <sup>(3)</sup> motor in Closed loop safety configuration
SS1, SLS, SMS	IEC 61508 Ed.2	SFF	>90%	>90%
		PFD <sub>20y</sub>	3.8.10 <sup>-3</sup> (6)	1.10 <sup>-4</sup> (6)
			5.2.10 <sup>-3</sup> (7)	2.1.10 <sup>-4</sup> (7)
		PFH <sub>equ_1y</sub>	28 FIT (1)(6)	0.87 FIT (1)(6)
			44 FIT (1)(7)	1.3 FIT (1)(7)
		PTI	1	1
		Type	B	B
		HFT	0	1
	DC	>90%	>90%	
	SIL capability	2	3	
	IEC 62061 (2)	SIL CL capability	2	3
	IEC 60204-1	Category stop	1 for SS1	1 for SS1
	ISO 13849-1 (4)	PL	d	e
		Category	2	3
MTTFd in years		82 (5)	75	

(1) FIT: Failure In Time = 10<sup>-9</sup> failure per hour.

(2) Because the IEC 62061 standard concerns integration, this standard distinguishes the overall safety function (which is classified SIL2 or SIL3 for ATV340/ATV900 according to diagrams Process system SF - Case 1 and Process system SF - Case 2, from components which constitute the safety function (which is classified SIL2 CL or SIL3 CL for ATV340/ATV900).

(3) Permanent magnets synchronous motors. Reluctance motors are not covered by the safety module.

(4) According to EN 13849-1:2015.

(5) MTTFD of STO function is not taken into account

(6) For drives with power range equal to or less than 22 kW.

(7) For drives with power range equal to or greater than 30 kW.

Preventive annual activation of the safety function is recommended.

However, the safety levels can be obtained (with lower margins) without annual activation.

**NOTE:** The table above is not sufficient to evaluate the PL of a PDS. The PL evaluation has to be done at the system level. The fitter or the integrator of the BDM (Basic Drive Module) has to do the system PL evaluation by including sensors data with numbers from the table above.

**NOTE:** In case of closed loop control, the value given in the preceding table can be reached if the SIL of the used encoder is at least SIL2 according to standard IEC 61508. For mechanical coupling, the shape of this safety encoder and the motor shaft must fit together.

---

# Technical Data

## What's in This Part

Installation of the safety drive .....	32
Cable Routing Practices .....	34

# Installation of the safety drive

## Before You Begin

Before you install the module, ensure that the

- Catalog number given on the label of the module is the same as that on the delivery note corresponding to the purchase order
- PROFIsafe module is not damaged
- Additional module support (VW3A3800) is available.
- The PROFINet module VW3A3647 is inserted, and the PROFINet FW version compatible with PROFIsafe is **V3.2IE12**.
- Software version of the drive is compatible with the PROFIsafe module.
- The drive software version compatible with PROFIsafe is the **V4.3**.

This version can be downloaded at [ATV340 Product Firmware](#) and the firmware update can be done through the [Ecostruxure Automation Device Maintenance User Manual](#). If the firmware package is not available, contact your local Schneider Electric Service.

- Both the drive configuration (see [ATV340 Programming manual](#)) and PROFIsafe module configuration (see [Reset safety configuration of the safety drive](#)) must be reset to clear any previous configuration due to incompatibility with the drive software version supporting the PROFIsafe.
- The drive is correctly set up with the correct speed loop and torque characteristics for the application; the reference frequency profile applied to the drive control loop is followed.

**NOTE:** All network devices used in conjunction with this safety drive shall meet the requirements of IEC 61010-1 or IEC 61010-2-201 (for example PELV).

## Mechanical data

### Weight:

- PROFIsafe module VW3A3807 : 0.02 kg (0.044 lb)
- Additional Module Support VW3A3800: 0.4 kg (0.89 lb)

### Dimensions:

- PROFIsafe module VW3A3807: 41 x 109 x 23.25 mm (1.61 x 4.29 x 0.91 in)
- Additional Module Support VW3A3800: 128 x 147 x 65 mm (5.04 x 5.79 x 2.56 in)
- The use of an additional module support increases the depth values of the drive by maximum of 50.5 mm (1.97 in) depending on the catalog number of the drive. The additional module support takes place between the Graphic Display Terminal and the drive, causing the depth value to be increased.

## Ambient Conditions

The ambient conditions to be met for the PROFIsafe module correspond to the ambient conditions for the drive, see the [installation manual](#) of the drive.

**▲ WARNING****LOSS OF SAFETY FUNCTION CAUSED BY FOREIGN OBJECTS**

Conductive foreign objects, dust or liquids may cause safety functions to become inoperative.

- Do not use a safety function unless you have protected the system against contamination by conductive substances.

**Failure to follow these instructions can result in death, serious injury, or equipment damage.**

## Installation of the Additional module support (VW3A3800)

Refer to the Additional module support Instruction Sheet (NHA80733) to install the Additional module support on the drive.

## Installation or removal of the PROFIsafe module (VW3A3807)

The PROFIsafe module VW3A3807 can only be recognized on the slot proposed by the additional module support (Only needed for ATV340 with power range equal to or higher than 30 kW (40 HP)). Install the additional module support before installing the PROFIsafe module.

Refer to the PROFIsafe Module Instruction Sheet (JYT89145) to install or remove the PROFIsafe module from the drive.

## Degree of protection

The safety drive must be installed in a control cabinet with degree of protection IP54 (or higher). This is required to avoid cross faults and short circuits between terminals, connectors, tracks and safety-related circuitry caused by foreign objects.

# Cable Routing Practices

## Installation Topology

The PROFINet VW3A3807 option module enables several architecture solutions:

- **Daisy chain topology**
- **Star topology**
- **Ring topology**

**NOTE:**

- Single port routers are not allowed with PROFINet.
- Ethernet-Switches shall be suitable for standard industrial environment as defined for example in IEC 61010-2-201.

**NOTE:** the PROFINet module must be unplugged before installing the architecture.

## Daisy chain Topology

- **Physical architecture:**

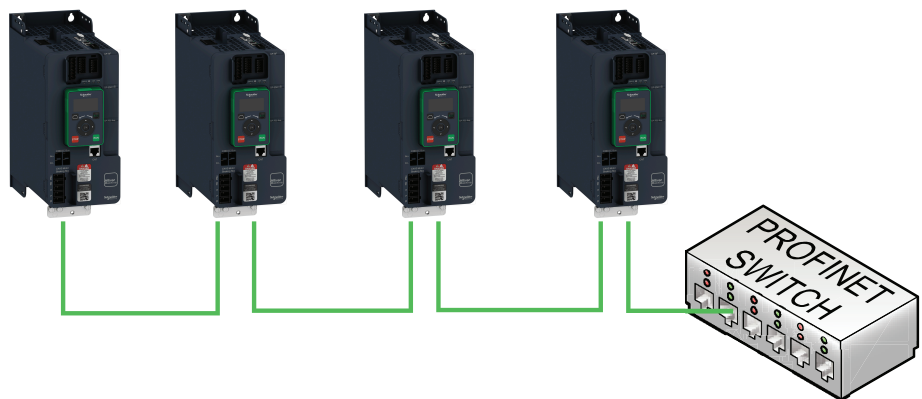

- **Daisy chain topology on TIA Portal:**

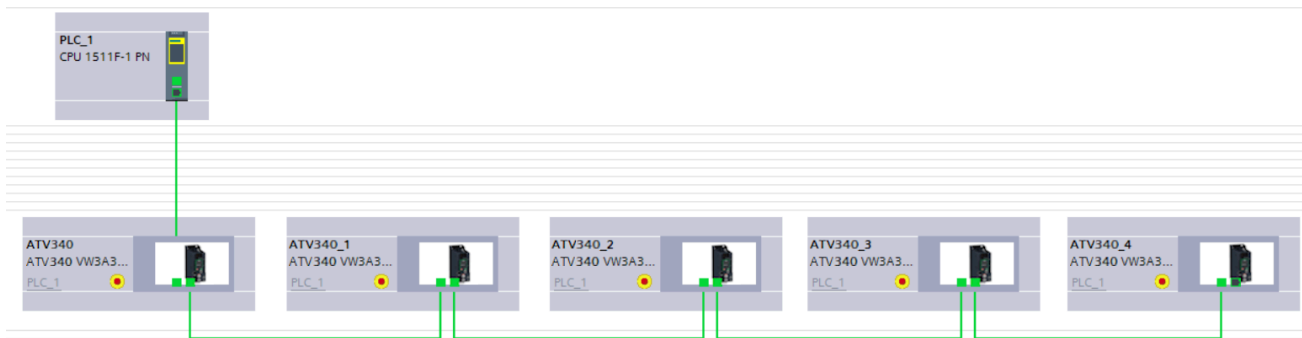

# Star Topology

- Physical architecture:

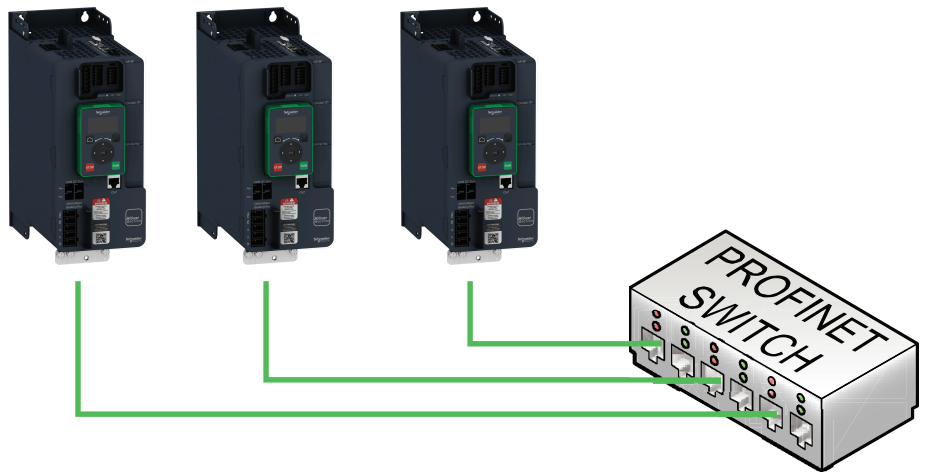

- Star topology on TIA Portal:

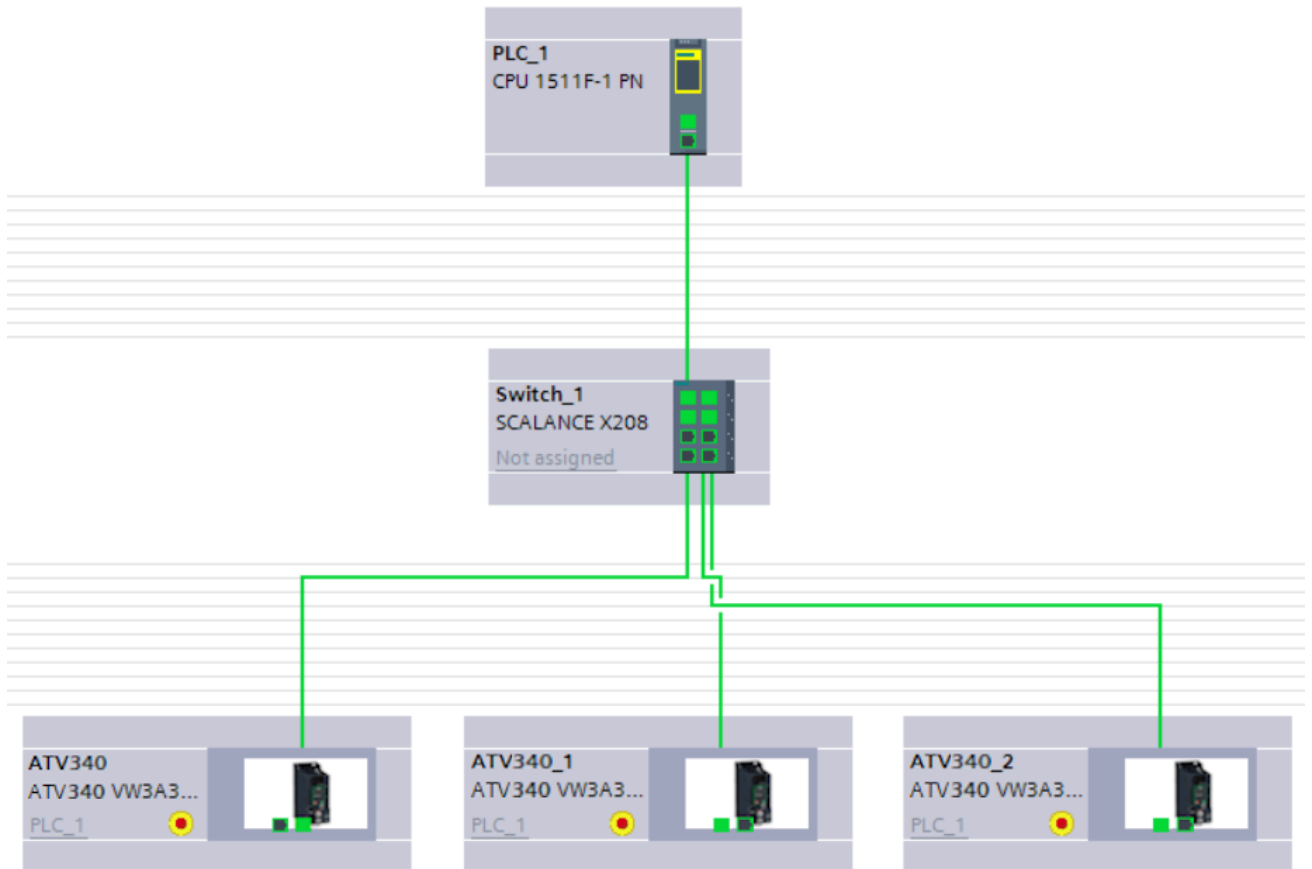

## Ring Topology

- **Physical architecture:**

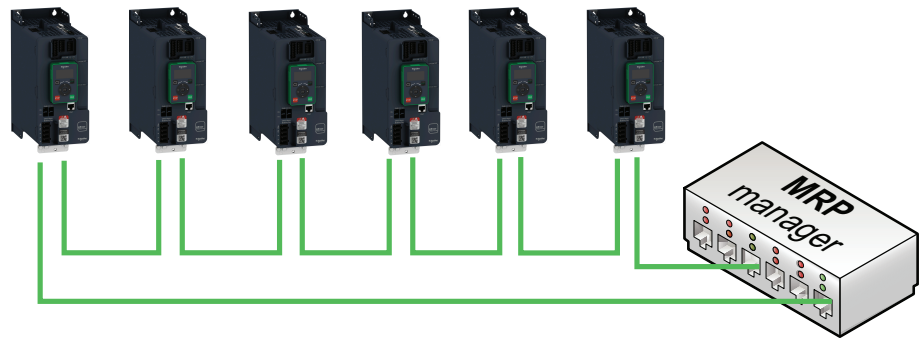

- **Ring Topology on TIA Portal:**

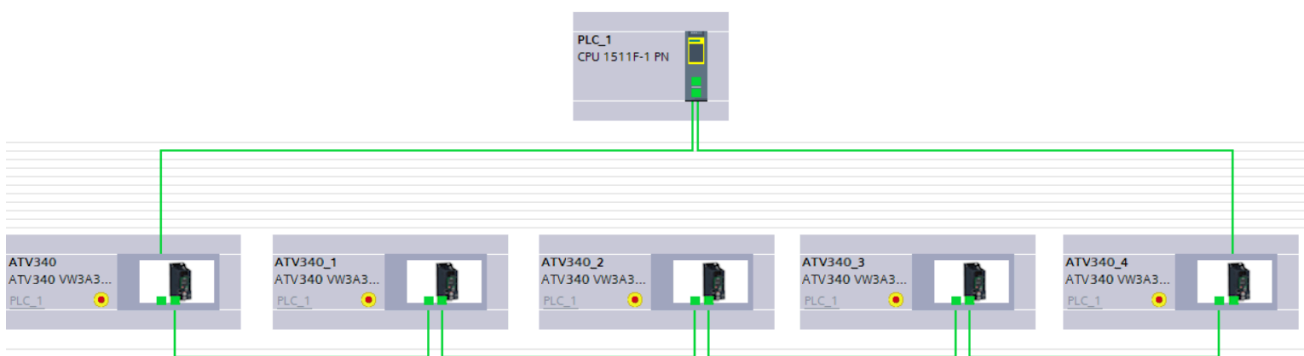

The ring topology can only be used with a media redundancy protocol (MRP) capable managed device.

---

# Safety Functions

## What's in This Part

Safety function STO (Safe Torque Off) .....	38
Safety Function SS1 (Safe Stop 1) .....	39
Safety Function SLS (Safely Limited Speed) .....	43
Safety Function SMS (Safe Maximum Speed) .....	57
Compatibility and Precedence of Safety Functions and Non-Safety-Related Functions.....	62
PROFIsafe index .....	70
Display .....	73
Dedicated Safety Functions menu in the Display Terminal .....	74

## Safety function STO (Safe Torque Off)

STO is a Safe Torque Off defined by IEC 61800-5-2.

The Safe Torque Off (STO) function is the standard function embedded to the drive. Refer to the Embedded Safety Function manual of the drive for further information.

The PROFIsafe module is an option module of the drive. If the PROFIsafe module is inserted then the safety function STO cannot be activated with the STO inputs of the drive (**STOA** and **STOB**). In this case, the STO inputs of the drive (**STOA** and **STOB**) must be short-circuited to 24V. Otherwise, a **[Unexpected STO]** **SMEOD4** is triggered by the PROFIsafe module when safe torque off is released via the PROFIsafe Telegram .

# Safety Function SS1 (Safe Stop 1)

## Overview

The safety function SS1 monitors the motor frequency deceleration and safely shuts off the torque (STO function) once the standstill has been reached.

In addition of the deceleration monitoring, the safety module can control the motor frequency deceleration depending on the setting value of the parameter **[SS1 drive control]** [SC36](#):

- **External**: the deceleration of the frequency reference value must be done via the safety controller. Without modification of the reference frequency, there is no deceleration and the monitoring deceleration ramp is violated.
- **Automatic**: the deceleration of frequency reference value follows a ramp defined by the parameter **[SS1 commanded deceleration]** [SC30](#) of the safety module.

The safety function SS1 can be activated via the safety telegram output.

SS1 can also be activated via another safety function SLS (type 3 and type 6).

To use the safety module, the safety function SS1 must be configured.

**NOTE:** After SS1, the power stage is locked. If the source of SS1 activation has been deactivated before its completion, the PROFIsafe module completes SS1 but remains in STO for only a short time (100ms), then automatically removes the STO.

**NOTE:** In case of an open loop motor control, if the power stage is disabled (such as during a freewheel stop), the motor frequency is not monitored by the PROFIsafe module, the SS1 function is stopped and STO is applied by the safety module.

## Behavior on Activation of the Safety Function SS1

At SS1 activation:

- Depending on **[SS1 drive control]** [SC36](#):
  - With EXTERNAL trig, the motor reacts following current command of the active channel of the safety drive .
  - With INTERNAL trig, the motor decelerates following **[SS1 commanded deceleration]** [SC30](#).
- At the end of the delay, the motor deceleration is monitored to not exceed a ramp defined by:
  - a deceleration set by **[SS1 monitored deceleration]** [SC31](#).
  - a starting frequency defined by the parameter **[SS1 offset]** [SC32](#) plus the maximum motor frequency reached during **[SS1 delay before monitoring]** [SC34](#).
- If the monitored ramp is violated, the safety function STO is activated and a **[Safety Violation]** [SAVF](#) error is triggered. This error can be reset without power cycle. If **[SS1 violation restriction]** [SC35](#) sets to *Active*, at the 5th SS1 activation with monitored ramp violation, the error triggered can only be reset with a power cycle.
- If the motor frequency reaches **[SS1 standstill level]** [SC33](#), the monitoring of the motor frequency is deactivated and the safety function STO is activated.

The following figure shows the safety function SS1 with [SS1 drive control] SC36 set to Automatic:

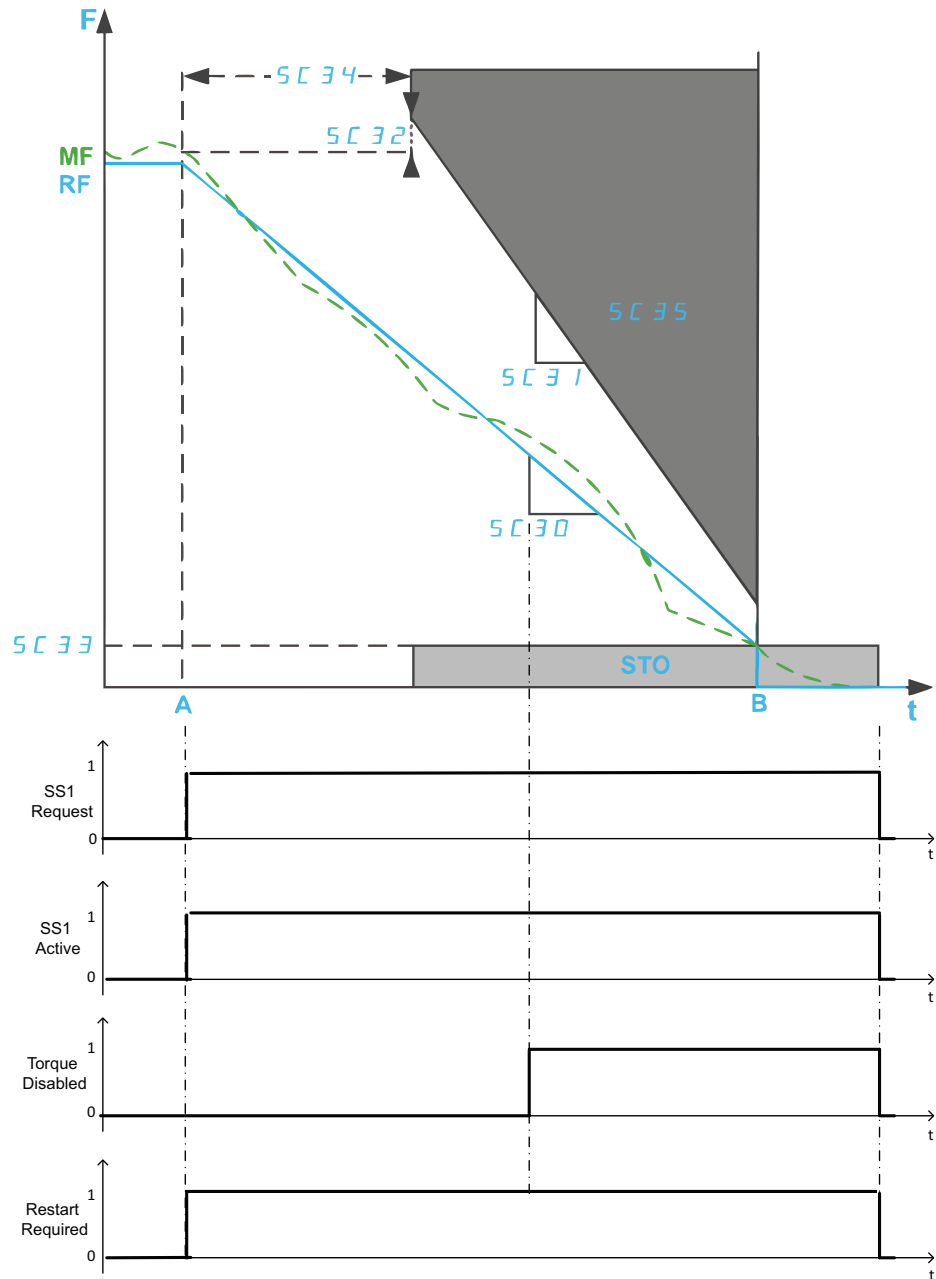

**F:** Frequency / **RF:** Reference Frequency / **MF:** Motor Frequency

**t:** time / **A:** SS1 activation / **B:** STO activation

**SC30:** SS1 commanded deceleration / **SC31:** SS1 monitored deceleration

**SC32:** SS1 Offset / **SC33:** SS1 standstill level

**SC34:** SS1 delay before monitoring / **SC35:** SS1 restricted ramp violation

The following figure shows the safety function SS1 with **[SS1 drive control]** SC36 set to External:

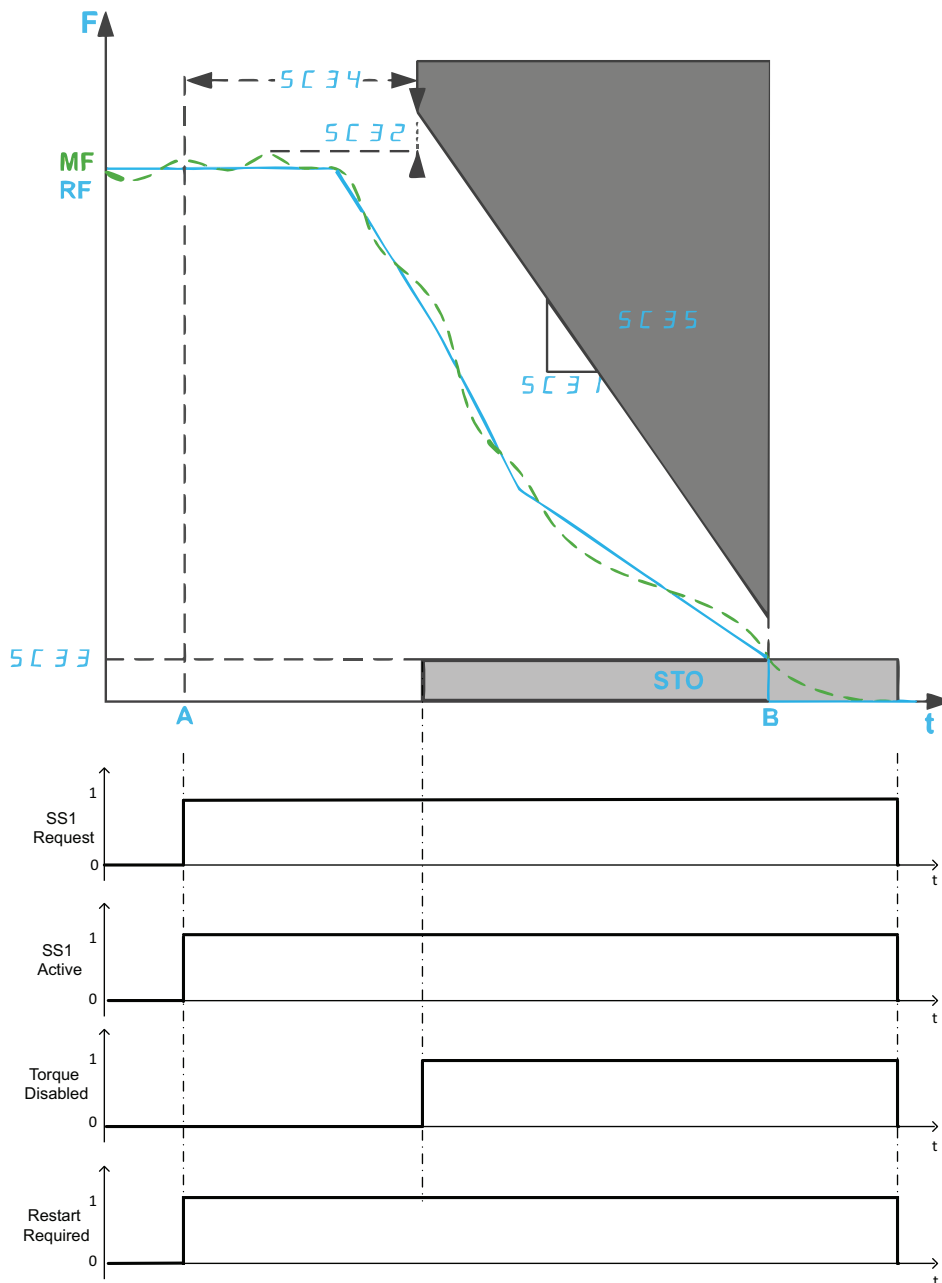

**F:** Frequency / **RF:** Reference Frequency / **MF:** Motor Frequency

**t:** time / **A:** SS1 activation / **B:** STO activation

**SC31:** SS1 monitored deceleration / **SC32:** SS1 Offset / **SC33:** SS1 standstill level

**SC34:** SS1 delay before monitoring / **SC35:** SS1 restricted ramp violation

## Safety function SS1 parameters

**NOTE:** Visibility of SS1 depends on SS1 fieldbus usage is enabled of SLS type 3 or type 6 are configured.

Parameter	Description	Possible values
<b>[SS1 commanded deceleration]</b> SC30	Configure the deceleration command ramp used if the motor frequency is greater than <b>[SS1 standstill level]</b> SC33. <b>NOTE:</b> this parameter can be accessed if <b>[SS1 drive control]</b> SC36 is set to Automatic. It is recommended to configure this parameter to a value equal to or greater than <b>[SS1 monitored deceleration]</b> SC31.	Setting range: • Undefined • 0.1...20,000 Hz/s Step: 0.1 Hz/s
<b>[SS1 monitored deceleration]</b> SC31	Configure the deceleration monitoring ramp used if the motor frequency is greater than <b>[SS1 standstill level]</b> SC33. This parameter must be set to a value different from Undefined.	Setting range: • Undefined • 0.1...20,000 Hz/s Step: 0.1 Hz/s
<b>[SS1 offset]</b> SC32	Configure the added offset value for the monitored ramp. It is recommended to configure this parameter to a value equal to or greater than the maximum motor frequency overshoot plus <b>[Allowed frequency deviation]</b> SC04.	Setting range: 0...200.0 Hz Step: 0.1 Hz
<b>[SS1 standstill level]</b> SC33	Configure the low limit of the motor frequency monitoring and the STO activation level. This parameter must be configured to a value greater than the minimum observable frequency.	Setting range: • Undefined • 0.1...200.0 Hz Step: 0.1 Hz
<b>[SS1 delay before monitoring]</b> SC34	Configure the delay at SS1 activation before to start the ramp monitoring.	Setting range: 0...3,000 ms Step: 1 ms
<b>[SS1 violation restriction]</b> SC35	Configure the type of error triggered on SS1 monitored ramp violation.	
	STO is activated and a <b>[Safety Violation]</b> SAVF error is triggered. This error can be reset without power cycle.	Inactive
	At the 5 <sup>th</sup> SS1 activation with monitored ramp violation, the error triggered can only be reset with a power cycle.	Active
<b>[SS1 drive control]</b> SC36	Configure the source of the ramp deceleration command:	
	Via the ramp down command sent by the active channel of the safety drive	External
	Via the parameter <b>[SS1 commanded deceleration]</b> SC30.	Automatic
<b>[SS1 Fieldbus Usage]</b> SC65	SS1 fieldbus usage.	Setting range: • Safety function not used • Safety function used via fieldbus

# Safety Function SLS (Safely Limited Speed)

## What's in This Chapter

Overview .....	43
Behavior of the Safety Function SLS - Type 1 .....	45
Behavior of the Safety Function SLS - Type 2 .....	46
Behavior of the Safety Function SLS - Type 3 .....	48
Behavior of the Safety Function SLS - Type 4 .....	50
Behavior of the Safety Function SLS - Type 5 .....	51
Behavior of the Safety Function SLS - Type 6 .....	53
Safety function SLS parameters .....	55

## Overview

The safety function SLS prevents the motor from exceeding specified frequency limit. The safety drive limits the motor frequency between the SLS frequency limits.

Depending on the requirements, you can select, for the safety function SLS, one of the 6 types with **[SLS type]** [SC39](#) parameter:

- **SLS type 1:** Limitation of the maximum reference frequency to the motor frequency reached at SLS activation and monitoring of the motor frequency to be within the specified frequency limits.
- **SLS Type 2:** Limitation of the maximum reference frequency to a fixed Set point and monitoring of the motor frequency to be within the specified frequency limits.
- **SLS Type 3:** Same as SLS type 2 with SS1 activation if the motor frequency exceeds the configured threshold value at SLS activation.
- **SLS Type 4:** Limitation of the reference frequency between fixed set points and monitoring of the motor frequency to be within the specified frequency limits. The direction of rotation can be modified while SLS is active.
- **SLS Type 5:** Same as SLS type 4 with a deceleration ramp if the motor frequency exceeds the configured threshold value at SLS activation.
- **SLS Type 6:** Same as SLS type 4 with SS1 activation if the motor frequency exceeds the configured threshold value at SLS activation.

**NOTE:**

- SLS limits the motor in forward (positive) direction and reverse (negative) direction. Only the parameters for the forward direction can be configured, the parameters for the reverse direction are automatically set to the same value.
- The different SLS levels (threshold, set point and standstill level) must be set to values equal or lower than SMS thresholds.
- SLS can be activated via the safety telegram output.

For SLS type 1, type 2 and type 3, in case of an open loop safety configuration, if the power stage is disabled (such as during a freewheel stop), the motor frequency is not monitored by the PROFIsafe module, the SLS function is stopped and STO is applied.

As SLS safety function is not considered as a stop command, if STO is active after SLS triggering, the activation and deactivation of FVo allows the drive to restart.

## **⚠ WARNING**

### **UNANTICIPATED EQUIPMENT OPERATION**

- Verify the restart using FVo does not result in unsafe conditions.
- If restart is not wanted, the PLC program must activate the STO function prior to deactivating FVo.

**Failure to follow these instructions can result in death, serious injury, or equipment damage.**

FVo (Failsafe Value output) can be triggered by:

- PROFIsafe timeout.
- PROFIsafe corruption.
- Activation by the PLC logic

# Behavior of the Safety Function SLS - Type 1

**Limitation of the maximum reference frequency to the motor frequency reached at SLS activation and monitoring of the motor frequency to be within the specified frequency limits.**

At SLS activation, in forward direction:

If the motor frequency is...	Then ...
① above [SLS positive threshold] SC48	[Safety Violation] SAVF error is triggered and STO is activated.
② between [SLS positive threshold] SC48 and [SLS positive standstill level] SC46	The reference frequency is limited to values below the reference frequency value reached at SLS activation.  The motor frequency is monitored. If the value decreases below [SLS positive standstill level] SC46, STO is activated. If the value increases above [SLS positive threshold] SC48, a [Safety Violation] SAVF error is triggered and STO is activated.
③ below [SLS positive standstill level] SC46	STO is activated.

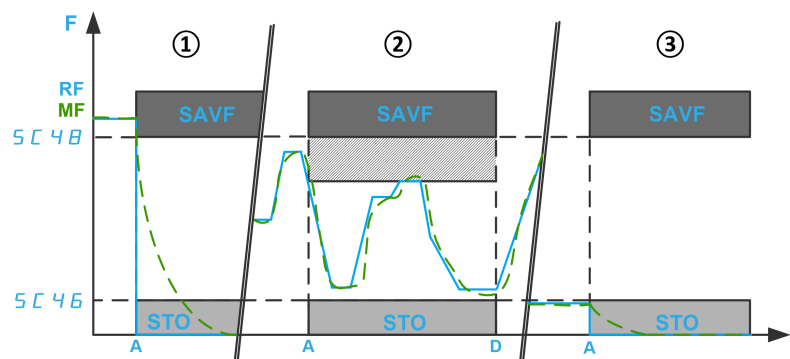

F: Frequency / RF: Reference Frequency / MF: Motor Frequency

A: SLS activation

D: SLS Deactivation

t: time

SC46: SLS Positive Standstill Level / SC48: SLS Positive Threshold

## Behavior of the Safety Function SLS - Type 2

**Limitation of the maximum reference frequency to a fixed set point and monitoring of the motor frequency to be within the specified frequency limits.**

At SLS activation, in forward direction:

If the motor frequency is...	Then ...
① above <b>[SLS positive threshold]</b> SC48	<p>The reference frequency decreases to the configured set point (<b>[SLS positive set point]</b> SC50) according to <b>[Monitored ramp commanded deceleration]</b> SC40.</p> <p>During the deceleration, the motor frequency is monitored according to a ramp defined by:</p> <ul style="list-style-type: none"> <li>• Its ramp: <b>[Monitored ramp deceleration]</b> SC41 (same value as <b>[Monitored ramp commanded deceleration]</b> SC40).</li> <li>• Its starting point: <b>[Monitored ramp offset]</b> SC43 plus the motor frequency value at SLS activation.</li> </ul> <p>If the monitoring ramp is violated, a <b>[Safety Violation]</b> SAVF error is triggered and STO is activated.</p> <p>From the configured threshold value (<b>[SLS positive threshold]</b> SC48), if the motor frequency:</p> <ul style="list-style-type: none"> <li>• Decreases below <b>[SLS positive standstill level]</b> SC46, STO is activated.</li> <li>• Increases above <b>[SLS positive threshold]</b> SC48, a <b>[Safety Violation]</b> SAVF error is triggered and STO is activated.</li> </ul> <p>If the motor frequency reaches the configured set point value (<b>[SLS positive set point]</b> SC50), the reference frequency is limited to values below the configured set point value. The monitoring of the motor frequency remains active.</p>
② between <b>[SLS positive threshold]</b> SC48 and <b>[SLS positive set point]</b> SC50	<p>The reference frequency decreases to the configured set point (<b>[SLS positive set point]</b> SC50) according to <b>[Monitored ramp commanded deceleration]</b> SC40.</p> <p>The motor frequency is monitored. If the value decreases below <b>[SLS positive standstill level]</b> SC46, STO is activated. If the value increases above <b>[SLS positive threshold]</b> SC48, a <b>[Safety Violation]</b> SAVF error is triggered and STO is activated.</p> <p>If the motor frequency reaches the configured set point value (<b>[SLS positive set point]</b> SC50), the reference frequency is limited to values below the configured set point value.</p>
③ between <b>[SLS positive set point]</b> SC50 and <b>[SLS positive standstill level]</b> SC46	<p>The reference frequency is limited to values below the configured set point (<b>[SLS positive set point]</b> SC50).</p> <p>The motor frequency is monitored. If the value decreases below <b>[SLS positive standstill level]</b> SC46, STO is activated. If the value increases above <b>[SLS positive threshold]</b> SC48, a <b>[Safety Violation]</b> SAVF error is triggered and STO is activated.</p>
④ below <b>[SLS positive standstill level]</b> SC46	<p>The delay configured by <b>[SLS wait time]</b> SC54 is started.</p> <p>If the motor frequency reaches the <b>[SLS positive standstill level]</b> SC46 before the end of the temporization, then</p> <ul style="list-style-type: none"> <li>• the reference frequency is limited to values below <b>[SLS positive set point]</b> SC50,</li> <li>• the motor frequency is monitored. If the value decreases below <b>[SLS positive standstill level]</b> SC46, STO is activated. If the value increases above <b>[SLS positive threshold]</b> SC48, a <b>[Safety Violation]</b> SAVF error is triggered and STO is activated.</li> </ul> <p>else STO is activated without error triggered.</p>

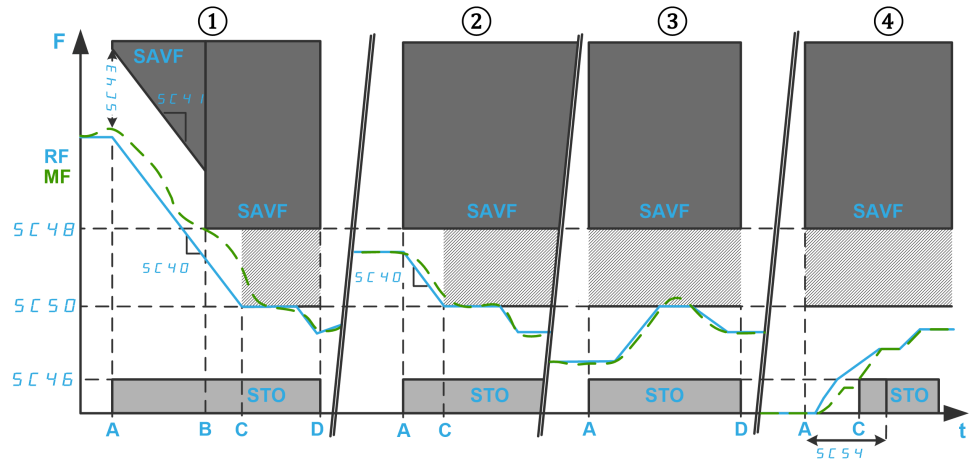

**F:** Frequency / **RF:** Reference Frequency / **MF:** Motor Frequency

**t:** time

**SC46:** SLS Positive Standstill Level / **SC48:** SLS Positive Threshold / **SC50:** SLS Positive Set Point

**SC54:** SLS Wait Time

**SC40:** Monitored ramp commanded deceleration / **SC41:** Monitored ramp deceleration / **SC43:** Monitored ramp offset

**A:** SLS activation

**B:** Threshold reached

**C:** Set Point or Standstill level reached

**D:** SLS Deactivation

# Behavior of the Safety Function SLS - Type 3

Same as SLS type 2 with SS1 activation if the motor frequency exceeds the configured threshold value at SLS activation.

**NOTE:** after SS1, the power stage is locked. If the source of SS1 activation has been deactivated before its completion, the PROFIsafe module completes SS1 but remains in STO for only a short time (100ms), then automatically removes the STO.

At SLS activation, in forward direction:

If the motor frequency is...	Then ...
① above [SLS positive threshold] SC48	SS1 <sup>(1)</sup> is activated.
② between [SLS positive threshold] SC48 and [SLS positive set point] SC50	The reference frequency decreases to the configured set point ([SLS positive set point] SC50) according to [Monitored ramp commanded deceleration] SC40.  The motor frequency is monitored. If the value decreases below [SLS positive standstill level] SC46, STO is activated. If the value increases above [SLS positive threshold] SC48, a [Safety Violation] SAVF error is triggered and STO is activated.  If the motor frequency reaches the configured set point value ([SLS positive set point] SC50), the reference frequency is limited to values below the configured set point value.
③ between [SLS positive set point] SC50 and [SLS positive standstill level] SC46	The reference frequency is limited to values below the configured set point ([SLS positive set point] SC50).  The motor frequency is monitored. If the value decreases below [SLS positive standstill level] SC46, STO is activated. If the value increases above [SLS positive threshold] SC48, a [Safety Violation] SAVF error is triggered and STO is activated.
④ below [SLS positive standstill level] SC46	The delay configured by [SLS wait time] SC54 is started.  If the motor frequency reaches the [SLS positive standstill level] SC46 before the end of the temporization, then <ul style="list-style-type: none"> <li>the reference frequency is limited to values below [SLS positive set point] SC50,</li> <li>the motor frequency is monitored. If the value decreases below [SLS positive standstill level] SC46, STO is activated. If the value increases above [SLS positive threshold] SC48, a [Safety Violation] SAVF error is triggered and STO is activated.</li> </ul> else STO is activated without error triggered.

(1): With SLS type 3, SS1 must be configured in Automatic mode.

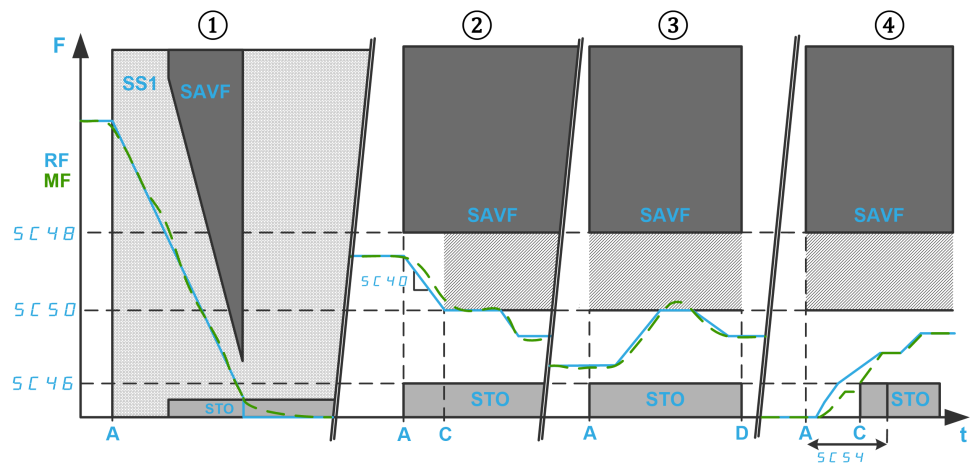

F: Frequency / RF: Reference Frequency / MF: Motor Frequency

t: Time

SC40: Monitored ramp commanded deceleration

SC46: SLS Positive Standstill Level / SC48: SLS Positive Threshold / SC50: SLS Positive Set Point

SC54: SLS Wait Time

A: SLS activation

**B:** Set Point or Standstill level reached

**D:** SLS Deactivation

# Behavior of the Safety Function SLS - Type 4

**Limitation of the reference frequency between fixed set points and monitoring of the motor frequency to be within the specified frequency limits. The direction of rotation can be changed while the SLS is active.**

At SLS activation, in forward direction:

If the motor frequency is...	Then ...
① above [SLS positive threshold] SC48	[Safety Violation] SAVF error is triggered and STO is activated.
② between [SLS positive threshold] SC48 and [SLS positive set point] SC50	<p>The reference frequency decreases to the configured set point ([SLS positive set point] SC50) according to [Monitored ramp commanded deceleration] SC40.</p> <p>The motor frequency is monitored. If the value exceeds [SLS positive threshold] SC48 or [SLS negative threshold] SC49, a [Safety Violation] SAVF error is triggered and STO is activated.</p> <p>If the motor frequency reaches the configured set point value ([SLS positive set point] SC50), the reference frequency is limited to values between the set point values. The monitoring of the motor frequency remains active.</p>
③ below [SLS positive set point] SC50	<p>The reference frequency is limited to values between the set point values ([SLS positive set point] SC50 and [SLS negative set point] SC51).</p> <p>The motor frequency is monitored. If the value exceeds [SLS positive threshold] SC48 or [SLS negative threshold] SC49, a [Safety Violation] SAVF error is triggered and STO is activated.</p>

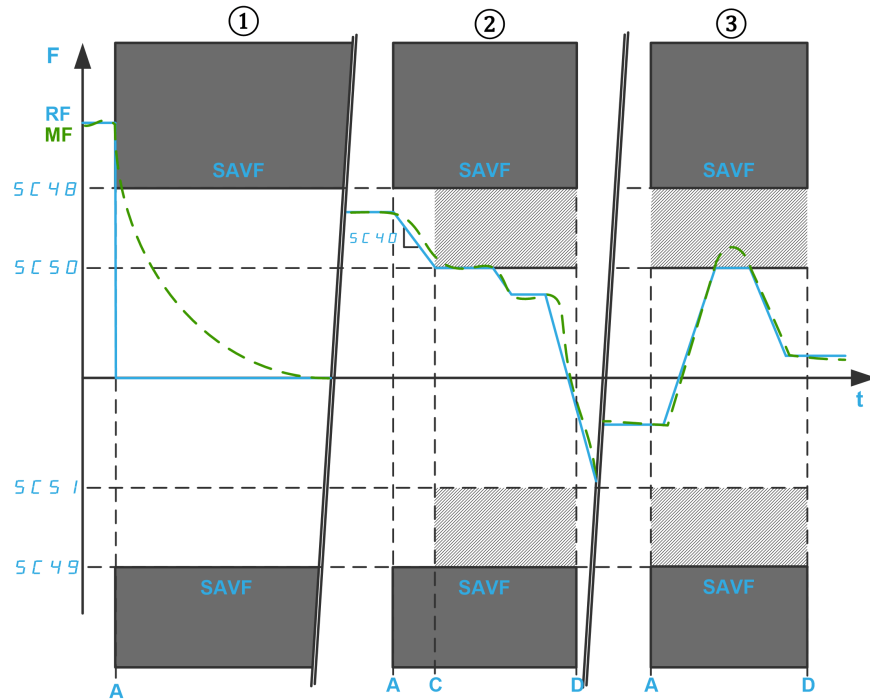

F: Frequency / RF: Reference Frequency / MF: Motor Frequency

t: time

SC40: Monitored ramp commanded deceleration

SC48: SLS Positive Threshold / SC49: SLS Negative Threshold

SC50: SLS Positive Set Point / SC51: SLS Negative Set Point

A: SLS activation

C: Set Point reached

D: SLS Deactivation

## Behavior of the Safety Function SLS - Type 5

Same as SLS type 4 with a deceleration ramp if the motor frequency exceeds the configured threshold value at SLS activation.

At SLS activation, in forward direction:

If the motor frequency is...	Then ...
① above <b>[SLS positive threshold]</b> SC48	<p>The reference frequency decreases to the configured set point (<b>[SLS positive set point]</b> SC50) according to <b>[Monitored ramp commanded deceleration]</b> SC40.</p> <p>During the deceleration, the motor frequency is monitored according to a ramp defined by:</p> <ul style="list-style-type: none"> <li>• Its ramp: <b>[Monitored ramp deceleration]</b> SC41 (same value as <b>[Monitored ramp commanded deceleration]</b> SC40).</li> <li>• Its starting point: <b>[Monitored ramp offset]</b> SC43 plus the motor frequency value at SLS activation.</li> </ul> <p>If the monitoring ramp is violated, a <b>[Safety Violation]</b> SAVF error is triggered and STO is activated.</p> <p>If the motor frequency reaches the configured threshold value (<b>[SLS positive threshold]</b> SC48), the motor frequency is monitored. If the value exceeds <b>[SLS positive threshold]</b> SC48 or <b>[SLS positive set point]</b> SC50, a <b>[Safety Violation]</b> SAVF error is triggered and STO is activated.</p> <p>If the motor frequency reaches the configured set point value (<b>[SLS positive set point]</b> SC50), the motor frequency remains monitored and the reference frequency is limited to values between the set point values (<b>[SLS positive set point]</b> SC50 and <b>[SLS negative set point]</b> SC51).</p>
② between <b>[SLS positive threshold]</b> SC48 and <b>[SLS positive set point]</b> SC50	<p>The reference frequency decreases to the configured set point (<b>[SLS positive set point]</b> SC50) according to <b>[Monitored ramp commanded deceleration]</b> SC40.</p> <p>The motor frequency is monitored. If the value exceeds <b>[SLS positive threshold]</b> SC48 or <b>[SLS positive set point]</b> SC50, a <b>[Safety Violation]</b> SAVF error is triggered and STO is activated.</p> <p>If the motor frequency reaches the configured set point value (<b>[SLS positive set point]</b> SC50), the reference frequency is limited to values between the set point values. The monitoring of the motor frequency remains active.</p>
③ below <b>[SLS positive set point]</b> SC50	<p>The reference frequency is limited to values between the set point values (<b>[SLS positive set point]</b> SC50 and <b>[SLS negative set point]</b> SC51).</p> <p>The motor frequency is monitored. If the value exceeds <b>[SLS positive threshold]</b> SC48 or <b>[SLS positive set point]</b> SC50, a <b>[Safety Violation]</b> SAVF error is triggered and STO is activated.</p>

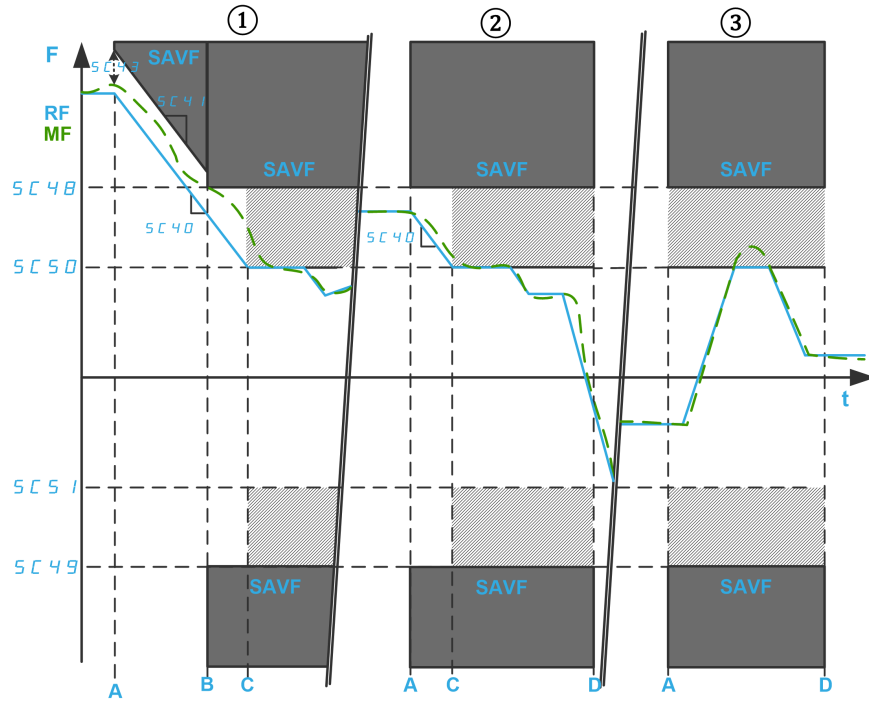

**F:** Frequency / **RF:** Reference Frequency / **MF:** Motor Frequency

**t:** time

**SC48:** SLS Positive Threshold / **SC49:** SLS Negative Threshold

**SC50:** SLS Positive Set Point / **SC51:** SLS Negative Set Point

**SC40:** Monitored ramp commanded deceleration

**SC41:** Monitored ramp deceleration / **SC43:** Monitored ramp offset

**A:** SLS activation

**B:** Threshold reached

**C:** Set Point reached

**D:** SLS Deactivation

# Behavior of the Safety Function SLS - Type 6

Same as SLS type 4 with SS1 activation if the motor frequency exceeds the configured threshold value at SLS activation.

**NOTE:** after SS1, the power stage is locked. If the source of SS1 activation has been deactivated before its completion, the PROFIsafe module completes SS1 but remains in STO for only a short time(100ms), then automatically removes the STO.

At SLS activation, in forward direction:

If the motor frequency is...	Then ...
① above [SLS positive threshold] SC48	SS1 <sup>(1)</sup> is activated.
② between [SLS positive threshold] SC48 and [SLS positive set point] SC50	<p>The reference frequency decreases to the configured set point ([SLS positive set point] SC50) according to [Monitored ramp commanded deceleration] SC40.</p> <p>The motor frequency is monitored. If the value exceeds [SLS positive threshold] SC48 or [SLS negative threshold] SC49, a [Safety Violation] SAVF error is triggered and STO is activated.</p> <p>If the motor frequency reaches the configured set point value ([SLS positive set point] SC50), the reference frequency is limited to values between the set point values. The monitoring of the motor frequency remains active.</p>
③ below [SLS positive set point] SC50	<p>The reference frequency is limited to values between the set point values ([SLS positive set point] SC50 and [SLS negative set point] SC51).</p> <p>The motor frequency is monitored. If the value exceeds [SLS positive threshold] SC48 or [SLS negative threshold] SC49, a [Safety Violation] SAVF error is triggered and STO is activated.</p>

(1): With SLS type 6, SS1 must be configured in Automatic mode.

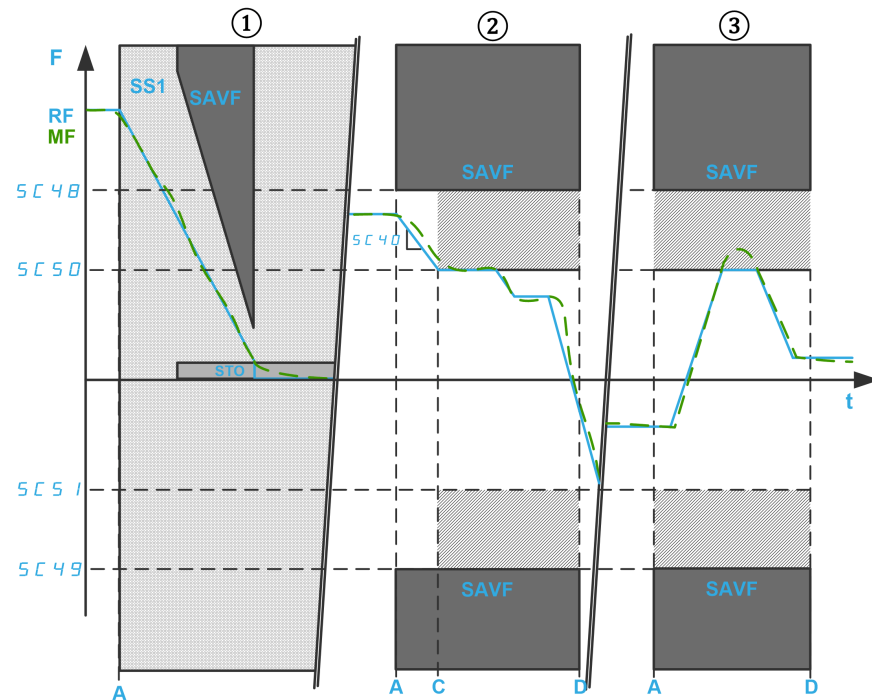

F: Frequency / RF: Reference Frequency / MF: Motor Frequency

t: time

SC40: Monitored ramp commanded deceleration

SC48: SLS Positive Threshold / SC49: SLS Negative Threshold

SC50: SLS Positive Set Point / SC51: SLS Negative Set Point





A: SLS activation

C: Set Point reached

**D: SLS Deactivation**

# Safety function SLS parameters

The following table gives the list of parameters for the safety function SLS:

Parameter	Description	Possible values
<b>[SLS type]</b> SC39	The type of the safety function SLS. See the overview for SLS types information. If SLS fieldbus usage is enabled.	Setting range: <ul style="list-style-type: none"> <li>Undefined</li> <li>SLS Type 1</li> <li>SLS Type 2</li> <li>SLS Type 3 <sup>(1)</sup></li> <li>SLS Type 4</li> <li>SLS Type 5</li> <li>SLS Type 6 <sup>(1)</sup></li> </ul>
<b>[Monitored ramp commanded deceleration]</b> SC40	Deceleration command ramp used when the motor frequency is greater than <b>[SLS positive set point]</b> SC50 or less than <b>[SLS negative set point]</b> SC51.	Setting range: <ul style="list-style-type: none"> <li>Undefined</li> <li>0.1...20,000 Hz/s</li> </ul> Step: 0.1 Hz/s
<b>[Monitored ramp deceleration]</b> SC41 	Deceleration monitoring ramp used when the motor frequency is greater than <b>[SLS positive threshold]</b> SC48 or less than <b>[SLS negative threshold]</b> SC49 at SLS activation.  Only used with SLS type 2 and SLS type 5.  Defined with <b>[Monitored ramp commanded deceleration]</b> SC40.	Setting range: <ul style="list-style-type: none"> <li>Undefined</li> <li>0.1...20,000 Hz/s</li> </ul> Step: 0.1 Hz/s
<b>[Monitored ramp offset]</b> SC43	Added offset value for the monitored ramp.	Setting range: 0...200.0 Hz Step: 0.1 Hz
<b>[SLS positive standstill level]</b> SC46 <sup>(2)</sup>	STO activation level in forward direction.	Setting range: <ul style="list-style-type: none"> <li>Inactive</li> <li>0.1...200.0 Hz</li> </ul> Step: 0.1 Hz
<b>[SLS negative standstill level]</b> SC47 	STO activation level in reverse direction.  Configured via <b>[SLS positive standstill level]</b> SC46.	Setting range: <ul style="list-style-type: none"> <li>Inactive</li> <li>0.1...200.0 Hz</li> </ul> Step: 0.1 Hz
<b>[SLS positive threshold]</b> SC48 <sup>(2)</sup>	High limit of the motor frequency monitoring in forward direction.	Setting range: 0...200.0 Hz Step: 0.1 Hz
<b>[SLS negative threshold]</b> SC49  <sup>(2)</sup>	High limit of the motor frequency monitoring in reverse direction.  Configured via <b>[SLS positive threshold]</b> SC48.	Setting range: 0...200.0 Hz Step: 0.1 Hz
<b>[SLS positive set point]</b> SC50 <sup>(2)</sup>	Maximum reference frequency in forward direction.	Setting range: 0...200.0 Hz Step: 0.1 Hz
<b>[SLS negative set point]</b> SC51  <sup>(2)</sup>	Maximum reference frequency in reverse direction.  Configured via <b>[SLS positive set point]</b> SC50.	Setting range: 0...200.0 Hz Step: 0.1 Hz
<b>[SLS wait time]</b> SC54	Delay at SLS activation within the motor frequency can remain inside the standstill level.	Setting range: <ul style="list-style-type: none"> <li>Inactive</li> <li>0...65,535ms</li> </ul> Step: 1 ms
<b>[SLS Fieldbus Usage]</b> SC66	Fieldbus usage.	<ul style="list-style-type: none"> <li>Safety function not used</li> <li>Safety function used via fieldbus</li> </ul>

(1): This setting requires to configure the safety function SS1 in automatic mode.

(2): This parameter must be configured to a value greater than the minimum observable frequency.

The following table gives the list of parameters used for each type of the safety function SLS:

[SLS type] SC39	SLS Type 1	SLS Type 2	SLS Type 3 (2)	SLS Type 4	SLS Type 5	SLS Type 6 (2)
[Monitored ramp commanded deceleration] SC40	-	To be configured				
[Monitored ramp deceleration] SC41	-	Equal to SC40 (1)	-	-	Equal to SC40 (1)	-
[Monitored ramp offset] SC43	-	Recommendation: Equal to or greater than the maximum motor frequency overshoot plus SC04.	-	-	Recommendation: Equal to or greater than the maximum motor frequency overshoot plus SC04.	-
[SLS positive standstill level] SC46	To be configured to a value equal to or less than SC48	To be configured to a value equal to or less than SC50		-		
[SLS negative standstill level] SC47	Equal to SC46 (1)			-		
[SLS positive threshold] SC48	To be configured to a value equal to or greater than SC46	To be configured to a value equal to or greater than SC50.				
[SLS negative threshold] SC49	Equal to SC48 (1)					
[SLS positive set point] SC50	-	To be configured between SC46 and SC48 (included)		To be configured to a value equal to or less than SC48.		
[SLS negative set point] SC51	-	Equal to SC50 (1)				
[SLS wait time] SC54	-	To be configured		-		
[SLS Fieldbus Usage] SC66	To be configured					
(1): Fixed setting value. (2): This setting requires to configure the safety function SS1 in automatic mode. (3): If SMS is configured, SLS thresholds must be set to values equal or lower than SMS thresholds.						

# Safety Function SMS (Safe Maximum Speed)

## Overview

The safety function SMS prevents the motor frequency from exceeding the specified safe maximum frequency limits.

Depending on the requirements, you can select, for the safety function SMS, one of the 3 modes with **[SMS function mode]** `sc56` parameter:

- `1 threshold`: One safe maximum frequency limit for each direction.
- `2 thresholds`: Two safe maximum frequency limits for each direction. A safety output telegram is used to switch from one safe maximum frequency limit to the other.
- `Maintenance`: One safe maximum frequency limit for each direction activated via the PROFIsafe telegram.

**Note:**

- The SMS function does not adjust the frequency reference value.  
The frequency reference value should be adjusted via the active reference channel in order to remain within the boundaries defined by the safe maximum frequency limits.
- The lowest SMS thresholds must be set in order to include the different SLS levels (threshold, set point and standstill level).

In case of an open loop safety configuration, if the power stage is disabled (such as during a freewheel stop), the motor frequency is not monitored by the PROFIsafe module, the SMS function is stopped and STO is applied by the safety module.

# Behavior of The Safety Function SMS with 1 threshold

**One safe maximum frequency limit for each direction.**

The safety function SMS is active when the safety module switches in the operating state *Operation Enabled*. While the function is active, if the motor frequency exceeds one of the specified safe maximum frequency limits (parameters **[SMS positive threshold 1]** SC57 or **[SMS negative threshold 1]** SC58) a STO is triggered and an error **[Safety Violation]** SAVF is raised.

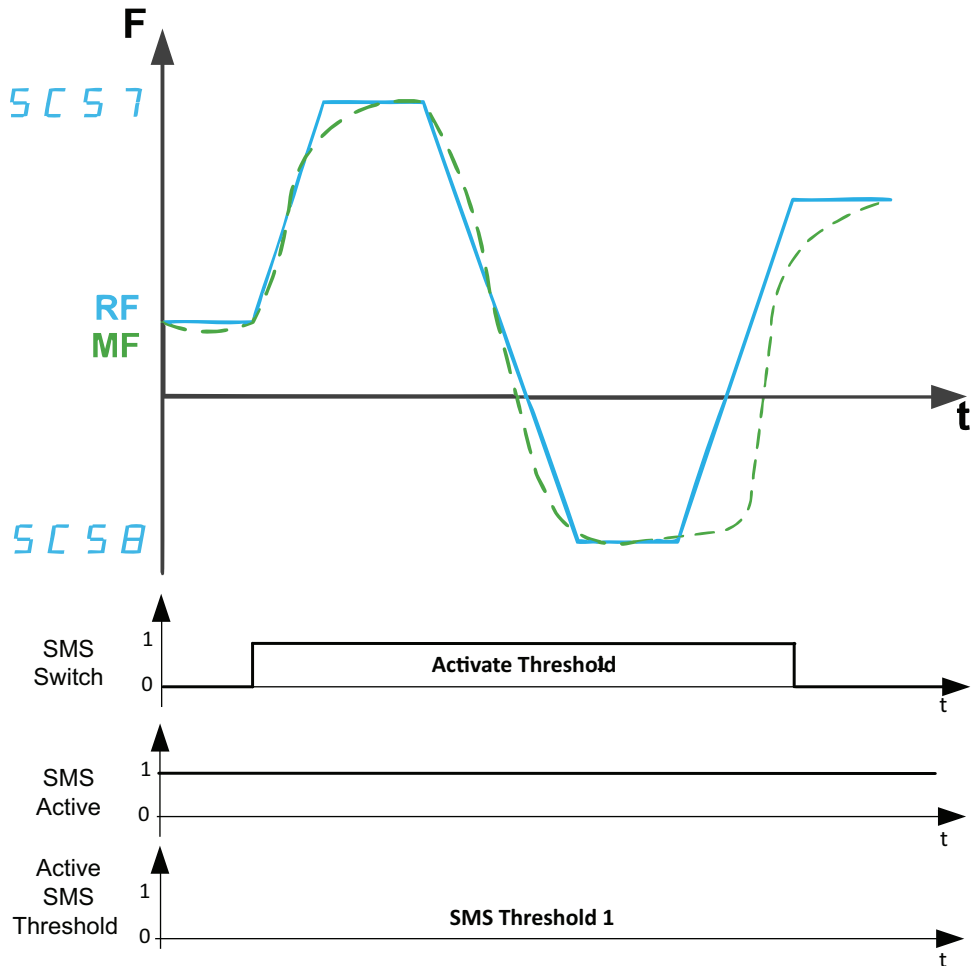

**F:** Frequency / **RF:** Reference Frequency

**MF:** Motor Frequency / **t:** time

**SC57:** SMS positive threshold 1

**SC58:** SMS negative threshold 1

# Behavior of The Safety Function SMS with 2 thresholds

**Two safe maximum frequency limits for each direction. A safety-related input is used to switch from one safe maximum frequency limit to the other.**

The safety function SMS is active when the safety module switches in the operating state *Operation Enabled*. While the function is active:

- If Bit of PROFIsafe telegram related to SMS request is set to 0 and the motor frequency exceeds one of the specified safe maximum frequency limits (parameters **[SMS positive threshold 1] SC57** or **[SMS negative threshold 1] SC58**) then a STO is triggered and an error **[Safety Violation] SAVF** is raised.
- If Bit of PROFIsafe telegram related to SMS request is set to 1 and the motor frequency exceeds one of the specified safe maximum frequency limits (parameters **[SMS positive threshold 2] SC59** or **[SMS negative threshold 2] SC60**) then a STO is triggered and an error **[Safety Violation] SAVF** is raised.

**[SMS positive threshold 2] SC59** must be equal to or less than **[SMS positive threshold 1] SC57** and **[SMS negative threshold 2] SC60** must be equal to or less than **[SMS negative threshold 1] SC58**.

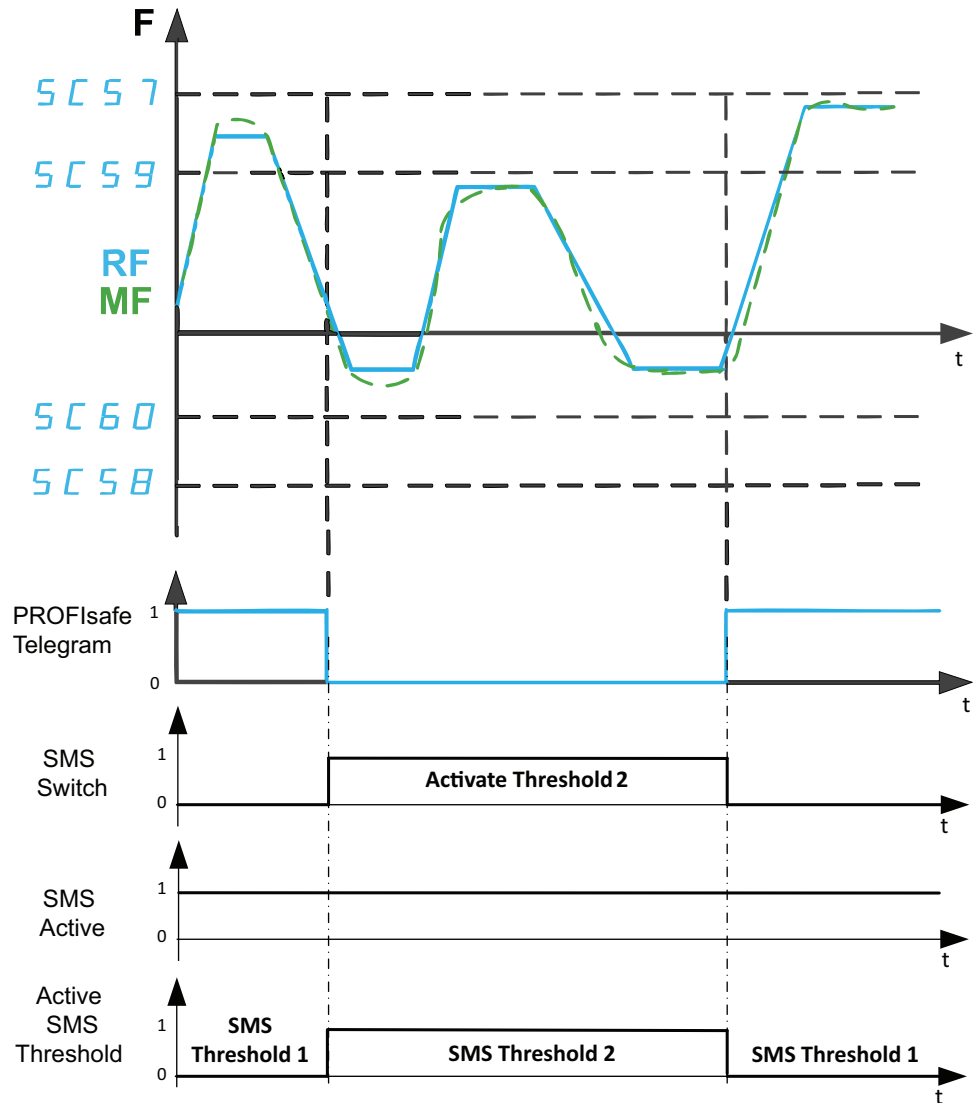

**F:** Frequency / **RF:** Reference Frequency

**MF:** Motor Frequency / **t:** time

**SC57:** SMS positive threshold 1 / **SC58:** SMS negative threshold 1

**SC59:** SMS positive threshold 2 / **SC60:** SMS negative threshold 2

## Behavior of the safety function SMS maintenance

**One safe maximum frequency limit activated via Bit related to SMS request on PROFIsafe telegram.**

The safety function SMS can be activated when the safety module switches in the operating state `Operation Enabled`:

- If SMS request of PROFIsafe telegram is set to 0, the safety function SMS is deactivated: the motor frequency is not monitored.
- If Bit related to SMS request of PROFIsafe telegram is set to 1 and the motor frequency exceeds one of the specified safe maximum frequency limits (parameters **[SMS positive threshold 1]** `SC57` or **[SMS negative threshold 1]** `SC58`) then a STO is triggered and an error **[Safety Violation]** `SAVF` is raised.

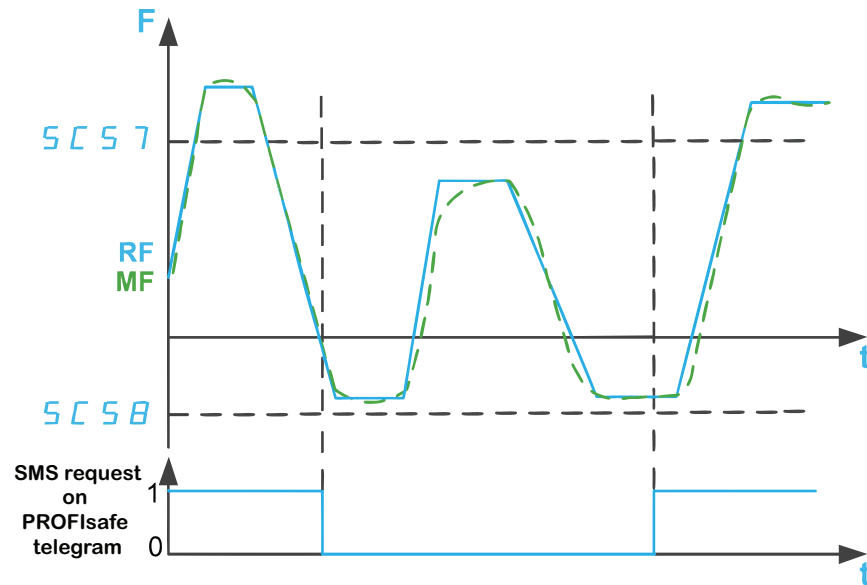

**F:** Frequency / **RF:** Reference Frequency

**MF:** Motor Frequency / **t:** time

**SC57:** SMS positive threshold 1 / **SC58:** SMS negative threshold 1

# Safety Function SMS Parameters

The following table gives the list of parameters for the safety function SMS:

Parameter	Description	Possible values
<b>[SMS function mode]</b> SC56	Allows you to select the mode of the safety function SMS.	
	Function not used.	Function inactive
	One safe maximum frequency limit for each direction.	1 threshold
	Two safe maximum frequency limits for each direction.	2 thresholds
	One safe maximum frequency limit activated via a Bit of PROFIsafe telegram	Maintenance
<b>[SMS positive threshold 1]</b> SC57 <sup>(1)</sup>	Configure the safe maximum frequency limit 1 in positive direction.	Setting range: 0...200.0 Hz Step: 0.1 Hz
<b>[SMS negative threshold 1]</b> SC58 <sup>(1)</sup>	Configure the safe maximum frequency limit 1 in negative direction. <b>NOTE:</b> The frequency limit considered is the negative value.	Setting range: 0...200.0 Hz Step: 0.1 Hz
<b>[SMS positive threshold 2]</b> SC59 <sup>(1)</sup>	Configure the safe maximum frequency limit 2 in positive direction. <b>[SMS positive threshold 2]</b> SC59 must be equal to or less than <b>[SMS positive threshold 1]</b> SC57.	Setting range: 0...200.0 Hz Step: 0.1 Hz
<b>[SMS negative threshold 2]</b> SC60 <sup>(1)</sup>	Configure the safe maximum frequency limit 2 in negative direction. <b>NOTE:</b> The frequency limit considered is the negative value. <b>[SMS negative threshold 2]</b> SC60 must be equal to or less than <b>[SMS negative threshold 1]</b> SC58.	Setting range: 0...200.0 Hz Step: 0.1 Hz
(1): This parameter must be configured to a value greater than the minimum observable frequency.		

The following table gives the list of parameters used for each mode of the safety function SMS:

<b>[SMS function mode]</b> SC56	1 threshold	2 thresholds	Maintenance
<b>[SMS positive threshold 1]</b> SC57 <sup>(1)</sup>	To be configured		
<b>[SMS negative threshold 1]</b> SC58 <sup>(1)</sup>	To be configured		
<b>[SMS positive threshold 2]</b> SC59 <sup>(1)</sup>	-	To be configured to a value equal to or less than SC57	-
<b>[SMS negative threshold 2]</b> SC60 <sup>(1)</sup>	-	To be configured to a value equal to or less than SC58	-
(1): If SLS is configured, SLS thresholds must be set within the lowest SMS thresholds			

# Compatibility and Precedence of Safety Functions and Non-Safety-Related Functions

## Type of Motor

Type of Motor	Open/Closed Loop safety configuration <sup>(1)</sup>	Safety Functions			
		SS1	SLS	SMS	STO <sup>(3)</sup>
Asynchronous	Open loop	✓	✓	✓	✓
	Closed loop	✓	✓	✓	✓
Synchronous <sup>(2)</sup>	Open loop	-	-	-	✓
	Closed loop	✓	✓	✓	✓
Reluctant	Open loop	-	-	-	✓
	Closed loop	-	-	-	✓

(1): for the possible [Motor Control Type] CTT settings, refer to the Compatibility Table, page 64.  
 (2): permanent magnets synchronous motors. Reluctance motors are not covered by the safety module.  
 (3): for all type of motors.

## Prerequisites for Using Safety Functions

### ⚠ WARNING

#### LOSS OF SAFETY FUNCTION

Incorrect usage may cause a hazard due to the loss of the safety function.

- Observe the requirements for using the safety function.

**Failure to follow these instructions can result in death, serious injury, or equipment damage.**

Following conditions have to be fulfilled for correct operation with the safety module:

- The maximum output frequency is equal to or less than 200 Hz,
- The motor size is adequate for the application and is not at the limit of its capacity.
- The application inertia is adequate for the safety module.

Example: A controlled stop (with SS1) or a deceleration ramp with SLS cannot be done in a time longer than 8 min 20 s if the deceleration starts from 50 Hz and ends to 0 Hz. The minimum of the deceleration ramp and the deceleration monitoring is 0.1 Hz/s.

- The safety drive has been correctly chosen for the line supply, sequence, motor, and application and is not at the limit of their capacities as stated in the catalog
- If required, the appropriate options are used.

Example: dynamic braking resistor or motor choke. Encoder Module for closed loop control.

- The safety drive is correctly set up with the correct speed loop and torque characteristics for the application; the reference frequency profile applied to the safety drive control loop is followed.

- During a category 0 stop (as per IEC 60204), the motor coasts down in an uncontrolled way. If access to the machine coasting down involves a hazard (results of the hazard and risk analysis), you must take appropriate measures.
- A controlled stop must be triggered with a category 1 stop (as per IEC 60204). The controlled stop is not monitored by the safety drive system. In the case of power outage or an error, a controlled stop is impossible.
- Tests of IGBTs at power on of the safety drive cannot be fulfilled with safety module inserted in the safety drive. This is also the case for tests of IGBTs done via **[IGBT Diag w/o motor] IWOT** and **[IGBT Diag w motor] IWT**.

## Allowed and Unallowed Application for Safety Function

Applications with acceleration of the load are not allowed (for example, applications with active or pull-through load on the motor shaft, long/permanent regenerative braking cycles).

Examples: Vertical Conveyors, Vertical hoist, Lifts, or Winders.

## Disable Error Detection

The errors linked to the safety module (**SIOF**, **SAVF**, **SCFF** and **INFI**) cannot be inhibited by the function **[Error Detection Disable] INH-**.

## Electrical Frequency and Mechanical Frequency

Two motor frequencies can be defined:

- The electrical frequency corresponding to the stator frequency of the motor,
- The mechanical frequency corresponding to the rotor frequency of the motor.

The motor frequency is monitored in each of the 2 channels of the safety module. To help prevent frequency deviation (or inconsistency), the safety module cross compares these 2 motor frequencies:

- In open loop control, two electrical frequencies are compared.
- In closed loop control, an electrical frequency is compared with the mechanical frequency.

The threshold of frequency deviation is defined via the parameter **[Allowed frequency deviation] SC04**. The threshold must consider several factors such as application inertia, stress of the motor (acceleration/deceleration), slip of the motor in order to have a correct compromise between robustness and reliability.

In case of frequency deviation, **[Motor Freq Deviation] SME02C** error code is triggered.

# Compatibility Table

## ⚠ WARNING

### UNANTICIPATED EQUIPMENT OPERATION

Verify that you do not use those application functions and safety functions concurrently that are designated as incompatible in the following table.

**Failure to follow these instructions can result in death, serious injury, or equipment damage.**

Table 1

	SAFETY MODULE USER FUNCTIONS				
	STO	SS1	SLS ramp	SLS steady	SMS
[High speed hoisting] <i>HSH</i> (1)	▲	x	x	x	x
[ENA System] <i>ENA</i>	o	o	o	o	o
[+/- speed] <i>UPD</i>	▲	▲	▲	▲	o
[Jump frequency] <i>JUF</i> (2)	▲	▲	▲	◀	o
[Stop after speed timeout] <i>PRSP</i>	▲	x	x	x	x
[Multimotors config] <i>MMC</i> (3)	o	o	o	o	o
[Preset speeds] <i>PSS</i>	▲	▲	▲	▲	o
[PID controller] <i>PID</i>	▲	▲	x	x	o
[Ramp] <i>RAMP</i>	▲	▲	▲	x	o
[Ramp switching] <i>RPT</i>	▲	▲	▲	o	o
[Freewheel Stop] <i>NST</i> (4)	o	•	•	• <i>NST before SLS</i> (see note)	• <i>NST before SMS</i> (see note)
[Fast Stop Assign] <i>FSE</i>	▲	▲	▲	o	o

(1): STO: reference safety message about vertical axes, external mechanical protections shall be installed.

(2): In SLS steady: if setpoint is positioned on forbidden speed interval, skip frequency setpoint is applied instead of real setpoint configured. However SLS function continues to monitor speed and reacts if necessary.

(3): Check that different configuration are consistent with safety module configuration (motor specification, frequency threshold,...).

(4): NST with SS1: STO activated (due to low limit level).

- In open loop:
  - NST activated before SLS type 1/2/3: STO is activated (due to low limit level).
  - NST activated before SLS type 4/5/6 and SMS: STO not activated. Consider freewheel stop from maximum frequency.
- In Closed loop, NST activated before SLS/SMS: safety error triggered

**Legend:**

- **O**: Compatible functions
- **▲◀**: The function to which the arrow points takes precedence over the other function.
- **•**: Safe state

Table 2

	SAFETY MODULE USER FUNCTIONS				
	STO	SS1	SLS ramp	SLS steady	SMS
[Ext Error assign] <i>ETF</i> (1)	o NST	• NST	• NST	• NST before SLS (see note)	• NST before SMS (see note).
	▲ DCI	x DCI	x DCI	x DCI	x DCI
	LFF RLS RMP FST	▲ LFF RLS RMP FST	▲ LFF RLS RMP FST	o: • NST during SLS • RMP • FST  ▲ LFF RLS	o: NST during SMS
[Auto Fault Reset] <i>ATR</i> (2)	▲	▲	o	o	o
[Fault reset] <i>RST</i>	o	o	o	o	o
[Jog] <i>JOG</i>	▲	▲	▲	▲	o
[Stop configuration] <i>STT</i> (1)	o NST	• NST	• NST	• NST before SLS (see note)	• NST before SMS (see note)
	▲ DCI	x DCI	x DCI	x DCI	x DCI
	RMP FST	▲ RMP FST	▲ RMP FST	o • NST during SLS • RMP • FST	o NST during SMS  <b>Other cases</b>
[+/- speed around ref] <i>SRE</i>	▲	▲	▲	▲	o
[Positioning by sensors] <i>LPO</i>	▲	x	x	x	x
[Prod Restart Assign] <i>RPA</i> (3)	o	o	o	o	o
[Process underload] <i>ULD</i>	o	o	o	o	o

(1): See note of NST.

(2): When module safety is in STO state, Automatic restart is disabled. In 2 wires level, door locking should be associated to a system which checks that nobody is present on forbidden area before motor restarts.

(3): When safety module is not supplied, it goes on STO state and SQ1 = 0. When supply is restored, safety module state depends on SM start input setting.

**Legend:**

- **O**: Compatible functions
- **▲◀**: The function to which the arrow points takes precedence over the other function.
- **•**: Safe state
- **NST**: [Freewheel Stop]
- **DCI**: [DC injection]
- **LFF**: [Fallback speed]
- **RLS**: [Spd Maint Behavior]
- **RMP**: [Ramp Stop]
- **FST**: [Fast Stop Assign]

Table 3

	SAFETY MODULE USER FUNCTIONS				
	STO	SS1	SLS ramp	SLS steady	SMS
[Process overload] <small>OLD</small>	o	o	o	o	o
[Rope Slack Handling] <small>SDR</small> <sup>(1)</sup>	▲	x	x	x	x
[Dynamic load detect.] <small>DLD</small> <sup>(1)</sup>	▲	x	x	x	x
[Undervoltage handling] <small>USB</small>	o	o	o	o	o
[Load Sharing] <small>LDS</small>	▲	◀	◀	◀	o
<b>[Motor control type] <small>CTT</small></b>					
[U/F VC Standard] <small>STD</small>	o	x	x	x	x
[SVC V] <small>VVC</small>	o	o	o	o	o
[FVC] <small>FVC</small>	o	o	o	o	o
[Sync. mot.] <small>SYN</small>	o	x	x	x	x
[Energy Sav.] <small>NLD</small>	o	o	o	o	o
[Sync.CL] <small>FSY</small>	o	o	o	o	o
[U/F VC 5pts] <small>UF5</small>	o	o	o	o	o
[SYN_U VC] <small>SYNU</small>	o	x	x	x	x
[U/F VC Energy Sav.] <small>ECO</small>	o	x	x	x	x
[Reluctance Motor] <small>SRVC</small>	o	x	x	x	x
[Output Ph Rotation] <small>PHR</small> <sup>(2)</sup>	o	o	o	o	o
[OutPhaseLoss Assign] <small>OPL</small>	▲	o	o	o	o
[2-Wire Control] <small>2C</small>	o	o	o	o	o
[3-Wire Control] <small>3C</small>	o	o	o	o	o
[Forced Local Assign] <small>FLO</small>	▲	▲	▲	▲	o
[Command Switching] <small>CCS</small>	▲	▲	▲	▲	o
[Freq Switch Assign] <small>RFC</small>	▲	▲	▲	▲	o
[Device Lock] <small>LES</small> <sup>(1)</sup>	o	•	•	• Emergency stop before <b>SLS</b> (see note)	• Emergency stop before <b>SMS</b> (see note)
				o Emergency stop during <b>SLS</b>	o Emergency stop during <b>SMS</b>
(1): STO: reference safety message about vertical axes, external mechanical protections shall be installed.					
(2): Check phase rotation setting in safety drive is same as phase rotation configured in safety module.					
<b>Legend:</b>					
• <b>O</b> : Compatible functions					
• <b>▲◀</b> : The function to which the arrow points takes precedence over the other function.					
• <b>•</b> : Safe state					

Table 4

	SAFETY MODULE USER FUNCTIONS				
	STO	SS1	SLS ramp	SLS steady	SMS
[OutPhaseLoss Assign] <i>OPL</i>	o	x	x	x	x
[Disable Error Detect] <i>INH</i> (2)	o	o	o	o	o
[Macro Configuration] <i>MCR</i>	o	o	o	o	o
[Parameters switching] <i>MLP</i>	o	o	o	o	o
[Ref. operations] <i>OAI</i>	▲	▲	▲	▲	o
[Motor short circuit] <i>SCF1</i>	o	o	o	o	o
[Ground Short Circuit] <i>SCF3</i>	o	o	o	o	o
[Motor Overspeed] <i>SOF</i>	▲	o	o	o	o
Configuration transfer (3)	o	o	o	o	o
[Limit switches] <i>LST</i> (1)	▲ <i>NST</i>  <i>RMP</i>  <i>FST</i>	• <i>NST</i>	• <i>NST</i>	• <i>NST</i> before <i>SLS</i> (see note).	• <i>NST</i> before <i>SMS</i> (see note).
		▲ <i>RMP</i>  <i>FST</i>	▲ <i>RMP</i>  <i>FST</i>	o <i>NST</i> during <i>SLS</i>  <i>RMP</i>  <i>FST</i>	o <i>NST</i> during <i>SMS</i>  <i>RMP</i>  <i>FST</i>
[Catch on the fly] <i>FLR</i>					
[Measured] <i>HWCOF</i>	▲	▲	o	o	o
[Computed] <i>SWCOF</i>	▲	x	x	x	x
[High Speed Switching] <i>CHS</i>	o	o	o	o	o
[Encoder check] <i>ENC</i>	o	o	o	o	o
[Reverse disable] <i>REIN</i>	o	o	o	o	o
[Backspin Control] <i>BSCC</i>	x	x	x	x	x
[Backlash compensation] <i>BSQM</i>	▲	▲	▲	o	o
[Fluxing by DI] <i>FLI</i>	▲	▲	o	o	o
[Memo reference frequency] <i>SPM</i>	o	o	▲	▲	o
[Stall monitoring] <i>STPR</i> (1)	▲	•	•	• Error before <i>SLS</i> (see note)	• Error before <i>SMS</i> (see note)
				o Error during <i>SLS</i> .	o Error during <i>SMS</i>

(1): See note of *NST*.

(2): Safety module error cannot be inhibited.

(3) Safety module and safety drive configuration are transferred . Need activation code.

**Legend:**

- **O**: Compatible functions
- **▲ ◀**: The function to which the arrow points takes precedence over the other function.
- **•**: Safe state
- **NST**: [Freewheel Stop]
- **DCI**: [DC injection]
- **LFF**: [Fallback speed]
- **RLS**: [Spd Maint Behavior]
- **RMP**: [Ramp Stop]
- **FST**: [Fast Stop Assign]

Table 5

	SAFETY MODULE USER FUNCTIONS				
	STO	SS1	SLS ramp	SLS steady	SMS
[Encoder monitoring] <i>SDD</i>	▲	x	x	x	x
[Brake logic control] <i>BLC</i>	o	o	o	o	o
[Torque control] <i>TOR</i> (2)	▲	x	x	x	o
[Auto DC injection] <i>ADC</i>	▲	▲	o	o	o
[DC injection] <i>DCI</i>	▲	x	x	x	x
[Motor tune] <i>MTU</i>	▲	▲	o	o	o
[Rotation Tune] <i>TRAM</i> (3)	▲	•	•	•	•
[External weight meas.] <i>ELM</i>	o	o	o	o	o
[Dec.Ramp Adapt] <i>BRA</i>	▲	▲	▲	o	o
[Out. Contactor Assign] <i>OCC</i>	o	◀	◀	◀	o
[Ramp] <i>RAMP</i>	▲	o	o	o	o
[Absolute] <i>ABS</i>	▲	o	o	o	o
[Frequency meter] <i>FQF</i> (1)	o	•	•	• Error before <i>SLS</i> (see note)	• Error before <i>SMS</i> (see note)
				o Error during <i>SLS</i> .	o Error during <i>SMS</i>
[Boost] <i>BOO</i>	▲	o	o	o	o
[Angle test setting] <i>ASA</i>					
[IPM align.] <i>IPMA</i>	▲	x	x	x	x
[SPM align.] <i>SPMA</i>	▲	x	x	x	x
[PSI align.] <i>PSI</i>	▲	o	o	o	o
[PSIO align.] <i>PSIO</i>	▲	o	o	o	o
[Rotational Current Injection] <i>RCI</i>	▲	o	o	o	o
<p>(1): See note of <i>NST</i>.</p> <p>(2): In case of torque control activation, <i>SMS</i> violation speed reaction should be configure to STO [SMS_VIOLATION_ERR_REACTION = STO]</p> <p>(3):</p> <ol style="list-style-type: none"> <li>Depending on Safety Functions and TRAM settings, some Safety Violations can be triggered during the tune in rotation.</li> <li>If the case 1- is encountered, it is recommended to execute the tune in rotation without activating the Safety functions.</li> <li>In case of speed estimation error by the safety module, it's recommended to remove the safety module to realize the tune in rotation.</li> </ol> <p><b>Legend:</b></p> <ul style="list-style-type: none"> <li>o: Compatible functions</li> <li>▲◀: The function to which the arrow points takes precedence over the other function.</li> <li>•: Safe state</li> </ul>					

**Table 6**

	SAFETY MODULE USER FUNCTIONS				
	STO	SS1	SLS ramp	SLS steady	SMS
[Stop on top Z] <small>TOST</small>	▲	▲	▲	o	o
[Spd Loop Optimization] <small>MCL</small>	o	o	o	o	o
Mechanical resonance rejection.	o	o	o	o	o
[Sleep menu] <small>SLP</small>	▲	▲	x	x	o
[Pumpcycle monitoring] <small>CSP</small>	o	o	o	o	o
[Master/Slave] <small>MSM</small> <sup>(1)</sup>	▲	x	x	x	x
[iPar Activation] <small>IPAV</small>	x	x	x	x	x
Fast device replacement	x	x	x	x	x
<b>[Diagnostics] <small>DAU</small></b>					
[Fan Diagnostics] <small>FNT</small>	o	o	o	o	o
[HMI LED diagnostics] <small>HLT</small>	o	o	o	o	o
[IGBT Diag w motor] <small>IWT</small> <sup>(2)</sup>	x	x	x	x	x
[IGBT Diag w/o motor] <small>IWOT</small> <sup>(2)</sup>	x	x	x	x	x
[Power Backup] <small>RFT</small>	▲	x	x	x	x
[Fieldbus Interrupt Resp] <small>CLL</small> <sup>(3)</sup>	•	•	•	•	•
<p>(1): For this version, Master slave function is incompatible with safety functions other than STO.</p> <p>(2): Safety module shall be unplugged to execute the diagnostic.</p> <p>(3): Reaction on PROFINet timeout is always STO because PROFIsafe communication is interrupted.</p> <p><b>Legend:</b></p> <ul style="list-style-type: none"> <li>• <b>O</b>: Compatible functions</li> <li>• <b>▲</b> ◀: The function to which the arrow points takes precedence over the other function.</li> <li>• <b>•</b>: Safe state</li> </ul>					

# PROFIsafe index

For the requests of the sub module (PROFIsafe module), here is the following index used:

PROFINet Record Index	Access Rule	Name	Description	Data Type	Identical to Drive Parameter
0x3BCA (15306)	Read	State SM	Safety module state: 0: Start 1: Not Ready to Switch On 2: Switch On Disabled 3: Ready To Switch On 5: Operation Enabled 7: Fault Reaction Active 8: Fault 10: SS1 active 11 STO active	Unsigned8 (0-255)	SSTA
0x3BCB (15307)	Read	SM Configuration State	Safety module configuration state: 0: Not configured 1: Not validated 2: Validated but not approved 3: Approved 4: No password configured	Unsigned8 (0-255)	SCNA
0x3BCC (15308)	Read	Safety Function Active	Safety module active function: 0: STO 1: No function active 3: SLS 5: SS1 8: SMS	Unsigned16 (0-65535)	SFCA
0x3BF6 (15350)	Read	STO trigger	Origin of Safe Torque Off activation: 0: STO is not requested 1: STO requested by [Safety Controller], Safety function or PROFIsafe protocol 2: Safety fault 3: PROFIsafe communication is not running.	Unsigned8 (0-255)	
0x3BF7 (15351)	Read	INTERNAL_FAULT	Error Group: Internal Fault 0. no fault 1. fault present	Bit	
0x3BF8 (15352)	Read	SAFETY_VIOLATION	Error Group: Safety Violation 0. no fault 1. fault present	Bit	

PROFINet Record Index	Access Rule	Name	Description	Data Type	Identical to Drive Parameter
0x3BF9 (15353)	Read	SAFETY_CONFIG	Error Group: Safety Config 0. no fault 1. fault present	Bit	
0x3BFA (15354)	Read	IO_FAULT	Error Group: IO Fault 0. no fault 1. fault present	Bit	

## Safety error list

PROFINet Record Index	Access Rule	Description	Data Type	Identical to Drive Parameter
0x3BE2 (15330)	Read	Safety Module Error number 0  SME0 is the latest error in the list	Unsigned16 (0x0000 - 0x07FF)	SME0
0x3BE3 (15331)	Read	Safety Module Error number 1	Unsigned16 (0x0000 - 0x07FF)	SME1
0x3BE4 (15332)	Read	Safety Module Error number 2	Unsigned16 (0x0000 - 0x07FF)	SME2
0x3BE5 (15333)	Read	Safety Module Error number 3	Unsigned16 (0x0000 - 0x07FF)	SME3
0x3BE6 (15334)	Read	Safety Module Error number 4	Unsigned16 (0x0000 - 0x07FF)	SME4
0x3BE7 (15335)	Read	Safety Module Error number 5	Unsigned16 (0x0000 - 0x07FF)	SME5
0x3BE8 (15336)	Read	Safety Module Error number 6	Unsigned16 (0x0000 - 0x07FF)	SME6
0x3BE9 (15337)	Read	Safety Module Error number 7	Unsigned16 (0x0000 - 0x07FF)	SME7
0x3BEA (15338)	Read	Safety Module Error number 8	Unsigned16 (0x0000 - 0x07FF)	SME8
0x3BEB (15339)	Read	Safety Module Error number 9  SME9 is the oldest error in the list	Unsigned16 (0x0000 - 0x07FF)	SME9

## CRC2 error buffer entry

PROFInet Record Index	Access Rule	Description	Data Type	Byte Offset	Name
0x64 (100)	Read	F_CRC_Seed = 1 : CN_incrNR_64	8 bytes	0	IMPLICIT 1
		F_CRC_Seed = 1 : CN_incrNR_64	8 bytes	8	IMPLICIT 2
		Expected CRC	4 bytes	16	CRC_Expected
		Wrong CRC	4 bytes	20	CRC_Received
		VERSION	2 bytes	24	value = 1
		Codename	4 bytes	26	

# Display

## LED Indicator

The following table shows the behavior of the LED indicators when the PROFIsafe module is plugged:

LED	Color & status	Description
System Fault	Off	The device does not have an IP address or powered off.
	RED ON	Error detected on the module
	Green ON	At least a port is connected and has a valid IP address.
	Green flickering	In combination with other LEDs: DCP manual identification phase / DCP flash mode or as long as the iPar-Client did not accomplish transfer (backup or restore) its parameters.
	Green/Red blinking	Power-up testing
	Green flashing 3 times	All ports are unplugged, but the module has an IP address
	Green flashing 4 times	Error detected: duplicate IP address
	Green flashing 5 times	The module is performing a DHCP sequence
Bus Fault	OFF	The device is powered off
	Red ON	The device has detected an ILF error
	Green ON	The device is ready and operational
	Red flickering	The device has detected a communication interruption / wrong configuration or a PROFINET controller at <i>Stop</i> state.
	Green flickering	In combination with other LEDs: DCP manual identification phase / DCP flash mode
	Green/Red blinking	Power up testing
	Red single flash	No connection to the PROFINET controller
ASF	OFF	Power stage unlocked.
	Solid Yellow	Power stage locked.
	Slow Blink Yellow	Safety Function Monitoring is on going.
	Fast Blink Yellow	Safety Configuration Modification is on going.

**NOTE:**

Communication status LEDs are used only to check the status for test operation and during troubleshooting.

Do not use them as operation indicators. Communication status LEDs are not provided as included in the safety system.

# Dedicated Safety Functions menu in the Display Terminal

## Overview

If the PROFIsafe module is inserted, the dedicated menu **[Safety Module]** OSM- accessible via the Display Terminal is displayed. The menu access is:

**[Complete settings]** CST- → **[Safety Module]** OSM-

This menu allows you to:

- Enable the PROFIsafe module by entering the activation code,
- Visualize the real-time status of the PROFIsafe module, the safety functions,
- Reset the safety configuration,
- Read the current PROFIsafe module errors.

## [Activation Code] SCAC

It is composed by 4 characters (letters and digits).

Entering the activation code enables the safety module and its safety functions (**[Safety Config Status]** SCNA switches to **[Activated]** APRV). Once the activation code validated, acceptance test must be done.

The activation code must be entered via a local connection.

The activation code is accessible if **[Safety Config Status]** SCNA is equal to **[Validated]** VAL. It means that the safety configuration has been transferred and this configuration has already been validated by the commissioning software.

After the activation code is entered at the Graphic Display Terminal, the safety drive may transition automatically to the operating state *Operation Enabled* if PROFIsafe communication is running. Depending on the wiring and the configuration of the safety drive, this may result in immediate operation.

### **▲ WARNING**

#### **UNANTICIPATED EQUIPMENT OPERATION**

- Verify that there are no persons or obstructions in the zone of operation before entering the activation code at the Graphic Display Terminal.
- Verify that you are fully aware of all consequences of entering the operating state *Operation Enabled*.

**Failure to follow these instructions can result in death, serious injury, or equipment damage.**

In case of transfer via the commissioning software, the activation code is displayed on the DTM inside the **Safety Conf** tab.

In case of configuration cloning, the activation code is displayed inside the safety report associated to the cloned configuration. It can also be displayed by connecting to the commissioning software inside the **Safety Conf** tab and is not requested by the display terminal .

## [Safety Module Status] SSTA

PROFIsafe module status.

The PROFIsafe module status is different from the safety drive status.

Code / Value	Description
[Starting] STRT	Initialization ongoing but not completed.
[Not Rdy To Switch On] NRSO	PROFIsafe module initialization is completed.
[Switch On Disabled] SOD	<p>Safety module and safety drive initialization are completed but PROFIsafe controller has not started the cyclical exchanges with the safety drive.</p> <ul style="list-style-type: none"> <li>PROFIsafe controller has disabled the safety module due to timeout or telegram corruption. The safety controller must acknowledge the reintegration to enable the safety module.</li> <li>PROFIsafe controller has disabled the safety module due to the PLC program (Failsafe value output activated).</li> <li>SS1 function has been completed and its request has not been deactivated.</li> </ul>
[Ready To Switch On] RTSO	Configuration of PROFIsafe module is completed it is an intermediate state before authorizing operation.
[Operation Enabled] OPEN	Safety drive is in operational mode. STO is deactivated.
[Fault] FLT	Safety error triggered.
[STO Active] STO	Safety function STO is active.
[SS1 Active] SS1	Safety function SS1 is active.

## [Safety Config Status] SCNA

Safety configuration status.

Code / Value	Description
[No Password] NOPW	<p>No password defined and no configuration.</p> <p><b>Factory setting.</b></p>
[No Configuration] NCF	Password defined but no configuration.
[Not Validated] NVAL	Configuration not validated by the commissioning software. The readback values must be acknowledged .
[Validated] VAL	PROFIsafe module validated, it needs to be activated (with the activation code).
[Activated] APRV	PROFIsafe module activated.

## [Active Safety Fct] SFCA

Active safety function.

It shows the activation state of the STO function.

Code / Value	Description
[None] F001	No safety function is active.
[STO] F000	Safety function STO is active.
[SLS] F003	Safety function SLS is active.
[SS1] F005	Safety function SS1 is active.
[SMS] F008	Safety function SMS is active.

## [Active F\_D\_Address] FDAD

### Active F\_Destination\_Address

This parameter displays the configured F-address of the safety drive.

Code / Value	Description
[Not Configured] NOCF	The F-address is not configured.
1...65534	The F-address value.

## [Safety Config Reset] SFRS

### Safety configuration reset

Reset of the safety configuration. It resets only the parameters related to the PROFIsafe module.

This parameter can be accessed if [Access Level] LAC is set to [Expert] EPR.

Code / Value	Description
[No] NO	Not active.
[Yes] YES	Request to reset the safety configuration. <b>Note:</b> This setting is possible only if motor is not running and whatever PROFIsafe communication state.

## [Safety Module Errors] SME- menu

This menu contains additional information about the current detected errors related to the PROFIsafe module by:

- [Safety Module Error] SMLE, and/or
- [Safety Module Error 0] SME0 to [Safety Module Error 9] SME9.

It corresponds to current errors triggered by PROFIsafe module. When SME<sub>x</sub> is different than 0, the [Safety Module Status] SSTA is set to [Fault] FLT.

The list of error codes is available in the section Detected Error.

## [PROFIsafe Com State] SSM1

### PROFIsafe Communication State

This parameter represents the safety drive communication current state.

This parameter is only used to verify the status for test operation. **Do not use this parameter as operation indicator.**

The different safety drive states are:

Code / Value	Description
[Disabled] S001	PROFIsafe communication is not configured. It is disabled until the F_Address is configured by the commissioning software of the safety module.
[Waiting F-Params] S002	The safety drive is waiting for PROFIsafe communication parameters from the safety controller.
[Invalid F-Params] S003	Invalid PROFIsafe parametrization.
[Configured] S004	The PROFIsafe communication has been properly configured.
[Data Exchange] S005	<ul style="list-style-type: none"> <li>• PROFIsafe cyclical data are exchanged.</li> <li>• AND data are valid.</li> <li>• AND IOPS are GOOD.</li> </ul>
[Stopped] S006	<ul style="list-style-type: none"> <li>• PROFIsafe cyclical data are exchanged.</li> <li>• EITHER data are NOT valid.</li> <li>• OR IOPS are BAD.</li> </ul>
[Fail-Safe] S007	PROFIsafe fail safe state.

## [Safety Com Map] SCM- menu

[Cmd Word 1-0] SCW0 to [Cmd Word 13-12] SCW6. 

It mirrors the safety command word exchanged between PLC and the safety drive.

[Status Word 1-0] SSW0 to [Status Word 13-12] SSW6. 

It mirrors the safety status word exchanged between PLC and the safety drive.

## [Safety Config Test] SCT menu

This menu can be accessed if [Access Level] LAC is set to [Expert] EPR.

This menu gives access to the safety configuration test function. This function can help during the tests of your safety configuration. It is used to:

- substitute the deceleration commanded ramp set by the safety module by [Test Ramp Cmd] FSRC value if configured, and
- ignore the limitation to the set point requested by the safety module by the reference frequency set by the drive application.

Once the acceptance tests are done, this function must be disabled by setting [Test Cmd Activation] FSCA to [Not Assigned] NO.

**NOTE:** After a power cycle, the setting of the parameters [Test Cmd Activation] FSCA and [Test Ramp Cmd] FSRC is reset.

## Status of the safety drive

This function only operates if the digital input or the virtual digital input assigned to **[Test Cmd Activation] FSCA** is activated and if the safety module gives the frequency reference to reach or a deceleration commanded ramp to follow (e.g. if the safety function SS1 or the safety function SLS is operating).

if the digital input or the virtual digital input assigned to **[Test Cmd Activation] FSCA** is activated, **[Device State] HMIS** displays **[Safety Config Test] SCTP**.

## Parameters

Parameter	<b>[Test Cmd Activation] FSCA</b>
<b>Description</b>	Configure the digit input or the virtual digital input assigned to the activation of the safety configuration test function. <b>NOTE:</b> This parameter can only be modified if the motor is not running.
<b>Setting</b>	<ul style="list-style-type: none"> <li>• <b>[Not Assigned] NO:</b> Not assigned (<b>Factory Setting</b>)</li> <li>• <b>[Yes] YES:</b> Function always active</li> <li>• <b>[DI1] LI1 ... [DI8] LI8:</b> Digital input DI1...DI8 (depending on the product number of the drive)</li> <li>• <b>[DI11] LI11 ... [DI16] LI16:</b> Digital input DI11...DI16 if VW3A3203 I/O extension module has been inserted</li> <li>• <b>[CD00] CD00 ... [CD10] CD10:</b> Virtual digital input CMD.0...CMD.10 in I/O profile IO configuration</li> <li>• <b>[CD11] CD11 ... [CD15] CD15:</b> Virtual digital input CMD.11...CMD.15 regardless of configuration</li> <li>• <b>[C111] C111 ... [C115] C115:</b> Virtual digital input CMD1.11...CMD1.15 with integrated Modbus Serial regardless of configuration</li> <li>• <b>[C101] C101 ... [C110] C110:</b> Virtual digital input CMD1.01...CMD1.10 with integrated Modbus Serial in I/O profile IO configuration</li> <li>• <b>[C201] C201 ... [C210] C210:</b> Virtual digital input CMD2.01...CMD2.10 with CANopen® fieldbus module in I/O profile IO configuration</li> <li>• <b>[C211] C211 ... [C215] C215:</b> Virtual digital input CMD2.11...CMD2.15 with CANopen® fieldbus module regardless of configuration</li> <li>• <b>[C301] C301 ... [C310] C310:</b> Virtual digital input CMD3.01...CMD3.10 with a fieldbus module in I/O profile IO configuration</li> <li>• <b>[C311] C311 ... [C315] C315:</b> Virtual digital input CMD3.11...CMD3.15 with a fieldbus module regardless of configuration</li> <li>• <b>[C501] C501 ... [C510] C510:</b> Virtual digital input CMD5.01...CMD5.10 with integrated Ethernet in I/O profile IO configuration (this selection can be accessed on ATV340...N4E drives).</li> <li>• <b>[C511] C511 ... [C515] C515:</b> Virtual digital input CMD5.11...CMD5.15 with integrated Ethernet regardless of configuration (this selection can be accessed on ATV340...N4E drives).</li> </ul>

Parameter	<b>[Test Ramp Cmd] FSRC</b>
<b>Description</b>	Configure the deceleration commanded ramp replacing the one requested by the safety module.  This parameter is forced to <b>[No] NO</b> if <b>[Test Cmd Activation] FSCA</b> is set to <b>[Not Assigned] NO</b> .
<b>Setting</b>	<ul style="list-style-type: none"> <li>• <b>[No] NO:</b> Not used (<b>Factory Setting</b>)</li> <li>• 0.1 Hz/s up to 20,000 Hz/s (step: 0.1 Hz/s): Setting range</li> </ul>

## Behavior of the function with SS1

During SS1 operation, if the safety configuration test function is activated (the input or bit assigned to **[Test Cmd Activation] FSCA** switches to high-level), the deceleration is done following **[Test Ramp Cmd] FSRC**. The following figure shows this behavior.

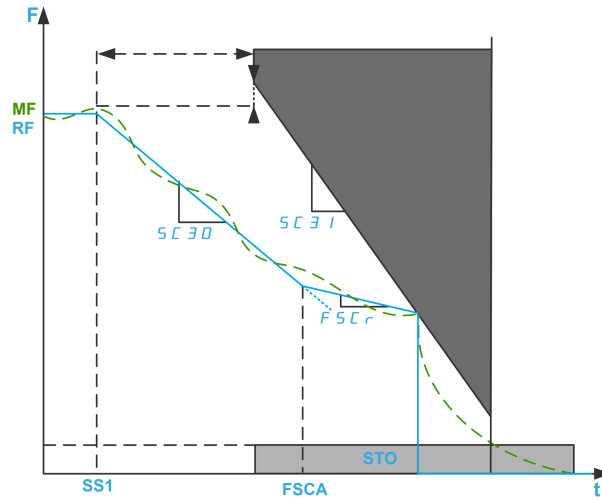

**F:** Frequency / **MF:** Motor Frequency / **RF:** Reference Frequency

**SS1:** activation of SS1

**FSCA:** activation of the safety configuration test function

If the safety configuration test function is activated before SS1 activation, then at SS1 activation, the deceleration is immediately done following **[Test Ramp Cmd] FSRC**.

**NOTE:** if the parameter **[SS1 drive control] SC36** of the safety function SS1 is set to External or if the parameter **[Test Ramp Cmd] FSRC** is set to **[No] NO**, this function has no effect during SS1 operation.

**Behavior of the function with SLS**

During SLS operation, if the safety configuration test function is activated, then reference frequency applied to the motor is set by the application of the drive. In case of deceleration, if the reference frequency greater than **[SLS positive set point] SC50** and if **[Test Ramp Cmd] FSRC** is different from **[No] NO** the deceleration follows **[Test Ramp Cmd] FSRC** value else the deceleration is done following the application deceleration.

**NOTE:** This function is also possible for negative setpoint.

The following figure shows an example with SLS type 2.

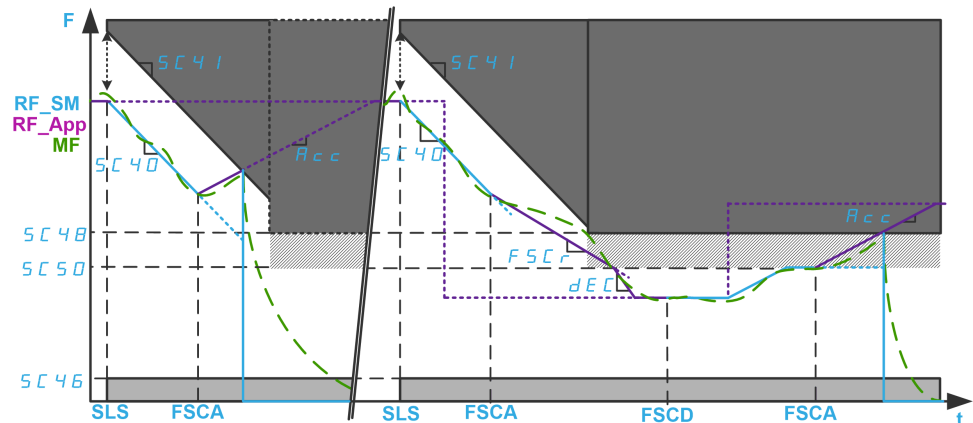

**F:** Frequency / **MF:** Motor Frequency

**RF\_SM:** Reference Frequency set by the safety module / **RF\_APP:** Reference Frequency set by the application of the drive

**ACC:** Acceleration / **DEC:** Deceleration

**SLS:** activation of SLS

**FSCA/FSCD:** activation/deactivation of the safety configuration test function

# Commissioning and Display

## What's in This Part

Configuration of the safety system .....	81
Acceptance Test.....	96

# Configuration of the safety system

## What's in This Chapter

Prerequisites to configure the safety drive .....	82
Commissioning the safety drive .....	83

## Overview

To configure the safety drive, follow the following steps:

Step	With/ Without PROFIsafe Module inserted	Action
1	Without	Configure the Drive Motor Control using SoMove or Graphic Display Terminal - including IP settings  For more information, refer to ATV340 Programming manual.
2	Without	Configure and test Drive Motor control using with SoMove / Graphic Display Terminal.
3	—	Power off and insert PROFIsafe module.
4	With	Configure the safety drive using TIA Portal or SoMove.
5	With	Test PROFIsafe system.

## Prerequisites to configure the safety drive

The user must be qualified to configure the safety functions.

The safety drive firmware version to support the PROFIsafe module is **V4.3** or higher.

The PROFINet module VW3A3647 needs to be plugged. The firmware version compatible with the PROFIsafe module is **V3.2** or higher. More details about the installation on the ATV340 PROFINET manual.

After installing and plugging the PROFIsafe module in the safety drive, verify the safety drive firmware on the display terminal via **[Diagnostics] DIA- → [Diag. data] DDT- → [Identification] OID**.

When the safety drive has a firmware version that does not support the PROFIsafe module, the **[Internal Error 6] INF6** error is triggered (see ) and a firmware update is required of the PROFINet module if not the **V3.2** or the safety drive if not **V4.3**. The firmware update can be done through the Ecostruxure Automation Device Maintenance (more details about the firmware update in Ecostruxure Automation Device Maintenance Altivar User Manual), if the update has not succeeded, please contact your local Schneider Electric service.

Before starting to configure the parameters of the PROFIsafe module, configure the standard parameters of the safety drive.

This part can be configured using the Schneider\_Electric\_Altivar\_Machine\_ATV340\_DTM\_Library\_V4.1 compatible with the safety drive. For more details about parameters, refer to ATV340 Programming manual.

Use the links below to download these files:

Files	Links
SoMove: FDT	SoMove_FDT (English, French, German, Spanish, Italian, Chinese)
Altivar 340: DTM	ATV340_DTM_Library_EN (English) ATV340_DTM_Lang_FR (French) ATV340_DTM_Lang_DE (German) ATV340_DTM_Lang_SP (Spanish) ATV340_DTM_Lang_IT (Italian) ATV340_DTM_Lang_CN (Chinese)
GSDML file	PROFINET GSDML VW3A3647 files

# Commissioning the safety drive

The configuration of some parameters is required to establish PROFIsafe communication between the safety PLC and the safety drive. It is done mainly via TIA Portal and the DTM.

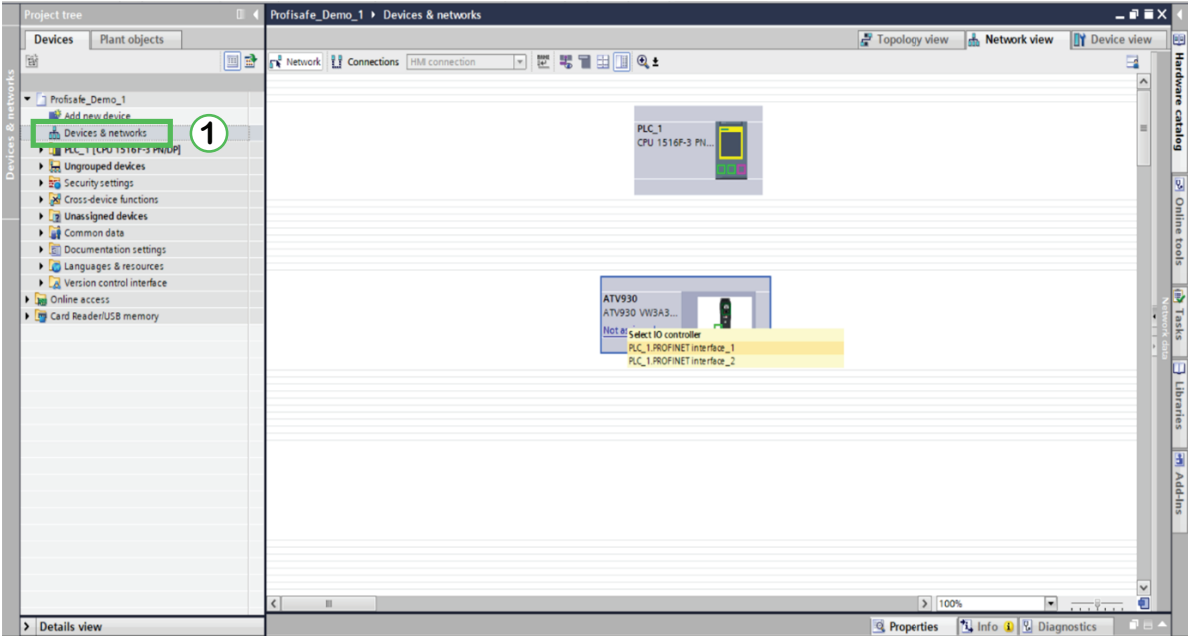
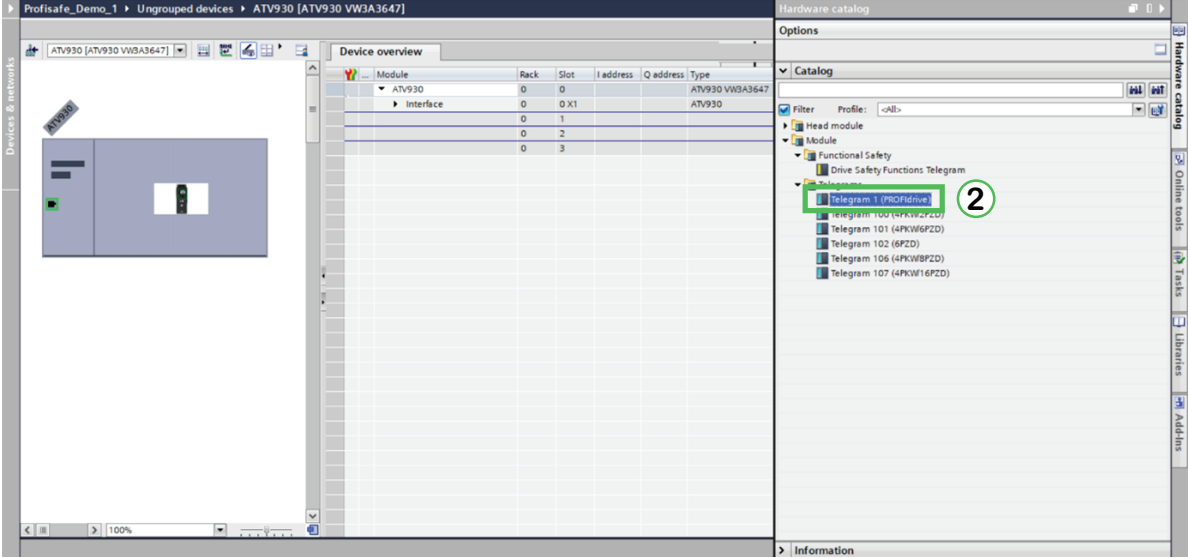
Step	Action																																				
1	<p>To configure the safety drive, it is necessary to download the PROFINET GSDML VW3A3647 files from se.com.</p> 																																				
2	<p>Add a standard Telegram. For more details about different telegrams, refer to ATV340 Profinet VW3A3647 manual.</p>  <table border="1" data-bbox="268 1227 1045 1713"> <thead> <tr> <th>Module</th> <th>Rack</th> <th>Slot</th> <th>I address</th> <th>Q address</th> <th>Type</th> </tr> </thead> <tbody> <tr> <td>ATV930</td> <td>0</td> <td>0</td> <td></td> <td></td> <td>ATV930 VW3A3647</td> </tr> <tr> <td>  Interface</td> <td>0</td> <td>0 X1</td> <td></td> <td></td> <td>ATV930</td> </tr> <tr> <td>  </td> <td>0</td> <td>1</td> <td></td> <td></td> <td></td> </tr> <tr> <td>  </td> <td>0</td> <td>2</td> <td></td> <td></td> <td></td> </tr> <tr> <td>  </td> <td>0</td> <td>3</td> <td></td> <td></td> <td></td> </tr> </tbody> </table>	Module	Rack	Slot	I address	Q address	Type	ATV930	0	0			ATV930 VW3A3647	Interface	0	0 X1			ATV930		0	1					0	2					0	3			
Module	Rack	Slot	I address	Q address	Type																																
ATV930	0	0			ATV930 VW3A3647																																
Interface	0	0 X1			ATV930																																
	0	1																																			
	0	2																																			
	0	3																																			

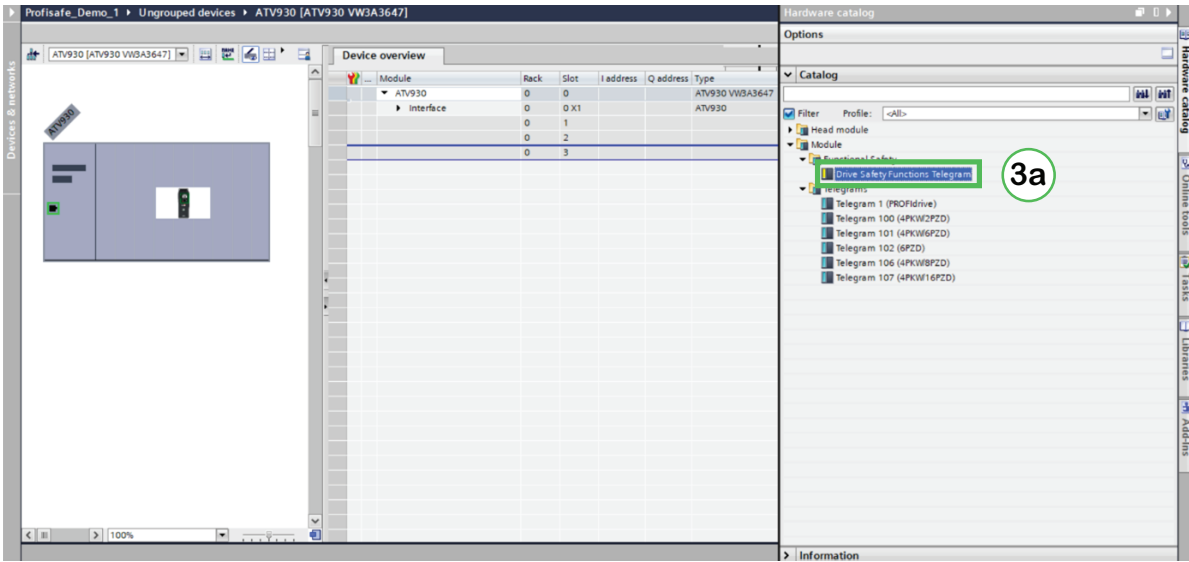
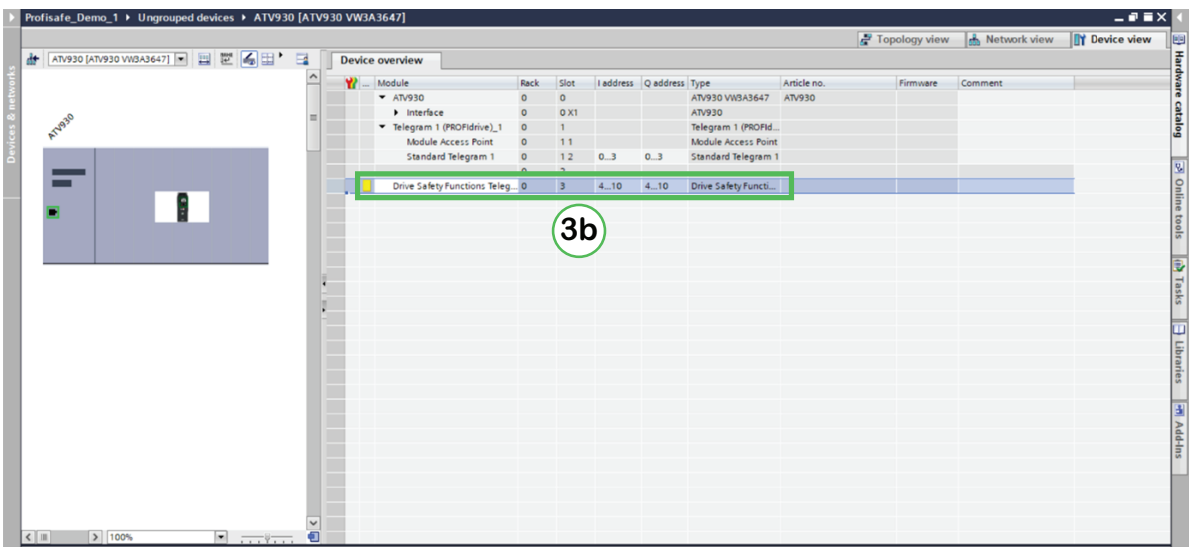
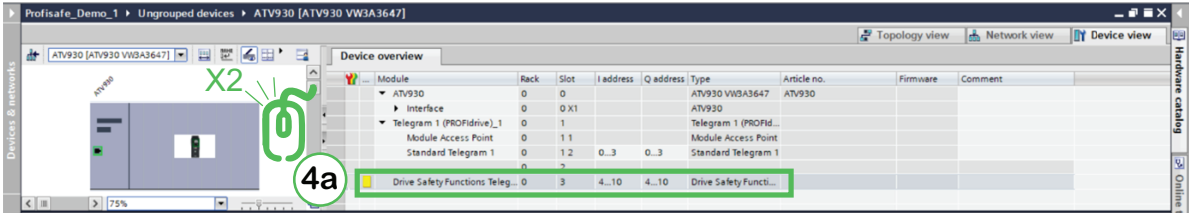
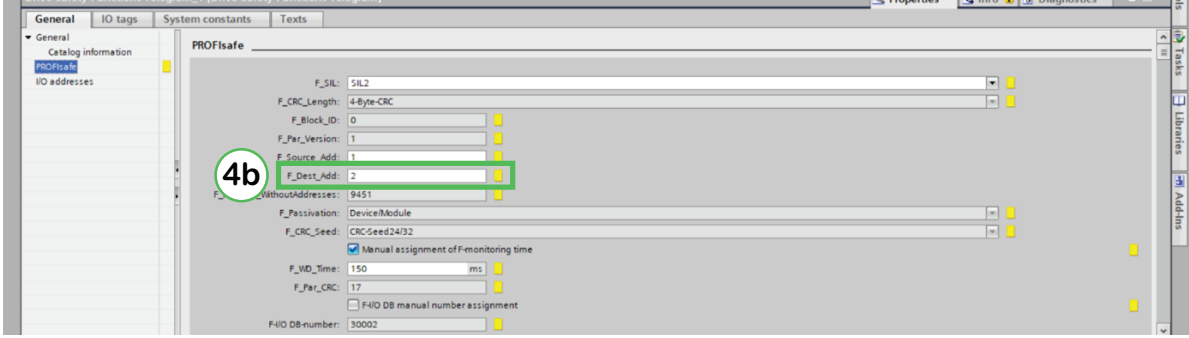
Step	Action
3	<p>Select and add the drive safety functions telegram.</p>  <p>3a</p>  <p>3b</p>
4	<p>Set the <i>F_Dest_Address</i> of the safety drive.</p>  <p>4a</p>  <p>4b</p> <p><b>NOTE:</b> each safety drive must have a unique <i>F_Dest_Address</i> on the network.</p>

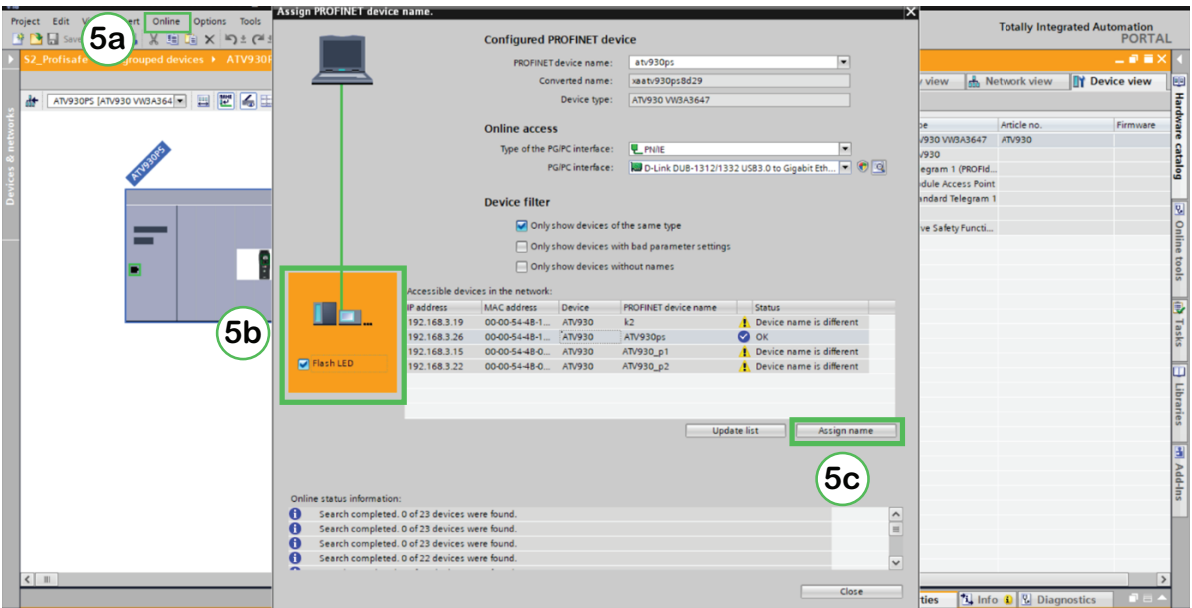
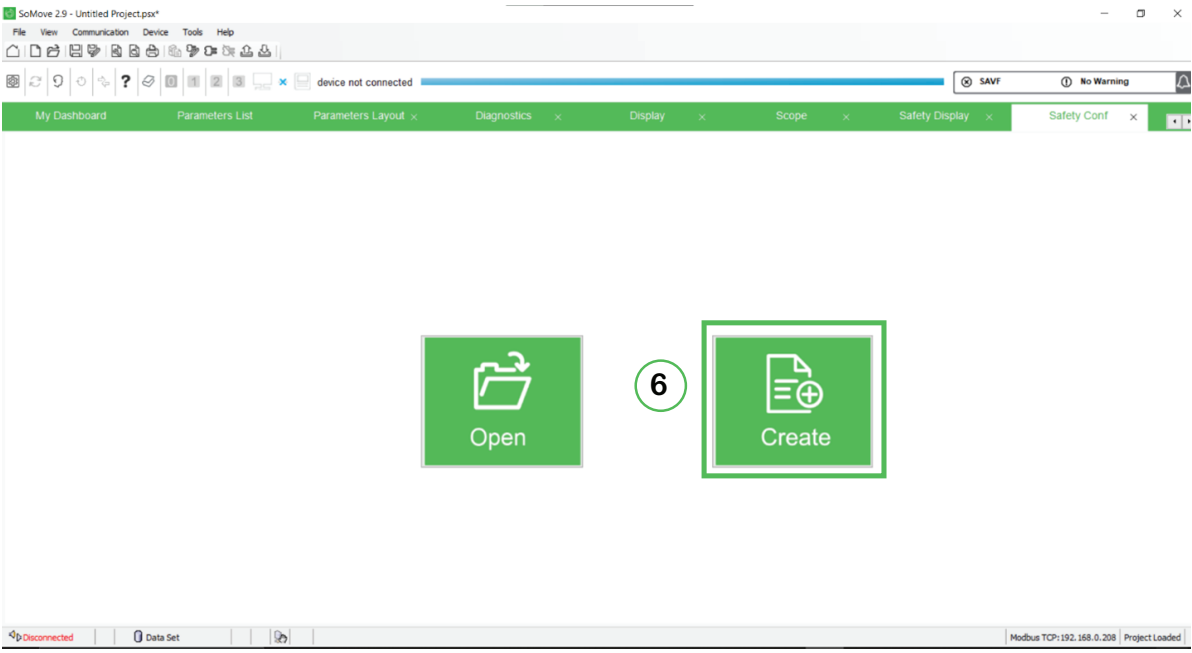
Step	Action																									
<p>5</p>	<p>Download the program to the PLC then go Online. The device can be located using the Flash LED. To establish the connection, the station name must be assigned.</p>  <table border="1" data-bbox="678 526 1141 638"> <thead> <tr> <th>IP address</th> <th>MAC address</th> <th>Device</th> <th>PROFINET device name</th> <th>Status</th> </tr> </thead> <tbody> <tr> <td>192.168.3.19</td> <td>00-00-54-48-1...</td> <td>ATV930</td> <td>I2</td> <td>Device name is different</td> </tr> <tr> <td>192.168.3.26</td> <td>00-00-54-48-1...</td> <td>ATV930</td> <td>ATV930ps</td> <td>OK</td> </tr> <tr> <td>192.168.3.15</td> <td>00-00-54-48-0...</td> <td>ATV930</td> <td>ATV930_p1</td> <td>Device name is different</td> </tr> <tr> <td>192.168.3.22</td> <td>00-00-54-48-0...</td> <td>ATV930</td> <td>ATV930_p2</td> <td>Device name is different</td> </tr> </tbody> </table>	IP address	MAC address	Device	PROFINET device name	Status	192.168.3.19	00-00-54-48-1...	ATV930	I2	Device name is different	192.168.3.26	00-00-54-48-1...	ATV930	ATV930ps	OK	192.168.3.15	00-00-54-48-0...	ATV930	ATV930_p1	Device name is different	192.168.3.22	00-00-54-48-0...	ATV930	ATV930_p2	Device name is different
IP address	MAC address	Device	PROFINET device name	Status																						
192.168.3.19	00-00-54-48-1...	ATV930	I2	Device name is different																						
192.168.3.26	00-00-54-48-1...	ATV930	ATV930ps	OK																						
192.168.3.15	00-00-54-48-0...	ATV930	ATV930_p1	Device name is different																						
192.168.3.22	00-00-54-48-0...	ATV930	ATV930_p2	Device name is different																						
<p>6</p>	<p>Open SoMove with the according DTM, navigate to the <b>Safety Conf</b> and Create New Safety Configuration.</p> 																									

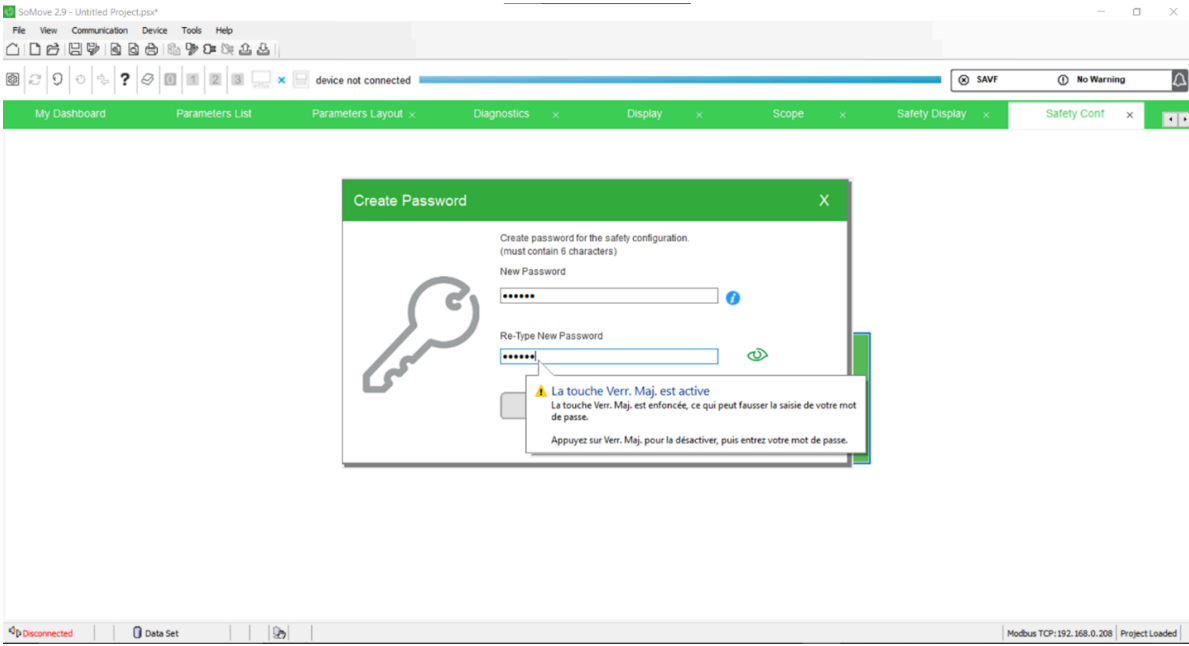
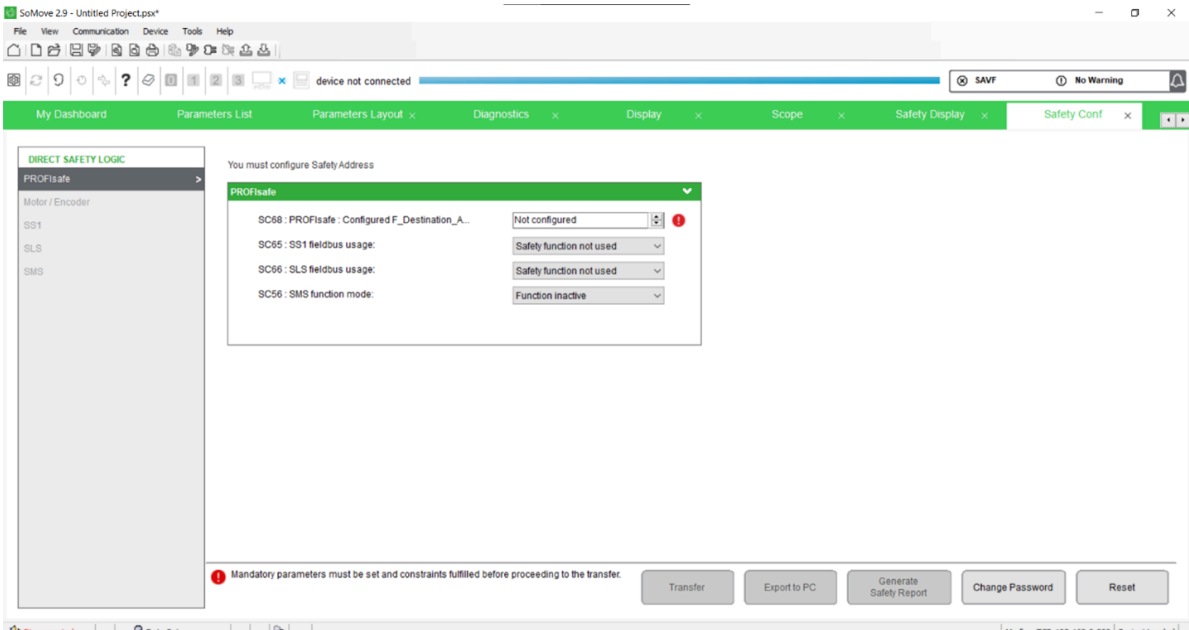
Step	Action
7	<p>Create a Password according to the information button. If you have clicked on Create button, a Create Password dialog box is displayed:</p> <ul style="list-style-type: none"> <li>Type the new configuration password in New Password box.</li> <li>Retype this configuration password in Re-Type New Password box.</li> <li>Click OK.</li> </ul> <p>Take carefully note of it inside the machine maintenance guide.</p> <p><b>NOTE:</b> It is recommended to have a unique password for each safety drive on the network.</p> <p><b>NOTE:</b></p> <p>The password must contain:</p> <ul style="list-style-type: none"> <li>6 Characters,</li> <li>At least 1 number</li> <li>At least 1 alphabetical character,</li> <li>At least 1 special character (such as !, ?, /, -)</li> </ul> <p>Example of password: ATV01#</p> 
8	<p>Configure the SC68 F_address parameter already configured in TIA Portal.</p> <p><b>NOTE:</b> each safety drive must have a unique F_Dest_Address on the network. the PROFIsafe address is a type 1: F_Dest_Address only</p> 

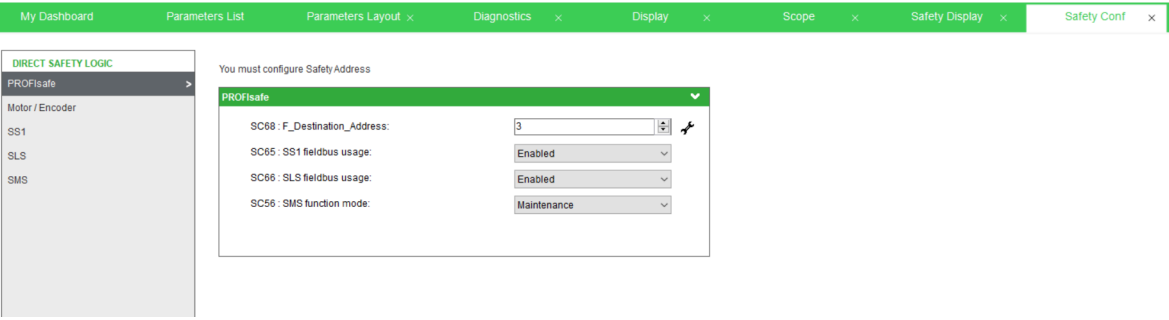
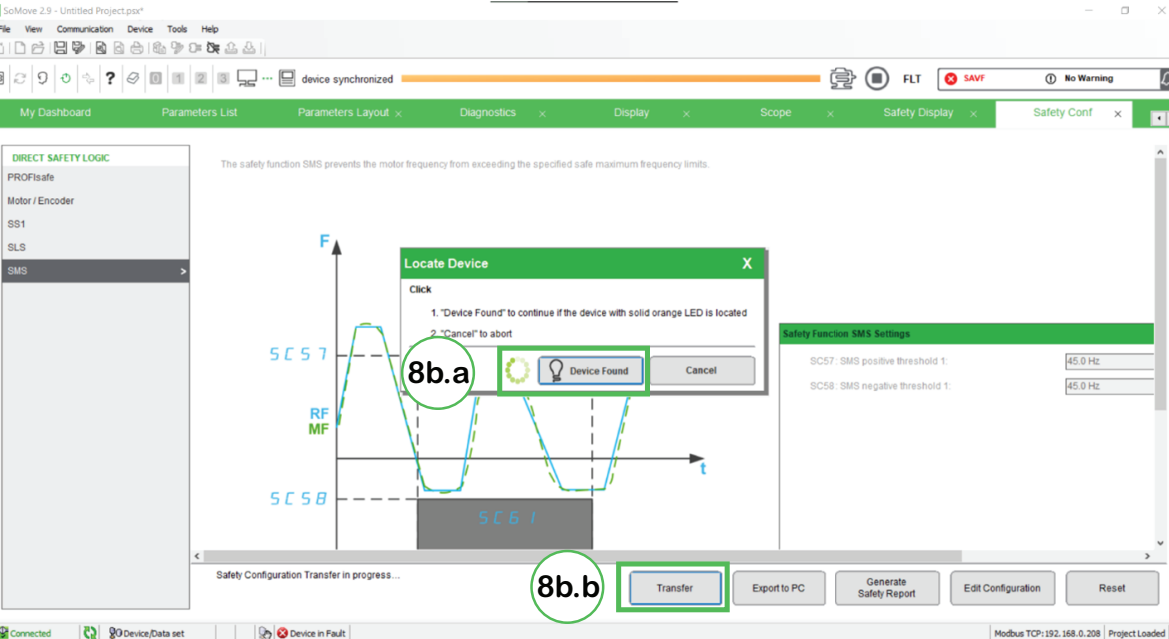
Step	Action
8.b	<p>In case of SS1/SLS/SMS functions usage:                      Activate the SC65, SC66, SC56 parameters.</p>  <p>The screenshot shows the 'Safety Conf' tab in the software. On the left, a tree view under 'DIRECT SAFETY LOGIC' has 'PROFIsafe' expanded to show 'Motor / Encoder', 'SS1', 'SLS', and 'SMS'. The main area displays configuration for 'PROFIsafe' with the following settings:</p> <ul style="list-style-type: none"> <li>SC68 : F_Destination_Address: 3</li> <li>SC65 : SS1 fieldbus usage: Enabled</li> <li>SC66 : SLS fieldbus usage: Enabled</li> <li>SC56 : SMS function mode: Maintenance</li> </ul>
8.c	<p>Configure SS1, SLS, SMS in their own tab and transfer the configuration to the Safety module. A pop up to locate the device is displayed and the LED Status of the safety drive is blinking in orange to visually confirm the safety drive being configured.</p>  <p>The screenshot shows the 'Safety Conf' tab with the 'SMS' parameter selected in the left tree. A 'Locate Device' pop-up window is active, displaying instructions: 'Click 1. "Device Found" to continue if the device with solid orange LED is located 2. "Cancel" to abort'. The 'Device Found' button is highlighted with a green circle labeled '8b.a'. Below the pop-up is a graph of frequency (F) vs. time (t) showing a pulse with a peak labeled 'SC57' and a trough labeled 'SC58'. A 'Safety Function SMS Settings' panel on the right shows 'SC57 : SMS positive threshold 1: 45.0 Hz' and 'SC58 : SMS negative threshold 1: 45.0 Hz'. At the bottom, a 'Transfer' button is highlighted with a green circle labeled '8b.b'. The status bar at the bottom indicates 'Modbus TCP:192.168.0.208   Project Loaded'.</p>

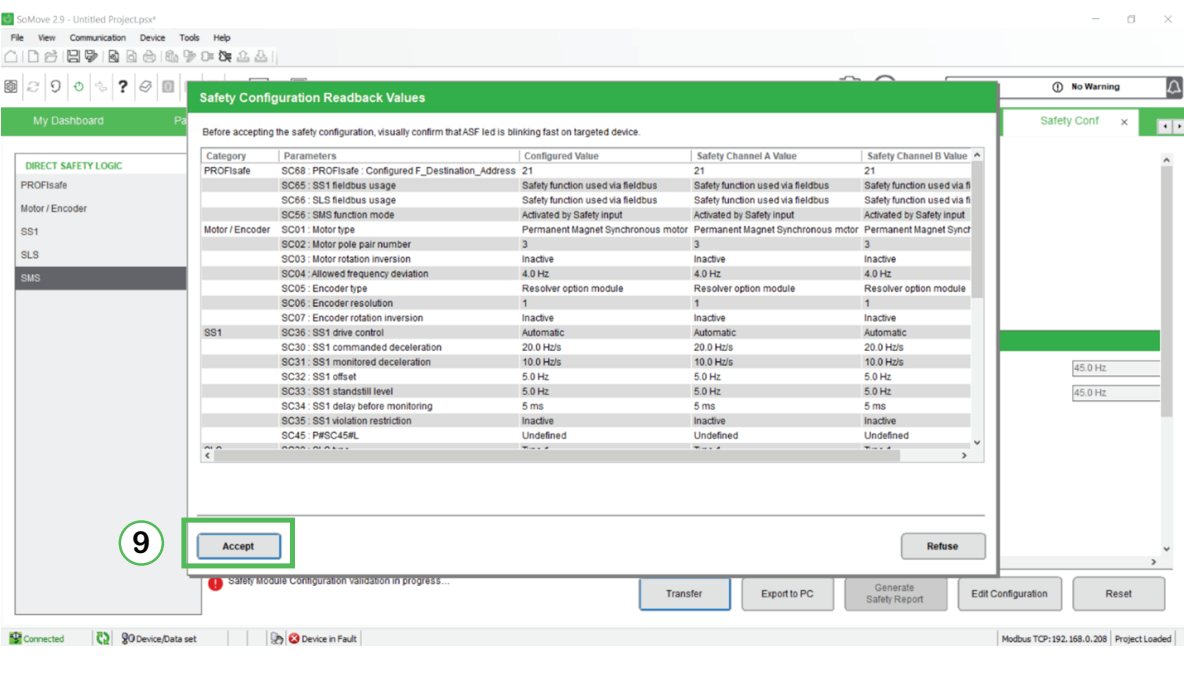
Step	Action																																																																																																				
9	<p>After clicking on device found → Safety configuration Readback values table shows according to the configuration done in the steps above → Accept or Refuse in case of you need to add some modifications.</p>  <table border="1" data-bbox="438 392 1236 728"> <thead> <tr> <th>Category</th> <th>Parameters</th> <th>Configured Value</th> <th>Safety Channel A Value</th> <th>Safety Channel B Value</th> </tr> </thead> <tbody> <tr> <td>PROFIsafe</td> <td>SC68 : PROFIsafe : Configured F_Destination_Address</td> <td>21</td> <td>21</td> <td>21</td> </tr> <tr> <td></td> <td>SC65 : SLS fieldbus usage</td> <td>Safety function used via fieldbus</td> <td>Safety function used via fieldbus</td> <td>Safety function used via fieldbus</td> </tr> <tr> <td></td> <td>SC66 : SLS fieldbus usage</td> <td>Safety function used via fieldbus</td> <td>Safety function used via fieldbus</td> <td>Safety function used via fieldbus</td> </tr> <tr> <td></td> <td>SC55 : SMS function mode</td> <td>Activated by Safety input</td> <td>Activated by Safety input</td> <td>Activated by Safety input</td> </tr> <tr> <td>Motor / Encoder</td> <td>SC01 : Motor type</td> <td>Permanent Magnet Synchronous motor</td> <td>Permanent Magnet Synchronous motor</td> <td>Permanent Magnet Synchronous motor</td> </tr> <tr> <td></td> <td>SC02 : Motor pole pair number</td> <td>3</td> <td>3</td> <td>3</td> </tr> <tr> <td></td> <td>SC03 : Motor rotation inversion</td> <td>Inactive</td> <td>Inactive</td> <td>Inactive</td> </tr> <tr> <td></td> <td>SC04 : Allowed frequency deviation</td> <td>4.0 Hz</td> <td>4.0 Hz</td> <td>4.0 Hz</td> </tr> <tr> <td></td> <td>SC05 : Encoder type</td> <td>Resolver option module</td> <td>Resolver option module</td> <td>Resolver option module</td> </tr> <tr> <td></td> <td>SC06 : Encoder resolution</td> <td>1</td> <td>1</td> <td>1</td> </tr> <tr> <td></td> <td>SC07 : Encoder rotation inversion</td> <td>Inactive</td> <td>Inactive</td> <td>Inactive</td> </tr> <tr> <td>SS1</td> <td>SC36 : SS1 drive control</td> <td>Automatic</td> <td>Automatic</td> <td>Automatic</td> </tr> <tr> <td></td> <td>SC30 : SS1 commanded deceleration</td> <td>20.0 Hz/s</td> <td>20.0 Hz/s</td> <td>20.0 Hz/s</td> </tr> <tr> <td></td> <td>SC31 : SS1 monitored deceleration</td> <td>10.0 Hz/s</td> <td>10.0 Hz/s</td> <td>10.0 Hz/s</td> </tr> <tr> <td></td> <td>SC32 : SS1 offset</td> <td>5.0 Hz</td> <td>5.0 Hz</td> <td>5.0 Hz</td> </tr> <tr> <td></td> <td>SC33 : SS1 standstill level</td> <td>5.0 Hz</td> <td>5.0 Hz</td> <td>5.0 Hz</td> </tr> <tr> <td></td> <td>SC34 : SS1 delay before monitoring</td> <td>5 ms</td> <td>5 ms</td> <td>5 ms</td> </tr> <tr> <td></td> <td>SC35 : SS1 violation restriction</td> <td>Inactive</td> <td>Inactive</td> <td>Inactive</td> </tr> <tr> <td></td> <td>SC45 : P#SC45#L</td> <td>Undefined</td> <td>Undefined</td> <td>Undefined</td> </tr> </tbody> </table>	Category	Parameters	Configured Value	Safety Channel A Value	Safety Channel B Value	PROFIsafe	SC68 : PROFIsafe : Configured F_Destination_Address	21	21	21		SC65 : SLS fieldbus usage	Safety function used via fieldbus	Safety function used via fieldbus	Safety function used via fieldbus		SC66 : SLS fieldbus usage	Safety function used via fieldbus	Safety function used via fieldbus	Safety function used via fieldbus		SC55 : SMS function mode	Activated by Safety input	Activated by Safety input	Activated by Safety input	Motor / Encoder	SC01 : Motor type	Permanent Magnet Synchronous motor	Permanent Magnet Synchronous motor	Permanent Magnet Synchronous motor		SC02 : Motor pole pair number	3	3	3		SC03 : Motor rotation inversion	Inactive	Inactive	Inactive		SC04 : Allowed frequency deviation	4.0 Hz	4.0 Hz	4.0 Hz		SC05 : Encoder type	Resolver option module	Resolver option module	Resolver option module		SC06 : Encoder resolution	1	1	1		SC07 : Encoder rotation inversion	Inactive	Inactive	Inactive	SS1	SC36 : SS1 drive control	Automatic	Automatic	Automatic		SC30 : SS1 commanded deceleration	20.0 Hz/s	20.0 Hz/s	20.0 Hz/s		SC31 : SS1 monitored deceleration	10.0 Hz/s	10.0 Hz/s	10.0 Hz/s		SC32 : SS1 offset	5.0 Hz	5.0 Hz	5.0 Hz		SC33 : SS1 standstill level	5.0 Hz	5.0 Hz	5.0 Hz		SC34 : SS1 delay before monitoring	5 ms	5 ms	5 ms		SC35 : SS1 violation restriction	Inactive	Inactive	Inactive		SC45 : P#SC45#L	Undefined	Undefined	Undefined
Category	Parameters	Configured Value	Safety Channel A Value	Safety Channel B Value																																																																																																	
PROFIsafe	SC68 : PROFIsafe : Configured F_Destination_Address	21	21	21																																																																																																	
	SC65 : SLS fieldbus usage	Safety function used via fieldbus	Safety function used via fieldbus	Safety function used via fieldbus																																																																																																	
	SC66 : SLS fieldbus usage	Safety function used via fieldbus	Safety function used via fieldbus	Safety function used via fieldbus																																																																																																	
	SC55 : SMS function mode	Activated by Safety input	Activated by Safety input	Activated by Safety input																																																																																																	
Motor / Encoder	SC01 : Motor type	Permanent Magnet Synchronous motor	Permanent Magnet Synchronous motor	Permanent Magnet Synchronous motor																																																																																																	
	SC02 : Motor pole pair number	3	3	3																																																																																																	
	SC03 : Motor rotation inversion	Inactive	Inactive	Inactive																																																																																																	
	SC04 : Allowed frequency deviation	4.0 Hz	4.0 Hz	4.0 Hz																																																																																																	
	SC05 : Encoder type	Resolver option module	Resolver option module	Resolver option module																																																																																																	
	SC06 : Encoder resolution	1	1	1																																																																																																	
	SC07 : Encoder rotation inversion	Inactive	Inactive	Inactive																																																																																																	
SS1	SC36 : SS1 drive control	Automatic	Automatic	Automatic																																																																																																	
	SC30 : SS1 commanded deceleration	20.0 Hz/s	20.0 Hz/s	20.0 Hz/s																																																																																																	
	SC31 : SS1 monitored deceleration	10.0 Hz/s	10.0 Hz/s	10.0 Hz/s																																																																																																	
	SC32 : SS1 offset	5.0 Hz	5.0 Hz	5.0 Hz																																																																																																	
	SC33 : SS1 standstill level	5.0 Hz	5.0 Hz	5.0 Hz																																																																																																	
	SC34 : SS1 delay before monitoring	5 ms	5 ms	5 ms																																																																																																	
	SC35 : SS1 violation restriction	Inactive	Inactive	Inactive																																																																																																	
	SC45 : P#SC45#L	Undefined	Undefined	Undefined																																																																																																	

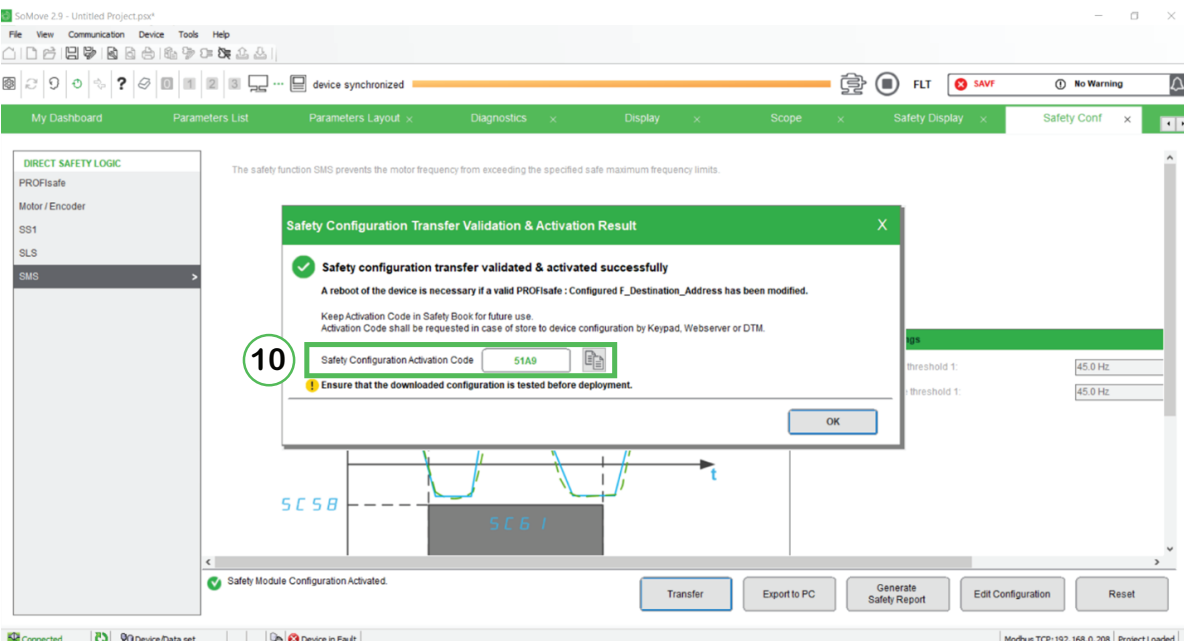
Step	Action
10	<p>After accepting the readback values, the safety configuration transfer is validated and activated successfully.</p>  <p>The safety function SMS prevents the motor frequency from exceeding the specified safe maximum frequency limits.</p> <p><b>Safety Configuration Transfer Validation &amp; Activation Result</b></p> <p>✓ Safety configuration transfer validated &amp; activated successfully</p> <p>A reboot of the device is necessary if a valid PROFIsafe : Configured F_Destination_Address has been modified.</p> <p>Keep Activation Code in Safety Book for future use. Activation Code shall be requested in case of store to device configuration by Keypad, Webserver or DTM.</p> <p>Safety Configuration Activation Code: 51A9</p> <p>⚠ Ensure that the downloaded configuration is tested before deployment.</p> <p>OK</p> <p>SC5B</p> <p>SC6I</p> <p>✓ Safety Module Configuration Activated.</p>

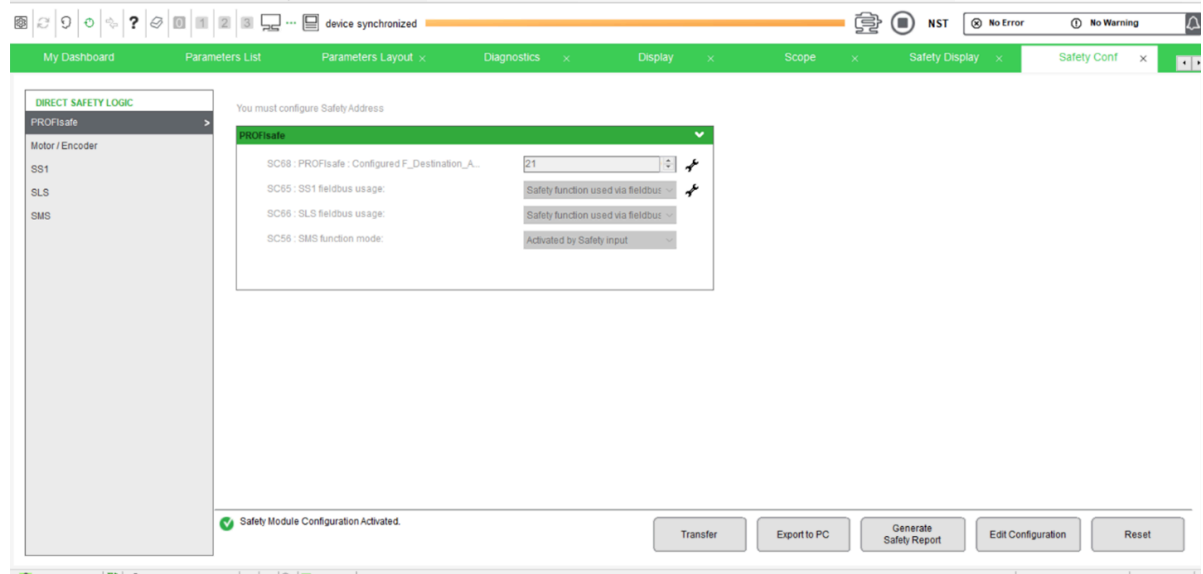
Step	Action
11	<p>Generate the safety report that includes the safety configuration activation code and the safety configuration done during the commissioning phase.</p> 

## PROFIsafe watchdog time

**▲ WARNING**

**LOSS OF CONTROL**

Verify that the setting of this parameter is suitable for the application by performing comprehensive commissioning tests for all load conditions and all potential error conditions.

**Failure to follow these instructions can result in death, serious injury, or equipment damage.**

Watchdog Time (**WDTime**) is the time between the reception of the last valid PROFIsafe telegram and the activation of a Safety function after the PROFIsafe timeout has elapsed.

For the calculation of the response time between the safety PLC and the safety drive, the PROFIsafe timeout **F\_WD\_Time** is considered in the event of an error (e.g., due to communication disturbances). The activation of the Safety function only occurs after this timeout has elapsed. It is calculated based on the following:  
 $WDTime = F\_WD\_Time \text{ (configured)} + WCDT \text{ (of safety function used)}$ .

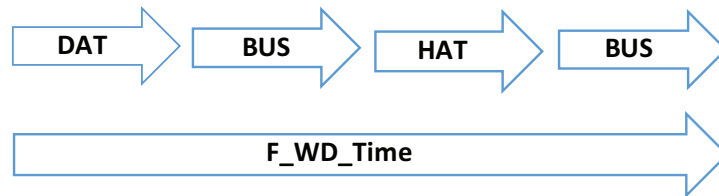

Bus transfer time: is the time it takes when the PROFIsafe frame is transmitted from the safety drive to the safety controller and vice versa. The bus transfer time must be calculated while considering the event of diagnosis messages.

Host acknowledgement time (**HAT**) : the time it takes for the safety controller to process an incoming PROFIsafe frame.

The value of **F\_WD\_Time** must be higher than the minimum watchdog time (the sum of **DAT**, **HAT** and two times the Bus time), and the difference in the two values must not exceed 30%.

Worst Case Delay Time (**WCDT**): Maximum response time between the arrival of a PROFIsafe telegram and the activation of the Safety function in the absence of an error.

Function	Response	WDCT value
STO	STO active	20 ms
SS1	STO active	20 ms + (Delay / Ramp deceleration parameter)
SLS	SLS monitoring active	20 ms + Deceleration Time
SMS	SMS monitoring active	20 ms

Device Acknowledgement Time (**DAT**): Time between the reception of a PROFIsafe telegram and the sending of a response to that telegram. It is set to a value of 12 ms.

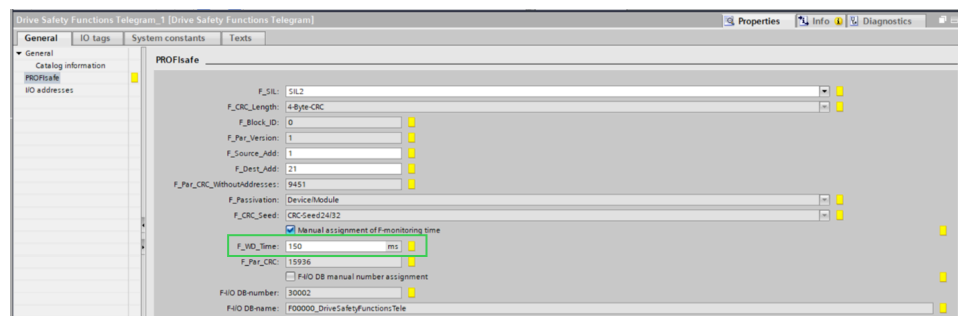

To activate the respective timeout errors according to PROFIsafe F\_WD\_Time and the PROFINet watchdog, their values must be sufficiently different, with the PROFIsafe F\_WD\_Time value higher than the PROFINet watchdog.

The Profinet Watchdog time is generally set to a few milliseconds, used to monitor the quality of packet transmission.

For example, by default, the Profinet Bus Cycle is 4 ms in the TIA portal, so the Profinet Watchdog could be set to 16 ms (4 times the bus cycle). The PROFIsafe Watchdog time (F\_WD\_Time) is generally set to several tens of milliseconds, calculated based on the values of DAT and HAT. By default, the F\_WD\_Time is 150 ms in the TI portal, but this value should be adapted by the customer according to the HAT and DAT values.

## Response time of the SLS/SMS safety functions

During the activation of the SLS/SMS functions and if the limits are exceeded, then the response time to reach STO must be considered: WCDT + response time.

Function	Response	Response Time when limits are exceeded	
		Safety configuration in closed loop (SIL 3)	Safety configuration in open loop (SIL 2)
<b>SLS</b>	STO active	100 ms	650 ms
<b>SMS</b>	STO active	100 ms	650 ms

## Motor / Encoder Configuration

The parameters show in the **Motor / Encoder** tab can be automatically filled according to the safety drive configuration by clicking on **Apply Motor & Encoder Config** button. Verify that the imported values correspond to your application (in case of STO only, this part is not accessible by the DTM).

**NOTE:** This tab is only visible if at least SS1 or SLS or SMS function is enabled via configuration of SC65, SC66 and SC56.

It is possible to fill them in manually. In this case, ensure that the settings are consistent with the safety drive configuration.

After a safety configuration transfer, if the motor and encoder parameters inside the safety drive configuration are modified (via the Graphic Display Terminal and/or via the commissioning software), the safety configuration must be performed again to remain consistent. Otherwise, the monitoring functions of the safety module will trigger an error.

**NOTE:** Check that the mechanical and electrical operation of the encoder, its power supply, and connections are all OK.

The following table shows the motor parameters used for the safety configuration:

Parameter	Description	Possible Values
<b>[Motor type]</b> SC01	Type of motor.  The value must be consistent with the setting of <b>[Motor control type]</b> CTT.  <b>NOTE:</b> Permanent Magnet Synchronous Motor can only be used with closed loop control.	Setting range: <ul style="list-style-type: none"> <li>Undefined</li> <li>Asynchronous Motor</li> <li>Permanent Magnet Synchronous Motor</li> </ul>
<b>[Motor pole pair number]</b> SC02	Number of pole pairs of the motor.	Setting range: <ul style="list-style-type: none"> <li>Undefined</li> <li>1...65,535 pole pairs</li> </ul>
<b>[Motor rotation inversion]</b> SC03	Output phase rotation.  The value must be consistent with the setting of <b>[Output Ph Rotation]</b> PHR.	Setting range: <ul style="list-style-type: none"> <li>Inactive</li> <li>Active</li> </ul>
<b>[Allowed frequency deviation]</b> SC04	Allowed motor frequency deviation.  Defines the maximum tolerated frequency difference between internal estimated/measured motor frequency.  The setting of this parameter depends on the application (frequency overshoot, inertia, acceleration, motor slip, etc.).  It is a compromised between robustness and reliability.	Setting range: 0...200.0 Hz  Step: 0.1 Hz  Factory setting: 2 Hz

The following table shows the settings of the motor parameters according to the type of motor and the type of loop control:

Parameter	Asynchronous motor		Permanent Magnet Synchronous motor
	Open loop <sup>(1)</sup>	Closed loop <sup>(2)</sup>	Closed loop <sup>(3)</sup>
<b>[Motor type]</b> SC01	Asynchronous motor		Permanent Magnet Synchronous motor
<b>[Motor pole pair number]</b> SC02	This parameter must be set to the closest integer equal to or less than: $60 * FRS / NSP$ With <b>[Nominal Motor Freq]</b> FRS and <b>[Nominal Motor Speed]</b> NSP Example: FRS = 50 Hz and NSP = 1460 rpm then SC02 = 2		This parameter must be set to the same value as <b>[Pole pairs]</b> PPNS.
<b>[Motor rotation inversion]</b> SC03	<ul style="list-style-type: none"> <li>Inactive: If <b>[Output Ph Rotation]</b> PHR is set to <b>[ABC]</b> ABC.</li> <li>Active: If <b>[Output Ph Rotation]</b> PHR is set to <b>[ABC]</b> ABC</li> </ul>		
<b>[Allowed frequency deviation]</b> SC04	If required, modify the value depending on the application: it may be reduced close to 0 Hz.	If required, modify the value depending on the application: it must be greater than the slip of the motor.	If required, modify the value depending on the application: it may be reduced close to 0 Hz.
(1): If <b>[Motor control type]</b> CTT is set to <b>[SVC V]</b> VVC, <b>[U/F VC 5pts]</b> UF5, <b>[Energy Sav.]</b> NLD. (2): If <b>[Motor control type]</b> CTT is set to <b>[FVC]</b> FVC. (3): If <b>[Motor control type]</b> CTT is set to <b>[Sync.CL]</b> FSY.			

The following table shows the encoder parameters used for the safety configuration:

Parameter	Description	Possible Values
<b>[Encoder type]</b> SC05	Type of encoder.	<ul style="list-style-type: none"> <li>Undefined</li> <li>No encoder used</li> <li>AB or HTL option module</li> <li>EnDat2.2 option module</li> <li>SSI option module</li> <li>SinCos option module</li> <li>AB Embedded</li> <li>SinCos embedded</li> </ul>
<b>[Encoder resolution]</b> SC06	Resolution of encoder.	Setting range (the unit depends on the type of encoder). <ul style="list-style-type: none"> <li>undefined</li> <li>1...65,535</li> </ul>
<b>[Encoder rotation inversion]</b> SC07	Inversion of encoder rotation direction.  The setting of this parameter must be consistent with the setting of <b>[Encoder rotation inv.]</b> ENRI or the setting of <b>[Emb Enc Rotation Inv]</b> EERI depending on the encoder used.	<ul style="list-style-type: none"> <li>Inactive</li> <li>Active</li> </ul>

The following tables show the settings of the encoder parameters according to the type of encoder and the type of control loop if an encoder option module is used:

**NOTE:** In case of open loop, **[Encoder type] SC05** must be set to **No encoder used** and the parameters **[Encoder resolution] SC06** and **[Encoder rotation inversion] SC07** are not set. In this case, the safety drive parameters **[Emb Enc Usage] EENU** and **[Encoder usage] ENU** and **[Emb Enc Rotation Inv] EERI** and **[Encoder rotation inv.] ENRI** must be configured to a setting different from **[Speed Regulation] REG**.

	Parameters	Closed loop		
If	<b>[Encoder Type] UECP</b>	<b>[SSI] SSI</b>	<b>[EnDat 2.2] EN22</b>	<b>[SinCos] SC</b>
	<b>[Encoder usage] ENU</b>	<b>[Speed Regulation] REG</b>		
Then	<b>[Encoder type] SC05</b>	SSI option module	EnDat2.2 option module	SinCos option module
	<b>[Encoder resolution] SC06</b>	Must be set to <b>[Turn bit resolution] ENTR</b> value	The number of bits per revolution must be entered manually	Must manually be set to <b>[Sincos lines count] UELC</b> value
	<b>[Encoder rotation inversion] SC07</b>	<ul style="list-style-type: none"> <li>Inactive: If <b>[Encoder rotation inv.] ENRI</b> is set to <b>[No] NO</b>.</li> <li>Active: If <b>[Encoder rotation inv.] ENRI</b> is set to <b>[Yes] YES</b>.</li> </ul>		

	Parameters	Closed loop		
If	<b>[Encoder Type] UECP</b>	<b>[Hiperface] SCHP</b>	<b>[AB] AB</b>	<b>[HTL] HTL</b>
	<b>[Encoder usage] ENU</b>	<b>[Speed Regulation] REG</b>		
Then	<b>[Encoder type] SC05</b>	SinCos option module	AB or HTL option module	
	<b>[Encoder resolution] SC06</b>	The number of lines must be entered manually.	Must be set to <b>[Number of pulses] PGI</b> value	
	<b>[Encoder rotation inversion] SC07</b>	<ul style="list-style-type: none"> <li>Inactive: If <b>[Encoder rotation inv.] ENRI</b> is set to <b>[No] NO</b>.</li> <li>Active: If <b>[Encoder rotation inv.] ENRI</b> is set to <b>[Yes] YES</b>.</li> </ul>		

The following table shows the settings of the encoder parameters according to the type of encoder and the type of control loop if an embedded encoder is used:

	Parameters	Closed loop	
If	<b>[Emb Enc Type] EECP</b>	<b>[AB] AB</b>	<b>[SinCos] SC</b>
	<b>[Emb Enc Usage] EENU</b>	<b>[Speed Regulation] REG</b>	
Then	<b>[Encoder type] SC05</b>	AB embedded	SinCos embedded
	<b>[Encoder resolution] SC06</b>	Must be set to <b>[Emb Enc Pulses Nb] EPGI</b> value	Must be set to <b>[Emb Enc Sincos lines] EELC</b> value
	<b>[Encoder rotation inversion] SC07</b>	<ul style="list-style-type: none"> <li>Inactive: If <b>[Encoder rotation inv.] ENRI</b> is set to <b>[No] NO</b>.</li> <li>Active: If <b>[Encoder rotation inv.] ENRI</b> is set to <b>[Yes] YES</b>.</li> </ul>	

# Transfer

After the activation code is entered at the Graphic Display Terminal, the drive may transition automatically to the operating state *Operation Enabled*. Depending on the wiring and the configuration of the drive, this may result in immediate operation.

**⚠ WARNING**

**UNANTICIPATED EQUIPMENT OPERATION**

- Verify that there are no persons or obstructions in the zone of operation before entering the activation code at the Graphic Display Terminal.
- Verify that you are fully aware of all consequences of entering the operating state *Operation Enabled*.

**Failure to follow these instructions can result in death, serious injury, or equipment damage.**

**NOTE:** the activation code is not requested in case of a safety configuration transfer.

The Transfer button allows you to transfer the safety configuration to the device and compare the safety configuration data retrieved from the safety module with the safety data configured in the DTM.

**NOTES:**

- During the configuration transfer, the device can be located using the ASF LED.
- The Transfer button is enabled when :
  - All the mandatory conditions are met.
  - The device is connected to the DTM.

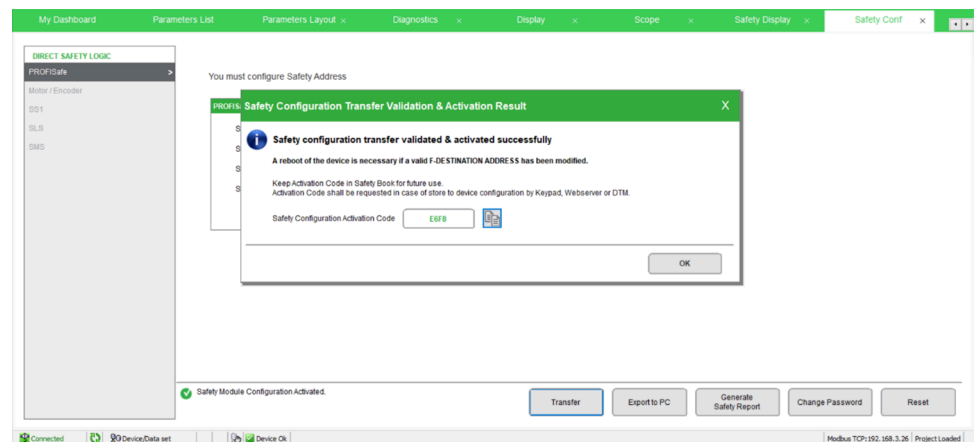

The activation code is displayed after the approval and activation code should be saved by the customer for a future safety configuration cloning via display terminal.

**NOTES:**

- The safety functions (SS1,SLS,SMS) must be deactivated through the safety telegram output before transferring the configuration.
- IPAR configuration transfer is not compatible with the use of the safety module.
- When the PROFIsafe communication is running, before the safety configuration, it is recommended to activate the STO function through the bit Safe Torque Off of the Safety Output Telegram.

# Acceptance Test

## Overview

The system integrator/machine manufacturer performs a configuration test of the PROFIsafe module to verify and document the correct selection of the parameter values. The system integrator/machine manufacturer hereby certifies to have tested the effectiveness of the safety functions used. The configuration test must be performed on the basis of the risk analysis. All applicable standards and regulations must be adhered to.

### **⚠ WARNING**

#### **LOSS OF SAFETY FUNCTION**

Incorrect usage may cause a hazard due to the loss of the safety function.

- Verify that the engineering prerequisites still apply.
- Carefully perform each individual step.
- Document each individual step.

**Failure to follow these instructions can result in death, serious injury, or equipment damage.**

The purpose of the test is to verify proper configuration of the defined safety functions and test mechanisms and to examine the response of dedicated monitoring functions to explicit input of values outside the tolerance limits.

The test must cover all specific safety drive configured monitoring functions and global safety functionality of the safety drive with the PROFIsafe module.

An acceptance test of the PROFIsafe module must be performed at the following points in time:

- After the configuration for each machine,
- After changes to parameter values,
- After changes to the machine (as per applicable standards and regulations).

## Condition Prior to Acceptance Test

- The machine is wired up correctly.
- All motor parameters and command parameters must be correctly set on the safety drive.
- The connection has been established between the safety controller and the safety drive.

## Acceptance Test Process

Verify the effectiveness of all safety functions used.

Document each individual step of the test.

Do not release the system unless the system has successfully passed all individual steps of the test.

The following steps can be executed for the system test:

Communication test: by verifying the safety telegram to confirm that the communication is properly established.

Application test:

- Start the motor and activate the safety functions according to the application.
- For each safety function:
  - Activate and deactivate via the safety telegram output and verify the status of the telegram Input.
  - Verify that the motor behavior is consistent with the application.
- Verify the status of safety drive through the safety menu on the display terminal.

Safety validation of the application test: Consists on validating the application following the Safety Test Procedure defined by the system integrator/machine manufacturer.

**NOTE:** The safety configuration test function can help to test the safety functions, refer to **[Safety Config Test]** [SCT](#) menu, page 77.

## Generate Safety Report

This feature has been added as an optional document to be printed to a PDF file. It generates a safety report when one or several safety functions have been configured and verified.

It contains the activation code and information of the safety configuration. This report is deemed to be a machine signature and certifies that all the safety functions are operational.

The report must only be generated if all individual steps of the tests has successfully been passed.

If the safety drive configuration and/or the safety module configuration has/have been modified, the safety report is no more verified. The acceptance tests must be repeated, and the safety report must be generated again.

Generate Safety Report button is enabled in the following cases:

- Online, if the safety configuration has been transferred to the connected safety drive and activated. In this case, the button remains enabled even if the safety drive is disconnected to the commissioning software.

However, in case of modification of the safety configuration displayed on the DTM, the button is disabled.

- Offline, if the current session uses a SoMove Project File (.psx) of a previously activated safety configuration. No modification of the configuration must have been performed. It is possible to generate the safety report in read-only mode.

# Operation with PROFIsafe

After configuring the safety drive, the drive displays a STO state.

The safety drive is in STO state by default. To deactivate the STO and allow the torque to run the motor, a safety controller must be connected and configured to open the connection between the safety controller and safety drive.

## ⚠ WARNING

### UNANTICIPATED EQUIPMENT OPERATION

Verify that having a control command active on level cannot result in unsafe condition after having disabled STO.

**Failure to follow these instructions can result in death, serious injury, or equipment damage.**

**NOTE:** for the applications that require it, a manual acknowledgment of the control command activation on level can only be programmed in the safety controller.

The command from the PLC to the safety drive can be enabled through the setting of the safety telegram input and output bits:

#### Input:

Parameter	Byte	Attribute (bit)	Description
Torque disabled	0	0	1= Torque disabled 0= Torque permitted
Reserved		1	Reserved, must be set to 0.
SS1 active		2	1= SS1 active
Reserved		3	Reserved, must be set to 0.
Reserved		4	Reserved, must be set to 0.
Reserved		5	Reserved, must be set to 0.
Safety error		6	1= Safety error present 0= No error
Restart Required (1)		7	Indicate if a safety stop function is active and waiting for a restart: 0: Restart not required 1: Restart required
SLS Active	1	1	1= SLS is active
Reserved		2	Reserved, must be set to 0.
Reserved		3	Reserved, must be set to 0.
Reserved		4	Reserved, must be set to 0.
Reserved		5	Reserved, must be set to 0.
SMS Active		6	1= SMS is active
Active SMS threshold		7	0= SMS threshold 1 1= SMS threshold 2
(1) Informative only. Can't be used by [PROFIsafe Controller] to decide safety-related action.			

**Output:**

Parameter	Byte	Attribute (bit)	Description
Safety Torque Off	0	0	1= Permit Torque 0= Disable Torque
Reserved		1	Reserved, must be set to 0.
SS1 Request		2	1= Activate SS1 0= Deactivate SS1
Reserved		3	Reserved, must be set to 0.
Reserved		4	Reserved, must be set to 0.
Reserved		5	Reserved, must be set to 0.
Reserved		6	Reserved, must be set to 0.
Safety Reset		7	0 → 1 = Reset PROFIsafe error
SLS Request	1	1	1= Activate SLS 0= Deactivate SLS
Reserved		2	Reserved, must be set to 0.
Reserved		3	Reserved, must be set to 0.
Reserved		4	Reserved, must be set to 0.
Reserved		5	Reserved, must be set to 0.
SMS Switch		6	Switch between operating modes of SMS function, see details in Safety Function SMS (Safe Maximum Speed), page 57.
Reserved		7	Reserved, must be set to 0.

The safety controller is responsible for activating/deactivating the safety functions of the safety drive when the communication is opened through the safety output telegram. When no safety output telegram has been exchanged between the safety drive and controller, the safety drive activates the STO function by default.

When the safety controller is stopped, the PROFInet communication is lost and **[Fieldbus Com Interrupt] CNF** is triggered when PROFInet is the active command channel. The **[PROFIsafe Com State] SSM1** is in **[Stopped] S006** state and STO function is activated.

The timeout error is triggered when the time between cyclic exchanges have exceeded the PROFIsafe timeout or the safety drive timeout. The first triggered timeout is the one taking effect.

When the PROFInet watchdog is lower than PROFIsafe watchdog and **[Ref Freq 1 Config] FR1** is set to a value different than **[Ref. Freq-Com. Module] NET**, the **[Safety IO Error] SIOF** error is not triggered if the profinet cable has been unplugged.

# Diagnostics and Troubleshooting

## What's in This Part

Operating states.....	101
Detected Errors.....	102

# Operating states

The table provides the different operating states for the PROFIsafe module:

Name	Description
[Starting]	Initialization ongoing but not completed.
[Not Rdy To Switch On]	PROFIsafe module initialization is completed.
[Switch On Disabled]	Safety drive initialization is completed but PROFIsafe controller has not started validating the cyclical exchanges.
[Ready To Switch On]	Configuration of PROFIsafe module is completed.
[Operation Enabled]	Safety drive is in operational mode. STO is deactivated.
[Fault]	Safety error triggered.
[STO Active]	Safety function STO is active.
[SS1 Active]	Indicates that the safety function SS1 is triggered (for example, due to the emergency stop via an actuator).

**NOTE:** The PROFIsafe module operating state machine is different from the safety drive operating state machine.

# Detected Errors

## Overview

The safety-related errors are classified as follows

- **SIOF**: Safety-related IO errors.
- **SAVF**: Safety function violation error.
- **SCFF**: Safety-related configuration error.
- **INFI**: **[Internal Error 18]**.

When an error is detected by the PROFIsafe module, the drive displays one of the previous errors depending on the cause(s).

This detected error is completed with one or several error codes in order to provide more information on the probable causes and remedies.

The error codes can be accessed by scrolling at the bottom of the window displayed on the Display Terminal when an error is triggered. They can also be accessed in the menu **[Complete settings] CST** → **[Safety Module] OSM** → **[Safety Module Error] SMLE** for the drive errors and **[Safety Module Errors] SME** for the safety module errors or via the Safety Display tab of the commissioning software. The "i" info button of the display terminal gives access to detailed troubleshooting messages.

**NOTE:** If several errors are detected simultaneously, the first detected error defines which safety related error code will be displayed.

## Device fault behavior

The PROFIsafe device\_Fault of status byte is always set to 0. When a class 4 error occurs, the PROFIsafe communication is stopped by the safety drive.

## Error Class

The PROFIsafe module triggers errors. The errors can be grouped by classes as following:

Error Class	Stop category (as per IEC 60204)	Description
0	–	Warning: an event has been detected. No interruption of the movement.
2	0	An error has been detected. The safety function STO is triggered and the power stage is immediately disabled.  Error class 2 could be resettable.
3	0	An error has been detected. The safety function STO is triggered and the power stage is immediately disabled.  Errors class 3 could be resettable.
4	0	An error has been detected. The safety function STO is triggered and the power stage is immediately disabled.  Errors class 4 are non-resettable.

## PROFIsafe Error Reset

**Resettable error:** After the cause has been removed, this detected error can be cleared via:

- PROFIsafe telegram (safety output telegram) or a power cycle of the safety drive when the safety connection between the safety drive and the safety controller is established.

**NOTE:** PROFIsafe telegram does not clear the drive resettable errors not linked to the PROFIsafe module.

- Assignment of **[Fault Reset Assign]** [RSF](#) function or Bit related to fault reset of **[Cmd Register]** [CMD](#) or a power cycle when the safety connection between the safety drive and the safety controller is not in data exchange state.

**Non-resettable error:** After removing the cause, this detected error requires a power cycle of the drive to be cleared.

**Note:**



- **[Product restart]** [RP](#) or **[Prod Restart Assign]** [RPA](#) is equivalent to a power cycle. When using this feature to clear the safety error, the safety drive takes longer time to be in RDY state mode than a standard drive (with no PROFIsafe module) (more details of the parameters in the [ATV340 Programming manual](#)).
- If a resettable error and a non-resettable error are detected at the same time, the non-resettable error cannot be reset manually. After removing the causes, these detected errors require a power cycle of the drive to be cleared.
- When an error is triggered by the PROFIsafe module, it is communicated to the drive. Similarly, the drive can also trigger an error.



If both the drive and the PROFIsafe module detect an error, and the safety error is cleared via the safety output telegram, it is necessary to clear the drive error separately by performing a power cycle or using **[Fault reset]** [RST](#).

It is possible that the same cause triggers errors in both the drive and the PROFIsafe module.

## [Safety IO Error] SIOF errors

The table provides the list [Safety IO Error] SIOF detected errors

Error Code	Decimal value	Probable Cause 	Remedy 	Error Class
<b>[PROFIsafe COM Error]</b> <a href="#">SME147</a>	327	PROFIsafe communication integrity error <ul style="list-style-type: none"> <li>Electromagnetic disturbances on network</li> <li>Inoperative network equipment corrupting messages</li> <li>Inoperative network equipment misrouting messages</li> </ul>	<ul style="list-style-type: none"> <li>Verify the environment (electromagnetic compatibility)</li> <li>Verify and replace network equipment if needed</li> <li>Contact your local Schneider Electric representative.</li> </ul>	2
<b>[PROFIsafe Timeout]</b> <a href="#">SME153</a>	339	<ul style="list-style-type: none"> <li>Communication loss</li> <li>Cable unplugged</li> <li>No safety telegrams are received</li> </ul>	Verify and replace network equipment if needed	2
<b>[Internal 24V OverV]</b> <a href="#">SME060</a>	96	Internal 24Vdc overvoltage	Contact your Schneider Electric Customer Care Center (CCC).	2
<b>[Internal 24V UnderV]</b> <a href="#">SME06D</a>	109	Internal 24Vdc undervoltage.	Contact your Schneider Electric Customer Care Center (CCC).	2
<b>[Unexpected STO]</b> <a href="#">SME0D4</a>	212	<ul style="list-style-type: none"> <li>STO is requested from Drive terminal.</li> <li>The safety module has detected an error on STO circuitry</li> </ul>	<ul style="list-style-type: none"> <li>Verify that drive STO_A and STO_B are wired to 24V.</li> <li>Contact your local Schneider Electric representative.</li> </ul>	3
<b>[SinCos Embd Signal]</b> <a href="#">SME070</a>	112	SinCos embedded signal. Detected error on encoder signals.	Verify the encoder and its wiring.	3
<b>[SinCos Opt Signal]</b> <a href="#">SME093</a>	147	SinCos option module signal. Detected error on encoder signals.	Verify the encoder module, the encoder and its wiring.	3
<b>[Encoder Error]</b> <a href="#">SME094</a>	148	Encoder error.	Verify the encoder module, the encoder and its wiring.	3
<b>[Enc Signal Overcur]</b> <a href="#">SME095</a>	149	Encoder signal overcurrent.	Verify the encoder module, the encoder and its wiring.	3
<b>[Encoder Signal Spike]</b> <a href="#">SME096</a>	150	Encoder signal spike.	Verify the encoder module, the encoder and its wiring.	3
<b>[Enc Channel A Open]</b> <a href="#">SME0B9</a>	185	Encoder channel A is open	Verify the encoder module, the encoder and its wiring.	3
<b>[Enc Channel B Open]</b> <a href="#">SME0BA</a>	186	Encoder channel B is open	Verify the encoder module, the encoder and its wiring.	3
<b>[Endat RCV1 Error]</b> <a href="#">SME0BD</a>	189	Endat RCV1 error	Verify the encoder module, the encoder and its wiring.	4

Error Code	Decimal value	Probable Cause 	Remedy 	Error Class
<b>[Endat ERR1 Error]</b> SME0BE	190	Endat ERR1 error	Verify the encoder module, the encoder and its wiring.	4
<b>[Endat CRCPTY Error]</b> SME0BF	191	Endat CRCPTY error	Verify the encoder module, the encoder and its wiring.	4
<b>[Endat MSADR Error]</b> SME0C0	192	Endat MSADR error	Verify the encoder module, the encoder and its wiring.	4
<b>[Endat ERR2 Error]</b> SME0C1	193	Endat ERR2 error	Verify the encoder module, the encoder and its wiring.	4
<b>[Endat WDOG Error]</b> SME0C2	194	Endat watchdog error	Verify the encoder module, the encoder and its wiring.	4
<b>[Endat Power Error]</b> SME0C3	195	Endat power error	Verify the encoder module, the encoder and its wiring.	4
<b>[Resolver Speed Error]</b> SME0C9	201	Speed exceeds maximum tracking rate	Verify the encoder module, the encoder and its wiring.	4
<b>[Resolver Signal Error]</b> SME0CB	203	Sine signal and Cosine signal are inconsistent	Verify the encoder module, the encoder and its wiring.	4
<b>[Resolver Signal Error]</b> SME0CC	204	Sine signal or Cosine signal is out of range	Verify the encoder module, the encoder and its wiring.	4
<b>[Resolver Signal Error]</b> SME0CD	205	Sine signal or Cosine signal is lost	Verify the encoder module, the encoder and its wiring.	4
<b>[Resolver Signal Error]</b> SME0CE	206	Sine signal or Cosine signal is clipped	Verify the encoder module, the encoder and its wiring.	4
<b>[AB Embd Wirebreak]</b> SME0E2	226	AB embedded encoder wirebreak.	Verify the encoder and its wiring.	4

## [Safety Violation] SAVF errors



The table provides the list [Safety Config Error] SCFF detected errors

Error Code	Decimal value	Probable Cause 	Remedy 	Error Class
[SS1 Ramp Violation] SME011	17	Insufficient motor deceleration during SS1	<ul style="list-style-type: none"> <li>Verify the drive and machine configuration.</li> <li>Verify the motor frequency.</li> </ul>	3
[Low Temp Warn] SME01C	28	Temperature exceeds lower limit (warning).	Verify environment temperature	0
[High Temp Warn] SME01D	29	Temperature exceeds upper limit (warning).	Verify environment temperature	0
[Motor Freq Deviation] SME02C	44	The monitored motor frequency is different channel A and channel B.	<ul style="list-style-type: none"> <li>Verify the safety module motor and encoder parameters.</li> <li>Verify the drive control loop settings.</li> <li>Replace the safety Module.</li> </ul>	3
[Low Temp Error] SME05F	95	Temperature exceeds lower limit.	Verify environment temperature.	4
[High Temp Error] SME061	97	Temperature exceeds upper limit.	Verify environment temperature.	4
[SS1 Repeat Violation] SME068	104	Maximum number of SS1 ramp violations has been reached	<ul style="list-style-type: none"> <li>Verify the drive and machine configuration.</li> <li>Verify the motor frequency.</li> </ul>	4
[Sfty Fct in Freewheel] SME071	113	Safety function activated in freewheel.	Contact your Schneider Electric Customer Care Center (CCC).	3
[Monit Ramp Violation] SME0A9	169	Insufficient motor deceleration during monitored ramp	<ul style="list-style-type: none"> <li>Verify the drive and machine configuration.</li> <li>Verify the motor frequency.</li> </ul>	3
[SLS Thd Violation] SME0AB	171	Motor frequency exceeds SLS threshold	<ul style="list-style-type: none"> <li>Verify the drive and machine configuration.</li> <li>Verify the motor frequency.</li> </ul>	3
[SMS Pos Violation] SME0B4	180	Motor frequency exceeds SMS positive threshold (violation response: STO with error)	<ul style="list-style-type: none"> <li>Verify the drive and machine configuration.</li> <li>Verify the motor frequency.</li> </ul>	3
[SMS Neg Violation] SME0B5	181	Motor frequency exceeds SMS negative threshold (violation response: STO with error)	<ul style="list-style-type: none"> <li>Verify the drive and machine configuration.</li> <li>Verify the motor frequency.</li> </ul>	3
[Unallowed IGBT Test] SME0DC	220	Unallowed IGBT tests have been detected by safety module	Contact your Schneider Electric Customer Care Center (CCC).	3



## [Safety Config Error] SCFF errors

The table provides the list [Safety Config Error] SCFF detected errors

Error Code	Decimal value	Probable Cause 	Remedy 	Error Class
<b>[Corrupted Config]</b> <a href="#">SME032</a>	50	Corrupted configuration.	Contact your Schneider Electric Customer Care Center (CCC).	4
<b>[Board Compatibility]</b> <a href="#">SME0F4</a>	244	Drive control board is incompatible with safety module.	Contact your Schneider Electric Customer Care Center (CCC).	4
<b>[PROFIsafe Rsvd Bit Usage]</b> <a href="#">SME152</a>	338	Reserved output bit of telegram is set.	Verify the PLC program	2
<b>[SS1 PROFIsafe Conf]</b> <a href="#">SME156</a>	342	<ul style="list-style-type: none"> <li>Function SS1 is requested via PROFIsafe F-Output data although the activation of SS1 is not configured</li> <li>Mistake in safety controller program</li> <li>Wrong configuration in PROFIsafe module</li> </ul>	<ul style="list-style-type: none"> <li>Verify the safety controller program</li> <li>Verify the PROFIsafe module configuration</li> </ul>	2
<b>[SLS PROFIsafe Conf]</b> <a href="#">SME157</a>	343	<ul style="list-style-type: none"> <li>Function SLS is requested via PROFIsafe F-Output data although the activation of SS1 is not configured</li> <li>Mistake in safety controller program</li> <li>Wrong configuration in PROFIsafe module</li> </ul>	<ul style="list-style-type: none"> <li>Verify the safety controller program</li> <li>Verify the PROFIsafe module configuration</li> </ul>	2
<b>[SMS PROFIsafe Conf]</b> <a href="#">SME158</a>	344	<ul style="list-style-type: none"> <li>Function SMS is requested via PROFIsafe F-Output data although the activation of SS1 is not configured</li> <li>Mistake in safety controller program</li> <li>Wrong configuration in PROFIsafe module</li> </ul>	<ul style="list-style-type: none"> <li>Verify the safety controller program</li> <li>Verify the PROFIsafe module configuration</li> </ul>	2
<b>[Config Dwnld Timeout]</b> <a href="#">SME019</a>	25	Transfer error between drive and module.	Try downloading the configuration again.	0
<b>[Config Dwnld Error]</b> <a href="#">SME01B</a>	27	Configuration download error.	Contact your Schneider Electric Customer Care Center (CCC).	0
<b>[Conf Transfer Aborted]</b> <a href="#">SME02D</a>	45	Configuration transfer aborted.	Contact your Schneider Electric Customer Care Center (CCC).	3
<b>[Incompatible Version]</b> <a href="#">SME0D9</a>	217	The safety module software and the drive software are incompatible.	<ul style="list-style-type: none"> <li>Verify the compatibility software version of the drive and the safety module.</li> <li>Contact your local Schneider Electric representative.</li> </ul>	4

Error Code	Decimal value	Probable Cause 	Remedy 	Error Class
<b>[Motor Ph Inversion]</b> SME0DA	218	Safety module and Drive motor phase inversion configurations are inconsistent.	Verify safety module and drive configuration.	3
<b>[Encoder Inversion]</b> SME0DB	219	Safety module and Drive encoder inversion configurations are inconsistent.	Verify safety module and drive configuration.	3
<b>[Incompat Enc Option]</b> SME0F3	243	Encoder module is incompatible with safety module.	Contact your Schneider Electric Customer Care Center (CCC).	4
<b>[Board Compatibility]</b> SME0F4	244	Drive control board is incompatible with safety module.	Contact your Schneider Electric Customer Care Center (CCC).	4

## [Internal Error 6] INF6 error



Error Code	Probable Cause 	Remedy 
<b>[Internal Error 6]</b> INF6	<ul style="list-style-type: none"> <li>The option module installed in the drive is not recognized.</li> <li>The drive firmware version is not compatible with the PROFIsafe module</li> </ul>	<ul style="list-style-type: none"> <li>Verify the catalog number and compatibility of the option module.</li> <li>Update the Firmware version.</li> </ul>

For more details about detected errors, contact your local Schneider representative.

To access the probable causes and remedies for the errors triggered by the PROFIsafe module on the Graphic Display Terminal, navigate to **[Safety Module Error x] SME<sub>x</sub>** (for more information, refer to *Dedicated Safety Function* menu in the Display Terminal) using the Graphic Display Terminal and then press the "i" button. A Cause & Remedy message is displayed.

## [Internal Error 18] INF1 errors

The table provides the list of **[Internal Error 18] INF1** detected errors

Error Code	Decimal value	Probable Cause 	Remedy 	Error Class
<b>[Incoherent Mot Curr]</b> SME0DF	223	Incoherent Motor Current.	Contact your Schneider Electric Customer Care Center (CCC).	4
<b>[Motor Overcurrent]</b> SME0EC	236	Motor Overcurrent.	Contact your Schneider Electric Customer Care Center (CCC).	4

For more details about detected errors **[Internal Error 18] INF1**, contact your local Schneider representative.

## [Safety Module Error] SMLE

The following table shows the dedicated errors displayed via **[Safety Module Error] SMLE** parameter:

Value range	Description
<b>[Internal Com Error 1]</b> CRCA	Acyclic data CRC.
<b>[Internal Com Error 2]</b> CRCC	Cyclic data CRC.
<b>[Internal Com Error 3]</b> WTB	Wrong toggle bit.
<b>[Conf Download Error1]</b> DSEQ	Error during download sequence.
<b>[Conf Download Error2]</b> VSEQ	Error during validation sequence.
<b>[Internal Com Error 4]</b> TUNN	Wrong tunneling data.
<b>[Cfg Readback Error]</b> RBAK	Error during configuration readback sequence.
<b>[Conf Download Error3]</b> DCNF	Download configuration error.
<b>[Partial Conf Transfer 2]</b> NSCF	Safety custom file missing/invalid.
<b>[Pairing Error 2]</b> WSCE	Password pairing error drive/module.
<b>[Partial Conf Transfer 1]</b> NOCF	Configuration file missing/invalid.
<b>[Pairing Error 1]</b> WCF	Configuration CRC pairing error drive/module.
<b>[Internal Conf Error]</b> PCNF	Internal issue with safety custom file.
<b>[Invalid Motor Conf]</b> WCCF	Wrong control motor law.

# Maintenance and decommissioning

## What's in This Part

Remove or replace the safety drive .....	111
Remove or replace the safety controller .....	112
Clone the safety drive .....	113
Decommission the safety drive .....	114

## Safety instructions

<b>▲ WARNING</b>
<b>UNANTICIPATED EQUIPMENT OPERATION</b> <ul style="list-style-type: none"><li>• Carefully follow the instructions given in this chapter.</li><li>• Do not operate the Safety drive with unknown or unsuitable settings or data.</li><li>• Perform a comprehensive commissioning test to verify that modification of the hardware has been done properly.</li></ul> <b>Failure to follow these instructions can result in death, serious injury, or equipment damage.</b>

## Remove or replace the safety drive

The safety drive configuration must be saved during the commissioning part into using Somove/DTM (for more information refer to DTM online help) or using Graphic Display Terminal, the firmware version of the new drive is compatible with PROFIsafe (**V4.3**):

- Power off the safety drive.
- Unplug the PROFIsafe module from the drive.
- Mount the new drive onto the safety system and plug the PROFIsafe module.
- Power on the new safety drive.
- If the configuration has been saved using SoMove/DTM:
  - Select Edit Connection/Scan and scan to discover the safety drive through the IPv4.
  - In the Safety Conf tab, click Transfer button which opens the Locate Device box. After locating the device, the safety configuration Readback Values must be verified and accepted, once accepted, the safety configuration is transferred and activated, and the displayed activation code must be copied and stored.
- If the configuration has been saved using the display terminal or webserver:
  - Restore the configuration using the "Copy to the device" function.
  - Restart the safety drive.
- If the safety module of a configured safety drive has been inserted in another configured drive, the safety configuration is deleted from both the drive and the safety module and no error is triggered.

The safety drive is now ready to establish the connection with the safety controller.

## Remove or replace the safety controller

To replace the safety controller:

- Power off the safety controller.
- Uninstall the safety controller.
- Mount the new safety controller.
- Reset the Safety Configuration of the safety drive by navigating in the Keypad menu "Safety Config Reset" if the new safety controller program has been modified.
- Power on the safety controller
- Restores the safety controller configuration using TIA Portal and its saved project.
- Restore the safety configuration using SoMove/DTM:

In the Safety Conf tab, click Transfer button which opens the Locate Device box. After locating the device, the safety configuration Readback Values must be verified and accepted, once accepted, the safety configuration is transferred and activated, and the displayed activation code must be copied and stored.

# Clone the safety drive

Verify that the firmware version of the drive is compatible with PROFIsafe module (**V4.3**), otherwise a firmware update is required.

To clone the safety drive:

- If the safety drive configuration is previously saved on:
  - Enter the safety activation code displayed during the transfer. If lost, connect to the DTM and do a transfer of the configuration to get the same activation code at the end.
  - Display terminal:
    - Restore the safety drive configuration.
    - Restart the safety drive.
  - SoMove or Webserver:
    - Restore the safety drive configuration, see ATV340 DTM online help for more details on how to restore a drive configuration.
    - Connect to the safety drive. Restart the safety drive.
- The safety drive safety functions are now activated and ready to connect to the safety controller.

**NOTE:** the F\_address of the new cloned safety drive must be modified to have a unique F\_address on the network.

**NOTE:** The activation of a safety configuration must be executed via a local connection.

## Decommission the safety drive

Consider performing decommissioning at the end of the device's lifecycle as a recommended practice.

The process of decommissioning the safety drive involves resetting the safety and non-safety configuration.

First the safety configuration must be reset through the "Reset safety Configuration" menu on the display terminal..

After this step is completed, the drive configuration can be reset by selecting the **[Go to Factory Settings]** GFS in the **[File management]** → **[Factory settings]** menu on the Display Terminal several screens to consider are displayed.

### **⚠ WARNING**

#### **UNANTICIPATED EQUIPMENT OPERATION**

Verify that activating this function does not result in unsafe conditions.

**Failure to follow these instructions can result in death, serious injury, or equipment damage.**

# Glossary

## D

### DTM:

Device Type Manager

A DTM is a device driver running on the host PC. It provides a unified structure for accessing device parameters, configuring, and operating the devices, and troubleshooting devices. DTMs can range from a simple graphical user interface (GUI) for setting device parameters to a highly sophisticated application capable of performing complex real-time calculations for diagnosis and maintenance purposes. In the context of a DTM, a device can be a communications module or a remote device on the network.

## G

### GSDML:

The GSDML (General Station Description Markup Language) is an XML based description language for PROFINET Devices.

## P

### PLC:

Programmable logic controller.

### PTI:

(Proof Test Interval) Periodic test performed to detect failures in a safety-related system

Schneider Electric  
35 rue Joseph Monier  
92500 Rueil-Malmaison  
France

+ 33 (0) 1 41 29 70 00

[www.se.com](http://www.se.com)

As standards, specifications, and design change from time to time, please ask for confirmation of the information given in this publication.

© 2025 Schneider Electric. All rights reserved.

BRU32661.01